



You're home.™

Mach

Pet

Let's get started



C85-MQ-Pe

vax.co.uk

Let's talk safety



Basic safety precautions

This vacuum cleaner is intended for household use only and NOT for commercial or industrial use.

- Only use the vacuum cleaner indoors on dry surfaces and keep the area you're cleaning well lit.
- Keep fingers, hair and loose clothing away from moving parts and openings whilst using the vacuum cleaner.
- Only Vax recommend tools and accessories should be used with this vacuum cleaner.



Don'ts

- Don't use this vacuum cleaner if it has been dropped, damaged or left outdoors or the filters not in their original place.
- Don't run over the power cord or use vacuum cleaner if the power cord or plug is damaged. Please contact our Customer Care Line on: 0330 026 8455 (Mon-Fri 8:30am to 6:30pm, Sat 9:00am to 5:00pm).
- Don't handle the plug or use the vacuum cleaner with wet hands.
- Don't pull or carry this vacuum cleaner by the power cord. Don't use the power cord as a handle, pull the power cord around corners, sharp edges or close a door over the power cord. Don't unplug vacuum cleaner by pulling on the power cord.
- Don't lift or carry the vacuum cleaner by the dirt container handle.



Do's

- Turn off all controls on the vacuum cleaner before disconnecting or connecting the power cord.
- Always make sure both the pre-motor/post-motor filters are in place before use.
- Always switch off the vacuum cleaner before disconnecting or connecting the hose and accessories.
- Keep all openings clear and free from debris as this may affect the airflow/suction.
- Always replace the fuse in the plug with a British 13amp fuse.
- Always protect the power cable from heated surfaces and open flames.

- This vacuum cleaner can be used by children aged from 8 years and above and persons with reduced physical, sensory or mental capabilities or lack of experience and knowledge if they have been given supervision or instruction concerning use of the vacuum cleaner in a safe way and understand the hazards involved. Children shall not play with the vacuum cleaner. Cleaning and user maintenance shall not be made by children without supervision.

- Don't vacuum up any flammable or combustible materials (lighter fluid, petrol, kerosene etc.) or use the vacuum cleaner in an area with explosive vapours or liquid.
- Don't vacuum up hot coals, cigarette butts, matches or smoking hot burning items or use in an area where there may be harmful fluids (chlorine, bleach, and ammonia drain cleaner).
- Don't attempt to remove blockages with sharp objects as this may cause damage to your vacuum cleaner.
- Don't vacuum up hard or sharp objects such as glass, nails, screws or coins etc.
- Don't use the vacuum cleaner with incorrect voltage as this may result in damage or injury to the user. The correct voltage is listed on the ratings label.

- Take extra care when positioning and using the vacuum cleaner on the stairs.
- Use only CE approved 13amp extension cords, non-approved extension cords may overheat. Care should be taken to arrange the extension cord as it can be a trip hazard.
- Store your vacuum cleaner in a cool, dry area. If filters have been cleaned as per user guide instructions ensure they are thoroughly dry before storing away.

PLEASE KEEP INSTRUCTIONS FOR FURTHER USE.

Thank you for buying this Mach Pet.

Taking care of your carpets and hard floors

The Mach Pet is designed to make vacuuming carpets and hard floors regularly, as effective and efficient as possible and this user guide will help you get the most out of your machine.

Maintaining your carpets and hard floors will ensure they keep their appearance for longer. You've chosen the carpets and hard floors for your home for a reason and Vax will help you take good care of them.

Taking care of your Mach Pet

Also inside this guide are instructions on maintaining your new machine, so that it's always ready when you are to tackle your carpets and hard floors.

Taking care of you

We're here if you need us. Instead of taking me back to the shop, simply visit:

vax.co.uk/support or call:

(UK) **0330 026 8455** (ROI) 1-800 928 308

Monday-Friday 8:30am to 6:30pm, Saturday 9:00am to 5:00pm

Calls are charged at the UK local rate. Please make a note of the serial number and model number of the product before calling.

Alternatively, you can write to us at:

Vax Ltd., Plot 302, Stonebridge Cross Business Park, Hampton Lovett, Droitwich, WR9 0LW, UK

This user guide can be found online at: vax.co.uk/support



You're home.™



Let us know what you think **@VaxUK**

Contents

Mach Pet

Let's talk safety

Getting to know your machine

Getting started

Using your machine

Taking care of your machine

Let's talk technical

Accessories

Notes

What to do if it goes wrong

Getting in touch

Included with your machine



Accessory hose and handle



Telescopic extension tube

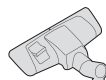

Combination floorhead



Dusting brush



Upholstery tool



Crevice tool



TurboTool



Tool connector



Hard floor tool

Initial Setup for normal operation

1. Use the base accessories.
 - Shortest hose.
 - Extension tube set to shortest practicable length.
2. Clean filters installed.
3. Dust receptacle empty.
4. All Bleeds must be closed.
5. Floor heads/tools set to Carpet Mode for carpet cleaning.
6. Mechanical Agitation turned ON for carpet cleaning.
7. Floor heads/tools set to Hard Floor Mode for hard floor cleaning.
8. Mechanical Agitation turned OFF for hard floor cleaning.

Getting to know your machine

Dirt container lid

Inner cyclone



Dirt container

Hose inlet

Bin release button

Cord rewind button

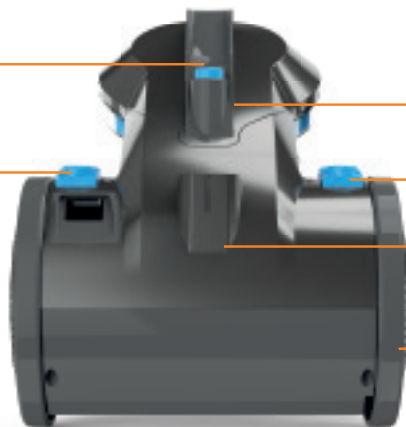

Carry handle

Power On/Off button

Floorhead parking slot

Inner wheel and
filter housing

Technical Specification

Name **Mach Pet**

Voltage **See rating label on machine for details**

Wattage **See rating label on machine for details**

Cord length **6m**

Weight **4.9kg**

Accessories & Consumables

Filter kit (Type 95)*

1-1-134231-00

2-in-1 tool (Type 2)*

1-1-132115-00

Upholstery tool (Type 6)*

1-9-132116-00

TurboTool (Type 6)*

1-1-134419-00

Hard floor tool (Type 3)*

1-1-135705-00

PLEASE READ 'LET'S TALK SAFETY' AT THE BEGINNING BEFORE USE

Before you begin cleaning

- Always switch off and unplug the vacuum cleaner before connecting or disconnecting the hose/attachments, or removing and emptying the dirt container.
- The vacuum cleaner is equipped with a thermal cut-out. If for any reason the vacuum cleaner does overheat the thermostat will automatically turn the vacuum cleaner off. If this happens, switch the vacuum cleaner off and unplug from electrical socket. Remove and empty the dirt container also check the vacuum cleaner for blockages. Allow the vacuum cleaner to cool for approximately 1 hour (if you have cleaned the filters please wait 24 hours for the filters to fully dry before putting back into the vacuum).
- Pre-motor filter requires cleaning at least every 3 months.
- If the vacuum cleaner is blocked, switch off and unplug before removing the blockage.
- When using the accessories always make sure the brushbar is switched to the off position.

IMPORTANT: The base of the vacuum cleaner should always be positioned flat on the floor when starting and in use. The dirt container should be locked into place before lifting the vacuum cleaner by the carry handle.

Assembling your machine

IMPORTANT: The condition of the filters affects the performance of your machine. Please check and clean filters periodically (depending on the level of use). For full cleaning instructions, see 'Taking care of your machine'.

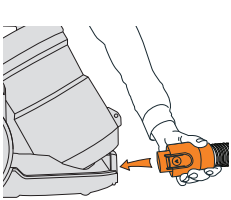

Insert the end of the hose into the unit. Ensure the hose has clicked into place.

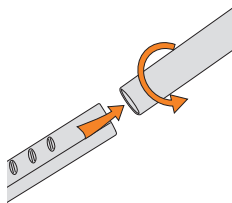

Insert handle into telescopic extension tube.

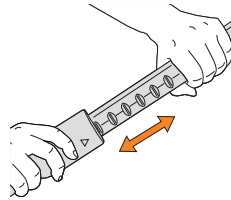

Press button on telescopic extension tube and adjust to required length.

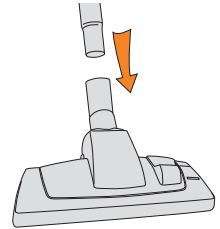

Insert the other end of the telescopic tube into the floorhead until it clicks into place.

Using your machine

How to use

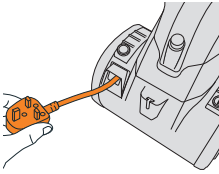

Fully unwind the power cord. A yellow mark on the cord indicates the recommended cord length. Do not exceed the cord beyond the yellow mark.

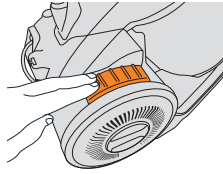

Plug in and switch the unit on by pressing the power button.

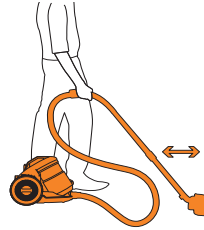

Use the vacuum by moving the floorhead backwards and forwards for an effective clean.

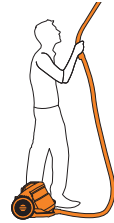

Remove the floorhead to use the hose in harder to reach places.

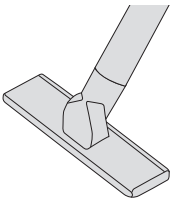

For the **most efficient** results on hard floors replace the combination floorhead with the specialist hard floor tool.

Using accessories

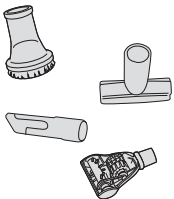

Choose an accessory and push onto the telescopic extension tube or hose.

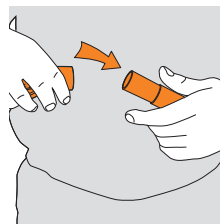

The tool connector must be fitted on the handle or extension tube when using the TurboTool (some models only).

Taking care of your machine

Emptying and cleaning the dirt container

IMPORTANT: Always switch off and unplug the vacuum cleaner from the electrical socket before assembling, opening or emptying the dirt container, or before connecting/disconnecting the attachments.

The motor is equipped with a thermal cut-out. If for any reason the unit should overheat, the thermostat will automatically turn the unit off.

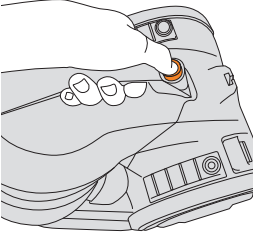

Press dirt container release button to remove the dirt container.

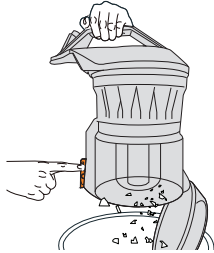

Hold dirt container over a bin and press dirt release button to open, allowing dirt to fall out.

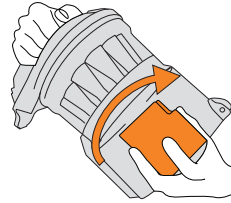

To remove the inner shroud, hold the container and rotate the shroud clockwise.

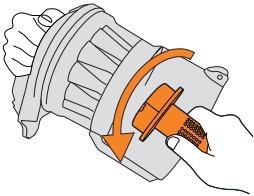

Hold the container and turn the inner separator anti-clockwise.



Dislodge any excess dirt by gently tapping the inner separator over the bin.

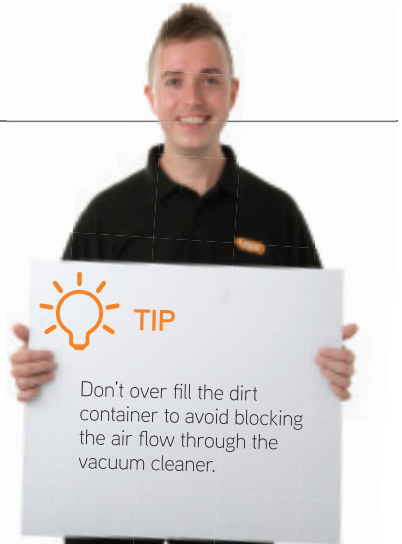

Don't over fill the dirt container to avoid blocking the air flow through the vacuum cleaner.

Taking care of your machine

Cleaning the pre-motor filter



Twist the dirt container lid anti-clockwise and lift to remove.

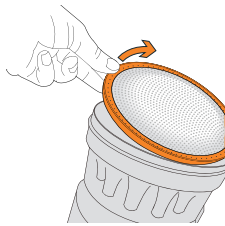

Lift out the pre-motor filter.

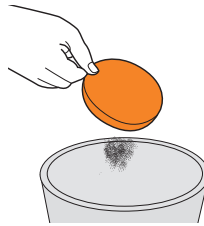

Tap the filter over a bin to remove any dirt and debris.



Rinse the filter under water (40°C Max). Leave to dry for 24 hours before placing back in the machine.

IMPORTANT: The exhaust filter is designed to offer long life with no maintenance. The filter should be checked periodically and when heavily discoloured it should be replaced. Please do not wash, scrub or brush the filter as this will damage the delicate filter media.

Post-motor filter maintenance

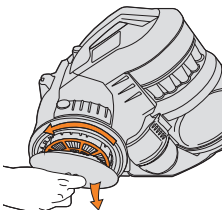

Post-motor filter is located in the right side wheel. Hold the centre of the wheel and twist wheel cover anti-clockwise.

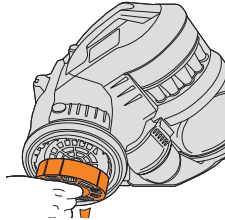

With the wheel cover off the post-motor filter is easily removed.



Check the post-motor filter for discoloration.



Storing your machine

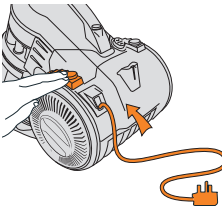

Cable rewind button is located at the rear of the machine. After unplugging press the cable rewind until the cord is fully retracted.

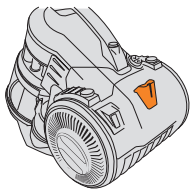

For convenience there is a parking slot located at the rear of the vacuum cleaner where the floorhead and tubes can be attached for storage and carrying.

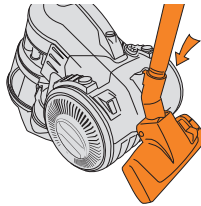

TIP
Clean the pre-motor filter every time the dirt container is emptied and replace the post-motor filter every 12 months.

IMPORTANT: Remove accessory from hose or telescopic extension tube before performing maintenance or trouble shooting checks.

Removing blockages from the TurboTool

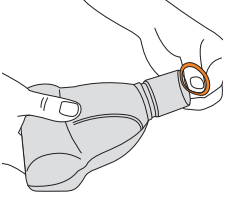

Slide the locking ring to remove.

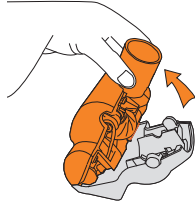

Lift and separate the housing.

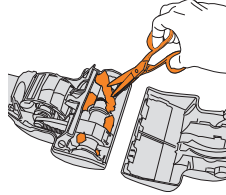

Using a pair of scissors, cut any hair or debris free from around the brushes.

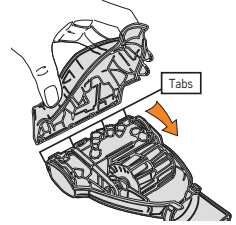

Line up the tabs on front of housing and push together to refit. Slide locking ring into groove to secure.

Removing blockages from the hose

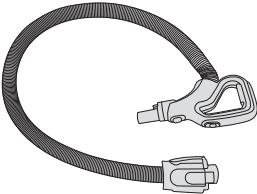

Remove the hose from the vacuum cleaner and telescopic extension tube. Remove any blockage by inserting a wire coat hanger into the hose.



TIP

To test for a blockage in the hose, drop a small ball of paper into the hose. The paper will drop through if the hose is clear.

Don't forget your accessories!

Order at: www.vax.co.uk/spares-and-solutions

Pro Cleaning Kit (Type 2)

1-1-133326-00

All our best tools all in one kit that makes cleaning your home quicker, easier and with even better results. We've taken care of cleaning all of the hard to reach areas such as on top of cupboards and in between blinds to the dust that collates behind and within the radiator.



TurboTool (Type 6)

1-1-134419-00

Use the TurboTool for vacuuming your stairs, upholstery and car interiors. It's great for picking up stubborn pet hair.





What to do if it goes wrong

Problem

There is an accessory missing

Solution

- Check the 'This pack contains' panel on the box to make sure the part is included with your machine.

Why does my vacuum cleaner have no power?

- The plug may not be fully pushed into the electrical socket.
- Check the fuse in the plug if this needs replacing, always replace with a British 13amp fuse.
- The motor thermostat may have tripped. If this has happened, unplug the vacuum cleaner. Remove and empty the dirt container and check the hose for blockages. Clean the filters and allow the vacuum cleaner to cool for approximately 1 hour (if you have washed the filters you will need to wait 24 hours for the filters to fully dry before putting them back into the vacuum cleaner).

Why won't the vacuum cleaner pick up?

- The dirt container may not be correctly fitted, remove the dirt container from the vacuum cleaner and check it's assembled correctly, refit ensuring it's locked into place.
- The filter may be clogged, clean the filter. Go to 'Taking care of your machine'.
- The dirt container may be blocked, empty the dirt container. Go to 'Taking care of your machine'.
- There may be a blockage in the hose/tube. Disconnect from the vacuum cleaner and carefully remove any blockages. Go to 'Let's talk technical'.

Why is dust escaping from the vacuum?

- The filters may be clogged, clean the filter. Go to 'Taking care of your machine'.

IMPORTANT: To reduce the risk of personal injury, unplug the vacuum before performing maintenance/troubleshooting checks.

It's quick and easy to
register for your **FREE**

**2 year
guarantee[†]**

Online at: **vax.co.uk/guarantees**

Please retain your original receipt for proof of purchase.

we're here if you need us

Online **vax.co.uk/support**

Call: (UK) **0330 026 8455** (ROI) 1-800 928 308

Monday-Friday 8:30am to 6:30pm, Saturday 9:00am to 5:00pm*

Alternatively, you can write to us at:

Vax Ltd, Plot 302, Stonebridge Cross Business Park, Hampton Lovett, Droitwich,
Worcestershire, WL9 0LW, UK

* Calls are charged at the UK local rate. Please make a note of the serial number and model number of the product before calling.

† Registration required. Terms and conditions apply, see vax.co.uk for details.



You're home.™



@VaxUK

Vax Ltd., 5th Floor 2 Colmore Square, 38 Colmore Circus, Queensway, Birmingham, B4 6BN, UK
email: info@vax.co.uk website: vax.co.uk



EEC Statement of Compliance: Manufacturer/EEC importer: Vax Limited, hereby on our own responsibility, declare that the C85-MQ-Pe is manufactured in compliance with the following Directives:

Safety: 2006/95/EC Low Voltage Directive. **EMC:** 2004/108/EC Electromagnetic Compatibility Directive.



Waste electrical products should not be disposed of with household waste. Please recycle where facilities exist. Check with your Local Authority or retailer for recycling advice.