

BUSH RETRO TALL LARDER

Installation & User Instructions - Please keep for future reference

BRTL60170B
BRTL60170R
BRTL60170C

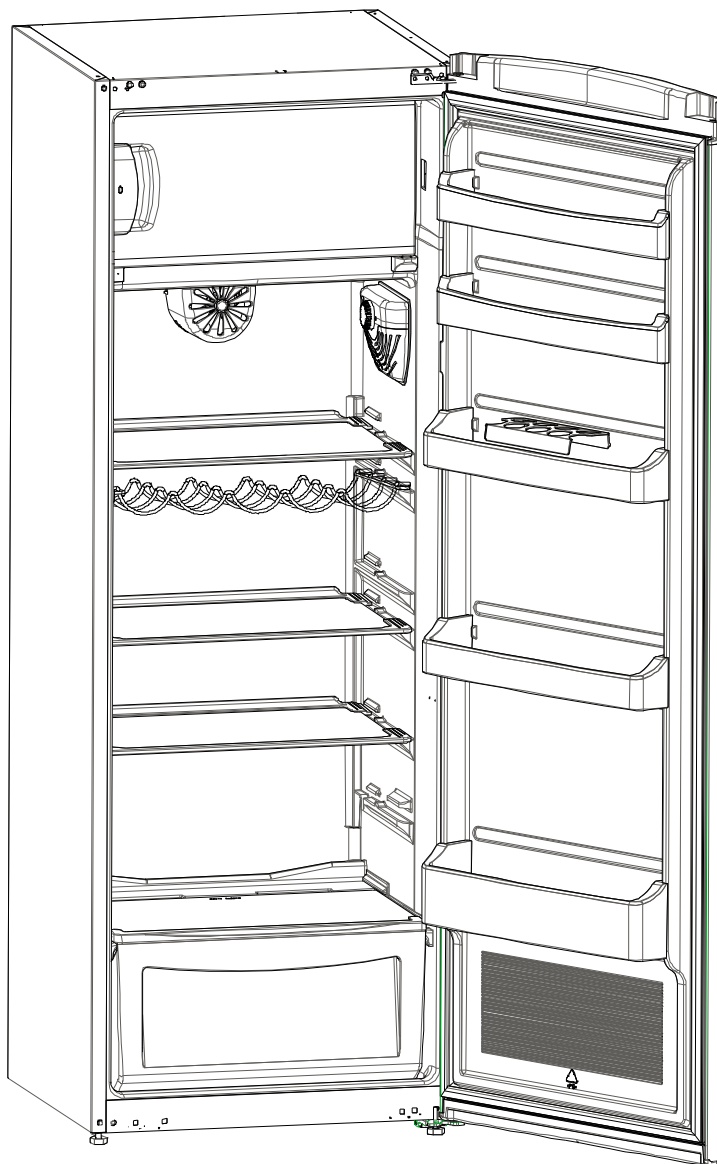

Important – Please read these instructions fully before installing or using

These instructions contain important information which will help you get the best from your appliance and ensure safe and correct installation, use and maintenance.

If you need help or have damaged or missing parts, call the **Customer Helpline: 0345 257 7271**

Contents

Customer Helpline: 0345 257 7271

Description Of Products & Content	3
General warnings	4
BEFORE USING THE APPLIANCE	4
Old and out-of-order fridges	5
Safety warnings	5
Installing and operating your fridge	6
Before Using your Fridge	6
FUNCTIONS AND CONTROLS	7
Thermostat settings	7
Super switch	7
Accessories	8
<i>“Door Open” Indicator</i>	<i>8</i>
ARRANGING FOOD IN THE APPLIANCE	9
Refrigerator compartment	9
Freezer compartment	9
CLEANING AND MAINTENANCE	10
Defrosting	10
SHIPMENT AND REPOSITIONING	11
Repositioning the Door	11
Trouble Shooting	11
Replacing the light bulb	11
BEFORE CALLING YOUR AFTER SALES	
SERVICE	12
Technical Specifications	13
Tips for saving energy	14

Product code

BRTL60170B
BRTL60170R
BRTL60170C

Description Of Products & Content

Customer Helpline: 0345 257 7271

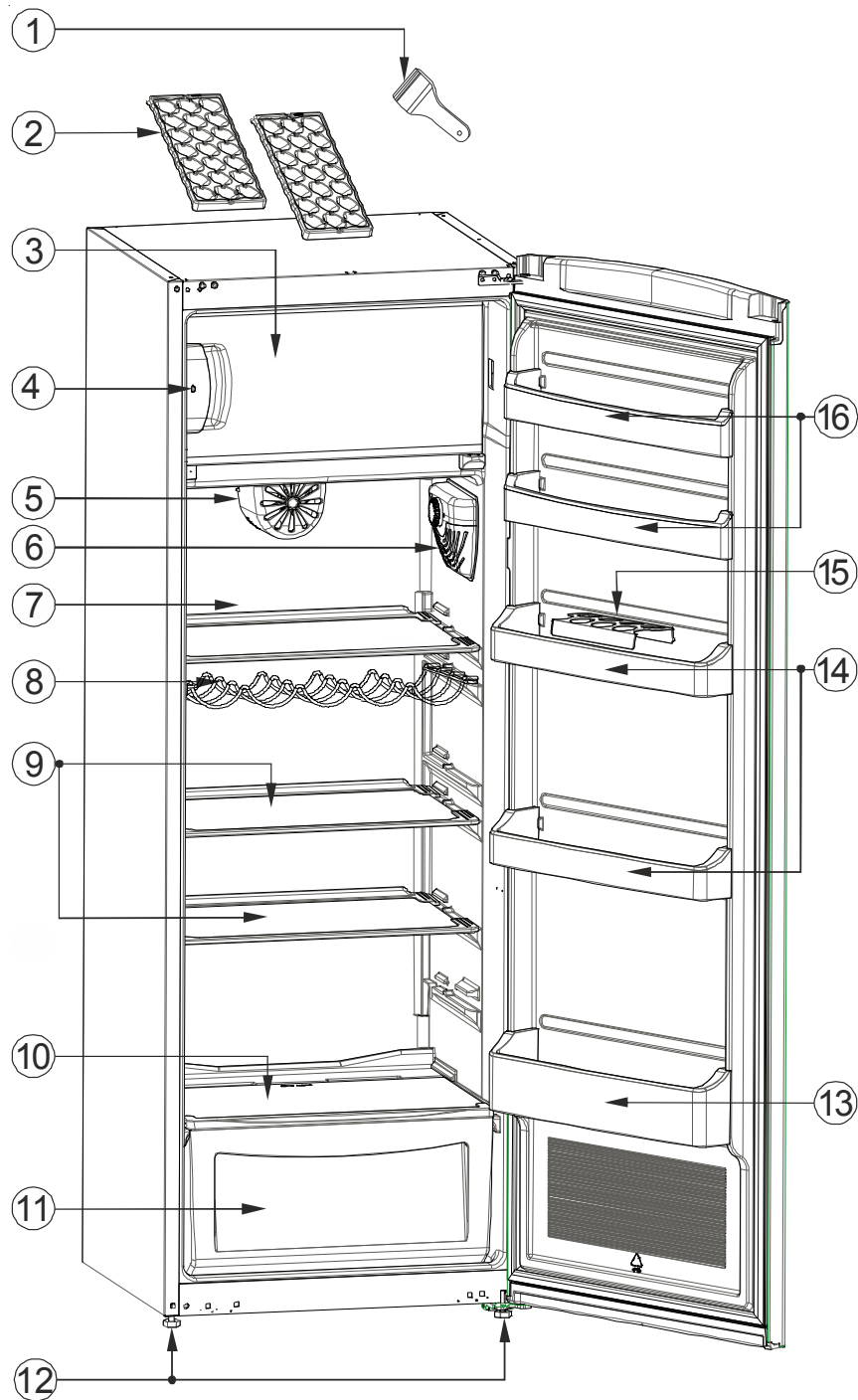

- 1) Plastic Scrapper x 1
- 2) Ice Tray x 2
- 3) Freezer Compartment
- 4) "Door Open" Indicator
- 5) Turbo (If available on your product*)
- 6) Thermostat Box
- 7) Fridge compartment
- 8) Wine Rack x 1

- 9) Refrigerator shelves
- 10) Vegetable holder cover
- 11) Vegetable holder
- 12) Leveling feet x 2
- 13) Bottle holder
- 14) Dairy holder
- 15) Egg Holders x 2
- 16) Upper door shelves



BEFORE USING THE APPLIANCE

Customer Helpline: 0345 257 7271

Important - Please read these instructions fully before installation

General warnings

WARNING: Keep ventilation openings, in the appliance enclosure or in the built-in structure, clear of obstruction.

WARNING: Do not use mechanical devices or other means to accelerate the defrosting process, other than those recommended by the manufacturer.

WARNING: Do not use electrical appliances inside the food storage compartments of the appliance, unless they are of the type recommended by the manufacturer.

WARNING: Do not damage the refrigerant circuit.

WARNING: To avoid a hazard due to the instability of the appliance, it must be fixed in accordance with the instructions.

- This appliance contains the coolant Isobutane (R600a), a natural gas which is environmentally friendly. Although it is flammable, it does not damage the ozone layer and does not increase the greenhouse effect. The use of this coolant has, however, led to a slight increase in the noise level of the appliance. In addition to the noise of the compressor, you might be able to hear the coolant flowing around the system. This is unavoidable, but does not have any adverse effect on the performance of the appliance. Care must be taken during the transportation and installation of the appliance that no parts of the cooling system are damaged. Leaking coolant can damage the eyes.

In the event of any damage:

- Avoid open flames and anything which creates a spark,
- Disconnect from the mains,

- Air the room in which the appliance is located for several minutes

- Contact the Service Department for advice.

- Whilst carrying and positioning the appliance care must be taken not to damage the cooler gas circuit at the rear of the appliance

- Do not store explosive substances such as aerosol cans with a flammable propellant in this appliance.

- This appliance is not designed for commercial use. It is intended for use in domestic households only.

- This appliance is not intended for outdoor use. It must only be used as a domestic appliance to cool and store food as well as to store deep frozen food, freeze fresh food and to prepare ice.

- **If the socket does not match the refrigerator plug, it must be replaced by the manufacturer, its service agent or similar qualified persons in order to prevent any hazard occurring.**

- This appliance is not intended for use by persons (including children) with reduced physical, sensory or mental capabilities, or lack of experience and knowledge, unless they have been given supervision or instruction concerning use of the appliance by a person responsible for their safety. Children should be supervised to ensure that they do not play with the appliance.

- Before connecting the appliance, make sure that the connection data on the data plate (voltage and frequency) matches the mains electricity supply. This data must correspond in order to avoid the risk of damage to the appliance. Consult a qualified electrician if in any doubt.

Before using the appliance

Customer Helpline: 0345 257 7271

- Children 8 years and older may use the appliance only if they have been given clear instructions how to use it in a safe way manner and understand the hazards involved. Do not allow children to play with the packaging material, e.g. plastic bags and wrappings. Danger of suffocation.

- If the supply cord is damaged, it must be replaced by the manufacturer, its service agent or similar qualified persons in order to avoid a hazard.

Old and out-of-order fridges

- If your old fridge has a locking mechanism please ensure it is unusable before discarding it, as children may get trapped inside and it may cause an accident or injury.

- Old fridges and freezers contain isolation material and refrigerant with CFC. Therefore, take care not to harm the environment when you are discarding your old fridges.

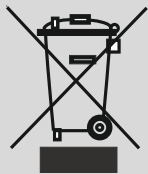

Please ask your local authority about the disposal of the WEEE products reuse, recycle and recovery purposes.

Notes:

- Please read the instruction manual carefully before installing and using your appliance. **We are not responsible of the damage occurred due to misuse.**
- Follow all instructions on your appliance and instruction manual, keep this manual in a safe place to resolve any problems that may occur in the future.
- This appliance is produced to be used in domestic households only. It is not suitable for commercial use. Such use will cause the guarantee of the appliance to be cancelled and our company will not be responsible for the losses that may occur.
- This appliance is produced to be used in domestic households and it is only suitable for cooling / storing foods. It is not suitable for commercial use and/or for storing substances except for food. Our company is not responsible for the losses that may occur by incorrect use.

Safety warnings

- Do not use extension leads when connecting this appliance.
- Do not plug in damaged, torn or old plugs.
- Do not pull, bend or damage the cord.



- This appliance is designed for use by adults, do not allow children to play with the appliance or let them to hang on the door.



- Do not insert or remove the plug from the socket with wet hands. Electrocutation and or injury may occur.

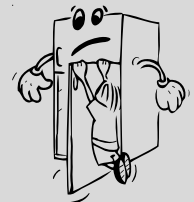

- Do not place glass bottles or cans in the freezer compartment. Bottles or cans may explode.

- Do not place explosive or flammable material in your fridge for your safety. Place drinks with higher alcohol content vertically and by closing their necks tightly in the fridge compartment.

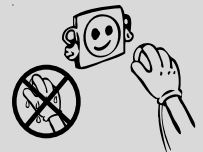

- When taking ice made in the freezer compartment, do not touch it, ice may cause ice burns and/or cuts.



- Do not touch frozen goods with wet hands! Do not eat ice-cream and ice cubes immediately after you take them out of the freezer compartment!
- Do not re-freeze defrosted items. This may cause health issues like food poisoning.
- Do not cover the body or top of fridge. This affects the performance of your fridge.
- Ensure the accessories are secured during transportation to prevent damage.



Installing and operating your fridge

Before starting to use your fridge, you should pay attention to the following points:

- Operating voltage for your fridge is 220-240 V at 50Hz.
- We do not take the responsibility of the damages that occur due to ungrounded usage.
- Do not place your appliance in direct sunlight.
- Your appliance should be at least 50 cm away from stoves, Gas ovens and heaters, and should be at least 5 cm away from electrical ovens.
- Your fridge should never be used outdoors or left out in the rain.
- When your fridge is placed next to a deep freezer, there should be at least 2 cm between them to prevent humidity on the outer surface.
- Do not place anything on your fridge, and install your fridge in a suitable place so that there is at least 15cm clearance at the top.
- The adjustable front legs should stabilise in an appropriate height to allow your fridge to operate in a stable and proper way. You can adjust the legs by turning them clockwise (or in the opposite direction). This should be done before placing food in the fridge.



- Before using your fridge, wipe all parts with warm water, and then rinse and dry. Place all parts back in the appliance after cleaning.
- Install the distance adjustment plastic (the part with black vanes at the rear) by turning it 90° as shown in the figure to prevent the condenser from touching the wall.
- Refrigerators should be placed against a wall with a free distance of at least 75mm.

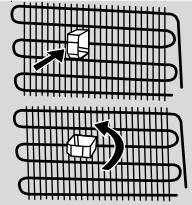

Before Using your Fridge

- Before switching on your appliance for the first time, ensure it is positioned in its desired final location and is in its upright position for at least 3 hours before plugging in and switching on the power. Otherwise you may damage the compressor.
- You may experience a odour from the appliance when it is operated for the first time. This is normal and will fade when your appliance starts to cool.

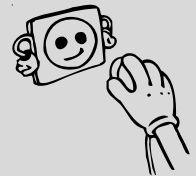

Thermostat settings

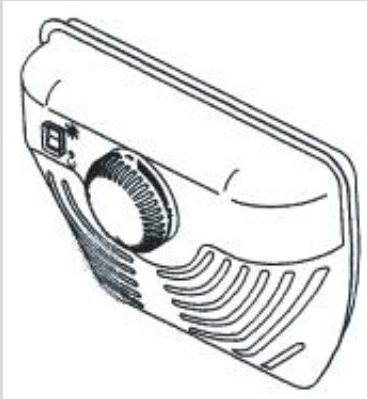

- The thermostat automatically regulates the inside temperature of the refrigerator compartment and freezer compartment. By rotating the control knob from position 1 to 5, colder temperatures can be obtained. « • » position shows the thermostat is closed and no cooling will be available.
- For short-term storage of food in the freezer compartment, you can set the knob between 1 and 3 position.
- For long-term storage of food in the freezer compartment, you can set the control knob between the 3-4 position.

The ambient temperature, of the freshly stored food and how often the door is opened, affects the temperature in the refrigerator compartment. If required, change the temperature setting.

Super switch

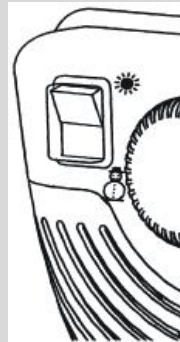

- Normally set this switch to '★' position. Except when the ambient temperature is low like in winter. (ie. below 16°C) or when the freezer temperature needs to be maintained lower. In such circumstances, turn the switch position 'ⓘ'

- When the freezer compartment is cooled down to a sufficient temperature, or the weather gets hot, turn the super switch off to save electrical consumption.
- When you first switch on your appliance the compressor will work continuously for approximately 24 hours. This is normal until it reaches a sufficient cooling temperature.
- During the first 24 hours of switching the appliance on, limit the number of times you open the door and do not place too much food in the appliance.

If the unit is switched off, you must allow at least 5 minutes before switching back on in order not to damage the compressor.

Accessories

“Door Open” Indicator

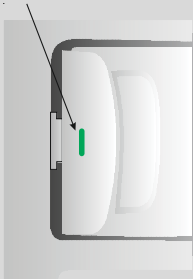

- The « Door Open » indicator on the handle shows whether the door has closed properly or whether it is still open.
- If the indicator is red, the door is still open.
- If the indicator is white, the door is properly closed.
- The freezer’s door should always be kept closed. This will prevent food products from defrosting, it will avoid heavy ice and frost build-up inside the freezer and an unnecessary increase in energy consumption.

Ice tray

- Fill the ice tray with water and place in freezer compartment.
- After the water has completely frozen , you can twist the tray as shown below to get the ice cubes.

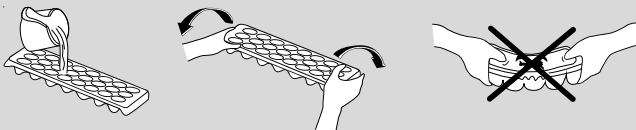

Plastic scraper

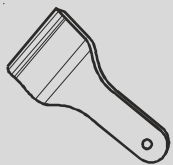

After a period of time, frost will build up in certain areas in the freezer compartment. The frost, accumulated in the freezer, should be removed periodically.

Use the plastic scraper provided if necessary. Do not use sharp metal objects for this operation. They could puncture the refrigerator circuit and cause damage to the unit.

- Do not block the air inlet and outlet openings when storing food as this will restrict circulation and reduce the appliance efficiency.

ARRANGING FOOD IN THE APPLIANCE

Customer Helpline: 0345 257 7271

Refrigerator compartment

- To reduce humidity and consequent increase of frost, never place liquids in unsealed containers in the refrigerator. Frost tends to concentrate in the coldest parts of the evaporator and in time will require more frequent defrosting.
- Never place warm food in the refrigerator. Warm food should be allowed to cool at room temperature and should be arranged to ensure adequate air circulation in the refrigerator compartment.
- Nothing should touch the back wall as it will cause frost and the packages can stick on the back wall. Do not open the refrigerator door too frequently.
- Arrange the meat and cleaned fish (wrapped in packages or sheets of plastic) which you will use in 1-2 days, in the bottom section of the refrigerator compartment (that is above the vegetable holder) as this is the coldest section and will ensure the best storing conditions.
- You can place fruit and vegetables unwrapped in the vegetable holder.

Freezer compartment

- When freezing fresh food ensure it is wrapped securely
- Once the unit has been defrosted replace the foods into freezer and remember to consume them in as short period of time as possible.
- Never place warm food in the freezer compartment.
- For storing frozen foods; the instructions shown on frozen food packages should always be followed carefully and if no information is provided food should not be stored for more than 3 months from the purchased date.
- When buying frozen foods ensure that these have been frozen at suitable temperatures and that the packing is intact.

- Frozen foods should be transported in appropriate containers to maintain the quality of the food and should be returned to the freezer compartment in the shortest possible time.
- The storage life of frozen foods depends on the room temperature, thermostat setting, how often the door is opened, the type of food and the length of time required to transport the product from the shop to your home. Always follow the instructions printed on the package and never exceed the maximum storage life indicated.

CLEANING AND MAINTENANCE

Customer Helpline: 0345 257 7271

- Make sure you unplug the fridge before starting to clean it.

- Do not pour water directly over your appliance.

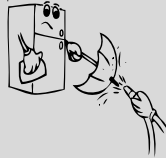

- You can wipe the inner and outer sides with a soft cloth or a sponge using warm soapy water.

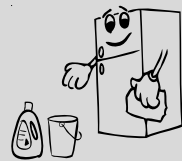

- Remove parts individually and clean by hand with soapy water. Do not place in dishwashers.

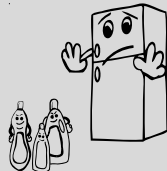
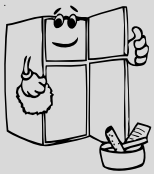

- Never use flammable, explosive or corrosive material for cleaning your appliance

- You should clean the condenser periodically to keep your appliance running efficiently.

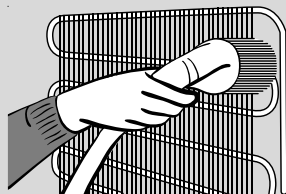

Make sure your appliance is unplugged before cleaning.

Defrosting

Refrigerator compartment;

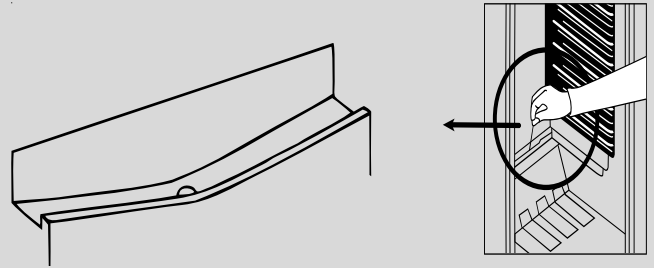

- Defrosting occurs automatically in the refrigerator compartment during operation ; the defrosted water is collected by the evaporating tray and evaporates automatically.
- The evaporating tray and the defrost water drain hole should be cleaned periodically .

Freezer compartment;

The frost, accumulated in the freezer compartment, should be removed periodically. (Use the plastic scraper provided) The freezer compartment should be defrosted and cleaned at least twice a year.

For this;

- During defrosting, frozen foods should be wrapped in several layers of paper and kept in a cool place. The inevitable rise in temperature will shorten their storage life. Remember to use these foods within a relatively short period of time.
- Set the thermostat control knob to position “.” or unplug the unit; leave the door open until completely defrosted.
- To accelerate the defrosting process one or more basins of warm water can be placed inside the freezer compartment.
- Once defrosted and cleaned, ensure the compartment is completely dry before switching back on and setting the thermostat control knob to desired temperature.

Replacing the light bulb

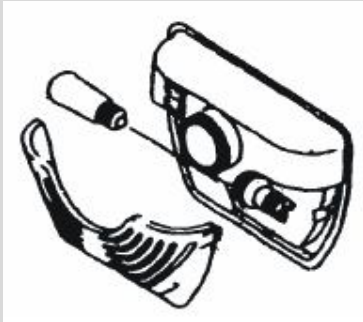

To replace the bulb in the freezer and fridge compartments:

- 1- Unplug your fridge.
- 2- Carefully remove the light cover from the top panel.
- 3- Replace with the same wattage bulb.
- 4- Reinstall the light cover.
- 5- Wait 5 minutes before re-plugging the fridge in and restore the thermostat to its original position.

SHIPMENT AND REPOSITIONING

- Original package and foam may be kept for re-transportation (optionally).
- You should fasten your fridge with thick package, bands or strong cords and follow the instructions for transportation on the package for re-transportation.
- Remove movable parts (shelves, accessories, vegetable bins etc.) or fix them into the fridge so they are secure and do not move.
- Carry your fridge in the upright position only.

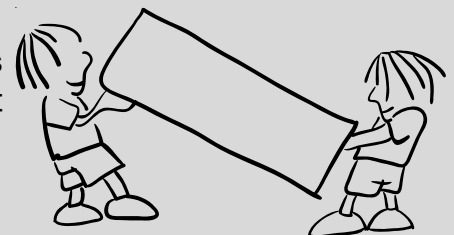

Repositioning the Door

IT IS NOT POSSIBLE ON THIS MODEL TO CHANGE THE OPENING DIRECTION OF YOUR APPLIANCES DOORS

BEFORE CALLING YOUR AFTER SALES SERVICE

Customer Helpline: 0345 257 7271

If your appliance is not working correctly, before calling the service helpline check the following:

What to do if your refrigerator does not operate ;

Check that ;

- Is there power to the appliance?
- Check your fuse box to see if it has tripped out.
- The thermostat setting is on « • » position ,
- Check the power socket is working by plugging in another appliance.

What to do if your refrigerator performs poorly ;

Check that ;

- You have not overloaded the appliance ,
- The doors are closed correctly ,
- There is no dust on the condenser ,
- There is enough clearance around the appliance.

If there is noise ;

The cooling gas which circulates in the refrigerator circuit may make a slight noise(bubbling sound) even when the compressor is not running. Do not worry this is quite normal. If these sounds are different check that ;

- The appliance is level
- Is there anything behind your appliance?
- Are the shelves or the plates on the shelves of your appliance vibrating? If so rearrange the shelves accordingly.

If there is water in the lower part of the refrigerator ;

Check that ;

The drain hole for defrost water is not clogged(Use defrost drain plug to clean the drain hole)

If your fridge is not cooling enough;

Your fridge is designed to operate in the ambient temperature intervals stated in the standards, according to the climate class stated in the information label. We do not recommend operating your fridge outside of stated temperatures value limits in terms of cooling effectiveness.

Climate Class	Ambient Temperature (°C)
T	Between 16 and 43 (°C)
ST	Between 16 and 38 (°C)
N	Between 16 and 32 (°C)
SN	Between 10 and 32 (°C)

Recommendations

- In order to increase space and improve the efficiency, the « cooling section » of this appliance is positioned inside the back wall of the refrigerator compartment. When the appliance is running, this wall is covered with frost or water drops. Do not worry. This is quite normal. The appliance should be defrosted only if an excessively thick layer forms on the wall.
- If the appliance is not used for a long time (for example during the summer holidays)Defrost and clean the refrigerator leaving the door open to odours developing

Supplier's name or trade mark	BUSH
Model / Item	BRTL60170B BRTL60170R BRTL60170C
Type of appliance	GT/SN340
The energy efficiency class	A+
Voltage	220-240V / 50 Hz
Power	146 W
Energy consumption	0,718 kw/24h - 262 kw/year
Net storage volume of fresh food	281 lt.
Net storage volume of frozen food	30 lt.
Star rating of frozen food storage compartment	4
Power cut failure safe storage	720 mins (-18°C to -9°C)
Freezing capacity'	2 Kg
Climate class'	T/SN (10°C - 43°C)
Size (mm) (W x D x H)	595 x 598 x 1720
Noise'	43 dB (A)

We apologise for any inconvenience caused by minor change or inconsistencies in these instructions that may occur as a result of product improvements and development.

Conformity Information

- This equipment is designed for use at an ambient temperature within the 10°C - 43°C range
- The appliance is designed in compliance with the IEC60335-1 / IEC60335-2-24, 2004/108/EC standards.

- 1– Install the appliance in a cool, well ventilated room , but not in direct sunlight or near heat sources (radiators, cooker, etc....).
- 2– Allow warm food and drinks to cool down before placing in the appliance.
- 3– When thawing frozen food, place it in the refrigerator compartment. The frozen food will help to cool the refrigerator compartment when it is thawing.
- 4– When placing liquids in the appliance they must be covered.
- 5– When placing food and drinks, open the appliance door as briefly as possible.
- 6– Keep closed the covers of any different temperature compartments in the appliance (crisper, chiller ...etc).
- 7– Door seals should be kept clean and undamaged.

Guarantee



Product Guarantee

This product is guaranteed against manufacturing defects for a period of



This product is guaranteed for twenty four months from the date of original purchase. Any defect that arises due to faulty materials or workmanship will either be replaced, refunded or repaired free of charge where possible during this period by the dealer from whom you purchased the unit.

The guarantee is subject to the following provisions:

- The guarantee does not cover accidental damage, misuse, cabinet parts, knobs or consumable items.
- The product must be correctly installed and operated in accordance with the instructions contained in this manual.
- It must be used solely for domestic purpose.
- The guarantee will be rendered invalid if the product is re-sold or has been damaged by inexpert repair.
- Specifications are subject to change without notice.
- The manufacturer disclaims any liability for the incidental or consequential damages.
- The guarantee is in addition to, and does not diminish your statutory or legal rights.
- In the event of a problem with the product with in the guarantee period call the Customer Helpline: **0845 600 4632**.

Guarantor: Argos Ltd
489 - 499 Avebury Boulevard
Central Milton Keynes
MK9 2NW

RE-WIRING YOUR PLUG

For your safety please read the following information

Warning: This appliance must be earthed.

This appliance operates from 220-240 volts and should be protected by a 13 amp fuse in the plug.

The appliance is supplied with a standard 13 amp 3-pin mains plug fitted with a 13-amp fuse. Should the fuse require replacement, it must be replaced with a fuse rated at 13 amp and approved to BS1362.

If the mains plug which is fitted is unsuitable for the socket outlet in your home or is removed for any other reason, please follow the instructions below on how to wire a 13 amp 3 pin plug..

How to wire a 13 amp plug.

Important

The wires in the mains lead on this appliance are coloured in accordance with the following code:

Green and Yellow - Earth

Blue – Neutral

Brown – Live

As the colours may not correspond with the markings identifying the terminals in your plug proceed as follows.

The green and yellow wire must be connected to the terminal in the plug which is marked with the letter E or with the earth symbol \equiv or coloured green and yellow.

The blue wire must be connected to the terminal marked N.

The brown wire must be connected to the terminal marked L.

You must make sure the lead is firmly secured under the cord clamp.

