



EN

English, 1

MWH 424.1 X

Contents

Electrical Connection, 4

Installation, 5-7

Installation

Placement

Building in

Install the grill pan

Turntable Installation

Setting up your oven, 8

Overall view

Names of Oven Parts and Accessories

Control Panel and Features

Start-up and use, 9-14

Operation instruction

Important safety instructions, 15-17

Utensils, 18

Utensil Test

Materials you can use in microwave oven

Materials to be avoided in microwave oven

Maintenance and care, 19

Cleaning

Troubleshooting, 20

Assistance, 21

Guarantee, 22

After Sales Service, 23

EN

Electrical Connection

DANGER

Electric Shock Hazard Touching some of the internal components can cause serious personal injury or death. Do not disassemble this appliance.

WARNING

The electrical connections must be made before installing the appliance in its housing. Electrical safety must be guaranteed by correct installation in the housing. During installation and maintenance operations, the appliance must be disconnected from the mains circuit-breaker or the fuses must be removed.

The appliance must be connected using a power cable equipped with 3 1.5mm² conductors (live + neutral + Earth), H05RR-F 300V/500V specification, connected to a single phase 230-240V~network in accordance with installation requirements. The safety wire (green-yellow) is connected to the appliance's Earth terminal and must be connected to the installation Earth.

If the appliance has an electrical connection, it must remain accessible after the appliance has been built in.

The oven's neutral (blue wire) must be connected to the network's neutral.

It must be possible to disconnect the appliance from the power supply, by fitting a switch on the fixed wiring system in accordance with installation rules.

Ensure that:

- The electrical power has sufficient voltage.
- the power cable is in good condition
- the diameter of the wires complies with installation requirements.
- your electrical installation is equipped with protection of at least 16 amps.

CAUTION

Personal Injury Hazard

It is hazardous for anyone other than a competent person to carry out any service or repair operation that involves the removal of a cover which gives protection against exposure to microwave energy.

- Please observe the installation instructions provided and note that this appliance should only be installed by an approved qualified installer.
- In case a new connection is needed, installation and cable connection must only be done by an approved qualified installer. If the connection is no longer accessible following installation, a double-pole disconnecting device must be present on the installation site with a contact gap of at least 3 mm.
- Adaptors, multiway strips and extension cables must not be used. Overloading can result in fire.

Disposal - Also see Page 23

When disposing of packaging material: observe local legislation so that the packaging may be reused.

The European Directive 2012/19/EEC on Waste Electrical and Electronic Equipment (WEEE), requires that old household electrical appliances must not be

- disposed of in the normal unsorted municipal waste stream. Old appliances must be collected separately
 - in order to optimise the recovery and recycling of the materials they contain and reduce the impact on human health and the environment. The crossed out "wheeled bin" symbol on the product reminds you of your obligation, that when you dispose of the appliance it must be separately collected.
- Consumers may take their old appliance to public waste collection areas, other communal collection areas, or if national legislation allows return it to a retailer when purchasing a similar new product. All major household appliance manufacturers are active in the creation of systems to manage the collection and disposal of old appliances.

Building in

- Do not hold or carry the appliance by the door handle. The door handle cannot hold the weight of the appliance and may break off.
- Carefully push the microwave into the box, making sure that it is in the centre.
 - Open the door and fasten the microwave with the screws that were supplied.

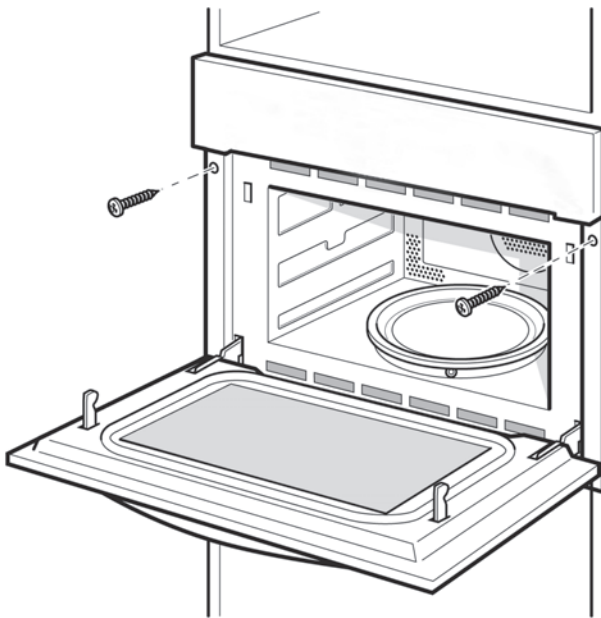

- Fully insert the appliance and centre it.
- Do not kink the connecting cable.
- Screw the appliance into place.
- The gap between the worktop and the appliance must not be closed by additional battens.

Install the grill pan

- Be sure the angle of the shaft.

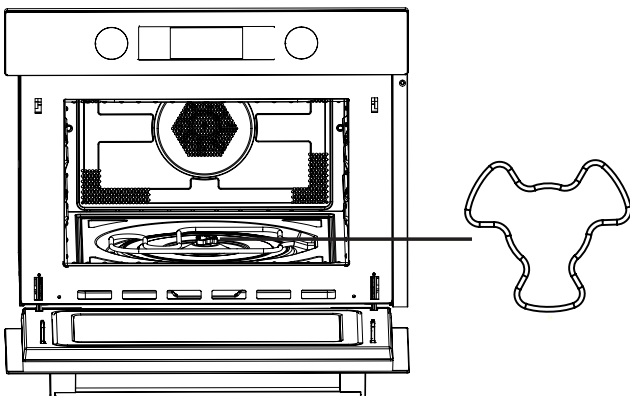

- Adjust the angle of the grill pan and the shaft.

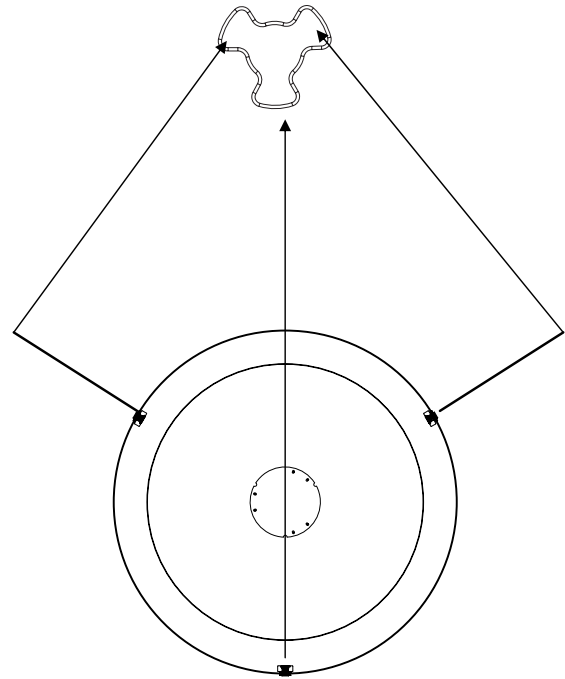

- Put the pan into the cavity and adjust slightly.

Specifications

Model:	MWH 424.1 X
Rated Voltage:	240V~50Hz
Rated Input Power (Microwave):	1650W
Rated Output Power (Microwave):	900W
Rated Input Power (Grill):	1750W
Rated Input Power (Convection):	1750W
Max Power:	3350W
Oven Capacity:	44L
Turntable Diameter:	ø 360mm
External Dimensions:	594x454.5x568mm
Net Weight:	Approx. 41 kg
	<p>According to Waste of Electrical and Electronic Equipment (WEEE) directive, WEEE should be separately collected and treated. If at any time in future you need to dispose of this product please do NOT dispose of this product with household</p>

Turntable Installation

- a) Never place the enamel tray upside down. The enamel tray should never be restricted.
- b) The enamel tray must always be used during cooking.
- c) All food and containers of food are always placed on the enamel tray for cooking.
- d) If enamel tray cracks or breaks, contact your nearest authorized service center.

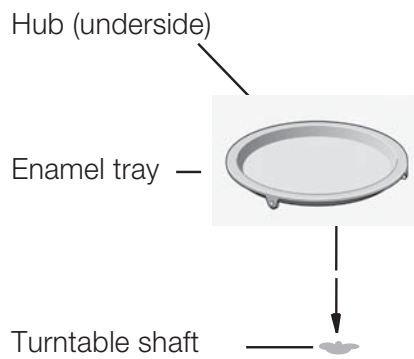

Setting up your oven

Overall view

Names of Oven Parts and Accessories

Remove the oven and all materials from the carton and oven cavity. Your oven comes with the following accessories:

Enamel Tray	1
Turntable ring assembly	1
Instruction Manual	1

1. Control panel
2. Grill element
3. Light
4. Level
5. Door glass
6. Hinge
7. Turntable shaft
8. Short Grill Rack
9. Long Grill Rack
10. Grill Pan

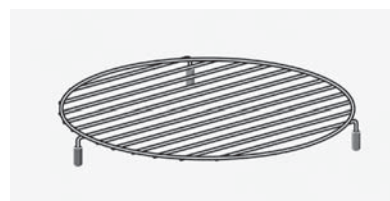
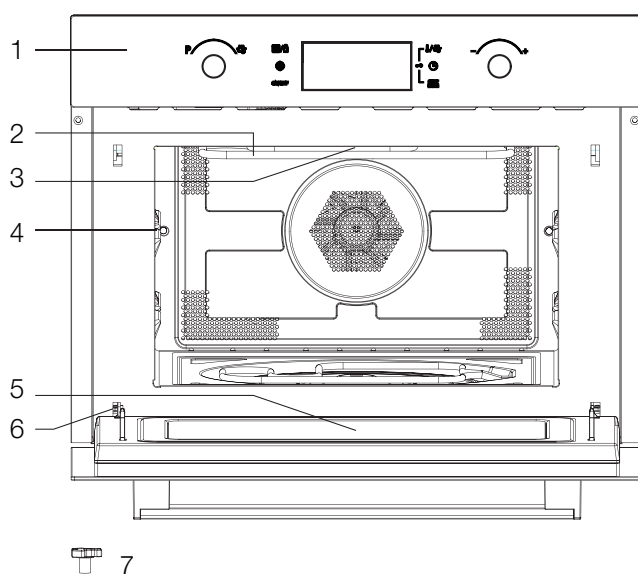

8



9



10

Control Panel and Features

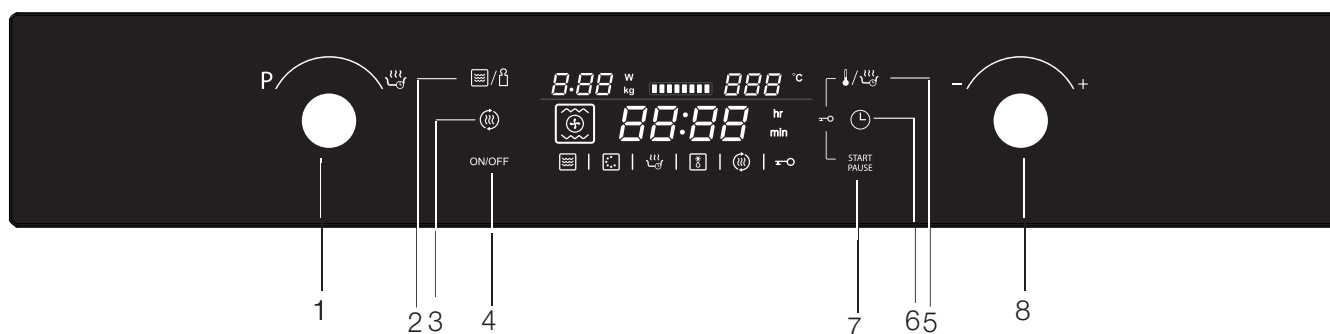

- | | |
|------------------------------|--------------------------------|
| 1) Function knob | 5) Temperature/automenu button |
| 2) Power/Weight button | 6) Clock button |
| 3) Quickly preheating button | 7) Start/Pause button |
| 4) On/Off Button | 8) Selection knob |

Start-up and use



EN

Operation instruction





This microwave oven uses modern electronic control to adjust cooking parameters to meet your needs better for cooking.

1. Clock Setting





When the microwave oven is electrified, "00:00" will blink, buzzer will ring once.

- 1) Turn  knob to set the right time (between 00:00 and 23:59.)
- 2) After you have set the right time, press "". The clock has been set.

Note:

- 1) If you want to change the time, you have to press and hold the "" button for 3 seconds. The actual time disappears and then the time will blink in the display.
Turn  knob to set the new time and press the "" button to confirm the setting.
- 2) If you do not want to see the clock in the display, press "" button briefly. The time disappears. Press "" again, and the clock appears in the display again.

2. Microwave Cooking

- 1) Press the "ON/OFF" button to activate the microwave function. "01:00" is blinking in the display and the microwave icon appears. If no operation in 10 seconds, the current power will be confirmed automatically.
- 2) Turn  knob to set the cooking time. The max. cooking time depends on the power that has been set. When the power is 900W, the MAX. time is 30 minutes and other powers are 90 minutes.
- 3) Press " / 
 button to adjust the microwave power.
- 4) Turn  knob to set the microwave power. (between 100W to 900W).
- 5) Press "START  " button to start cooking.

Note:

the step quantities for the adjustment time of the coding switch are as follow:

0---1 min	1 second
1---5 min	10 seconds
5---15 min	30 seconds
15---60 min	1 minute
60 min	5 minutes







Microwave Power Chart











Display	900W	700W	450W	300W	100W
---------	------	------	------	------	------

You can see from the table below from which power levels you can choose and for which foods the power levels are suitable.

Power level	Food
900 W	- Boiling water, reheating - Cooking chicken, fish, vegetables
700 W	- Reheating - Cooking mushrooms, shell fish - Cooking dishes containing eggs and cheese
450 W	- Cooking rice, soup
300 W	- Defrosting - Melting chocolate and butter
100 W	- Defrosting sensitive/delicate foods - Defrosting irregularly-shaped foods - Softening ice cream - Allowing dough to rise

Functions







Function		Mode		
	Microwave		Microwave	Microwave Use the microwave function to cook and reheat vegetables, potatoes, rice, fish and meat.
	Heating		Hot air	Hot air With hot air you can prepare meals in the same way as you do with a conventional oven. The microwave is not activated. You are advised to preheat the oven before putting the meal in the oven.
			Grill with fan	Grill with fan Use this function to roast meals evenly and at the same time give the meal a brown crust.
			Grill	Grill The grill is very suitable to prepare thin pieces of meat and fish.

Function		Mode		
	Heating		Hot air+ Bottom heat	Use this function to roast big pieces of meat, pizza, etc.
 + 	Combination		Hot air	Microwave + Hot air Use this function to roast meals quickly.
			Grill with fan	Microwave + Grill with fan
			Grill	Microwave + Grill Use this function to cook meals quickly and at the same time give the meal a brown crust (also au gratin). The microwave and the grill are activated at the same time. The microwave is cooking and the grill is roasting.
			Hot air+ Bottom heat	Microwave + Hot air + Bottom heat Use this function to roast big pieces of meat, pizza, etc.
	Auto-programs		P01 - P13	Automatic cooking programs
	Defrost			Defrost







Start-up and use

EN







3. Grill Cooking

- 1) Press the **"ON/OFF"** button to activate the microwave function.
- 2) Turn  knob to set the cooking mode.  indicator lights. The default grill power is the third level.  indicator will light when grill function is selected.
- 3) Press  to enter to the grill level.
- 4) Turn  to select the level 3(the MAX.), level 2 or level 1(the MIN.).
Press  to select the time setting mode. The default time is 10 minutes.
- 5) Turn  to select the cooking time of grill. The MAX time is 90 minutes.
- 6) Press **START** **"PAUSE"** button to start cooking.



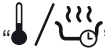

4. Convection Cooking

- 1) Press the **"ON/OFF"** button to activate the microwave function.
- 2) Turn  knob to set the convection mode.  indicator lights.  lights. The default temperature is 180 degrees.
- 3) Press  to enter to the temperature mode.
- 4) Turn  to select temperature. The temperature is from 50 to 230 degrees.
Press  to select the time setting mode. The default time is 10 minutes.
- 5) Turn  to select the cooking time. The MAX time is 5 hours.
- 6) Press **START** **"PAUSE"** button to start cooking.

5. Grill Fan Cooking

- 1) Press the **"ON/OFF"** button to activate the microwave function.
- 2) Turn  to select grill fan mode.  indicator lights. If no operation in 10 seconds, the current temp will be confirmed automatically. The default temperature is 180 degrees.  indicator will light when grill fan function is selected.
- 3) Press  to enter to the temperature selection.
- 4) Turn  to select the temperature between 100 to 230 degrees. The temperature are 100,105,110,115,120,125,130,135,140,145,150,155,160,165,170,175,180,185,190,195,200,205,210,215,220,225,230.
Press  to select the time setting mode. The default time is 10 minutes.
- 5) Turn  to select the cooking time. The MAX time is 5 hours.
- 6) Press **START** **"PAUSE"** button to start cooking.

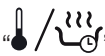
6. Convection + Bottom heat Cooking





- 1) Press the **"ON/OFF"** button to activate the microwave function.
- 2) Turn  to select bottom+convection mode.  indicator lights. If no operation in 10 seconds, the current temp will be confirmed automatically. The default temperature is 180 degrees.  indicator will light when convection + bottom function is selected.
- 3) Press  to enter to the temperature selection.
- 4) Turn  to select the temperature between 100 to 230 degrees. The temperature are 100,105,110,115,120,125,130,135,140,145,150,155,160,165,170,175,180,185,190,195,200,205,210,215,220,225,230.
Press  to select the time setting mode. The default time is 10 minutes.

5) Turn  to select the cooking time. The MAX time is 5 hours.

6) Press **START** "PAUSE" button to start cooking.

7. Microwave + Grill Cooking

1) Press the **"ON/OFF"** button to activate the microwave function.

2) Turn  to select the combination mode.  and  will light. The default power is level 3.  indicator will light when grill function is selected.

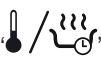
3) Press  to enter to the temperature selection.

4) Turn  to select the power.

5) Press  to select the power. The default power is 300W.

6) Turn  to select 700W,450W,300W and 100W.





7) Press  to select the time setting mode. The default time is 10 minutes.

8) Turn  to select the cooking time. The MAX time is 90 minutes.

9) Press **START** "PAUSE" button to start cooking.

8. Microwave + Convection Cooking

1) Press the **"ON/OFF"** button to activate the microwave function.

2) Turn  to select the convection mode.  and  will light. The default temperature is 180 degrees.  lights.

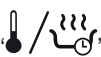
3) Press  to enter to the temperature selection.

4) Turn  to select the temperature between 50 to 230 degrees.

5) Press  to select the power. The default power is 300W.

6) Turn  to select 700W,450W,300W and 100W.





7) Press  to select the time setting mode. The default time is 10 minutes.

8) Turn  to select the cooking time. The MAX time is 90 minutes.

9) Press **START** "PAUSE" button to start cooking.

9. Microwave + Grill Fan Cooking

1) Press the **"ON/OFF"** button to activate the microwave function.

2) Turn  to select the combination mode.  and  will light. The default temperature is 180 degrees.  indicator will light when this function is selected.

3) Press  to enter to the temperature selection.

4) Turn  to select the temperature between 100 to 230 degrees.

5) Press  to select the power. The default power is 300W.

6) Turn  to select 700W,450W,300W and 100W.

7) Press  to select the time setting mode. The default time is 10 minutes.











8) Turn  to select the cooking time. The MAX time is 90 minutes.

9) Press **START** "PAUSE" button to start cooking.

Start-up and use

EN

10. Microwave + Bottom + Convection Cooking



- 1) Press the **"ON/OFF"** button to activate the microwave function.
- 2) Turn  to select the combination mode.  and  will light. The default temperature is 180 degrees.  indicator will light when this function is selected.
- 3) Press  to enter to the temperature selection.
- 4) Turn  to select the temperature between 100 to 230 degrees.
- 5) Press  to select the power. The default power is 300W.
- 6) Turn  to select 700W,450W,300W and 100W.
- 7) Press  to select the time setting mode. The default time is 10 minutes.
- 8) Turn  to select the cooking time. The MAX time is 90 minutes.

START

- 9) Press **"PAUSE"** button to start cooking.

11. Auto Cook

There are 14 automatic cooking programs. You only have to choose the program and set the weight. The power, the time and the temperature are already set.

- 1) Press the **"ON/OFF"** button to activate the microwave function.
- 2) Turn  to select the auto mode.  or  will light when defrost auto menu selected. Time, weight, the first number of the automatic programs are shown in the display. "d01" or "P01", "P02"...."P13" will display.

- 3) Press  button.

- 4) Turn  to select weight of the menu.

START

- 5) Press **"PAUSE"** button to start cooking.

Program	Category	Item
Defrost **	Meat	If you hear a beep, the combi microwave oven stops. Turn the food and press the start/pause button to continue the defrosting program.
P01**	Vegetables	Fresh vegetables
P02**	Side dishes	Potatoes - peeled/cooked
P06*	Side dishes	Potatoes – roasted If you hear a beep, turn the food. The combi microwave oven starts the next phase automatically.
P07	Poultry/ Fish	Chicken pieces/ Fish pieces If you hear a beep, turn the food. The combi microwave oven starts the next phase automatically.
P08*	Bakery	Cake
P09*	Bakery	Apple pie
P10*	Bakery	Quiche
P03**	Reheat	Drink/soup
P04**	Reheat	Plated meal
P05**	Reheat	Sauce/stew/dish
P11*	Convenience	Frozen - pizza
P12*	Convenience	Oven chips If you hear a beep, turn the food. The combi microwave oven starts the next phase automatically.
P13*	Convenience	Frozen - lasagne

- The programmes with a * are preheated. During preheating, the cooking time pauses and the preheating symbol is on. After preheating, you will hear an alarm and the preheating symbol will blink.
- The programmes with ** only use the microwave function.

12. Preheating Function

The preheating function can be activated after you have chosen the functions: Convection, Grill fan, bottom -convection, MW-convection, MW-Grill fan and Microwave -Bottom-convection.





- 1) Press “**START**” button.
The preheat icon appears in the display.
- 2) Press “**PAUSE**” button to start preheating.
If the right temperature is reached, you will hear three beeps. You can stop the preheating by opening the oven door or by pressing the “**ON/OFF**” button.

Note:

1. The preheating function only works if you have already chosen one of the modes above. During preheating, the microwave function is switched off.
2. Only when you can hear alarm and preheating icon is blinking you can open the door and put food inside.

13. Lock-out Function for Children

Lock: In waiting state, press “**START**” and “ / ” at the same time, there will be a long “beep” denoting entering into the children-lock state and “” indicator will light.

Unlock: In locked state, press “**START**” and “ / ” for 3 seconds, there will be a long “beep” denoting that the lock is released, and “” indicator will disappear.

Note: Child lock can be selected only before selecting a function.

14. Display Specification

- (1) When setting, if no other operation, it will confirm automatically after 10 seconds.
Except clock setting for the first time.
- (2) During setting program, after adjusted for 3 seconds, it will confirm automatically.
- (3) When the oven is in setting state or pause state, including auto menu and defrost program, if no operation in 5 minutes, it will enter into the off state.
- (4) The oven lamp will light all the time if the door is open.
- (5) The oven lamp will light all the time if the oven is paused.
- (6) “**START**” “**PAUSE**” button must be pressed to continue cooking if the oven door is open during cooking process.

Important safety instructions

EN

WARNING

To reduce the risk of fire, electric shock, injury to persons or exposure to excessive microwave oven energy when using your appliance, follow basic precautions, including the following:

1. Warning: Liquids and other foods must not be heated in sealed containers since they are liable to explode.
2. Warning: It is hazardous for anyone other than a competent person to carry out any service or repair operation that involves the removal of a cover which gives protection against exposure to microwave energy.
3. This appliance can be used by children aged from 8 years and above and persons with reduced physical, sensory or mental capabilities or lack of experience and knowledge if they have been given supervision or instruction concerning use of the appliance in a safe way and understand the hazards involved. Children shall not play with the appliance. Cleaning and user maintenance shall not be made by children unless they are older than 8 and supervised.
4. Keep the appliance and its cord out of reach of children less than 8 years.
5. Only use utensils suitable for use in microwave ovens.
6. The oven should be cleaned regularly and any food deposits should be removed.
7. Read and follow the specific: "PRECAUTIONS TO AVOID POSSIBLE EXPOSURE TO EXCESSIVE MICROWAVE ENERGY".
8. When heating food in plastic or paper containers, keep an eye on the oven due to the possibility of ignition.
9. If smoke is observed, switch off the appliance and keep the door closed in order to stifle any flames.
10. Do not overcook food.
11. Do not use the oven cavity for storage purposes. Do not store items, such as bread, cookies, etc. inside the oven.
12. Remove wire twist-ties and metal handles from paper or plastic containers/bags before placing them in the oven.
13. Install or locate this oven only in accordance with the installation instructions provided.
14. Eggs in the shell and whole hard-boiled eggs should not be heated in microwave ovens since they may explode, even after microwave heating has ended.

15. This appliance is intended to be used in household and similar applications such as:
 - staff kitchen areas in shops, offices and other working environments;
 - by clients in hotels, motels and other residential type environments;
 - farm houses;
 - bed and breakfast type environments.
16. If the supply cord is damaged, it must be replaced by the manufacturer, its service agent or similarly qualified persons in order to avoid a hazard.
17. Do not store or use this appliance outdoors.
18. Do not use this oven near water, in a wet basement or near a swimming pool.
19. The temperature of accessible surfaces may be high when the appliance is operating. The surfaces are liable to get hot during use. Keep cord away from heated surface, and do not cover any vents on the oven.
20. Do not let cord hang over edge of table or counter.
21. Failure to maintain the oven in a clean condition could lead to deterioration of the surface that could adversely affect the life of the appliance and possibly result in a hazardous situation.
22. The contents of feeding bottles and baby food jars shall be stirred or shaken and the temperature checked before consumption, in order to avoid burns.
23. Microwave heating of beverages can result in delayed eruptive boiling, therefore care must be taken when handling the container.
24. The appliance is not intended for use by persons (including children) with reduced physical, sensory or mental capabilities, or lack of experience and knowledge, unless they have been given supervision or instruction concerning use of the appliance by a person responsible for their safety.
25. Children should be supervised to ensure that they do not play with the appliance.
26. The appliances are not intended to be operated by means of an external timer or separate remote-control system.
27. Accessible parts may become hot during use. Young children should be kept away.
28. Steam cleaner is not to be used.
29. During use the appliance becomes hot. Care should be taken to avoid touching heating elements inside the oven.

Important safety instructions

EN

30. Only use the temperature probe recommended for this oven.(for ovens provided with a facility to use a temperature-sensing probe.)
31. **WARNING:** The appliance and its accessible parts become hot during use. Care should be taken to avoid touching heating elements. Children less than 8 years of age shall be kept away unless continuously supervised.
32. The microwave oven must be operated with the decorative door open.(for ovens with a decorative door.)
33. Surface of a storage cabinet can get hot.

READ CAREFULLY AND KEEP FOR FUTURE REFERENCE

Utensils

EN

See the instructions on “Materials you can use in microwave oven or to be avoided in microwave oven.”

There may be certain non-metallic utensils that are not safe to use for microwaving. If in doubt, you can test the utensil in question following the procedure below.

Utensil Test:

- 1) Fill a microwave-safe container with 1 cup of cold water (250ml) along with the utensil in question.
- 2) Cook on maximum power for 1 minute.
- 3) Carefully feel the utensil. If the empty utensil is warm, do not use it for microwave cooking.
- 4) **Do not exceed 1 minute cooking time.**

Materials you can use in microwave oven

Utensils	Remarks
Aluminum foil	Shielding only. Small smooth pieces can be used to cover thin parts of meat or poultry to prevent overcooking. Arcing can occur if foil is too close to oven walls. The foil should be at least 1 inch (2.5cm) away from oven walls.
Browning dish	Follow manufacturer's instructions. The bottom of browning dish must be at least 3/16 inch (5mm) above the turntable. Incorrect usage may cause the turntable to break.
Dinnerware	Microwave-safe only. Follow manufacturer's instructions. Do not use cracked or chipped dishes.
Glass jars	Always remove lid. Use only to heat food until just warm. Most glass jars are not heat resistant and may break.
Glassware	Heat-resistant oven glassware only. Make sure there is no metallic trim. Do not use cracked or chipped dishes.
Oven cooking bags	Follow manufacturer's instructions. Do not close with metal tie. Make slits to allow steam to escape.
Paper plates and cups	Use for short-term cooking/warming only. Do not leave oven unattended while cooking.
Paper towels	Use to cover food for reheating and absorbing fat. Use with supervision for a short-term cooking only.
Parchment paper	Use as a cover to prevent splattering or a wrap for steaming.
Plastic	Microwave-safe only. Follow the manufacturer's instructions. Should be labeled “Microwave Safe”. Some plastic containers soften, as the food inside gets hot. “Boiling bags” and tightly closed plastic bags should be slit, pierced or vented as directed by package.
Plastic wrap	Microwave-safe only. Use to cover food during cooking to retain moisture. Do not allow plastic wrap to touch food.
Thermometers	Microwave-safe only (meat and candy thermometers).
Wax paper	Use as a cover to prevent splattering and retain moisture.

Materials to be avoided in microwave oven

Utensils	Remarks
Aluminum tray	May cause arcing. Transfer food into microwave-safe dish.
Food carton with metal handle	May cause arcing. Transfer food into microwave-safe dish.
Metal or metal-trimmed utensils	Metal shields the food from microwave energy. Metal trim may cause arcing.
Metal twist ties	May cause arcing and could cause a fire in the oven.
Paper bags	May cause a fire in the oven.
Plastic foam	Plastic foam may melt or contaminate the liquid inside when exposed to high temperature.
Wood	Wood will dry out when used in the microwave oven and may split or crack.

Cleaning

EN

Be sure to disconnect the appliance from the power supply.

- 1) Clean the inside of the oven after using with a slightly damp cloth.
- 2) Clean the accessories in the usual way in soapy water.
- 3) The door frame and seal and neighboring parts must be cleaned carefully with a damp cloth when they are dirty.
4. Do not use harsh abrasive cleaners or sharp metal scrapers to clean the oven door glass since they can scratch the surface, which may result in shattering of the glass.
5. Cleaning Tip---For easier cleaning of the cavity walls that the food cooked can touch: Place half a lemon in a bowl, add 300ml (1/2 pint) water and heat on 100% microwave power for 10 minutes.
Wipe the oven clean using a soft, dry cloth.

Troubleshooting

EN

Problem

Microwave oven interfering TV reception

Dim oven light.

Steam accumulating on door, hot air out of vents.

Oven started accidentally with no food in.

Oven can not be started.

Oven does not heat.

Glass turntable makes noise when microwave oven operates

Possible causes/Remedy

- Radio and TV reception may be interfered when microwave oven operating. It is similar to the interference of small electrical appliances, like mixer, vacuum cleaner, and electric fan. It is normal.
- In low power microwave cooking, oven light may become dim. It is normal.
- In cooking, steam may come out of food. Most will get out from vents. But some may accumulate on cool place like oven door. It is normal.
- It is forbidden to run the unit without any food inside. It is very dangerous.
- Power cord not securely connected.
- Switch off for 10 seconds, then reconnect.
- Fuse blowing or circuit breaker works.
Replace fuse or reset circuit breaker (repaired by professional personnel).
- Door not closed well. Close door well.
- Dirty roller rest and oven bottom.
Refer to "Maintenance of Microwave" to clean dirty parts.

Before contacting the After Sales Service:

- make sure you can't fix the anomaly yourself;
 - if you can't, contact an authorized Technical Assistance Service.
- ! Never engage non-authorized technicians.

Report:

- the type of anomaly;
- the oven model (Mod.);
- the serial number (S/N).

This information is on the ratings plate on the Microwave Oven.

Guarantee

12 Months Parts and Labour Guarantee

Your appliance has the benefit of our manufacturer's guarantee, which covers the cost of breakdown repairs for twelve months from the date of purchase.

This gives you the reassurance that if, within that time, your appliance is proven to be defective because of either workmanship or materials, we will, at our discretion, either repair or replace the appliance at no cost to you.

This guarantee is subject to the following conditions:

- The appliance has been installed and operated correctly and in accordance with our operating and maintenance instructions.
- The appliance is used only on the electricity or gas supply printed on the rating plate.
- The appliance has been used for normal domestic purposes only.
- The appliance has not been altered, serviced, maintained, dismantled, or otherwise interfered with by any person not authorised by us.
- Any repair work must be undertaken by us or our appointed agent.
- Any parts removed during repair work or any appliance that is replaced become our property.
- The appliance is used in the United Kingdom or Republic of Ireland.

The guarantee does not cover:

- Damage resulting from transportation, improper use, neglect or interference or as a result of improper installation.
- Replacement of any consumable item or accessory . These include but are not limited to: plugs, cables, batteries, light bulbs, fluorescent tubes and starters, covers and filters.
- Replacement of any removable parts made of glass or plastic.

THIS GUARANTEE WILL NOT APPLY IF THE APPLIANCE HAS BEEN USED IN COMMERCIAL OR NON-DOMESTIC PREMISES.

5 Year Parts Guarantee

Hotpoint also offers you a free 5 year parts guarantee. This additional guarantee is conditional on you registering your appliance with us and the parts being fitted by one of our authorised engineers. There will be a charge for our engineer's time. To activate the extra parts warranty on your appliance, simply call our registration line on **08448 242424 (Republic of Ireland 01 230 0233)**.

Extended Guarantees

We offer a selection of repair protection plans that enable you to fully cover yourself against the expense of repair bills for the life of your policy. To find the ideal plan for you please call our advice line on **08448 226 226 (Republic of Ireland 01 230 0233)**.

Helpdesk Service

We have a dedicated team who can provide free advice and assistance with your appliance if you experience any technical difficulties within the first 90 days of ownership. Simply call our Hotpoint Service Hotline on **08448 224 224 (Republic of Ireland 0818 313 413)** for telephone assistance, or, where necessary, to arrange for an engineer to call. If we cannot resolve the technical problem we will replace your machine or, if you prefer, give you your money back.

After Sales Service

We pride ourselves on ensuring that you and your Hotpoint appliance receive the very highest level of service. No one understands Hotpoint appliances like we do, so for service from the people that know your appliance best, simply call 08448 224 224.

Our operators are on hand to answer your call every day including weekends and bank holidays. Our team of 1000 technicians are the largest white goods service organisation in the UK and Ireland available to provide fast, reliable and local service. They have all undergone extensive training at our Training Centre of Excellence and are equipped with the latest diagnostic tools to deliver expert servicing of your Hotpoint appliance.

UK: 08448 224 224
Republic of Ireland: 0818 313 413
or visit
www.hotpointservice.co.uk

Model number:

Serial number:

Parts and Accessories

We supply a full range of genuine replacement parts as well as accessory products that protect and hygienically clean your appliance to keep it looking good and functioning efficiently throughout its life.

UK: 08448 225 225
Republic of Ireland: 0818 313 413
or visit
www.hotpointservice.co.uk

Appliance Registration

We want to give you additional benefits of Hotpoint ownership. To activate your free 5 year parts guarantee you must register your appliance. By registering your appliance with us not only do you activate the guarantee all your information will be logged onto our repair system. In the unfortunate event that you need assistance we will have your appliance details to hand when you call us.

UK: 08448 24 24 24
Republic of Ireland: 01 230 0800
or visit
www.hotpointservice.co.uk

Indesit Company UK Ltd. Morley Way, Peterborough, PE2 9JB
Indesit Ireland Ltd. The Crescent Building, Northwood Park, Santry, Dublin 9.

Recycling & Disposal Information

As part of Hotpoint's continued commitment to helping the environment, Hotpoint reserves the right to use quality, recycled components to keep down customer costs and minimise material wastage. Please dispose of packaging and old appliances carefully. To minimise the risk of injury to children, remove the door and cut the mains cable off flush with the appliance. Dispose of these parts separately to ensure that the appliance can no longer be connected to the mains supply, and the door cannot be locked shut.

Indesit Company S.p.A.
Viale Aristide Merloni, 47
60044 Fabriano (AN)