

说明书递交文档

设计 DESIGN	刘克亮 2013. 6. 4	图纸名称 PART NAME INDESIT CTAA 55 NF UK (CE-BCD259W-S)说明书				图号/物料编码 PART NO. 50200101C564	
校对 CO. BY	毛娅男					材料 MATERIAL 封面120g、内文80g双胶纸	
标准化 STANDARD	马凯						
业务 seller	曹筱峰	图样标记 REL	版本号 REV. NO.	重量(g) WEIGHT	比例 scale	美的冰箱事业部 MIDEA REFRIGERATION DIVISION	
批准 AUTHORIZE	于清		5		1:1		
		共 页 TOTAL SHEETS		第 页 NO. OF SHEETS			

技术要求

1. 尺寸：16K
2. 印刷颜色：封面彩色，内文灰度
3. 样板需送设计部门封样
- 4.

标记 MARKER	变更内容	修改日期	签名
①	自2014. 1. 10铭牌上的化霜功率与与毛容积有更改	2014. 1. 10	周军
②	自428689订单增加客户型号	2014. 5. 15	周军
③	自428689订单增加客户型号，第八页，第十页与十二页内容有更改	2014. 5. 16	周军
④	自2014. 5. 19增加客户型号	2014. 5. 19	周军
⑤	自428689订单修改目录与第八页的内容	2014. 5. 19	周军



Indesit Company S.p.A.

Viale Aristide Merloni, 47
60044 Fabriano (AN) Italy
Tel. +39 0732 6611
www.indesit.com





English,1

CTAA 55 NF UK
CTAA 55 NF K UK
CTAA 55 NF S UK
BCTAA 55 NF

TABLE OF CONTENTS

PARTS	2
UNPACKING YOUR REFRIGERATOR-FREEZER	4
SPACE REQUIREMENTS	4
ELECTRICAL REQUIREMENT	4
RECOMMENDED EARTHING METHOD	4
USE OF THE APPLIANCE	5
TEMPERATURE CONTROLI	5
CHANGING THE BULBS	5
POWER INTERRUPTIONS	5
Maintaining Your Refrigerator-freezer	6
PROLONGED OFF PERIODS	6
Refrigerator-freezer door install guidelines about swapping left&right	7
TROUBLE SHOOTING	9
WARNING	10
ASSISTANCE	11

DEAR CUSTOMER:

Thank you for buying this refrigerator-freezer. To ensure that you get the best results from your new refrigerator-freezer, please take time to read through the simple instructions in this booklet.

Please ensure that the packing material is disposed of in accordance with the current environmental requirements.

When disposing of any refrigerator-freezer equipment please contact your local waste disposal department for advice on safe disposal.

This appliance must be only used for its intended purpose.

CAUTION :

The appliance is not intended for use by young children or infirm persons without supervision.

Young children should be supervised to ensure that they do not play with the appliance.

GENERAL :

This type of refrigerator-freezer is widely used in places such as hotels ,offices, student dormitories and houses. It is mostly suitable for refrigerating and preserving foods such as fruits and beverage. It enjoys the advantages of small size, Lightweight, Low electric consumption and easy use.

PARTS

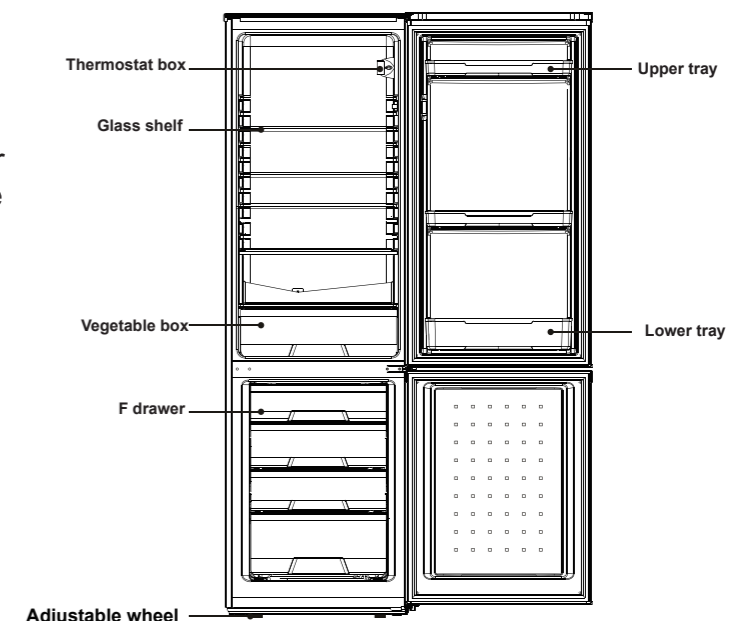

REFRIGERATOR-FREEZER

Plug replacement(UK&Ireland only)

Should you need to replace the plug, the wires in the power cable are colour in the following way:

Blue - Neutral 'N'

Brown - Live 'L'

Green&Yellow - Earth 'E'

As the colours of the wires in the power cable may not correspond with the coloured markings identifying the terminals in your plug, and proceed as follows:

The green&yellow wire must be connected to the terminal in the plug that is marked with the letter E or by the earth symbol.

The blue wire must be connected to the terminal that is marked with the letter N.

The brown wire must be connected to the terminal that is marked with the letter L.

If power supply cord is damaged, it must be replaced by the manufacturer or its service agent or a similar qualified person in order to avoid a hazard.

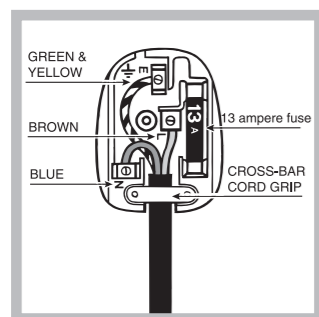

Disposal

- Observe local environmental standards when disposing packaging material for recycling purposes.
- The European Directive 2002/96/EC on Waste Electrical and Electronic Equipment (WEEE), requires that old household electrical appliances must not be disposed of in the normal unsorted municipal waste stream. Old appliances must be collected separately in order to optimise the recovery and recycling of the materials they contain and reduce the impact on human health and the environment. The crossed out "wheeled bin" symbol on the product reminds you of your obligation, that when you dispose of the appliance it must be separately collected. Consumers should contact their local authority or retailer for information concerning the correct disposal of their old appliance.

Respecting and conserving the environment

- Install the appliance in a fresh and well-ventilated room. Ensure that it is protected from direct sunlight and do not place it near heat sources.
- Try to avoid keeping the door open for long periods or opening the door too frequently in order to conserve energy.
- Do not fill the appliance with too much food: cold air must circulate freely for food to be preserved properly. If circulation is impeded, the compressor will work continuously.
- Do not place hot food directly into the refrigerator. The internal temperature will increase and force the compressor to work harder and will consume more energy.
- Defrost the appliance if ice forms (see Maintenance). A thick layer of ice makes cold transference to food products more difficult and results in increased energy consumption.

UNPACKING YOUR REFRIGERATOR-FREEZER

WARNING: Use two or more people to move refrigerator-freezer. Failure to do so can result in back or other injury.

Remove tape and any labels from your refrigerator-freezer before using (except the rating label).

To remove any remaining tape or glue, rub the area briskly with your thumb.

Tape or glue residue can also be easily removed by rubbing a small amount of liquid dish soap over the adhesive with your fingers. Wipe with warm water and dry.

Do not use sharp instruments, rubbing alcohol, flammable fluids, or abrasive cleaners to remove tape or glue. These products can damage the surface of your refrigerator-freezer.

When moving the refrigerator-freezer, do not tilt the refrigerator-freezer beyond 45° from upright position

CLEANING BEFORE USE :

After you remove all of the packaging materials, (especially the foam between outside condenser and cabinet should be removed) clean the inside of your refrigerator-freezer before using it.

SPACE REQUIREMENTS

WARNING: Keep flammable materials and vapors, such as gasoline, away from refrigerator-freezer. Failure to do so can result in death, explosion, fire or burns.

To ensure proper ventilation for your refrigerator-freezer, allow for 200mm space on each side between walls, 200mm space between back of your refrigerator-freezer and the wall, and 300mm space between counter top and the roof or ceiling.

If you are installing your refrigerator-freezer next to a fixed wall, leave sufficient space on

REFRIGERATOR-FREEZER

the hinge side to allow for the door to swing open.

Never install your refrigerator-freezer near heat source and direct sun shines.

ELECTRICAL REQUIREMENT
WARNING: DO NOT REMOVE GROUND PRONG.

DO NOT USE AN ADAPTOR.
DO NOT USE EXTENSION CORD.

Failure to follow these instructions can result in death, fire or electrical shock.

Before you move your refrigerator-freezer into its final location, it is important to make sure you have the proper electrical connection.

RECOMMENDED EARTHING METHOD
AC220-240Volt /50Hz ,AC only 10 ampere fused and properly earthed electrical supply is required. It is recommended that a separate circuit serving only this appliance be provided.

Use a receptacle which cannot be turned off with a switch or pull chain. Do not use an extension cord.

NOTE: Before performing any type of installation, disconnect the refrigerator-freezer from the electrical source. When you are finished, connect the refrigerator-freezer to the electrical source and reset the control to the desired setting.

LEVELING

If the refrigerator-freezer is not leveled during installation. The doors may not close or seal properly, causing cooling, frost, or moisture problems. It is very important of the refrigerator-freezer to be level in order to function properly.

To level your refrigerator-freezer you may either turn the adjustable foot clockwise to raise that side to the refrigerator-freezer or turn counter – clockwise to lower that side.

NOTE: Having someone push against the top of the refrigerator-freezer, take some weight off. This makes it easier to adjust the adjustable foot.

REFRIGERATOR-FREEZER

USE OF THE APPLIANCE

To obtain the best possible results from your refrigerator-freezer, it is important that you use it properly.

TEMPERATURE CONTROL

The temperature in the refrigerator-freezer is controlled by the thermostat control knob.

The temperature inside the refrigerator-freezer automatically adjusts itself according to the position of the thermostat knob.

Min=warmest Max=coldest

We recommend, however, the medium position. "OFF" position means stop work.

LED LIGHT REPLACEMENT

If the led light need to be replaced, please contact the Technical Assistance Service.

POWER INTERRUPTIONS

If the electricity in your house goes off for a shorter period, keep both doors closed to help foods stay cold and frozen.

If the power will be out for a longer period, remove foods from the freezer and stored it in a frozen food locker.

Fresh Food Storage

Wrap or store food in the refrigerator in airtight and moisture – proof material.

This prevents food odor and taste transfer throughout refrigerator.

- Fruit – wash, let dry and store in refrigerator in plastic bags or crisper.
- Leafy vegetables- Remove wrapping and trim or tear off bruised and discolored areas, wash in cold water and drain. Place in plastic bag or plastic container and store in crisper.
- Fish –Use fresh fish the same day as purchased.
- Meat – Store most meat in original wrapping as long as it is airtight and moisture – proof.
Re – wrap if necessary.
- Leftovers – Cover leftovers with plastic wrap or aluminum foil. Plastic containers with tight lid can also be used.

Frozen Food Storage

When using the refrigerator-freezer for the first time, set the thermostat control knob on "Max" for at least two hours before introducing the food to be stored.

All frozen food products you purchase should be placed in the freezer compartment as soon as possible to avoid the frozen food from defrosting.

Storage recommendation printed on the packaging of frozen food by the manufacturers should be always be followed.

REFRIGERATOR-FREEZER

Freezing Fresh Food

Ensure that your freezing operations are carried out under the most hygienic conditions as freezing alone does not sterilize the food. It is advisable to freeze the food by packing it into separate meal portions and not in bulk form. Never put hot or even warm foodstuffs into the freezer compartment. Prior to storing the frozen food, pack it in plastic bags, aluminum sheets or freezing containers and place into the freezer compartment. The maximum quantity of food that may be frozen daily is indicated on the plate containing the technical properties located on the back of the refrigerator-freezer.

Note: Never put bottled food or drinks in the freezer compartment. For best performance, leave enough space in the Freezer compartment for air to circulate around the packages.

Maintaining Your Refrigerator-freezer

The refrigerator-freezer should be clean at least once a month to avoid mould and unpleasant odours.

During cleaning and maintenance it is necessary to disconnect the appliance from the electricity supply.

- Set the thermostat control knob on "OFF"
- Pull the plug out of the socket
- Remove all movable parts from inside, such as shelves and crisper. Etc. Internal parts may be soaked in warm water and neutral soap.
- clean using a soft sponge that has been soaked in lukewarm water and bicarbonate of soda or neutral soap. Do not use solvents, abrasive products, bleach or ammonia.
- Hand wash, rinse and dry all surfaces thoroughly.

- Do not use cleaning waxes, concentrated detergents, bleaches or cleaners containing petroleum on plastics and rubber parts.

- Never use paper towels, window sprays, scouring cleansers or flammable fluids on plastic parts as these can scratch or damage material.

PROLONGED OFF PERIODS

If the refrigerator-freezer is not in use for a long period of time, proceed as follows: Disconnect the refrigerator-freezer from the main supply by removing the plug from the wall socket.

Clean and dry the inside as instructed under the heading of cleaning the refrigerator-freezer.

Leave the door open to prevent any unpleasant smells from building up while the refrigerator-freezer is not in use.

REFRIGERATOR-FREEZER

Refrigerator-freezer door install guidelines about swapping left&right

1. Remove the top bar cover fixed by four screws with caps, then take off two top endcap coverslips and a top cover buckle

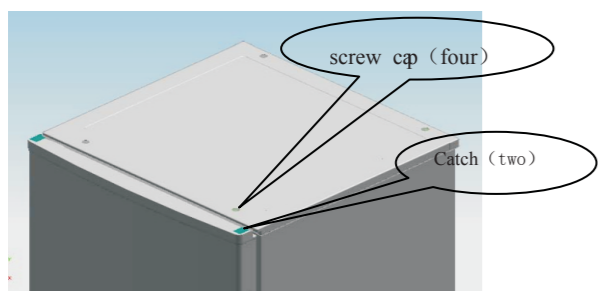

2. Remove three screws of the top hinge, take the door hinge as axis, turn over the top hinge in clockwise direction, then the top hinge could be removed. Take off the top door, and put it aside.

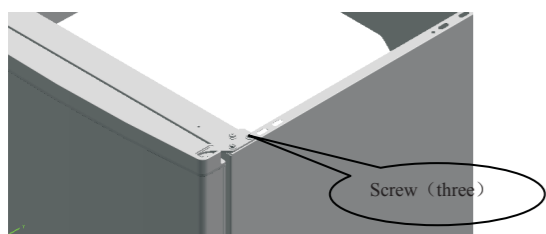

3. Remove middle hinge, screws, screw caps and plastic inserting nails. Install them on the other side. Take off the lower door and put it away.



4. The disassembly and installation of bottom parts

A. Disassemble lower hinge and screws. Then install them on the other side and consolidate the lower hinge.

Note : the refrigerator-freezer incline angle less 45°.

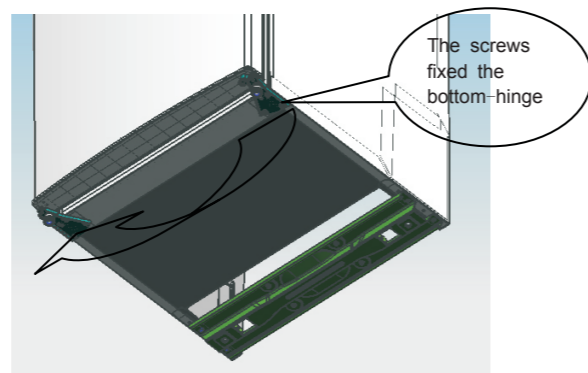

B. Swap over the position of the adjustable foot to the other side of the cabinet.

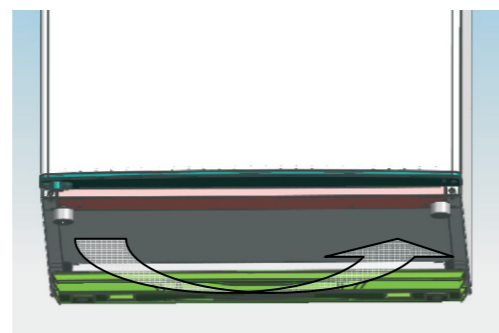

C. Swap over the position of the lower door block to the other side, And install the screws and consolidate them.

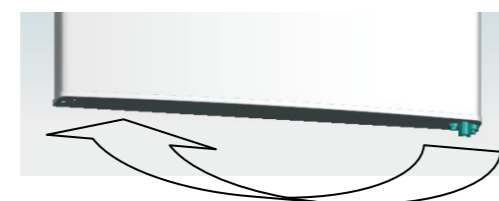

5. Install the lower door

6. Tighten the screws of the middle hinge on the reversible side.

7. Remove the existing top door block. Install a new top door block (not the same one) on the reversible side. Screw it down, Install the top door.

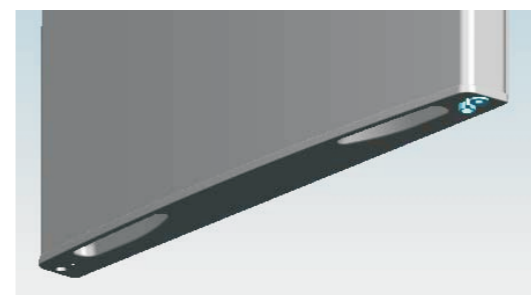

8. Reuse the disassembled top hinge, three screws and hinge shaft sleeve.

A. Disassemble the axis of the hinge, swap over its position to the other side, then consolidates the axis and screws it down

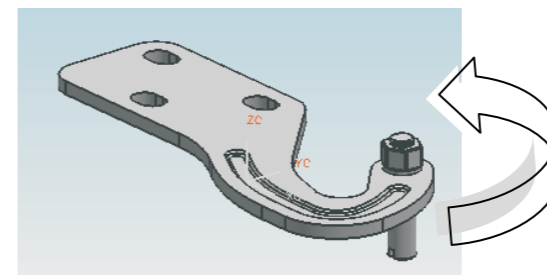

B. Install the assembled top hinge. Screw it down and fix it on target side

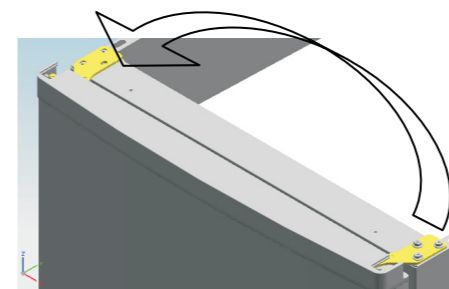

REFRIGERATOR-FREEZER

9. Install the top bar cover and a top cover buckle. Screw down the four screws and cover them with caps. Finally insert the top endcap coverslip

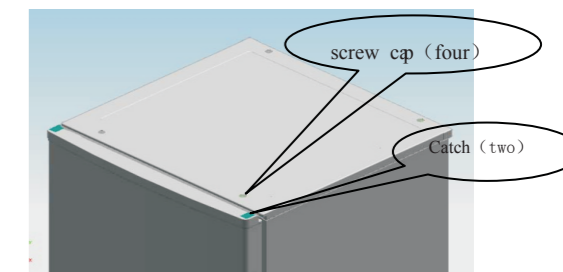

Attachment :

1. Components that could be transferred from one side to the other directly after disassembling are listed below:

- top door top endcap coverslip (2pcs)
- top cover buckle (1pc)
- hinge shaft sleeve (1 or 2pcs)
- screws of top hinge (3 pcs)
- middle hinge assembly (1 pc)
- screws of middle hinge (2 pcs)
- insert nail (2 pcs)
- screw cap (2 pcs)
- door stopper (1 pc)
- bottom hinge assembly (1 pc)
- screws of lower hinge (3pcs)

2. The component that could be swapped over from one side to the other only after reconstruction is listed below :

top hinge assembly

3. Components that could be swapped over from one side to the other in pairs are listed below:

- adjustable foot with internal thread (used with the lower hinge)
- adjustable foot with bolt (fixed at the bottom)

REFRIGERATOR-FREEZER

4. Components that could not be reused temporarily are listed below:

left block on top door
right block on top door

- Ensure the Appliance is unplugged and empty.

- Adjust the two leveling feet to their highest position.

- We recommend you have someone to assist you.

NOTE :

To take the door off it is necessary to tilt the Appliance backward.

You should rest the Appliance on something solid e.g. a chair just below the top panel.

Do not lay the Appliance completely flat as this may damage the coolant system.

TROUBLE SHOOTING

In case of malfunction, you can solve many common problems easily.

Your refrigerator-freezer will not operate... Check if

- The power supply cord is unplugged.

The doors will not close completely... Check if

- The drawers are out of position.

- The gaskets are dirty.

- The refrigerator-freezer is not level.

The refrigerator-freezer is noisy when running... Check if

- Check the refrigerator-freezer is level and it is not in contact with another appliance or kitchen furniture.

The refrigerator-freezer does not cool sufficiently... Check if

- If the door has been opened too often, or it has been left open for a while it will take time for the refrigerator-freezer to reach its set temperature.

- Check the airflow the rear of the refrigerator-freezer has not been reduced due to insufficient clearance.

The following characteristics should not be looked upon as a problem.

- A gentle tricking sound caused by coolant flowing the pipe.

Compressor operating at high temperature.

REQUESTING ASSISTANCE OR SERVICE

If the problem is not due to one of the items listed in Troubleshooting, Contact the dealer or authorized Service Company.

WARNING



Caution: risk of fire

RECOMMENDATIONS :

1) WARNING – Keep ventilation openings, in the appliance enclosure or in the built-in structure, clear of obstruction.

2) WARNING – Do not damage the refrigerant circuit.

3) WARNING – Do not use mechanical devices or other means to accelerate the defrosting process, other than those recommended by the manufacturer

3.1) WARNING – Do not use electrical appliances inside the food storage compartments of the appliance, unless they are of the type recommended by the manufacturer

3.2) Do not store explosive substances such as aerosol cans with a flammable propellant in this appliance

4) The appliance has to be unplugged after use and before carrying out user maintenance on the appliance.

5) This appliance is not intended for use by persons (including children) with reduced physical, sensory or mental capabilities, or lack of experience and knowledge, unless they have been given supervision or instruction concerning use of the appliance by a person responsible for their safety.

6) Children should be supervised to ensure that they do not play with the appliance.

7) If the supply cord is damaged, it must be replaced by the manufacturer, its service agent or similarly qualified persons in order to avoid a hazard.

REFRIGERATOR-FREEZER



Correct Disposal of this product :

This marking indicates that this product should not be disposed with other household wastes throughout the EU. To prevent possible harm to the environment or human health from uncontrolled waste disposal, recycle it responsibly to promote the sustainable reuse of material resources. To return your used device, please use the return and collection systems or contact the retailer where the product was purchased. They can take this product for environmental safe recycling.

Guarantee

After Sales Service

Recycling and Disposal Information

12 months Parts and Labour Guarantee

Your appliance has the benefit of our manufacturer's guarantee, which covers the cost of breakdown repairs for twelve months from the date of purchase.

This gives you the reassurance that if, within that time, your appliance is proven to be defective because of either workmanship or materials, we will, at our discretion, either repair or replace the appliance at no cost to you.

This guarantee is subject to the following conditions:

- The appliance has been installed and operated correctly and in accordance with our operating and maintenance instructions.
- The appliance is used only on the electricity or gas supply printed on the rating plate.
- The appliance has been used for normal domestic purposes only.
- The appliance has not been altered, serviced, maintained, dismantled, or otherwise interfered with by any person not authorised by us.
- Any repair work must be undertaken by us or our appointed agent.
- Any parts removed during repair work or any appliance that is replaced become our property.
- The appliance is used in the United Kingdom or Republic of Ireland.

The guarantee does not cover:

- Damage resulting from transportation, improper use, neglect or interference or as a result of improper installation.
- Replacement of any consumable item or accessory. These included but not limited to: plugs, cables, batteries, light bulbs, fluorescent tubes and starters, covers and filters.
- Replacement of any removable parts made of glass or plastic.

THIS GUARANTEE WILL NOT APPLY IF THE APPLIANCE HAS BEEN USED IN COMMERCIAL OR NON-DOMESTIC PREMISES.

5 Year Parts Guarantee

Hotpoint also offers you a free 5 year parts guarantee. This additional guarantee is conditional on you registering your appliance with us and the parts being fitted by one of our authorised engineers. There will be a charge for our engineer's time. To activate the extra parts warranty on your appliance, simply call our registration line on 08448 242424 (Republic of Ireland 01 230 0233).

Extended Guarantees

We offer a selection of protection plans that enable you to fully cover yourself against the expense of repair bills for the life of your policy. To find the ideal plan for you please call our advice line on 08448 226 226 (Republic of Ireland 01 230 0233).

Helpdesk Service

We have a dedicated team who can provide free advice and assistance with your appliance if you experience any technical difficulties within the first 90 days of ownership. Simply call our Hotpoint Service Hotline on 08448 224 224 (Republic of Ireland 0818 313 413) for telephone assistance, or, where necessary, to arrange for an engineer to call.

We pride ourselves on ensuring that you and your Hotpoint appliance receive the very highest level of service. No one understands Hotpoint appliances like we do, so for service from the people that know your appliance best, simply call 08448 224 224.

Our operators are on hand to answer your call every day including weekends and bank holidays. Our team of 1000 technicians are the largest white goods service organisation in the UK and Ireland available to provide fast, reliable and local service. They have all undergone extensive training at our Training Centre of Excellence and are equipped with the latest diagnostic tools to deliver expert servicing of your Hotpoint appliance.

UK: 08448 224 224
 Republic of Ireland: 0818 313 413
 or visit
www.hotpointservice.co.uk

Model number: _____

Serial number: _____

Parts and Accessories

We supply a full range of genuine replacement parts as well as accessory products that protect and hygienically clean your appliance to keep it looking good and functioning efficiently throughout its life.

UK: 08448 225 225
 Republic of Ireland: 0818 313 413
 or visit
www.hotpointservice.co.uk

Appliance Registration

We want to give you additional benefits of Hotpoint ownership. To activate your free 5 year parts guarantee you must register your appliance.

By registering your appliance with us not only do you activate the guarantee all your information will be logged onto our repair system. In the unfortunate event that you need assistance we will have your appliance details to hand when you call us.

UK: 08448 24 24 24
 Republic of Ireland: 01 230 0800
 or visit
www.hotpointservice.co.uk

Indesit Company UK Ltd. Morley Way, Peterborough, PE2 9JB
 Indesit Ireland Ltd. The Crescent Building, Northwood Park, Santry, Dublin 9.

As part of Hotpoint's continued commitment to helping the environment, Hotpoint reserves the right to use quality, recycled components to keep down customer costs and minimise material wastage. Please dispose of packaging and old appliances carefully. To minimise the risk of injury to children, remove the door, plug, and cut the mains cable off flush with the appliance. Dispose of these parts separately to ensure that the appliance can no longer be plugged into mains socket, and the door cannot be locked shut.

