

Neato XV™ Series Robot Vacuum User Guide

READ ALL INSTRUCTIONS BEFORE USING THIS APPLIANCE.

SAVE THESE INSTRUCTIONS.

PLEASE REFER TO PAGE 10 FOR ADDITIONAL SAFETY INSTRUCTIONS.



Neato Robotics, Inc.
8100 Jarvis Avenue Suite 100
Newark, CA 94560

Copyright © 2013 Neato Robotics, Inc. All rights reserved.

Neato Robotics is a registered trademark of Neato Robotics, Inc.

Table of Contents

Welcome!	5
Anatomy of Your Neato Vacuum	6
Important Safety Instructions	10
Likes and Dislikes	11
Turn to Run Mode	14
Using the Neato Vacuum	15
Using the Charging Base	16
Charging Status	20
Optimal Charging	20
Cleaning Mode	21
Quick-Start Your Robotic Vacuum	22
Using the Control Center LCD screen	24
Using Spot Mode for Cleaning Smaller Areas	26
Setting the Clock	28
Scheduling a Cleaning	30
To Get the Most of Scheduled Cleanings	32

Ideas for Scheduled Cleanings.....	33
Removing a Scheduled Cleaning.....	34
Changing the Language on the LCD Display.....	36
Pausing a Cleaning.....	37
Putting your Vacuum to Sleep.....	37
Turning off Your Vacuum.....	38
Emptying the Dirt Bin.....	39
Boundary Markers.....	41
Using boundary markers.....	41
Communicating with Your Neato Vacuum.....	42
Getting the Best Performance from Your Neato Vacuum.....	43
LCD Feedback Messages.....	44
Filters.....	47

Customer Support 49

Limited Warranty.....	50
Compliance Information.....	51
Declaration of Conformity.....	52
FCC COMPLIANCE STATEMENT.....	54
Disposal Notices.....	56
Neato Vacuum.....	56
Batteries.....	56
Linux Operating System.....	57

Welcome!

Thank you for purchasing your new Neato Vacuum. And welcome to the home robotics revolution.

This detailed user's guide will provide all you need to know. It's easy.

If you are in a hurry, and want to learn the basics to get started right away, you can read the Quick Start Guide. It's even easier.

We want to keep in touch.

To ensure that we keep you up to date on your new Neato Vacuum, please register at <http://www.neatorobotics.com>.

Neato is developing robotic home products that promise to free everyone from the drudgery of household cleaning.

Anatomy of Your Neato Vacuum

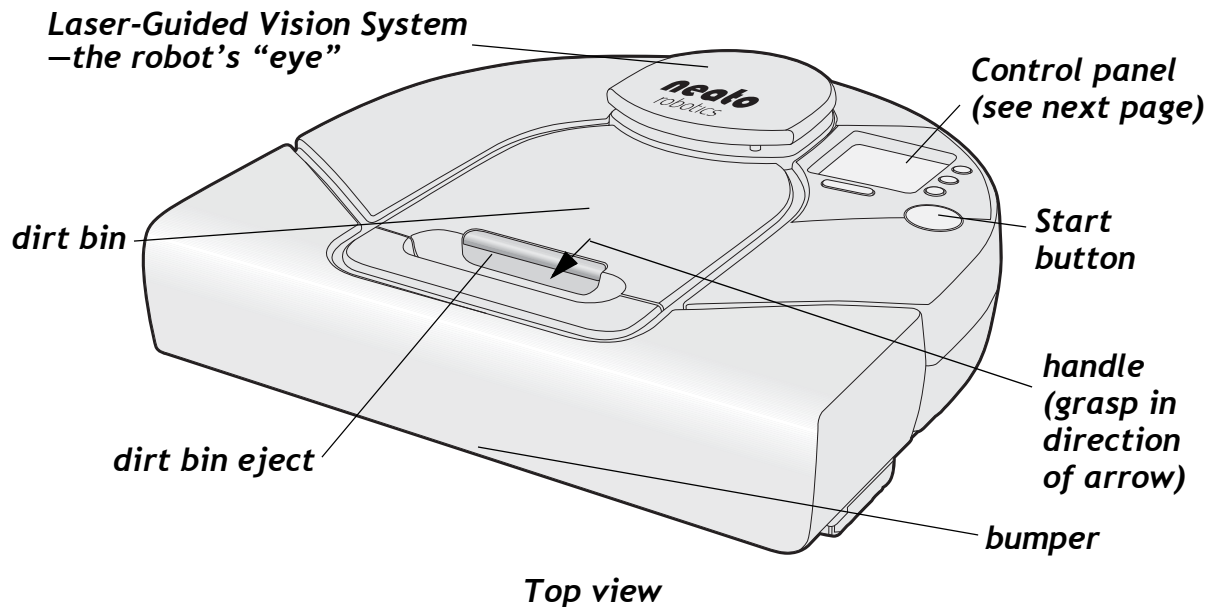

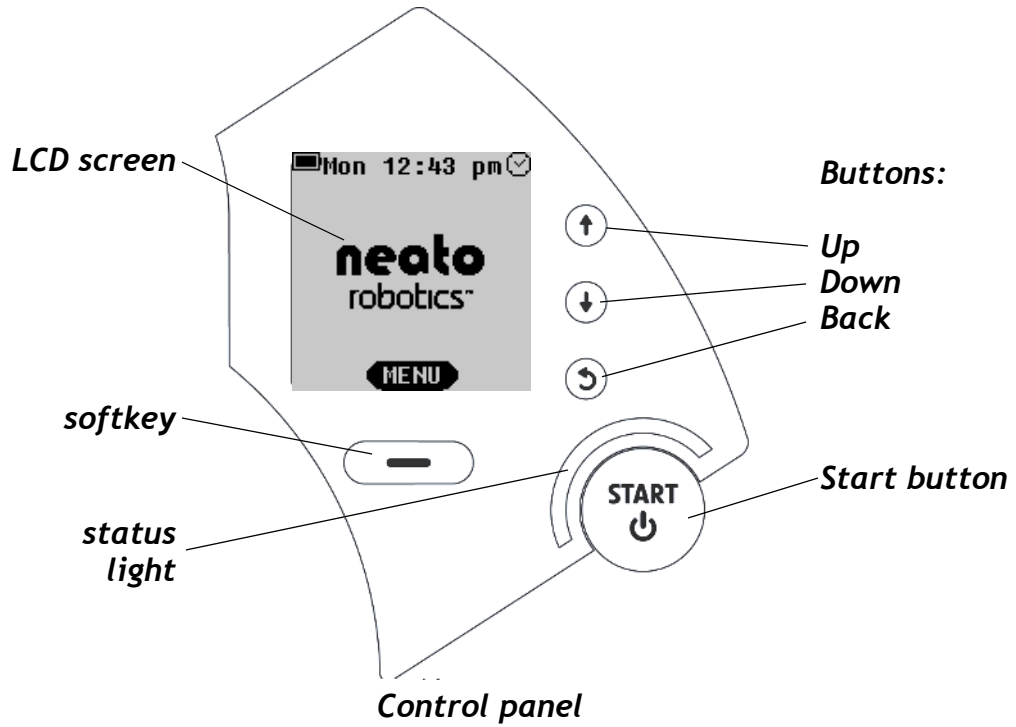

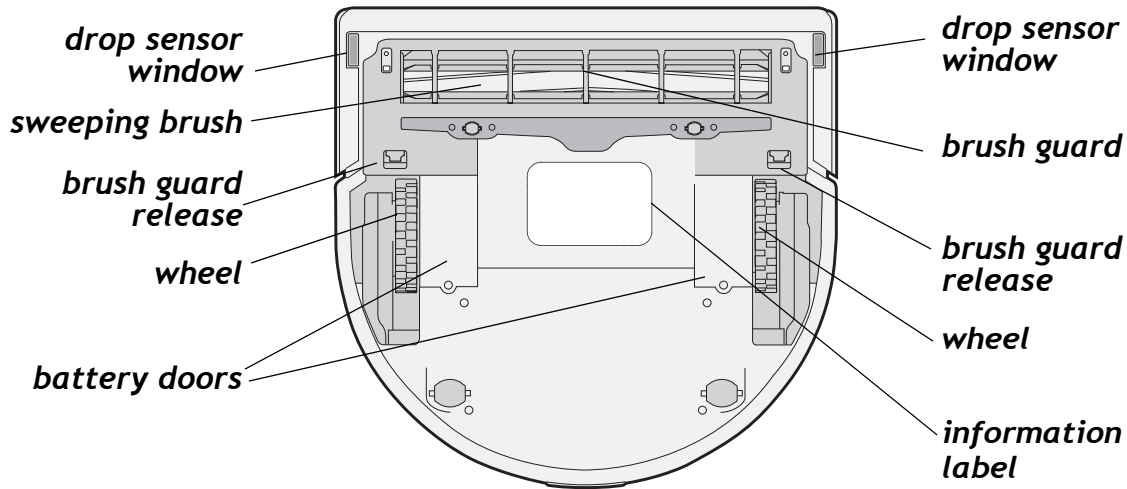

Bottom view

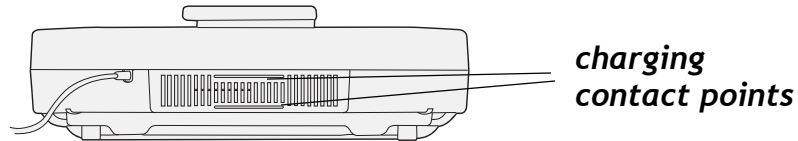

Back View

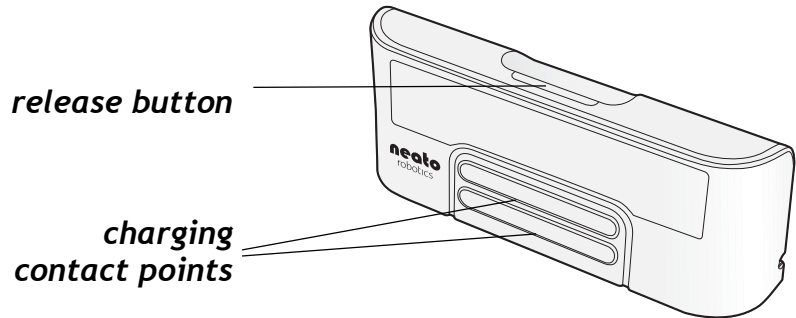

Charging base (external view)

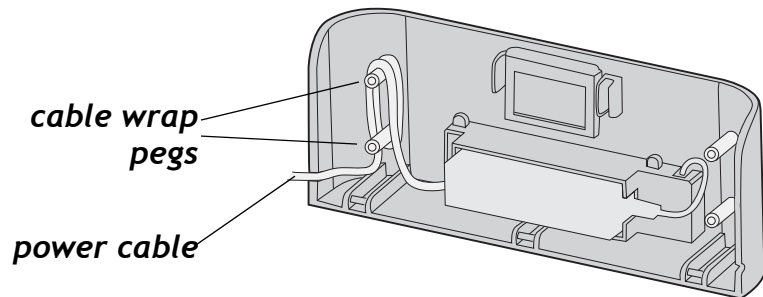

Charging base (internal view)

Important Safety Instructions

Please read all instructions before using this appliance.

Save these instructions for future reference.

Refer all non-routine servicing to Neato Robotics.

The robotic vacuum cleaner shall only be charged using the included charging base.

The robotic vacuum cleaner shall only be operated using the included batteries. Do not replace with non-rechargeable batteries.

This appliance is not intended for use by persons (including children) with reduced physical, sensory or mental capabilities, or lack of experience and knowledge, unless they have been given supervision or instruction concerning use of the appliance by a person responsible for their safety. Children should be supervised to ensure that they do not play with the appliance.

For best performance, empty your dirt bin and clean the vacuum's brush after each use.

Likes and Dislikes

There are just a few things to remember that will keep your Neato Vacuum happy and successful in your home:

Likes	Dislikes
<p>POWER. Charge it when you aren't using it to ensure that every time you need it, it will be ready to roll.</p>	<p>WATER, CHEMICALS, or OTHER MOLD PRODUCING FLUIDS. Do not clean wet messes with your Neato Vacuum. Though it may seem pet-like, do not bathe or otherwise submerge your Neato Vacuum in water. It also doesn't like harsh chemicals, or anything that can permanently stain it. It doesn't mind being cleaned and groomed with a damp cloth, however.</p>

Likes	Dislikes
<p>BOUNDARIES. Your Neato Vacuum likes to clean everywhere it can reach. If you want to keep the robot from a certain area, just put out the boundary markers (see page 41). The robot will clean up to the boundary markers but will not cross over the them.</p>	<p>HANGING CABLES AND LOW TO THE GROUND TABLECLOTHS. To keep your robot and your home safe, make sure that your vacuum cannot get caught on hanging electric cords, tablecloths, or other cord-like items.</p>
<p>GROOMING. Because it's down in the dirt all day long, your Neato Vacuum can get a little grungy. After a while, give it a once over to ensure wheels and brushes are free of hair and debris and to keep it running smoothly.</p>	<p>COLD. Exposing your Neato Robotics vacuum to freezing temperatures may cause permanent damage, and possibly hurt its feelings.</p> <p>OUTDOORS. Your Neato vacuum is a domestic device and not intended for outdoor use. Keep it in the house where it will be happy.</p>

Neato Vacuum cleaning smarts

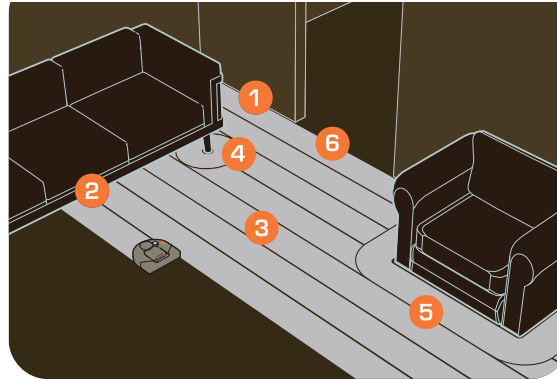

- 1- Rectangular front design allows vacuuming close to walls and into corners.***
- 2- Low profile allows cleaning under furniture.***
- 3- Always vacuums in straight lines.***
- 4 & 5- Cleans closely around obstacles.***
- 6- Automatic doorway recognition ensures complete cleaning of room before moving on to the next.***

Turn to Run Mode...

Remove dirt bin, and locate the **ON/OFF** switch.

Push the switch **DOWN** to turn your Neato to **ON**.

Replace the dirt bin.

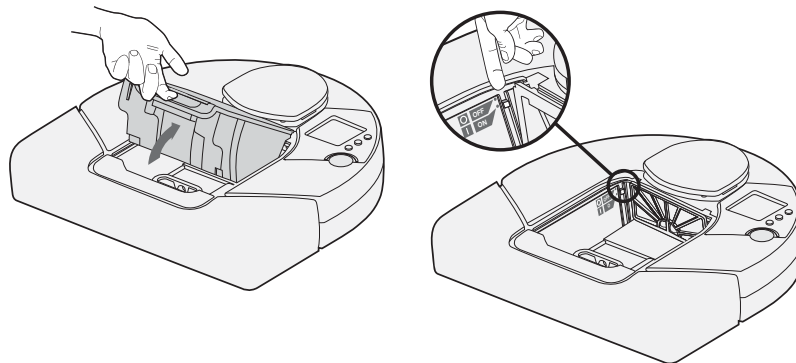

Using the Neato Vacuum

The Neato Vacuum is ready to start cleaning as soon as you charge up its battery.

- To charge the battery, see *Using the Charging Base* on page 16.
- To begin a quick-start cleaning, see *Quick-Start Your Robotic Vacuum* on page 22.
- To schedule regular cleanings, see *Scheduling a Cleaning* on page 30.

Using the Charging Base

The Neato Vacuum has a preinstalled rechargeable battery that has to be fully charged before you can use it for the first time.

To use the charging base, follow these steps:

- 1 Plug the charging base into the wall and place it on the floor in a room that you want to vacuum frequently and which provides the vacuum a clear path to return to recharge itself.
- 2 When placing the charging base, ensure that:
 - the back of the charging base is against a wall
 - the charging base is least 3 feet from a corner of the room
 - the charging base is not tilted

NOTE: There are exit holes on either side of the charging base so that you can have the cable exit the charging base on the side closest to the wall plug. Refer to the illustration on page 9.

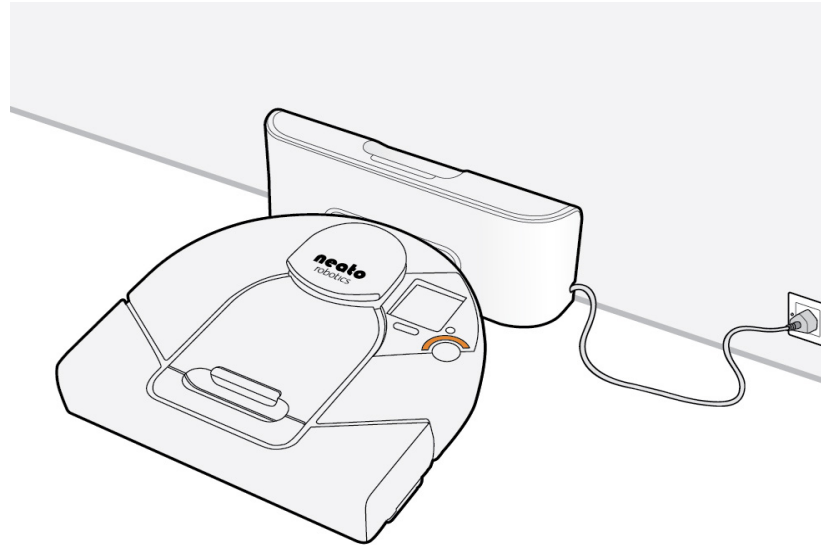

Connecting the Neato Vacuum to the charging base

Using the Charging Base

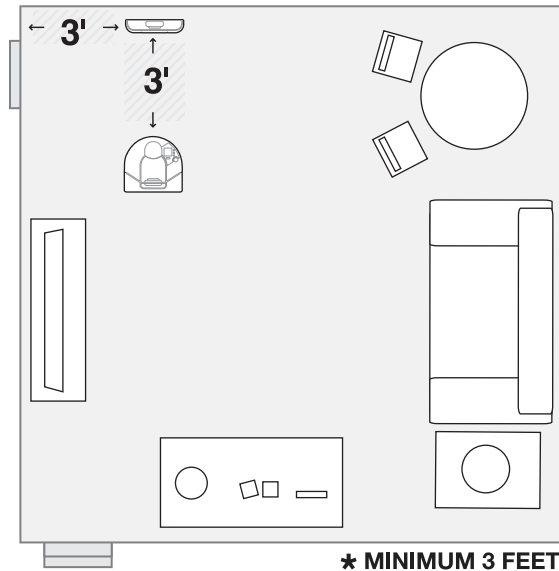

Giving the vacuum a clear path to its charger

- 3 Place the Neato Vacuum's curved edge up against the charging base so that the charging base's contact points make contact with the vacuum's charging contact points. The status light turns on to show you it is charging.

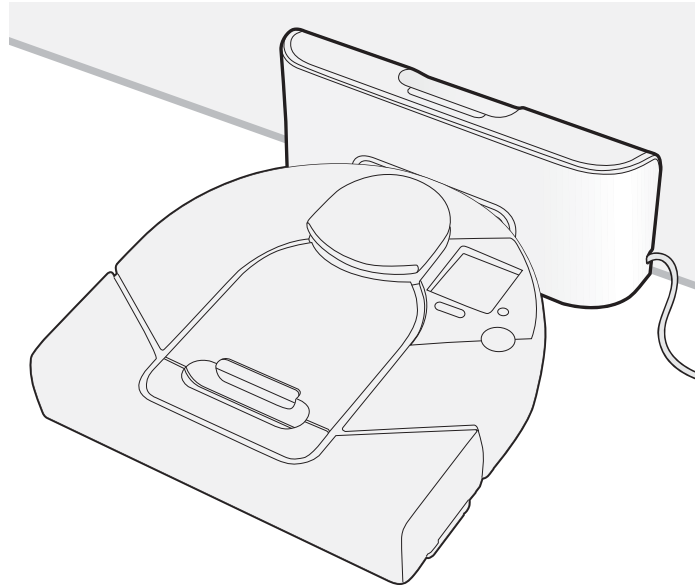

Neato Vacuum in its charging base

Charging Status

Charging Status

Recharging the battery takes about 2 to 3 hours. The status light lets you know the current charging state of your Neato Vacuum:

Status light color	Meaning
Solid green	Fully charged and ready to clean
Pulsing green	Charging, but ready to clean
Pulsing amber	Charging, can't clean yet
Solid amber	Vacuum has an error (see the LCD screen for details, and refer to <i>Communicating with Your Neato Vacuum</i> on page 42)

Optimal Charging

For optimal performance, we recommend that you charge your Neato Vacuum on the charging base whenever it is not cleaning. Not only will this make sure the vacuum will be ready for upcoming cleaning tasks, but it also ensures longer battery life.

Cleaning Mode

Your Neato cleans using its powerful vacuum. Just press the START button and it will vacuum your home, cleaning one room at a time. Neato creates a map of your home as it goes from room to room. When it needs to recharge its batteries, it uses the map to find its way back to where it started. Depending on where it started, it will:

START Connected to Charge Base: If Neato started at its charge base, it will return to the charge base to recharge, and after charging, go out and continue cleaning where it left off. If it still hasn't finished cleaning, it will return to its charge base once more, recharge, and return to finish cleaning where it left off.

START Not Connected to Charge Base: If Neato did not start at its charge base, it will go back to the location where it started, stop, and say please recharge my battery. When finished charging, place Neato within two feet of where it stopped and press START. It will return to where it left off to finish the cleaning job. This can be repeated one more time if it hasn't finished the cleaning job.

During a cleaning cycle Neato will do a maximum of three cleaning runs. When Neato finishes a cleaning cycle the map is erased.

Quick-Start Your Robotic Vacuum

The Neato Vacuum works best when it performs regularly scheduled cleanings (see *Scheduling a Cleaning* on page 30), but you can quick-start the vacuum for immediate cleaning any time.

To start the Neato Vacuum:

- 1 Charge the vacuum (see *Using the Charging Base* on page 16). When the **START** button light is solid green, the vacuum is fully charged.
- 2 Remove any loose items (such as small toy pieces) that might get caught in the vacuum's brushes.
- 3 Place your Neato Vacuum on the floor.
- 4 Press the **START** button. If the vacuum is asleep, that will wake it up! Then press the button once more to clean your entire house.

- 5 The Neato Vacuum maps the room and cleans it automatically.
- 6 When finished, the vacuum returns to where it started—either to the charging base or to where you manually started it in the room and turns itself off.

Using the Control Center LCD screen

The Neato Vacuum's LCD Control Center screen is your interface to communicate with the vacuum. This is where you give the vacuum its cleaning schedule or pause its cleaning cycle, and it's also where the vacuum will give you information. For example, it may tell you that it is returning to its base to recharge. In addition, if your vacuum encounters a problem, it will tell you what is happening so you can correct the problem.

The Welcome screen looks like this:



The button (called a soft key) below the screen performs the action shown above it on the screen (in this case, **MENU**, which opens the main menu).

Using this screen, you can:

- Clean a smaller area using Spot mode (see page 26)
- Set the clock of the Neato Vacuum (see page 28)
- Program the Neato Vacuum to clean on a scheduled basis (see page 30)
- Get feedback from the vacuum on how it is doing and where it might need some help (see page 42)
- Change the language on the LCD display (see page 36)
- Pause the vacuum (see page 37)
- Turn off the lights on the vacuum (see page 37)
- Turn off power to the vacuum (see page 38)
- Cancel cleaning (see page 37)
- Return the Neato Vacuum to its charging base (see page 37)
- Get support information for Customer Service

Using Spot Mode for Cleaning Smaller Areas

Using Spot Mode for Cleaning Smaller Areas

Spot Mode will clean a small area approximately 4 feet by 6 feet.

To use Spot Mode:

- 1** Place the Neato Vacuum on the ground, centered, and facing the area to be cleaned, and press MENU.



- 2** Press the arrow buttons to select **Spot Clean** and then press **SELECT**.



- 3** The Neato Vacuum cleans the 4' by 6' area in front of it: first the outline of the area, and then the interior.

(This page left intentionally blank.)

Setting the Clock

Setting the Clock

Before you can schedule future cleanings, you must set the current day and time on the vacuum so it knows when to start the next cleaning.

To set the date and time:

1 Press **MENU**.



2 Press the arrow buttons to select **Set Clock** and then press **SELECT**.



3 Use the arrow buttons to select either **12-Hour Clock** or **24-Hour Clock** and then press **SELECT**.

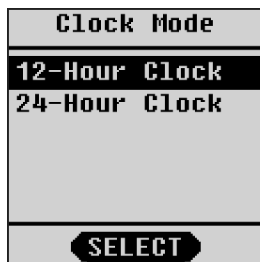

4 Use up and down arrows to select the current day of the week and press **ENTER**.

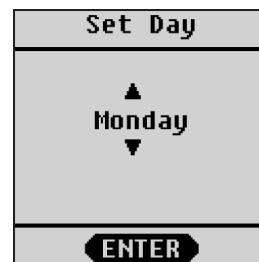

- 5** Use the arrow buttons to select the current hour and press **ENTER**. Cycle through the hours to select AM or PM.

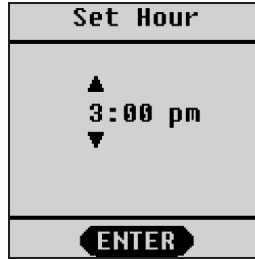

- 6** Use the arrow buttons to select the current minute and press **ENTER**.

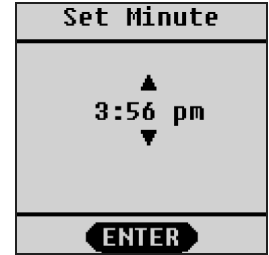

- 7** The current day and time are shown. Press the Back button  to make corrections; otherwise press **SAVE**.

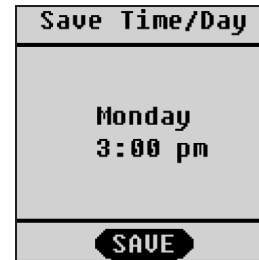

Scheduling a Cleaning

Scheduling a Cleaning

Before setting a schedule, set the clock as described in *Setting the Clock* on page 28.

To schedule a cleaning:

1 Press MENU.



2 Press the arrow buttons to select **Schedule** and then press **SELECT**.



3 Use the arrow buttons to select **Set or Change** and then press **SELECT**.

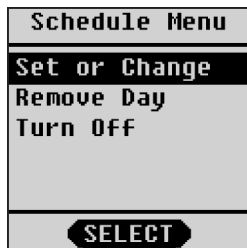

4 Use the arrow buttons to select the day you want your vacuum to clean and press **SELECT**.

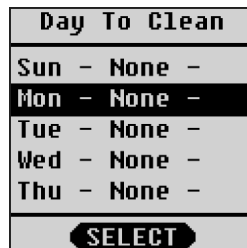

- 5** Use the arrow buttons to select the hour you want your vacuum to clean and then press **SELECT**.

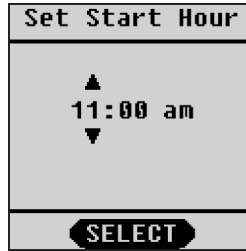

- 6** Use the arrow buttons to select the minute you want your vacuum to clean and then press **SELECT**.

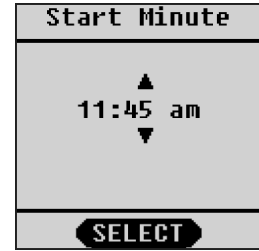

- 7** Confirm the day, time, and cleaning mode by pressing **ADD**. To make changes, press the Back button .

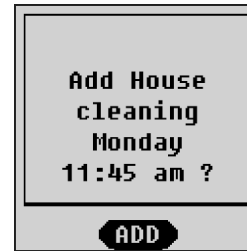

Future cleanings will occur at the times and dates you selected. At each scheduled time, the Neato Vacuum will come off of the charging base and start its scheduled cleaning. When finished cleaning, the vacuum returns to the charging base to recharge. If the battery runs low during the scheduled cleaning, the vacuum returns to its base, recharges, then returns one more time to clean where it left off.

To Get the Most of Scheduled Cleanings

If you are not using the charging base, you will need to put the Neato Vacuum out and it will start its scheduled cleaning when that is the actual time and day of the week. When you return, you will need to manually place the vacuum on its charging base.

To Get the Most of Scheduled Cleanings

- The charging base needs to be located within the area that you want to clean on a schedule.
- Make sure you empty the dirt bin (see *Emptying the Dirt Bin* on page 39) between scheduled cleanings for best results.
- If there is not enough battery power to complete the cleaning cycle, your Neato Vacuum returns to the charging base to recharge, and then will return to where it left off to finish its cleaning.

Ideas for Scheduled Cleanings

Some ways you can take advantage of scheduled cleanings include:

- Clean a specific high-traffic area on a regular basis. For example, you could set up a schedule to clean your kitchen and family room everyday at 10 a.m. Locating your charging base in the kitchen, the Neato Vacuum comes off its charging base, cleans the rooms, and returns to the charging base. Cleaning on an everyday basis helps to minimize dust build up and can result in a reduction in allergy symptoms.
- You could also have your charging base in your bedroom corridor and schedule it to clean every other day to keep your bedroom floors tidy. To keep the robot in that area of the house, just put out the Boundary Markers and then it will go out and clean as much as it can, return to charge, and then go back out to finish the cleaning where it left off if the area is large.

Removing a Scheduled Cleaning

If you need to remove a previously-scheduled cleaning, follow these steps.

1 Press MENU.



2 Press the arrow buttons to select Schedule and then press SELECT.



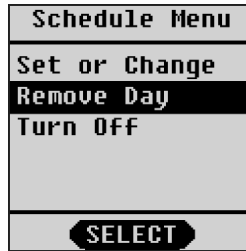

Removing a Scheduled Cleaning

- 3** Use the arrow buttons to select **Remove Day** and then press **SELECT**.

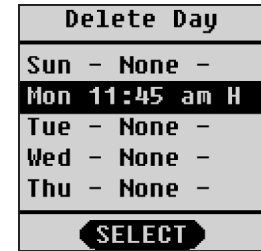

- 4** Use the arrow buttons to choose the cleaning event you want to remove and then press **SELECT**.



- 5** Press **DELETE** to confirm deletion. Use the Back button  if you made a mistake.

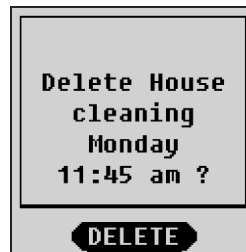

- 6** A confirmation message verifies the scheduled cleaning that you removed.

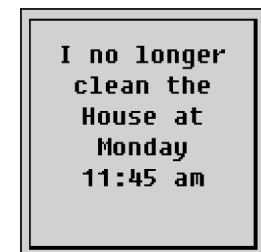

Changing the Language on the LCD Display

If you want to use a different language on the LCD display, follow these steps:

1 Press MENU.



2 Press the arrow buttons to select **Language** and then press **SELECT**.



3 Use the arrow buttons to select the language you want to use then press **SELECT**.



4 The LCD will now use the language you selected.

Pausing a Cleaning

If at any time you want to pause a cleaning, press any button on the Neato Vacuum and the vacuum will offer you a PAUSE menu. From the PAUSE menu, press the down arrows to make the vacuum:

- Pause its current cleaning
- Cancel its current cleaning
- Cancel and return to its charging base
- Resume its current cleaning

Use the up and down arrows and the SELECT button to tell your Neato Vacuum to do any of the above items.

Putting your Vacuum to Sleep

Press and hold the START button for 2 seconds and your Neato Vacuum's LCD screen light will go off. When the vacuum is turned on the next time, the lights will turn on again.

Turning off Your Vacuum

If you would like to turn off your vacuum for long term storage or if you are going away for vacation, you can turn off all power to your Neato Vacuum. Note that this will delete your clock settings.

To turn off your vacuum:

- 1 Select MENU from the LCD screen.
- 2 Select SUPPORT.
- 3 Select Shut Down.

To power your vacuum once you have done this, just press the START button and it will be fully powered again.

NOTE:Your Neato Vacuum cannot be on its charging base when you turn off all power to it.

NOTE:The robot will turn itself off automatically if the battery is extremely low. If your clock has been reset and the schedule is no longer available, it is because the battery became fully discharged. This is why we recommend that you keep the robot charging at all times when not in use for cleaning.

Emptying the Dirt Bin

For optimal performance, empty the Neato Vacuum's dirt bin after every use.

- 1 Remove the dirt bin.

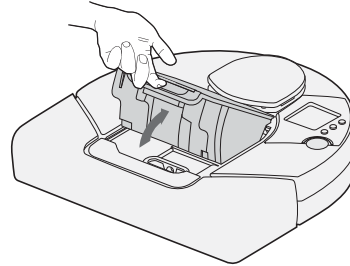

- 2 Remove the filter.

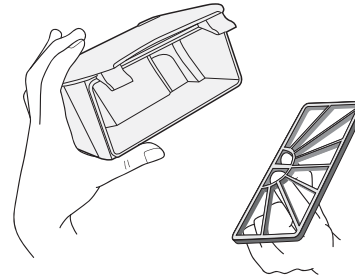

Emptying the Dirt Bin

- 3** Empty the contents of the dirt bin into a garbage can. Tap the filter against the garbage can to get rid of any excess dirt.

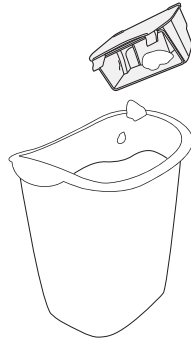

- 4** Replace the filter cover, then replace the dirt bin into the top of the Neato Vacuum.

Boundary Markers

Boundary Markers are useful tools that tell your Neato Vacuum where *not* to clean.

Boundary markers are most helpful when you want to:

- Create a boundary where one does not exist. You might have a large open plan house where you want to clean a subset of a large room like the shaded area shown here.
- Keep your Neato Vacuum away from any item that you don't want the vacuum to get near.

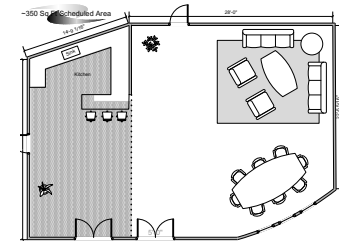

Using boundary markers

To use the markers, simply lay the boundary marker flat on the floor from one wall to the opposite wall to block off an area. The Neato Vacuum will clean the floor on the side of the boundary marker that it is started on. Place the vacuum within the bounded area and press START. The vacuum recognizes the boundary markers and will not cross them. You can use scissors to cut a shorter length of the boundary markers if needed.

When finished, the vacuum returns to its charging base or to where it started if it cannot find its base. (In this case, you need to start charging the vacuum as soon as you can.)

Communicating with Your Neato Vacuum

Communication is a two-way street, so be sure to listen when your Neato Vacuum is talking to you!

When it's charging, the status light around the START button will be GREEN to indicate your Neato Vacuum is ready for work.

If the status light is AMBER, the Neato Vacuum needs some assistance before going to work. Just read the LCD control center screen to see what your vacuum needs assistance with. The vacuum will tell you when to:

- Empty its dirt bin and filter
- Fix its stuck brush
- Unstick its bumper
- Clean its drop sensor windows

...and other feedback too.

Getting the Best Performance from Your Neato Vacuum

- 1 Empty your Dirt Bin after every cleaning
- 2 Clean your brush of debris frequently
- 3 Periodically dust off your drop sensors. Using a cotton swab, clean the two drop sensor windows on the bottom of your Neato Vacuum, located as shown below.

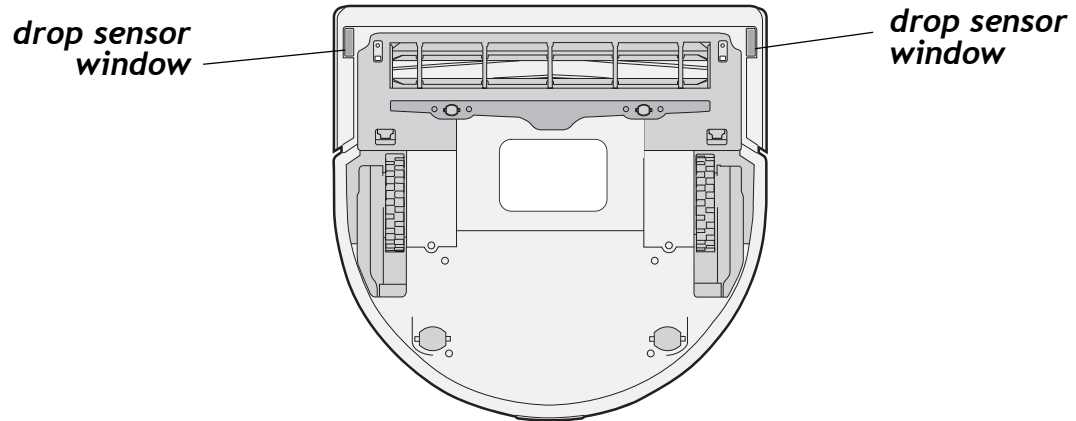

Cleaning the drop sensors

LCD Feedback Messages

Your vacuum is smart and will let you know when it needs help with anything. Just read the messages on the LCD to understand what it needs. Here are some specific tips.

LCD Message	Remedy
Dirt Bin Full	Empty dirt bin and replace into its slot.
Brush Stuck	Remove brush guard and clean all hair and debris from brush and brush shaft. Replace brush and guard and press START button to resume cleaning.
Bumper Stuck	Jiggle the bumper to loosen.
Time Not Set	If your battery runs very low, the Neato Vacuum loses its clock setting. Use the menus to reset the time and day as described in <i>Setting the Clock</i> on page 28.

LCD Message	Remedy
Cannot Charge	Make sure the charging cable is plugged into the base and wall. When vacuum is initially connected to the base, the status light will light up to let you know the power is on.

LCD Feedback Messages

LCD Message	Remedy
Vacuum Won't Dock	<p>If your vacuum is having difficulty docking on its charging base, ensure that:</p> <ul style="list-style-type: none">• the charging base is located at least 3 feet from a corner of a room• the charging base has clearance 3 feet in front of it• the charging base is not hidden behind a couch or other furniture• the charging base is solid against a wall and is not leaning backward or forward• if charging base is on carpet, try relocating to a hard floor surface <p>If you still have difficulties, please contact Neato Customer Care.</p>

Filters

To get the best results, we recommend emptying your dirt bin and cleaning the filter after every vacuum session as described in *Emptying the Dirt Bin* on page 39. To clean your filter, just tap the filter against a garbage can to loosen the debris off of it.

We also recommend changing your filter in your vacuum every one to two months (based on typical usage; if you use your vacuum more frequently, you may need to change your filter more often.)

(This page intentionally left blank.)

Customer Support

If you have any questions or comments,

- Contact your authorized reseller or
- Visit www.NeatoRobotics.com for additional information.

Limited Warranty

See Limited Warranty at www.neatorobotics.com.

Compliance Information

Room Positioning System: RPS Infrared Laser Distance Sensor

This Laser Product is designated as Class 1 during all procedures of operation.

Human Accessible Laser Parameters:

- Wavelength 785 nm
- Pulse Rep Frequency 1.8 kHz
- Pulse Duration 200 μ sec
- Peak Power 2.1 mW
- Beam Diameter 2.3 mm
- Beam Divergence -1.5 mrad

Caution: Use of controls or adjustments or performance of procedures other than those specified herein may result in hazardous radiation exposure.

Neato Robotics, Inc.
8100 Jarvis Avenue Suite 100
Newark, CA 94560

No service is allowed by the user. If there are any problems with the RPS laser distance sensor, the robot should be returned to an authorized service provider for service or repair.

Declaration of Conformity

We declare under our sole responsibility that the,

Robotic Vacuum Cleaner Model: XV Series and derivatives

to which this declaration relates, is in conformity with the following standards,

Council Directive 2006/95/EC – Low Voltage Directive

EN60335-1: 2002 + A1+ A2 +A11 +A12 +A13

IEC/ EN 60335-2-2:2003 + A1 + A2

EN 50366:2003 + A1

The last two digits of the year in which the CE marking was affixed are 10.

Council Directive 2004/108/EC – Electro Magnetic Compatibility Directive

EN55014-1:1997 w/ A1: 2001, and A2:2001, Class B,

EN 55014-2:1997

EN 61000-3-2: 2006 (AC Charger)

EN 61000-3-3: 2008 (AC Charger)

All technical documentation required to demonstrate that the products meet the requirement of the Low Voltage Equipment Directive has been compiled and is available for inspection by the relevant enforcement authorities. Details of these special measures and limitations to use are available upon request. The CE mark was first applied in 2010 and re-issued in 2012 due to new product variants.

April 2012

Date of Issue
Neato Robotics
Newark, CA
USA



FCC COMPLIANCE STATEMENT

This device complies with part 15 of the FCC rules. Operation is subject to the following two conditions:

- 1 this device may not cause harmful interference, and
- 2 this device must accept any interference received, including interference that may cause undesired operation

NOTE: This equipment has been tested and found to comply with the limits for a Class B digital device, pursuant to part 15 of the FCC Rules. These limits are designed to provide reasonable protection against harmful interference in a residential installation. This equipment generates, uses and can radiate radio frequency energy and, if not installed and used in accordance with the instructions, may cause harmful interference to radio communications. However, there is no guarantee that interference will not occur in a particular installation. If this equipment does cause harmful interference to radio or television reception, which can be determined by turning the equipment off and on, the user is encouraged to try to correct the interference by one or more of the following measures:

- Reorient or relocate the receiving antenna.
- Increase the separation between the equipment and receiver.
- Connect the equipment into an outlet on a circuit different from that to which the receiver is connected.
- Consult the dealer or an experienced radio/TV technician for help.



Trade Name: NEATO
Model Number: XV Series
Responsible Party: NEATO Robotics

Changes or modifications not expressly approved by Neato can void the user's authority to operate the equipment.

Disposal Notices

Neato Vacuum

If you ever dispose of your Neato Vacuum, follow these steps:

- 1 Unplug the Neato Vacuum from any power source, including removing it from its charging base and removing the power adapter plug from the Neato Vacuum power connector.
- 2 Unscrew the battery doors (shown in the bottom view illustration on page 8) and unplug and remove the batteries.
- 3 Take the vacuum to the nearest waste management electronics recycling center.
- 4 Take the batteries to a battery recycling program at your school, place of work, or your nearest waste management battery recycling center.

Batteries

If the batteries leak due to overheating or physical abuse, place them in a plastic bag and dispose of them in accordance with all applicable federal, state, and local regulations. Following battery removal, the battery compartments in the Neato Vacuum should be wiped with a damp cloth and allowed to dry before installing new batteries.

Linux Operating System

Some Neato products incorporate and rely upon the Linux operating system. Linux is licensed to the public under version 2 of the [GNU General Public License](http://www.gnu.org/licenses/gpl-2.0.html) (“GPLv2”), a copy of which is available at <http://www.gnu.org/licenses/gpl-2.0.html>. Neato has made modifications to Linux to improve the operating system’s functionality on Neato products. The source code for the Linux operating system, including Neato’s modifications, is available for download at <http://www.neatorobotics.com/lab/linux>.

Notwithstanding anything to the contrary in the Neato EULA, Linux installations included with Neato products and available for download from the Neato website are governed by the terms of the GPLv2. To the extent that any of the terms and conditions of the Neato EULA conflict with the GPLv2, such conflicting terms of the Neato EULA do not apply to the Linux installations. The licensors of the Linux operating system disclaim all warranties and liability, whether express or implied, relating to or resulting from use or distribution of the Linux operating system. Please consult the GPLv2 for additional licensing information relating to Linux.

NOTE: The Neato application, which provides functionality specific to the Neato products, such as the LCD menu and the robot’s navigation intelligence, is proprietary software developed by Neato Robotics, Inc. The Neato application has not been combined or distributed with the Linux operating system in a manner that would obligate Neato to license the application under the terms of

the GPLv2. Use of the Neato application is governed by the applicable Neato EULA (<http://www.neatorobotics.com/EULA>). For clarity, Neato has not placed the Neato application in the public domain, nor has Neato licensed the application under the terms GPLv2.

NOTE: If you are unable or unwilling to download our modifications from <http://www.neatorobotics.com/lab/linux>, you may instead request to receive a CD-R with our modifications. To do so, please send a written request to:

Neato Robotics, Inc.
Attention: Customer Care - GNU/Linux Source Code Request.
8100 Jarvis Ave. Suite 100
Newark, CA 94560

Please include a check in the amount of \$15.00 to cover reproduction, shipping, and handling costs. Please allow 3 weeks for shipping once we receive your request.

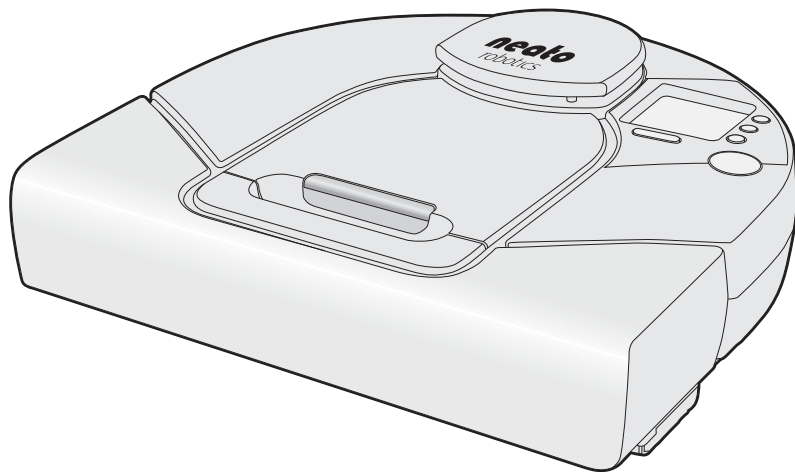

Neato XV™ 系列机器人吸尘器 用户指南

使用此装置前请阅读所有说明。

保存好这些说明。

有关附加的安全说明，请参阅第 10 页。



Neato Robotics, Inc.
8100 Jarvis Avenue Suite 100
Newark, CA 94560

版权所有 © 2013 Neato Robotics, Inc.。保留所有权利。

Neato Robotics 是 Neato Robotics, Inc. 的注册商标。

目录

欢迎！	5
Neato 机器人吸尘器剖析图	6
重要安全说明	10
要做的和不要做的	11
切换至运行模式	14
使用 Neato 机器人吸尘器	15
使用充电基座	16
充电状态	20
最佳充电	20
清扫模式	21
快速启动您的机器人吸尘器	22
使用控制中心 LCD 屏幕	24
使用定点模式清扫更小的区域	26
设置时钟	28
定时预约清扫	30
要充分利用定时预约清扫	32

定时预约清扫的想法	33
移除定时预约清扫	34
更改 LCD 显示屏上的语言	36
暂停清扫	37
将机器人吸尘器切换到睡眠模式	37
关闭机器人吸尘器	38
清空尘盒	39
边界标记	41
使用边界标记	41
与您的 Neato 机器人吸尘器沟通	42
获得 Neato 机器人吸尘器的最佳性能	43
LCD 反馈消息	44
过滤器	46

客户支持 49

有限保修	50
符合性信息	51
符合性声明	52
FCC 符合性声明	54
处置注意事项	56
Neato 机器人吸尘器	56
电池	56
Linux 操作系统	57

欢迎！

感谢您购买新的 Neato 机器人吸尘器。欢迎步入家用机器人革命。

此内容详细的用户指南将提供您需要知道的所有信息。简单易行。

如果您时间不宽裕，想立即了解基础使用方法，您可以阅读《快速入门指南》。更加简便。

我们希望与您保持联系。

为保证您及时获取有关您的新 Neato 机器人吸尘器的最新信息，请在以下网址进行产品注册：
<http://www.neatorobotics.com>。

Neato 专注于研发家用机器人产品，旨在将每一位用户从枯燥的家庭清扫中解放出来。

Neato 机器人吸尘器剖析图

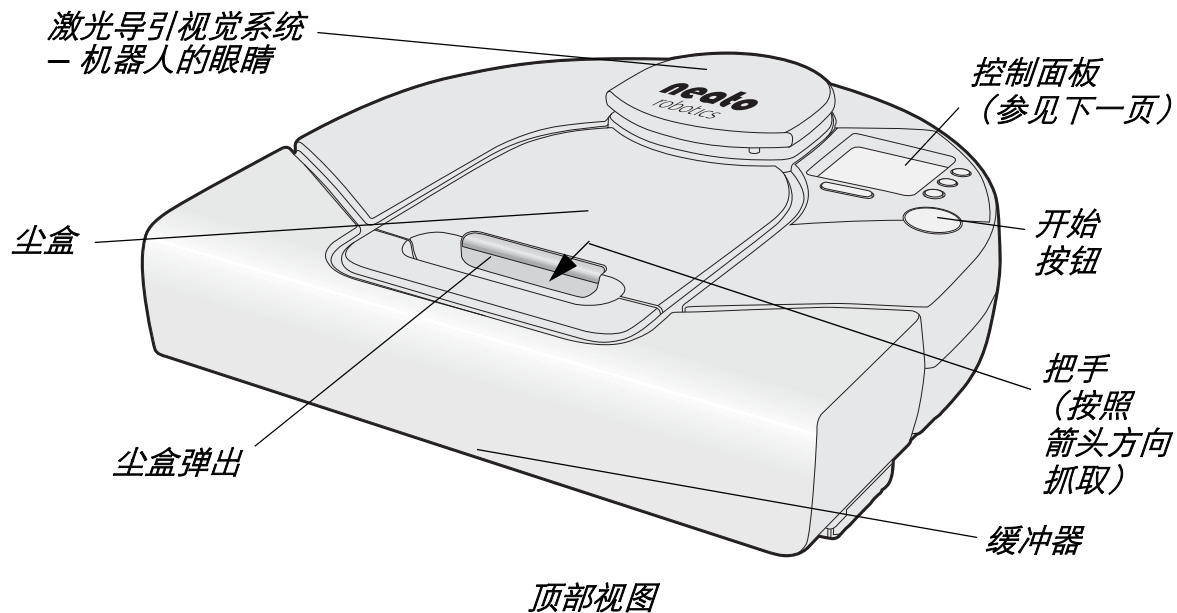

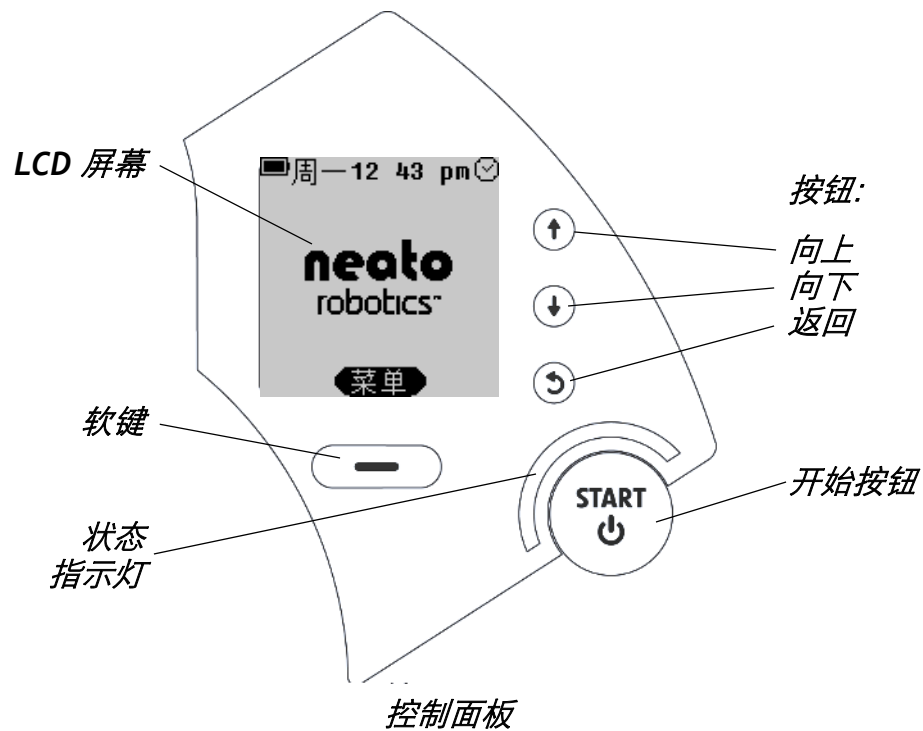

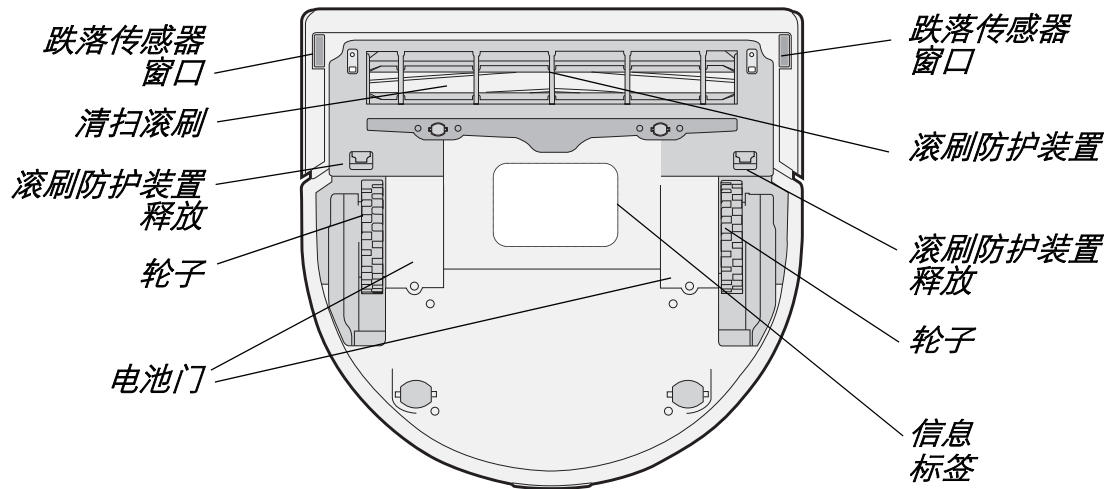

底部视图

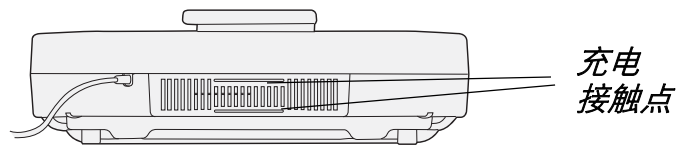

背面视图

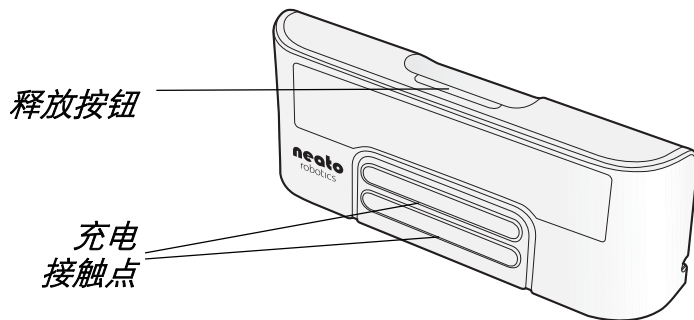

释放按钮

充电
接触点

充电基座（外部视图）

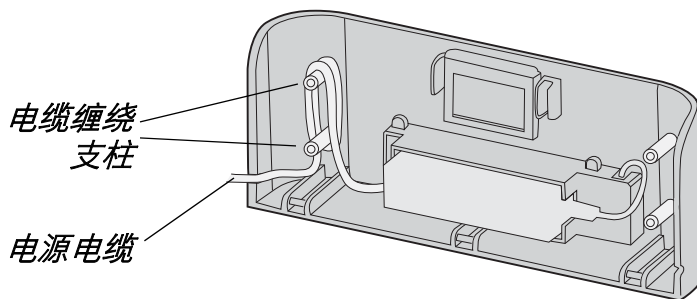

电缆缠绕
支柱

电源电缆

充电基座（内部视图）

重要安全说明

使用此装置前请阅读所有说明。

保存好这些说明，以备今后参考。

对于所有非例行维修，请委托 **Neato Robotics** 执行。

本机器人吸尘器仅可使用随附的充电基座进行充电。

本机器人吸尘器仅可使用随附的电池进行操作。请勿使用非充电电池来代替。

身体、感官或心理残疾或缺乏经验和知识的人士（包括儿童）不得使用此装置，除非在其监护人的监管或指导下使用。确保儿童不将此装置当做玩具。

为确保最佳性能，请在每次使用后清空尘盒并清扫吸尘滚刷。

要做的和不要做的

为确保 Neato 机器人吸尘器更好地在您家中提供服务，有一些事项您需要记住：

要做的	不要做的
<p>电源。不使用机器人时，请对其进行充电，以确保在您每次使用时，它都电量十足。</p>	<p>水、化学品或其它液体。请勿用 Neato 机器人吸尘器清理湿垃圾。虽然 Neato 机器人吸尘器看起来像宠物，但是请勿对其进行冲洗，或将其浸入水中。此外，请勿让其接触刺激性化学品或任何染色剂。但，您可使用湿抹布对其进行擦洗。</p>

要做的	不要做的
<p>边界。Neato 机器人吸尘器能够清扫任何它可以到达的地方。如果您不想让机器人打扫某一区域，您只需放置边界标记即可（参见第 41 页）。机器人将会清扫到边界标记，但不会越过边界标记。</p>	<p>悬挂的电缆和贴近地面的桌布。为确保机器人和您家庭的安全，确保悬挂的电线、桌布和其它类似电线的物件不会绊住您的机器人吸尘器。</p>
<p>清理。由于 Neato 机器人吸尘器整天与脏东西打交道，它会变得有点脏。用过一段时间后，请粗略查看一下它，确保轮子和滚刷上没有毛发和碎屑，使其能够顺畅地运行。</p>	<p>低温。将 Neato 机器人吸尘器放置在零度以下环境中可能会对其造成永久损害，很可能损伤它的感知能力。</p> <p>室外。Neato 机器人吸尘器是家用电器，不可在室外使用。请将其放于室内使用。</p>

Neato 机器人吸尘器智能清扫

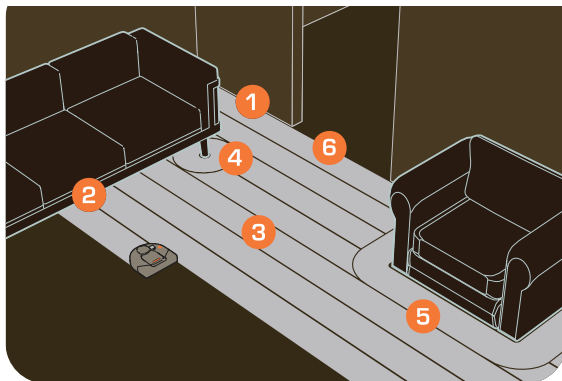

- 1- 矩形前端设计使其可以贴近墙面和墙角吸尘打扫。
- 2- 低矮的外形使其可以在家具下面开展清扫工作。
- 3- 始终以直线路径吸尘打扫。
- 4 & 5- 紧贴障碍物环绕清扫。
- 6- 自动门口识别确保在移动到下一单房间前，完成对单房间的全面清扫。

切换至运行模式 ...

取出尘盒，找到“打开”/“关闭”开关。

向下推开关将 Neato 打开。

装回尘盒。

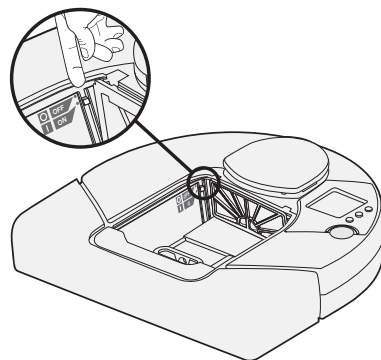
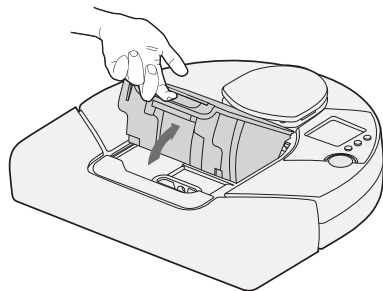

使用 Neato 机器人吸尘器

电池充满电后，Neato 机器人吸尘器便可以开始清扫。

- 要给电池充电，请参阅第 16 页的 *使用充电基座*。
- 要快速启动清扫，请参阅第 22 页的 *快速启动您的机器人吸尘器*。
- 要定时预约清扫，请参阅第 30 页的 *定时预约清扫*。

使用充电基座

Neato 机器人吸尘器预安装了一块充电电池，首次使用前，您必须将其充满电。

要使用充电基座，请遵循以下步骤：

- 1 将充电基座插入墙上的壁装插座，并将其放在您想要经常吸尘打扫的单房间的地板上，以提供一条明确的路径给机器人吸尘器返回充电基座进行充电。
- 2 放置充电基座时，请确保：
 - 充电基座背面贴紧墙面
 - 充电基座与单房间的墙角距离至少保持 3 英尺
 - 充电基座不倾斜

注意：充电基座两侧各有一个出口孔，您可以在距墙上插头最近的一侧，将电缆从充电基座拉出。参考第 9 页的图例。

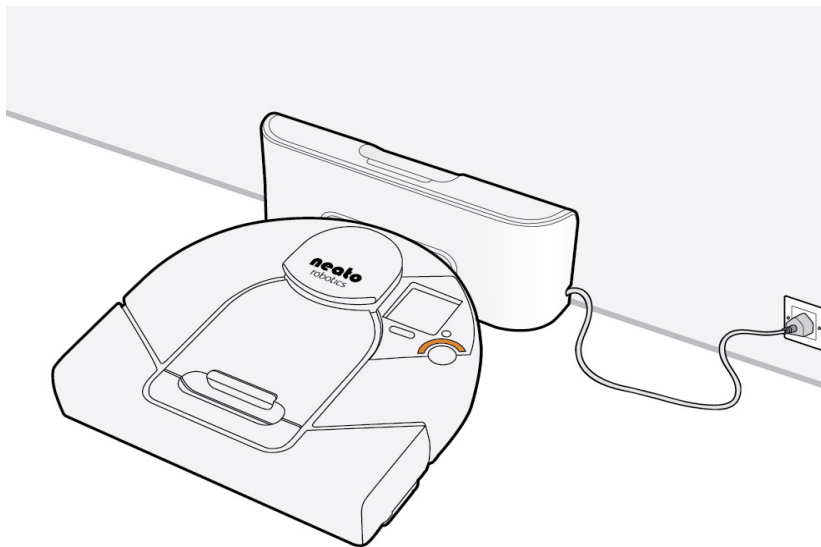

将 Neato 机器人吸尘器连接至充电基座

使用充电基座

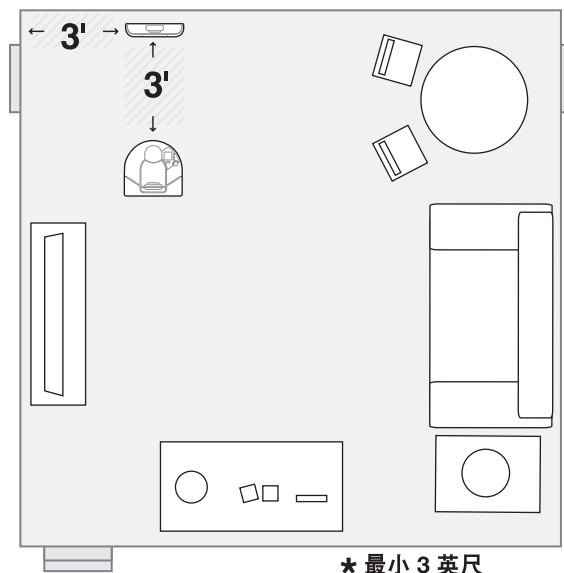

给机器人吸尘器一条到其充电器的明确路径

- 3 将 Neato 机器人吸尘器的弯曲边缘顶在充电基座上，使充电基座的接触点与机器人吸尘器的充电接触点接触。状态指示灯亮起，表明正在充电。

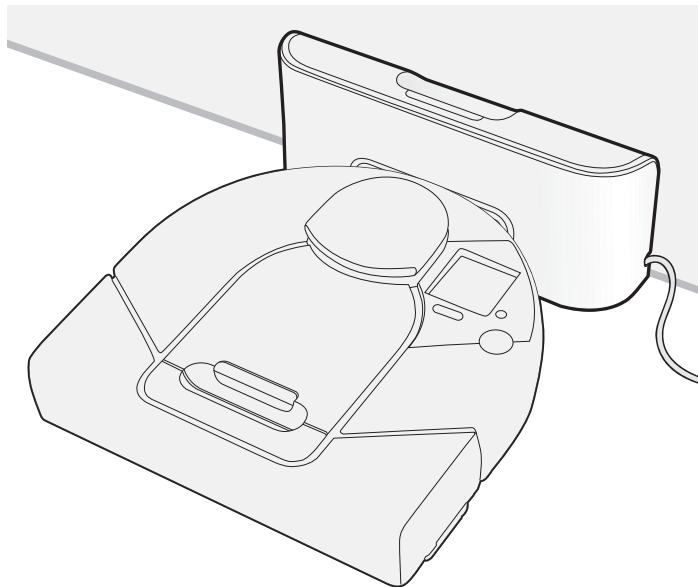

Neato 机器人吸尘器在充电基座上

充电状态

电池充电需要大约 2 到 3 小时。状态指示灯向您指示 Neato 机器人吸尘器当前的充电状态：

状态指示灯颜色	含义
常亮绿色	充满电，准备清扫
闪烁绿色	正在充电，但可以开始清扫
闪烁琥珀色	正在充电，但尚不能清扫
常亮琥珀色	机器人出现错误（参阅 LCD 屏幕了解详情，参考第 42 页的与您的 <i>Neato</i> 机器人吸尘器沟通）

最佳充电

为确保获得最佳性能，建议在不使用 Neato 机器人吸尘器时，将其放在充电基座上充电。这不仅可以确保机器人吸尘器为即将到来的清扫任务做好准备，还可以确保更长的电池使用寿命。

清扫模式

Neato 机器人使用其强大的真空吸尘器进行清扫。只需按开始按钮，它便开始逐个打扫您的房间。Neato 在逐房间打扫时会创建一个房间地图。当它需要充电时，它将使用该地图返回开始处。根据其开始位置，它将：

从充电基座开始：如果 Neato 从充电基座开始打扫，电池电量快耗尽时，它将返回充电基座充电，充满电后，回到暂停处继续打扫。如果仍未完成清扫工作，它将再次返回充电基座充电，然后返回暂停处完成清扫。

不从充电基座开始：如果 Neato 不从充电基座开始打扫，电池电量快耗尽时，它将返回开始打扫处，停下并发出充电请求。完成充电后，请将 Neato 放在其停止处周围两英尺以内，然后按开始按钮。它将返回暂停打扫处完成清扫工作。如果未完成清扫工作，它将重复此操作。

在一个清扫周期中，Neato 最多可如此循环三次。完成清扫周期后，Neato 将删除地图。

快速启动您的机器人吸尘器

当执行定时预约清扫时，Neato 机器人吸尘器工作效率最佳（参阅第 30 页的*定时预约清扫*），但是您可以随时快速启动机器人吸尘器，立即开始清扫。

要启动 Neato 机器人吸尘器：

- 1 给机器人吸尘器充电（参阅第 16 页的*使用充电基座*）。当“开始”按钮指示灯常亮绿色时，表明机器人吸尘器已充满电。
- 2 拿开所有可能卡在机器人吸尘器滚刷上的松散物件（如小玩具配件）。
- 3 将 Neato 机器人吸尘器放在地板上。
- 4 按“开始”按钮。如果机器人吸尘器处于睡眠模式，此操作可将其唤醒！然后再按一次该按钮，开始清扫整个多房间。

- 5 Neato 机器人吸尘器会将单房间地图保存起来，自动进行清扫。
- 6 完成后，机器人吸尘器返回到起始位置（充电基座或您在单房间内手动启动它的地方），然后自动关闭。

使用控制中心 LCD 屏幕

Neato 机器人吸尘器 LCD 控制中心屏幕是您与机器人吸尘器沟通的界面。这是您为机器人吸尘器提供清扫定时预约或暂停其清扫周期的界面，也是机器人吸尘器为您提供信息的界面。例如，它可以告诉您，它即将返回充电基座充电。此外，如果机器人吸尘器出现问题，它会告诉您所发生状况，以便您解决问题。

“欢迎”屏幕看起来如下：



屏幕下方的按钮（亦称软键）用于执行屏幕上它上方所显示的操作（在本例中，“菜单”用于打开主菜单）。

使用此屏幕，您可以：

- 使用“定点”模式清扫更小的区域（参阅第 26 页）
- 设置 Neato 机器人吸尘器的时钟（参阅第 28 页）
- 为 Neato 机器人吸尘器编程以进行定时预约清扫（参阅第 30 页）
- 从机器人吸尘器获取与其运行状况和所需帮助相关的反馈信息（参阅第 42 页）
- 更改 LCD 显示屏上的语言（参阅第 36 页）
- 暂停机器人吸尘器（参阅第 37 页）
- 关闭机器人吸尘器上的指示灯（参阅第 37 页）
- 关闭机器人吸尘器的电源（参阅第 38 页）
- 取消清扫（参阅第 37 页）
- 将 Neato 机器人吸尘器返回充电基座（参阅第 37 页）
- 获取客户服务支持信息

使用定点模式清扫更小的区域

使用定点模式清扫更小的区域

在定点模式中，将清扫约 4 英尺 × 6 英尺的小区域。

要使用定点模式：

- 1 将 Neato 机器人吸尘器居中放在地面上，面向即将清扫的区域，按“菜单”。



- 2 按箭头按钮选择“定点清扫”，然后按“选择”。

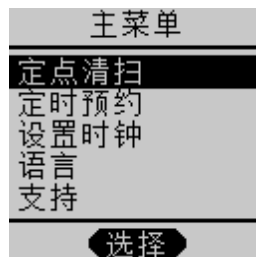

- 3 Neato 机器人吸尘器将清扫其前方 4 英尺 × 6 英尺的区域：首先清扫区域外围，然后清扫内部。

(本页故意留为空白。)

设置时钟

在您可以定时预约将来的清扫前，您必须在机器人吸尘器上设置当前日期和时间，以便其知晓何时进行下一清扫。

要设置日期和时间：

1 按“菜单”。



2 按箭头按钮选择“设置时钟”，然后按“选择”。

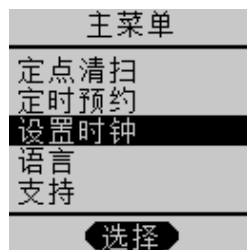

3 使用箭头按钮选择“12 小时制”或“24 小时制”，然后按“选择”。

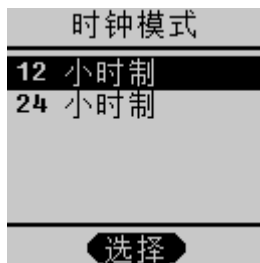

4 使用向上和向下箭头选择星期几，然后按“确定”。



- 5** 使用箭头按钮选择当前小时，然后按“确定”。循环小时选择“上午”或“下午”。



- 6** 使用箭头按钮选择当前分钟，然后按“确定”。



- 7** 当前日期和时间已经显示。按“返回”按钮  进行更正；否则按“保存”。

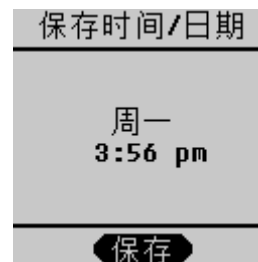

定时预约清扫

设置定时预约前，请按第 28 页的*设置时钟*中所述设置时钟。

要定时预约清扫：

1 按“菜单”。



2 按箭头按钮选择“定时预约”，然后按“选择”。

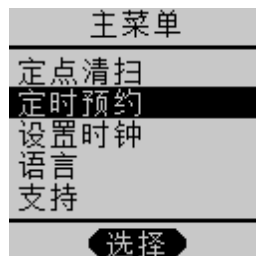

3 按箭头按钮选择“修改定时预约”，然后按“选择”。

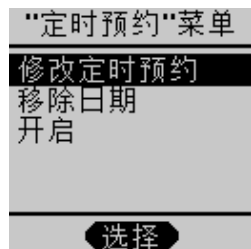

4 使用箭头按钮选择您想要机器人吸尘器开展清扫工作的日期，然后按“选择”。

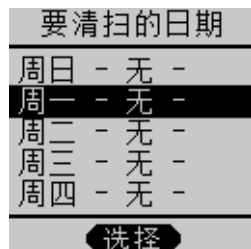

- 5** 使用箭头按钮选择您想要机器人吸尘器开展清扫工作的小时，然后按“选择”。

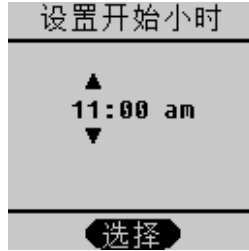

- 6** 使用箭头按钮选择您想要机器人吸尘器开展清扫工作的分钟，然后按“选择”。

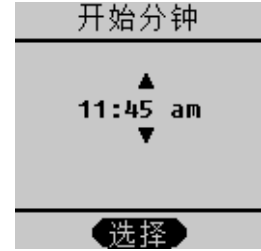

- 7** 通过按“添加”确认日期、时间和清扫模式。要进行更改，请按“返回”按钮 。

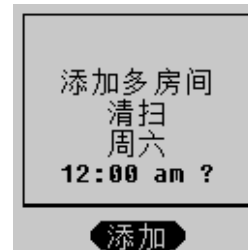

将会在您选定的时间和日期进行将来的打扫。在每一个定时预约时间，Neato 机器人吸尘器将离开充电基座，开始定时预约清扫。完成清扫后，机器人吸尘器自动返回充电基座充电。如果在预约清扫期间，电池电量快耗尽，机器人吸尘器将自动返回充电基座充电，然后再回到暂停处继续未完成的清扫。

要充分利用定时预约清扫

如果您未使用充电基座，您需要手动启动 Neato 机器人吸尘器。它将根据实际的时间和星期几开始定时预约清扫。您回来后，需要手动将机器人吸尘器放回充电基座。

要充分利用定时预约清扫

- 需要将充电基座放在您想要进行定时预约清扫的区域内。
- 确保在定时预约之间清空尘盒（参阅第 39 页的 *清空尘盒*）以获得最佳结果。
- 如果电池电量不足以完成清扫周期，Neato 机器人吸尘器将自动返回充电基座充电，然后回到暂停处继续完成清扫。

定时预约清扫的想法

一些帮助您利用定时预约清扫的方式：

- 定期清扫经常走动的特定区域。例如，您可以设置一个定时预约在每天上午 10 点清扫您的厨房或客厅。将充电基座放在厨房内，Neato 机器人吸尘器会自动离开充电基座，清扫单房间，然后返回充电基座。每天定时清扫有助于降低灰尘堆积，减少过敏症状。
- 您还可以将充电基座放在卧室走廊上，定时预约每隔一天清扫一次卧室地板。要使机器人保持在多房间的该区域内，只需放置边界标记即可，然后机器人便可以出去进行尽可能多的清扫，如果清扫区域较大，在电池电量快耗尽时，它将返回充电基座充电，然后回到暂停处继续清扫。

移除定时预约清扫

如果您需要移除之前设置的定时预约清扫，请遵循以下步骤：

1 按“菜单”。



2 按箭头按钮选择“定时预约”，然后按“选择”。

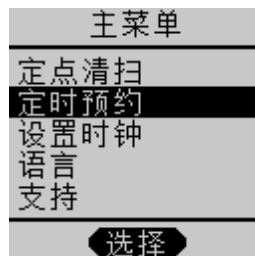

- 3** 使用箭头按钮选择“移除日期”，然后按“选择”。

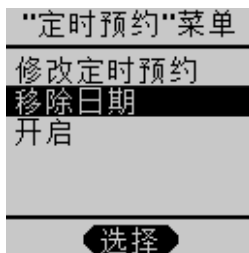

- 4** 使用箭头按钮选择您要移除的清扫事务，然后按“选择”。

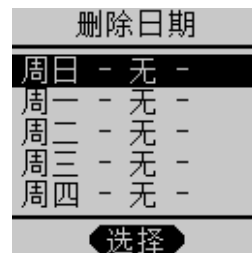

- 5** 按“删除”确认删除。如果操作失误，请使用“返回”按钮 。

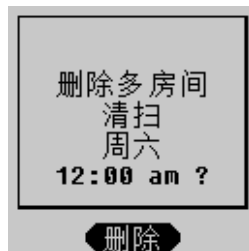

- 6** 将显示一条确认消息核实您移除的定时预约清扫。

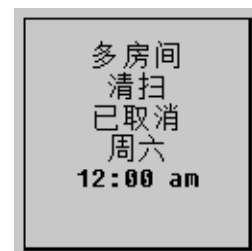

更改 LCD 显示屏上的语言

如果您要在 LCD 显示屏上使用不同的语言，请遵循以下步骤：

1 按“菜单”。



2 按箭头按钮选择“语言”，然后按“选择”。

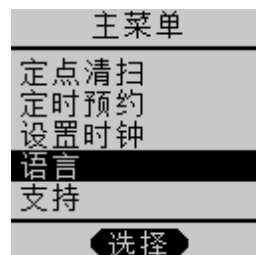

3 使用箭头按钮选择您想要使用的语言，然后按“选择”。



4 LCD 将使用您选择的语言。

暂停清扫

在任何时间如果您想要暂停清扫，请按 **Neato** 机器人吸尘器上的任一按钮，机器人吸尘器将显示“暂停”菜单。从“暂停”菜单中，按向下箭头使机器人吸尘器：

- 暂停当前清扫
- 取消当前清扫
- 取消清扫，并返回充电基座
- 恢复当前清扫

使用向上和向下箭头以及“选择”按钮告诉 **Neato** 机器人吸尘器执行以上任一命令。

将机器人吸尘器切换到睡眠模式

按“开始”按钮并保持 2 秒钟，**Neato** 机器人吸尘器 LCD 屏幕指示灯将熄灭。下次打开机器人吸尘器时，指示灯将再次亮起。

关闭机器人吸尘器

如果要关闭机器人吸尘器以长期存放，或者如果您要外出度假，您可以关闭 Neato 机器人吸尘器的所有电源。注意这将删除您的时钟设置。

要关闭机器人吸尘器：

- 1 选择 LCD 屏幕上的“菜单”。
- 2 选择“支持”。
- 3 选择“关机”。

要在完成此操作后重新启动机器人吸尘器，只需按“开始”按钮即可。

注意：关闭 Neato 机器人吸尘器的所有电源后，不可将它放在充电基座上。

注意：如果电池电量过低，机器人将自动关闭。如果时钟已被重新设置，定时预约不再可用，这是因为电池电量已完全耗尽。因此，我们建议您在机器人不进行清扫时，始终将其保持在充电状态。

清空尘盒

为确保获得最佳性能，请在每次使用后，清空 Neato 机器人吸尘器的尘盒。

1 取出尘盒。

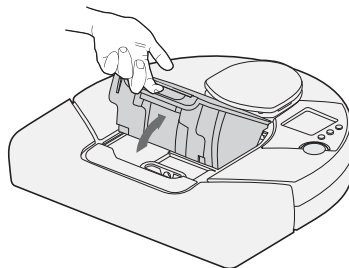

2 取下过滤器。

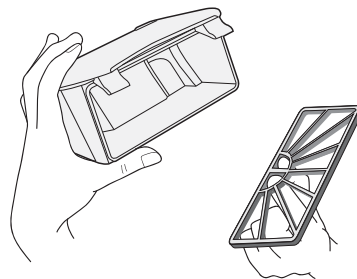

清空尘盒

- 3** 将尘盒内垃圾清空倒入垃圾箱。对着垃圾箱轻敲过滤器，清除剩余的灰尘。

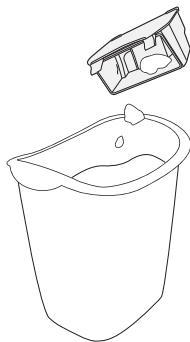

- 4** 将过滤器放回过滤器盖中，然后将尘盒装回 Neato 机器人吸尘器的顶部。

边界标记

边界标记是告诉 Neato 机器人吸尘器什么地方不用清扫的有用工具。

当您想做如下事情时，边界标记是非常有用的：

- 在不存在边界的地方创建一个边界。您可能拥有一个大的开放式规划多房间，想要清扫一个大单房间中的一部分区域，如此处显示的阴影部分。
- 让 Neato 机器人吸尘器远离您不想让其接近的任何物件。

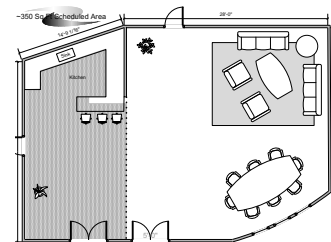

使用边界标记

要使用边界标记，只需将它紧贴地板从一面墙拉到对面墙，即可封锁一个区域。Neato 机器人吸尘器将会在其启动的边界标记的一侧清扫地板。将机器人吸尘器放在边界标记限定的区域内，然后按“开始”。机器人吸尘器将识别边界标记，且不会越过边界标记。您可按照需要使用剪刀将边界标记剪成更短的长度。

完成清扫后，机器人吸尘器将返回充电基座，如果未找到充电基座，将返回到起始位置。（在这种情况下，您需要尽快给机器人吸尘器充电。）

与您的 Neato 机器人吸尘器沟通

沟通是相互的，在 Neato 机器人吸尘器跟您讲话时，请认真听。

充电时，“开始”按钮周围的状态指示灯将变为绿色，指示 Neato 机器人吸尘器可以工作。

如果状态指示灯为琥珀色，则表明 Neato 机器人吸尘器在开始工作前需要获得一些帮助。只需要阅读 LCD 控制中心屏幕显示的内容，了解机器人吸尘器需要什么帮助。机器人吸尘器将告诉您何时：

- 清空尘盒和过滤器
- 修复卡住的滚刷
- 扯开缓冲器
- 清洁跌落传感器窗口

...以及其它反馈信息。

获得 Neato 机器人吸尘器的最佳性能

- 1 每次清扫后，清空尘盒
- 2 经常清理粘在滚刷上的碎屑
- 3 定期除净跌落传感器的灰尘。使用棉签清洁 Neato 机器人吸尘器底部的两个跌落传感器窗口（位置如下所示）。

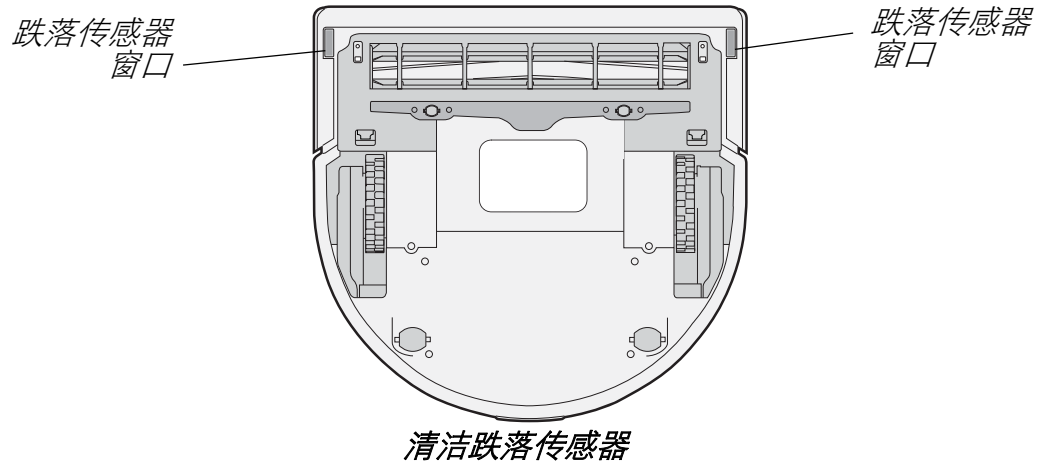

LCD 反馈消息

机器人吸尘器是智能的，在其需要任何帮助时，会让您知道。只需阅读 LCD 上的消息，便可了解它需求什么。以下是一些特定的提示。

LCD 消息	解决方法
尘盒已满	清空尘盒，然后将其装回插槽中。
滚刷卡住	卸下滚刷防护装置，清除滚刷和滚刷轴上的所有毛发和碎屑。装回滚刷和防护装置，按“开始”按钮继续清扫。
缓冲器卡住	轻摇缓冲器使其松开。
未设置时间	如果电池电量非常低，Neato 机器人吸尘器将失去它的时钟设置。使用菜单重新设置时间和日期，如第 28 页的 <i>设置时钟</i> 中所描述。

LCD 消息	解决方法
无法充电	确保充电电缆插入基座和墙上的壁装插座。首次将机器人吸尘器与基座连接时，状态指示灯将亮起，指示电源已打开。
机器人吸尘器无法对接	<p>如果很难将机器人吸尘器与充电基座对接，请确保：</p> <ul style="list-style-type: none">• 充电基座与单房间的墙角距离至少保持 3 英尺• 充电基座前方有 3 英尺空隙• 充电基座没有被沙发或其它家具挡住• 充电基座稳固依靠在墙上，没有前后倾斜• 如果充电基座位于地毯上，尝试将其重新放置在硬地板上 <p>如果您仍有问题，请联系 Neato 客户关怀。</p>

过滤器

要获得最佳结果，我们建议您在每次吸尘打扫后，清空尘盒和清洁过滤器，如第 39 页的 *清空尘盒* 中所述。要清洁过滤器，只需对着垃圾箱轻敲过滤器，敲掉上面的碎屑即可。

我们也建议您每一到两个月更换一次机器人吸尘器中的过滤器（基于典型使用情况；如果您使用机器人吸尘器较频繁，则您可能需要更频繁地更换过滤器。）

(本页故意留为空白。)

客户支持

如果有任何问题或意见，

- 请**联系**您的授权转售商或
- 访问 www.NeatoRobotics.com 了解附加信息。

有限保修

请访问我们的网站 www.neatorobotics.com，查看有限保修条款。

符合性信息

单房间定位系统：RPS 红外线激光测距传感器

该激光产品在所有操作程序中被定义为 1 级。

人类可用的激光参数：

- 波长 785 nm
- 脉冲重复频率 1.8 kHz
- 脉冲持续时间 200 s
- 峰值功率 2.1 mW
- 光束直径 2.3 mm
- 光束发散度 -1.5 mrad

小心：未按照此处规定的参数控制、调整或执行产品程序可能引起危险的辐射暴露。

Neato Robotics, Inc.
8100 Jarvis Avenue Suite 100
Newark, CA 94560

不允许用户进行维修。如果 RPS 激光测距传感器出现任何问题，应将机器人返回到授权服务提供商处维修或修理。

符合性声明

我们负责任地声明，

机器人吸尘器 型号：XV 系列及派生产品

符合以下标准：

理事会指令 2006/95/EC 低电压指令

EN60335-1: 2002 + A1+ A2 +A11 +A12 +A13

IEC/ EN 60335-2-2:2003 + A1 + A2

EN 50366:2003 + A1

附加 CE 标记的年份的后两位数是 10。

理事会指令 2004/108/EC 电磁兼容性指令

EN55014-1:1997 w/ A1:2001 和 A2:2001, B 类

EN 55014-2:1997

EN 61000-3-2: 2006 (交流充电器)

EN 61000-3-3: 2008 (交流充电器)

所有表明产品符合低电压设备指令要求的技术文档均已编写完成，可供相关执法机构随时检查。可应请求提供这些特殊措施和使用限制的详细信息。我们于 2010 年首次采用 CE 标记，2012 年由于发布新产品型号，我们重新获得 CE 标记认证。

2012 年 4 月

颁发日期
Neato Robotics
Newark, CA
USA



FCC 符合性声明

本设备符合 FCC 规则第 15 部分的要求。操作须符合以下两种条件：

- 1 本设备不可造成有害干扰，
- 2 本设备必须接受任何已接收到的干扰，包括可能导致意外操作的干扰

注意： 本设备经测试证实，符合 FCC 规则第 15 部分对 B 类数字设备的限制。这些限制用于在住宅安装环境下针对有害干扰提供适当的保护。本设备产生、使用且可能辐射射频能量，如果不按照说明安装和使用，可能会对无线电通信造成有害干扰。但是，我们不能担保干扰不会在特定安装环境中出现。如果本设备对无线电或电视接收造成有害干扰（可通过打开和关闭本设备进行判断），用户可尝试遵照以下一项或多项措施校正干扰：

- 重新定向或重新放置接收天线。
- 增大设备和接收器之间的距离。
- 将设备连接到与接收器所连接电路不同的插座上。
- 咨询经销商或有经验的无线电/电视技术人员，寻求帮助。



商品名称：NEATO

型号：XV 系列

责任方：NEATO Robotics

未经 Neato 明确许可而变更或改装本设备可导致用户操作设备的授权失效。

处置注意事项

Neato 机器人吸尘器

如果您要处置 Neato 机器人吸尘器，请遵循以下步骤：

- 1 将 Neato 机器人吸尘器从电源上拔下，同时将其从充电基座上取下，并从 Neato 机器人吸尘器电源连接器卸下电源适配器插头。
- 2 打开电池门（参见第 8 页底部视图），取出电池。
- 3 将机器人吸尘器拿到最近的废品管理电子产品回收中心。
- 4 将电池拿到您学校、工作地点或最近的废品管理电池回收中心。

电池

如果电池由于过热或损坏而导致泄漏，请将其装入塑料袋中，并按照所有适用的联邦、州和地方法规进行处置。取出电池后，Neato 机器人吸尘器中的电池盒需用湿抹布擦干净，并等晾干后再安装新电池。

Linux 操作系统

一些 Neato 产品整合并依托 Linux 操作系统。Linux 在第 2 版 [GNU 通用公共许可证 \(GPLv2\)](http://www.gnu.org/licenses/gpl-2.0.html) 中已向公众开放，您可在 <http://www.gnu.org/licenses/gpl-2.0.html> 下载副本。Neato 对 Linux 进行了一些修改，以改善 Neato 产品上的操作系统功能性。对于 Linux 操作系统（包括 Neatos 修改版）的源代码，您可在 <http://www.neatorobotics.com/lab/linux> 下载。

如 Neato EULA 中无另行说明，则 Neato 产品中包含的且可从 Neato 网站下载的 Linux 安装受 GPLv2 条款约束。如果 Neato EULA 的任何条款和条件与 GPLv2 冲突，Neato EULA 的这些冲突条款将不适用于 Linux 安装。Linux 操作系统的许可方否认任何因使用或分发 Linux 操作系统而导致的或与其相关的担保和责任，无论是明示或暗示的。请查阅 GPLv2 了解与 Linux 相关的附加许可信息。

注意：为 Neato 产品提供专用功能的 Neato 应用程序，如 LCD 菜单和机器人导航智能，是 Neato Robotics, Inc. 开发的专有软件。Neato 应用程序与 Linux 操作系统整合或分发的方式不能致使 Neato 按照 GPLv2 中的条款发放应用程序许可证。Neato 应用程序的使用受适用的 Neato EULA (<http://www.neatorobotics.com/EULA>) 约束。为清楚起见，Neato 未开放 Neato 应用程序，或按照 GPLv2 中的条款发放应用程序许可证。

注意：如果您无法或不愿意从 <http://www.neatorobotics.com/lab/linux> 下载我们的修改版，您可申请获得一份包含修改版的 CD-R。如需这样做，请将书面申请寄送至：

Neato Robotics, Inc.
Attention: Customer Care - GNU/Linux Source Code Request.
8100 Jarvis Ave. Suite 100
Newark, CA 94560

请附上面值 15 美元的支票，用以支付复制、运送和处理费用。我们将在接到申请后 3 周内交货。