

Atlas - Internal Cube

Assembly Instructions - Please keep for future reference

339/5176

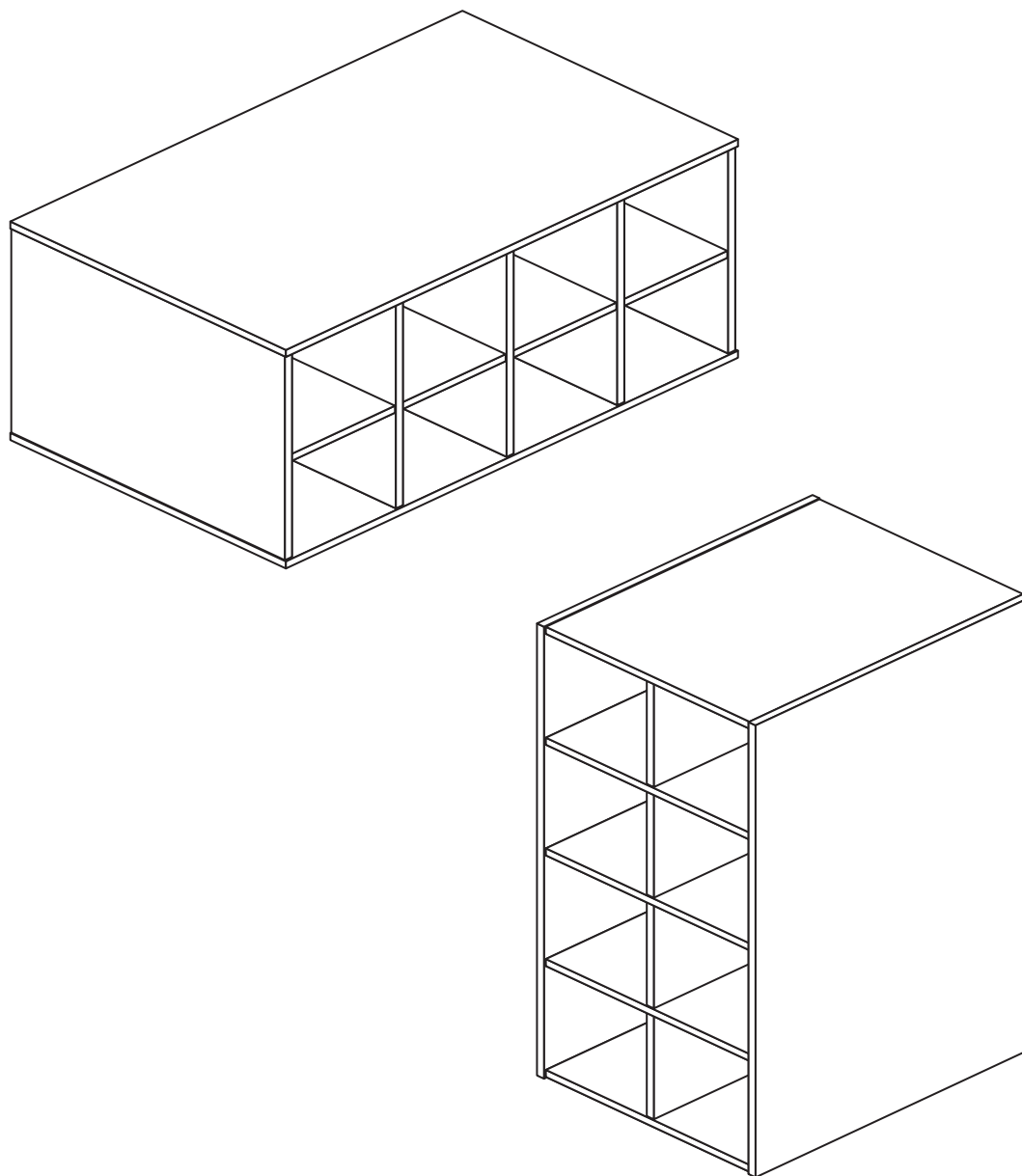

Low Unit Dimensions

Width - 97cm

Depth - 59cm

Height - 47cm

Tall Unit Dimensions

Width - 47cm

Depth - 59cm

Height - 97cm



**MADE IN
BRITAIN**

Important - Please read these instructions fully before starting assembly

If you need help or have damaged or missing parts, call the **Customer Helpline: 08456 400800**



Safety and Care Advice

Important - Please read these instructions fully before starting assembly

- **Warning:** This unit weighs approximately 30kgs. Please lift with care.

- Check you have all the components and tools listed on pages 2 and 3.

- Remove all fittings from the plastic bags and separate them into their groups.

- Keep children and animals away from the work area, small parts could choke if swallowed.

- Parts of the assembly will be easier with 2 people.

- Make sure you have enough space to layout the parts before starting.

- Do not stand or put weight on the product, this could cause damage.

- Assemble the item as close to its final position (in the same room) as possible.

- Assemble on a soft level surface to avoid damaging the unit or your floor (use opened out unit carton).



- We do not recommend the use of power drill/drivers **for inserting screws**, as this could damage the unit. Only use hand screwdrivers.

- **Safety note:** If there is any chance of this unit being pulled over by children etc. it is recommended that the unit is secured to a wall using suitable fixings (not supplied).

- Dispose of all packaging carefully and responsibly.

Care and maintenance

- Only clean using a damp cloth and mild detergent, do not use bleach or abrasive cleaners.

- From time to time check that there are no loose screws on this unit.

- This product should not be discarded with household waste. Take to your local authority waste disposal centre.

Note: If required the next page can be cut out and used as reference throughout the assembly. Keep this page with these instructions for future reference.

Components - Panels

If you have damaged or missing components, call the **Customer Helpline: 08456 400800** quoting the reference numbers below

Please check you have all the panels listed below

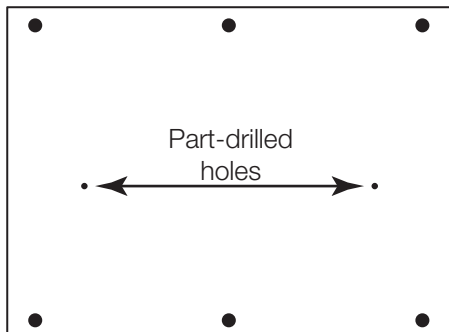

1 Side (DF1809)
(438 x 586mm)

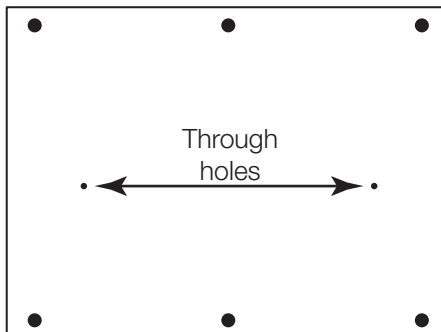

2 Divider (DF1810)
(438 x 586mm) x 4

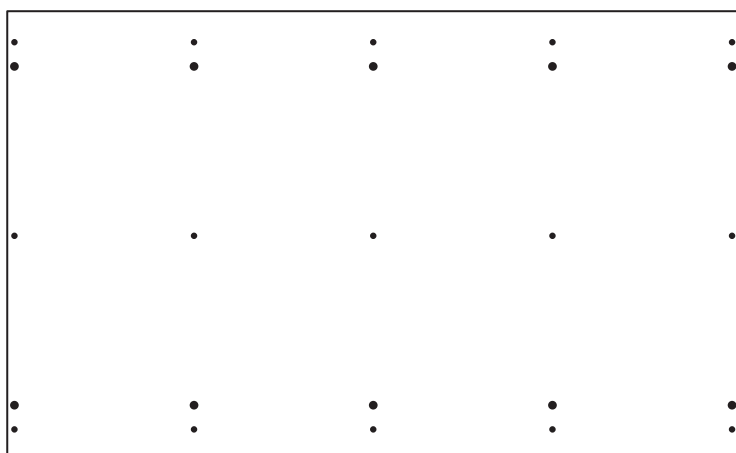

3 Top/Base (DF1808)
(968 x 590mm) x 2

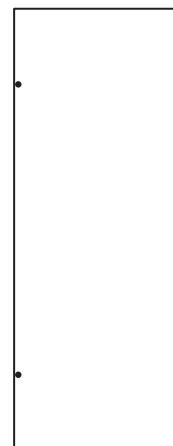

4 Shelf (DF1811)
(222 x 584mm) x 4



Components - Fittings

If you have damaged or missing components, call the **Customer Helpline: 08456 400800** quoting the reference numbers below

Please check you have all the fittings listed below

Note: The quantities below are the correct amount to complete the assembly. In some cases more fittings may be supplied than are required.

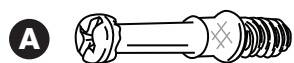

Metal dowel (F901) x 30



Large locking nut (F900) x 30



Wooden dowel (F22) x 20

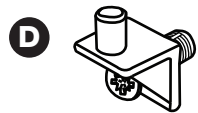

Shelf stud (F372) x 16

Tools required

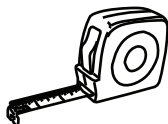

Rule



Cross-head screwdriver



Scissors



Hammer



Eye protection (when using a hammer or drill)

Ruler - Use this ruler to help correctly identify the screws

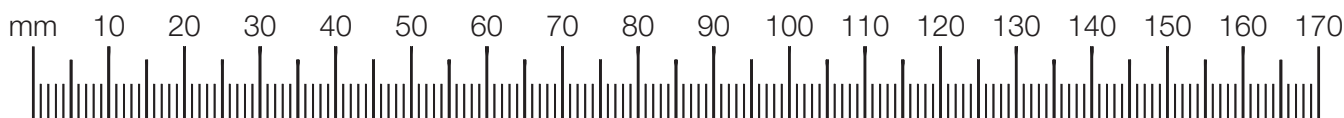

Assembly Instructions

If you have damaged or missing components, call the
Customer Helpline: 08456 400800 quoting the reference
numbers below

Step 1

Prepare the side and the 4 dividers

Insert 6 large locking nuts **B** into the side **1** and each of the 4 dividers **2**.

Note: The arrow on the locking nut **must** point towards the hole in the edge of the panel.

Tap 4 wooden dowels **C** into the side **1** and each of the 4 dividers **2**.

Note: Wooden dowels **must not** stick out from the edge by more than 10mm or they may damage other panels.

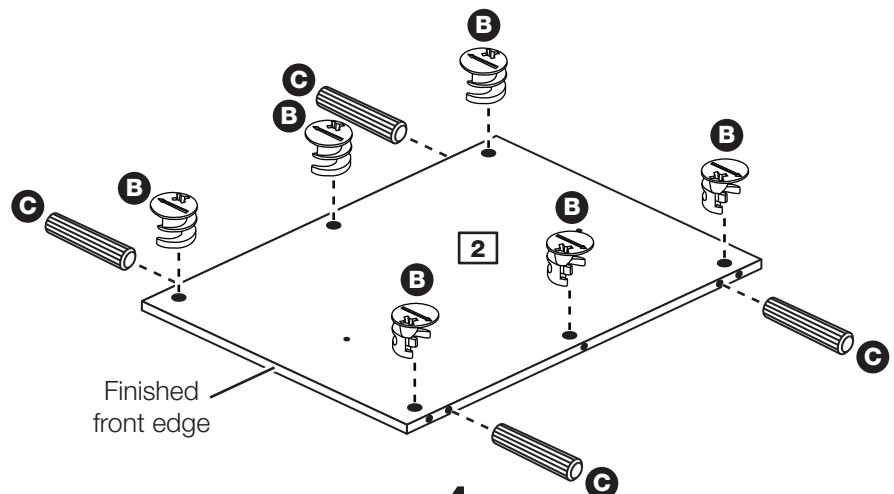
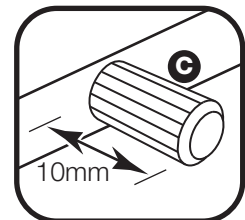
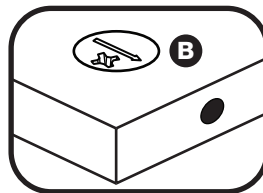
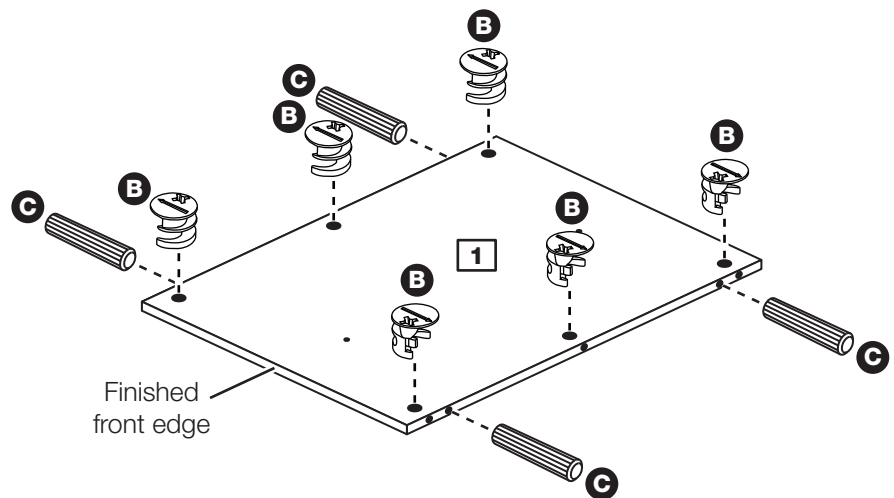

x 4

Assembly Instructions

Step 2

Prepare the top and base

Screw 15 metal dowels **A** into the top and base **3**.

Note: Tighten the metal dowels up fully against the panels.

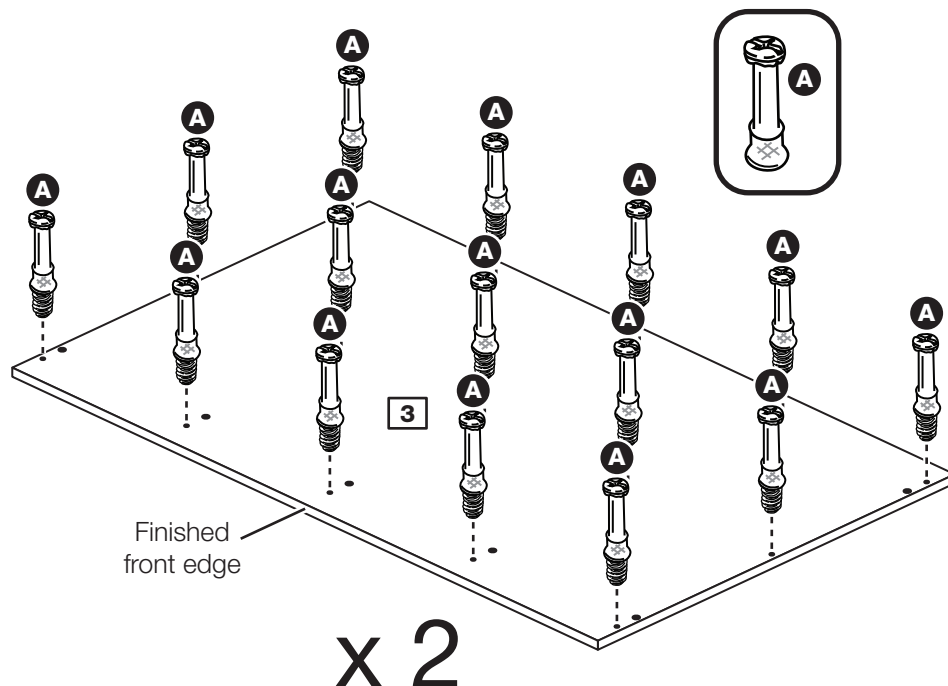

Step 3

Fit the side to the base

Push the side **1** onto the base **3**.

Use a screwdriver to tighten the 3 large locking nuts **B** fitted to the side **1**.

Note: Turn the large locking nuts **B** as far as they will go - more than 1/2 a turn.

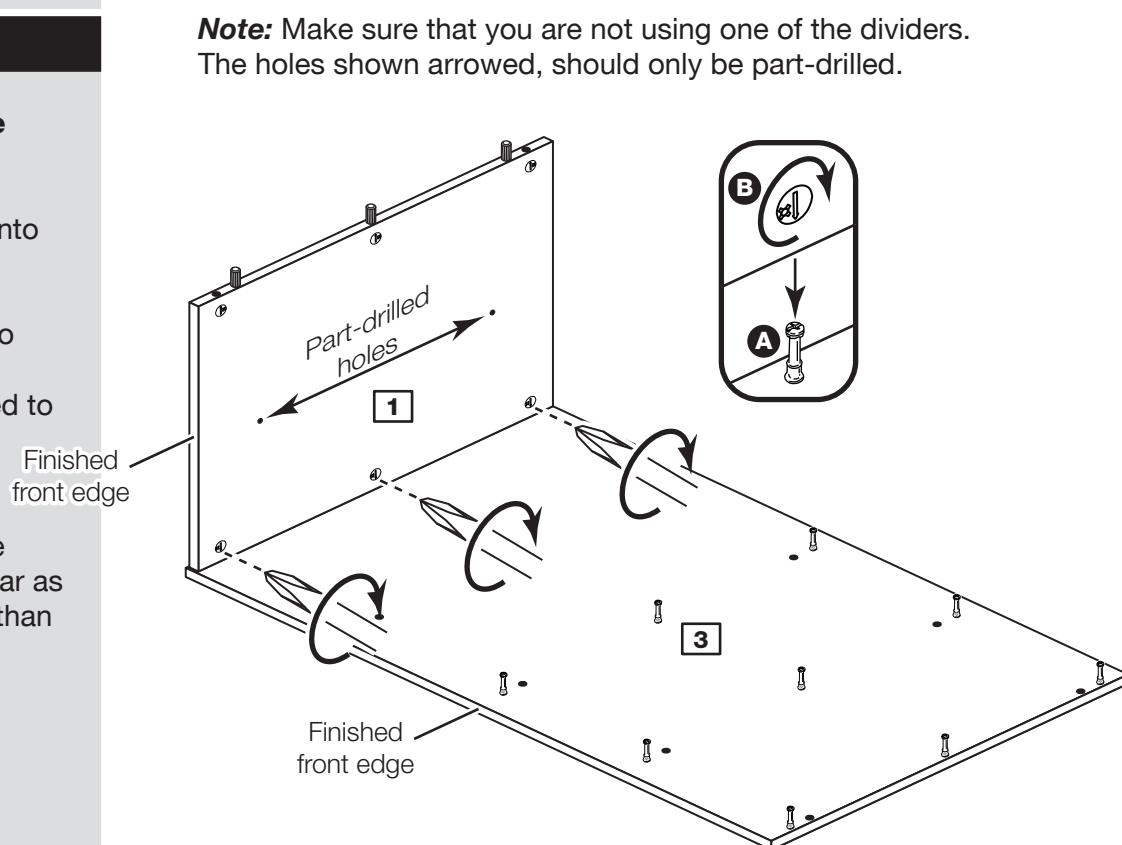

Assembly Instructions

Step 4

Fit the 4 dividers to the base

Push the 4 dividers **2** onto the base **3**.

Use a screwdriver to tighten the 3 large locking nuts **B** fitted to each of the 4 dividers **2**.

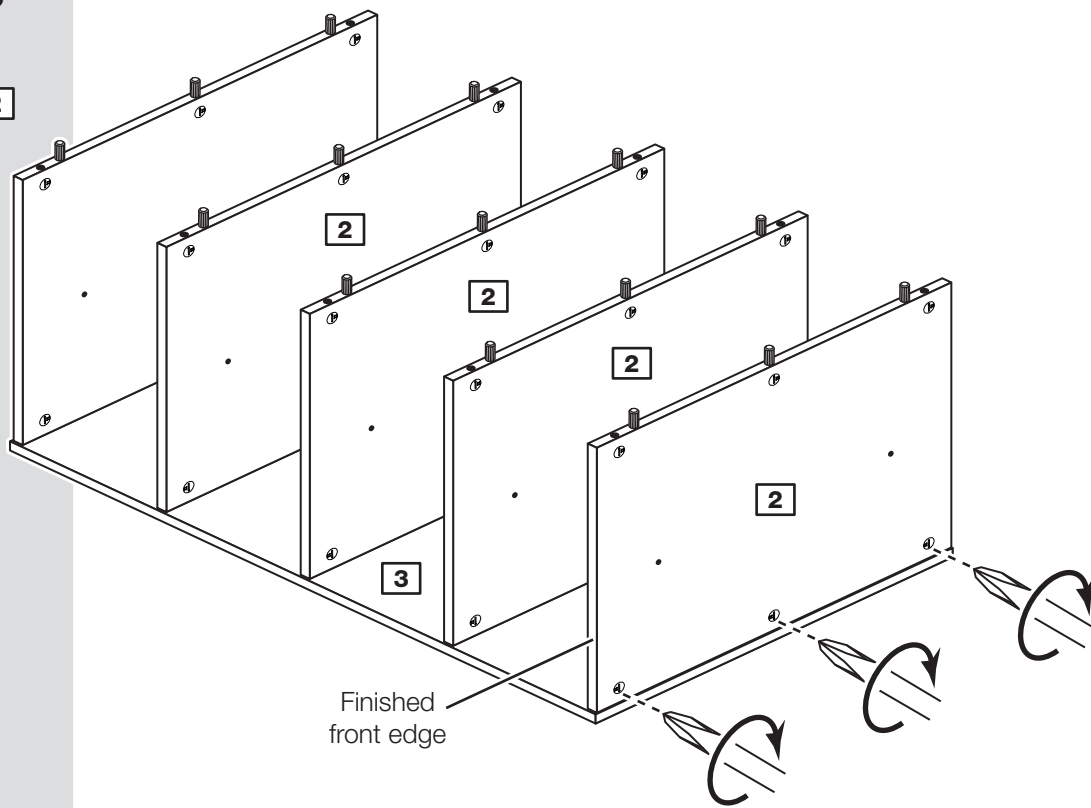

Step 5

Fit the top

Push the top **3** down onto the assembly.

Use a screwdriver to tighten the 3 large locking nuts **B** fitted to the side **1** and each of the 4 dividers **2**.

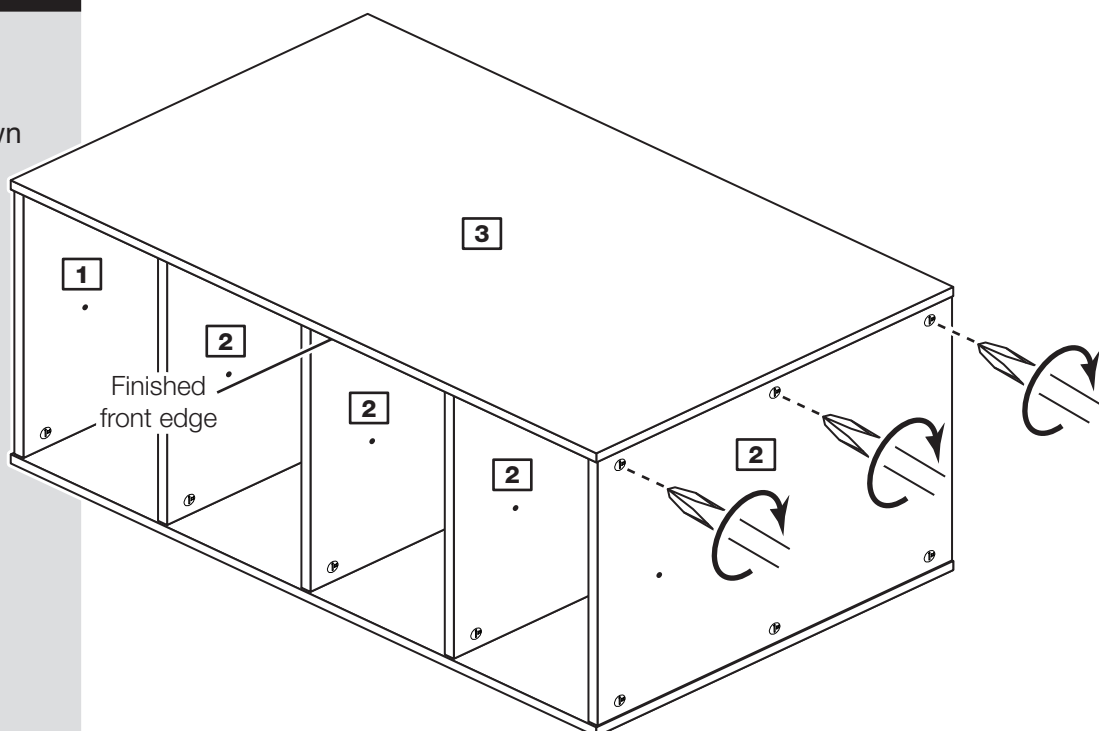

Assembly Instructions

Step 6

Fit the shelf studs

Push 4 shelf studs **D** for each shelf **4** into the side **1** and dividers **2**, as shown.

Note: The screws in the shelf studs must be pointing upwards.

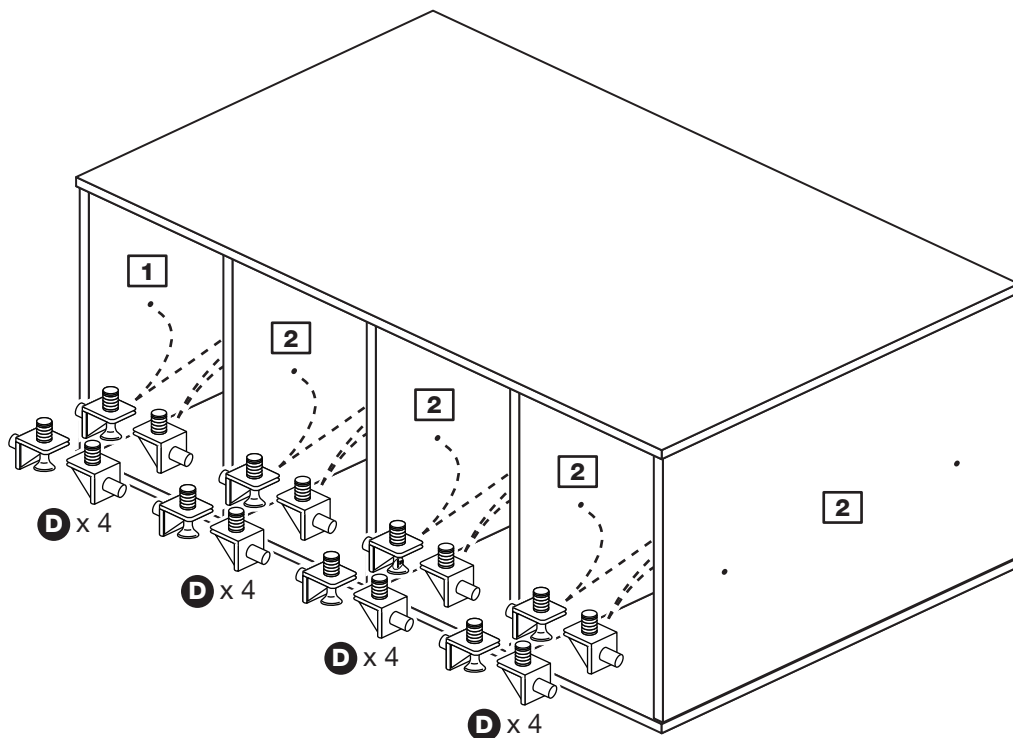

Step 7

Fit the 4 shelves

Lower the shelves **4** down onto the shelf studs **D** and tighten their screws.

Assembly is complete

The unit can now be placed inside your wardrobe.

If you are standing the unit up, the side panel must be at the top so there are no holes showing.

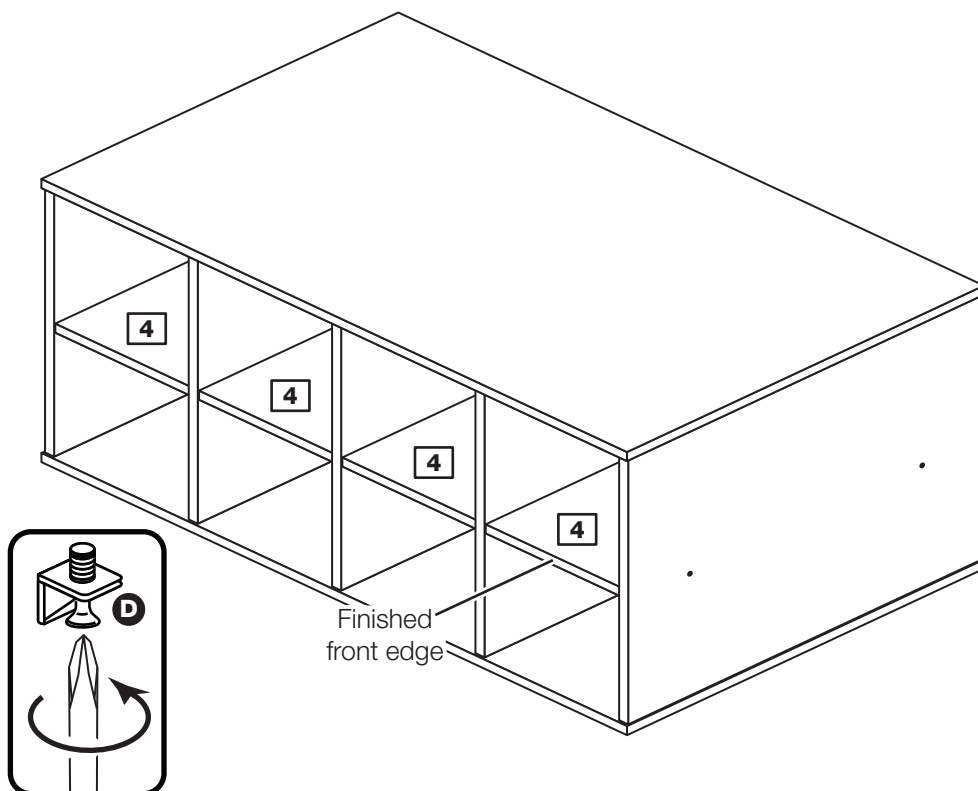

If you need help or have damaged or missing parts, call the Customer Helpline: 08456 400800 and quote the reference numbers on the component pages.

Argos Ltd, 489-499 Avebury Boulevard, Central Milton Keynes, MK9 2NW