

Futon Bunk Bed

Assembly Instructions - Please keep for future reference

758/4512

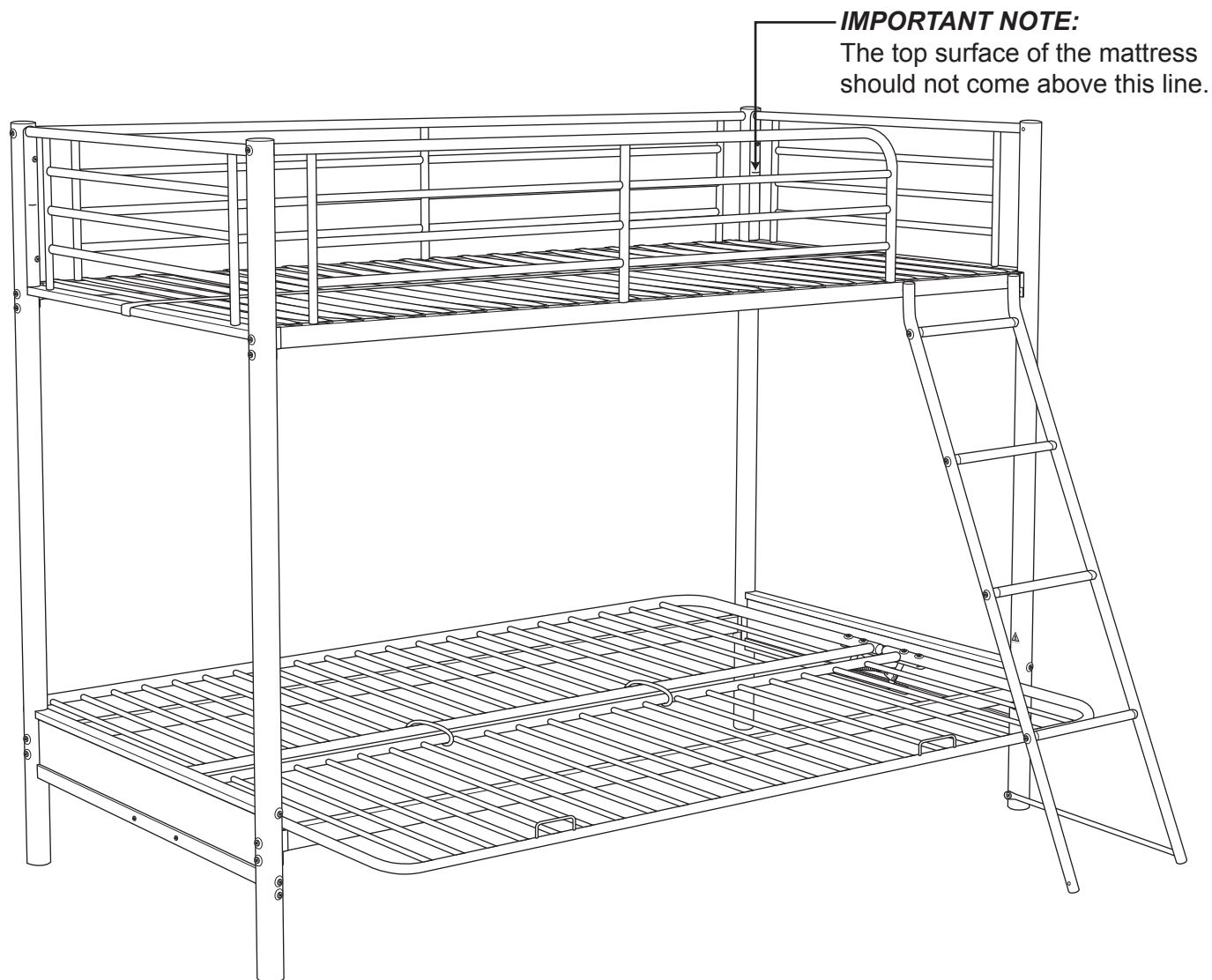

Dimensions

Width - 200cm

Depth - 99/174cm

Height - 165cm

Important - Please read these instructions fully before starting assembly

If you need help or have damaged or missing parts, call the **Customer Helpline: 08456 400800**



Safety and Care Advice

Important - Please read these instructions fully before starting assembly

- Because of the size of this unit, it is recommended to assemble it in the room intended for use.
- Do not discard any of the packaging until you have checked that you have all the parts and the pack of fittings.
- Discard all extra fittings and keep fittings out of reach of children.

- Assemble this product on a flat surface.
- Assemble all parts loosely before tightening any bolts.
- At least 2 people are required to assemble this product.
- Unit weight: 54kgs.
- Retain Assembly Instructions for future reference.



- We do not recommend the use of power drill/drivers **for inserting screws**, as this could damage the unit. Only use hand screwdrivers.
- Dispose of all packaging carefully and responsibly.

Warnings

• READ CAREFULLY - RETAIN FOR FUTURE REFERENCE

- Regularly check and ensure that all bolts and fittings are tightened properly.
- Always use the ladder for entering and leaving the upper bunk.
- The recommended mattress size is L1900 x W910 mm.
- Ensure thickness of mattress does not exceed 220 mm.
- Refrain from using the bunk bed if any structural part is broken or missing.

- Please advise your children to only enter and leave the upper bunk by using the ladder.
- Please prohibit more than one person on the upper bunk.
- Please prohibit children from jumping on the upper and lower beds.
- **WARNING:** Do not allow children under 6 years of age to use the upper bunk due to risk of injury and falls.
- **STRANGULATION HAZARD** - Never attach or hang items such as ropes, strings, cords,

harnesses and belts to any part of the bunk bed.

- **WARNING:** Children can become trapped between the bed and the wall. To avoid risk of serious injury the distance between the top safety barrier and the wall shall not exceed 75 mm or shall be more than 230 mm.
- Folding and unfolding the futon should only be carried out under adult supervision.
- **THIS BED COMPLIES WITH EN747-1:2012 / EN747-2:2012**

Care and maintenance

- Please clean the unit surface using either damp (not wet) cloth and a mild domestic soap solution or by using an appropriate polish.

- Do not use any abrasive materials when cleaning.

- From time to time check that there are no loose bolts on this unit.

Note: if required the next page can be cut out and used as reference throughout the assembly. Keep this page with these instructions for future reference.

Components - Parts

Please check you have all the parts listed below

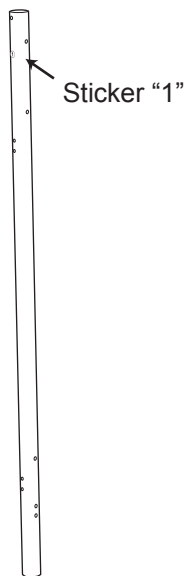

1 Back end post x 2
(Ø5 x 165cm)

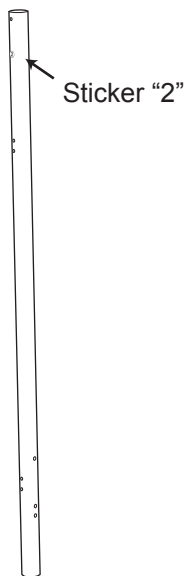

2 Front left-hand end post
(Ø5 x 165cm)

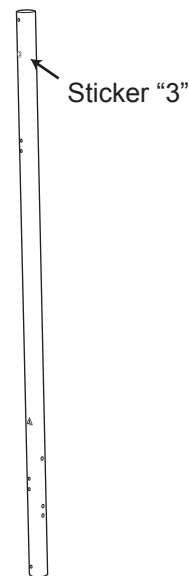

3 Front right-hand end post
(Ø5 x 165cm)

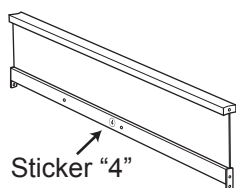

4 Lower left side rail
(89.5 x 24 x 2.5cm)

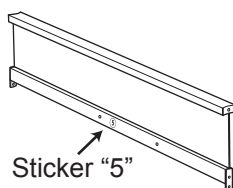

5 Lower right side rail
(89.5 x 24 x 2.5cm)

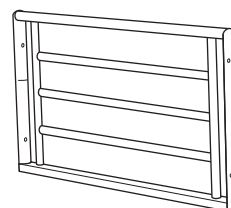

6 Upper side safety rail x 2
(91 x 36 x 4cm)

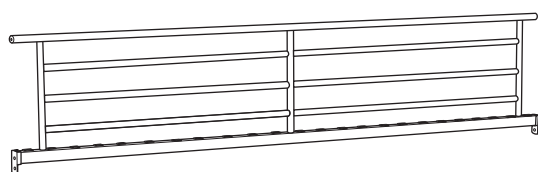

7 Upper back safety rail
(190.5 x 41.5 x 2.5cm)

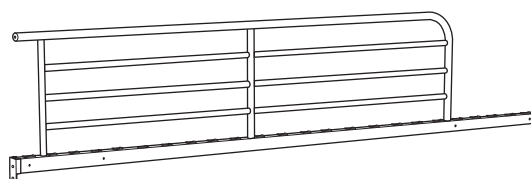

8 Upper front safety rail
(190.5 x 41.5 x 2.5cm)

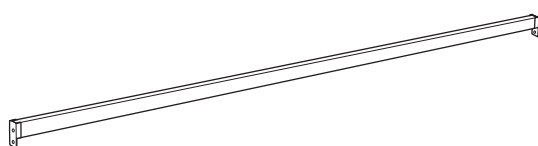

9 Lower rail x 2
(190.5 x 6.5 x 2.5cm)

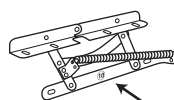

10 Left futon mechanism
(43 x 17.5 x 5.5cm)

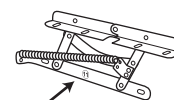

11 Right futon mechanism
(43 x 17.5 x 5.5cm)

Components - Parts (cont.)

Please check you have all the parts listed below

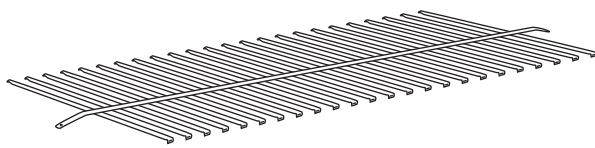

12 Slats (with webbing attached) x 24
(94 x 1.6 x 2.5cm)

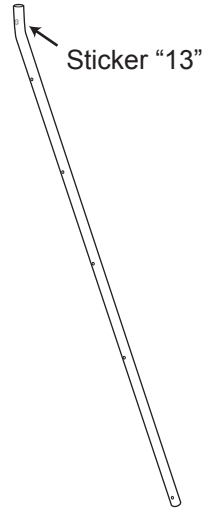

13 Left ladder side rail
(150 x Ø2.5cm)

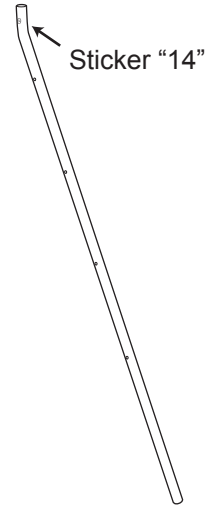

14 Right ladder side rail
(150 x Ø2.5cm)



15 Ladder step x 4
(Ø2.5 x 29 cm)



16 Ladder brace
(76.5 x 1.5 x Ø1cm)



17 Futon clamp x 2
(13 x 4 x Ø0.5cm)

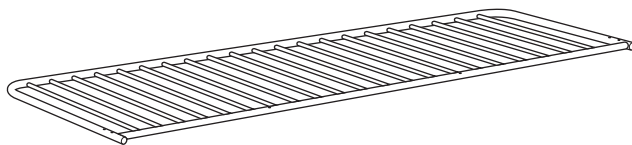

18 Back futon frame
(188 x 69.5 x 2.5cm)

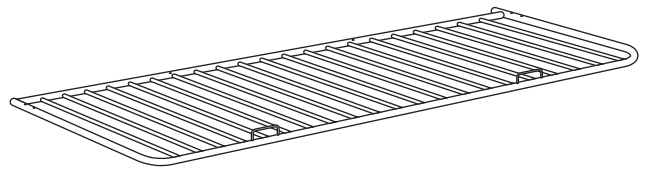







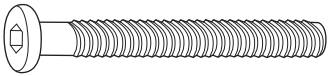
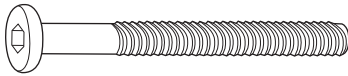
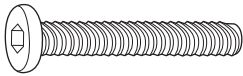
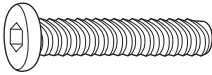
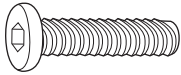
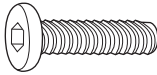
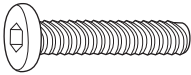
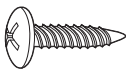

19 Front futon frame
(188 x 69.5 x 6cm)

Components - Fittings

If you have damaged or missing components, call the **Customer Helpline: 08456 400800**

Please check you have all the fittings listed below

Note: The quantities below are the correct amount to complete the assembly. In some cases more fittings may be supplied than are required.

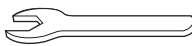
A  M8 x 60mm Bolt x 24	B  M6 x 80mm Bolt x 7	C  M6 x 50mm Bolt x 8
D  M8 x 40mm Bolt x 8	E  M8 x 30 mm Bolt x 4	F  M6 x 20 mm Bolt x 10
G  M6 x 35mm Bolt x 2	H  Screw x 2	I  M8 Lock nut x 24
J  M8 Curved washer x 32	K  M6 Curved washer x 15	L  Plastic washer x 8
M  Adhesive pad x 4	N  Wall strap x 1	O  Spring washer x 8
P  Allen key x 1	Q  Spanner x 1	

Tools required

 Crosshead screwdriver

Ruler - Use this ruler to help correctly identify the screws

0 5 10 15 20 25 30 35 40 45 50 55 60 65 70 75 80 85 90 95 100 105 110 115 120 125 130 135 140 145 150 155 160 165 170

Assembly Instructions

Step 1

Assembling end panels

Lay all parts flat on a soft surface on the floor to avoid damaging any of the parts.



Note: Identify and correctly position the end posts **1**, **2** & **3** by looking for the sticker labels pasted on the post.

a: Attach the lower right side rail **5** to back end post **1** and front right-hand end post **3** & secure using washers **J** & **K**, bolts **A** & **B** and nuts **I** as shown.



Note: Do not fully tighten bolts at this stage.

b: Attach the upper side safety rail **6** into position & secure using bolts **F**.



Note: Fully tighten bolts all bolts using allen key **P**.

Repeat above steps to assemble the left-hand end panel using end posts **1** and **2**, upper side safety rail **6**, lower left side rail **4** as shown in the diagram.

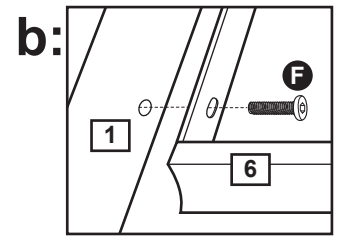
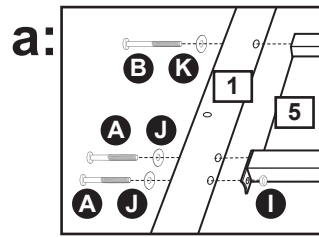

RIGHT-HAND END PANEL

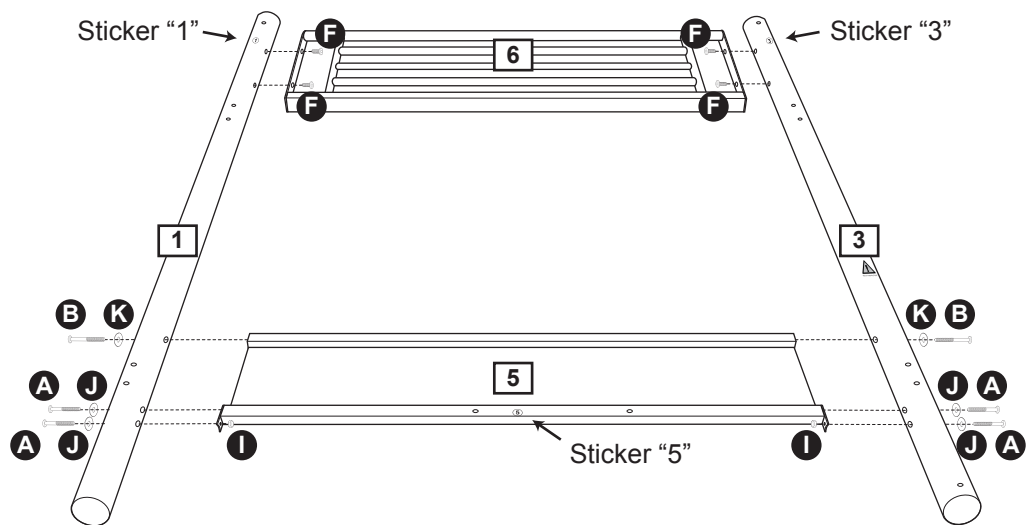

LEFT-HAND END PANEL

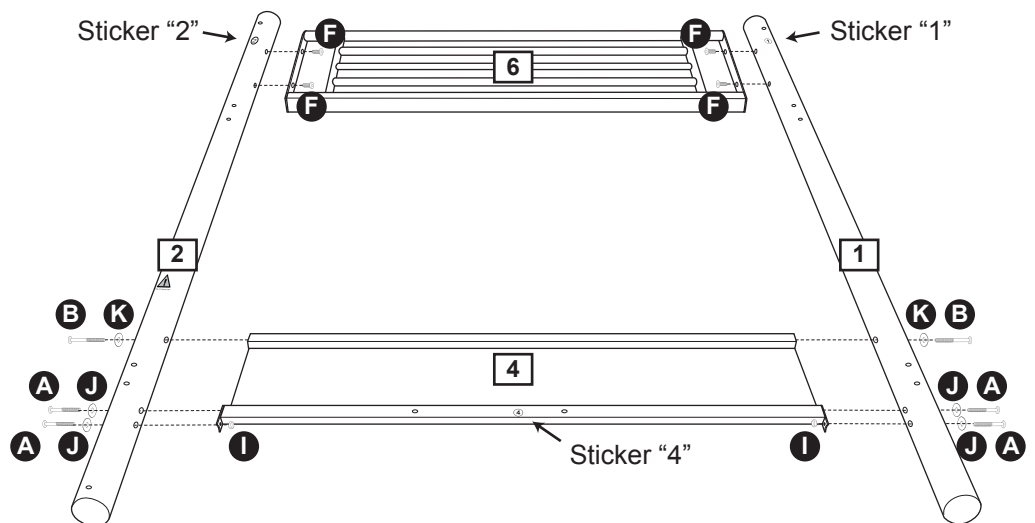

Assembly Instructions

Step 2

Attaching rails



Note: Determine your preferred bunk bed entry position. Then attach the front safety rail **8** with the entry space positioned on the left or right.

a: Identify the correct rails for assembly and with the help of an assistant attach the lower tubes of upper back safety rail **7**, upper front safety rail **8** and lower rails **9** to end posts using bolts **A**, washers **J** and nuts **I**.



Note: Do not fully tighten bolts at this stage.

b: Attach the top tubes of upper back safety rail **7** and upper front safety rail **8** to end posts using bolts **B** and washers **K**.



Note: After all bolts are positioned, fully tighten all bolts & nuts using allen key **P** and spanner **Q**.

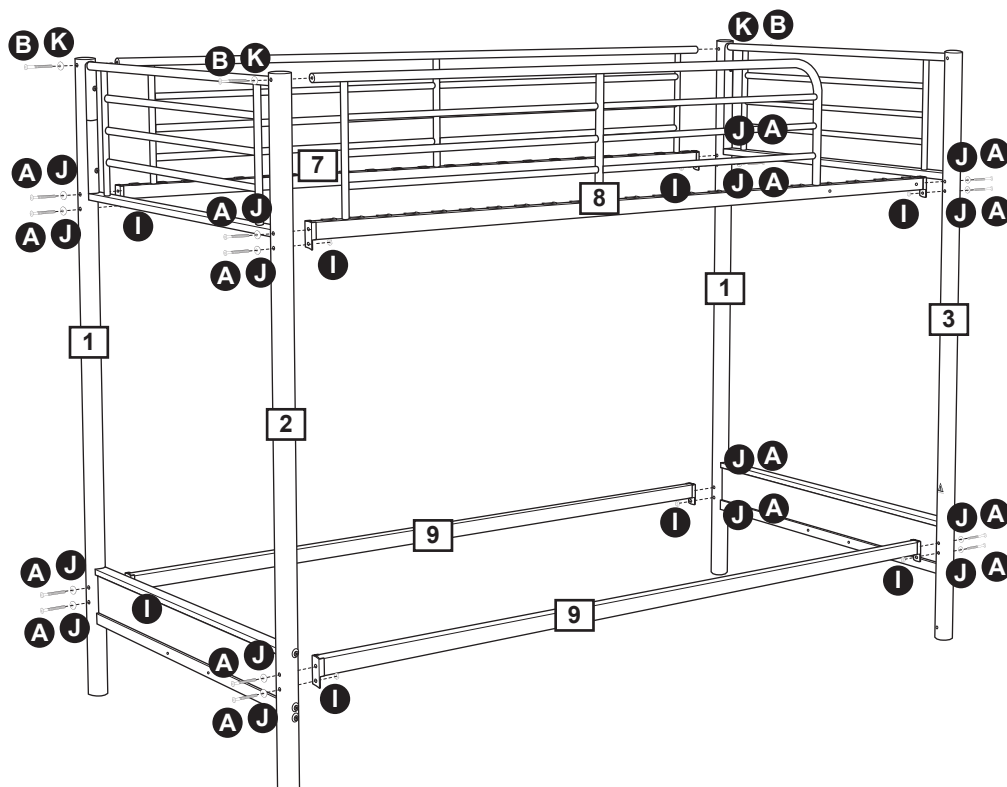
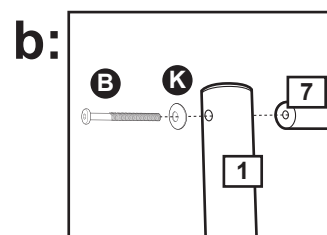
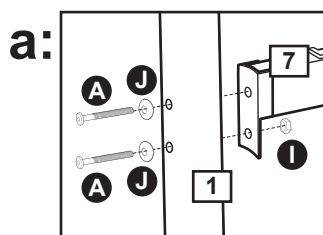

Option for right upper bunk entry

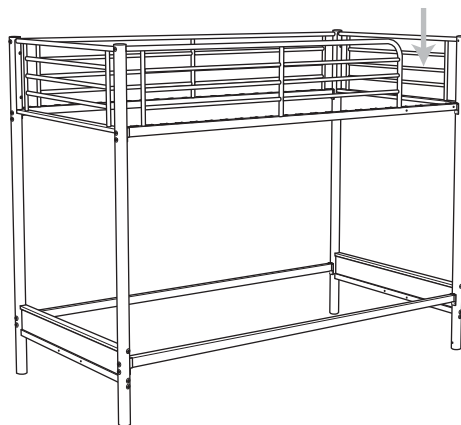

Option for left upper bunk entry

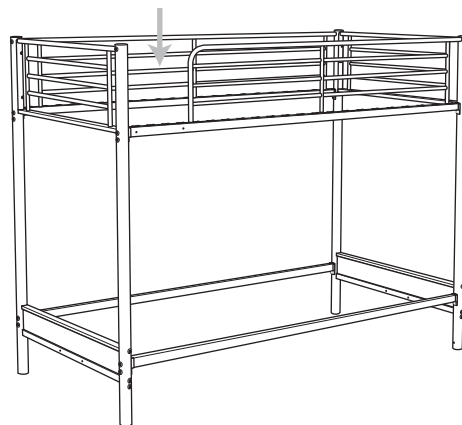

Assembly Instructions

Step 3

Attaching slats

a: With the help of an assistant, line up the slats **12** onto upper rails **7** & **8**. Push firmly down to lock it into position. Check that they cannot be removed by slightly pulling upwards.

b: Extend the end of the webbing on the slats **12** and secure to bottom edge of side safety rails **6** using screws **H**. Tighten screws using a crosshead screwdriver.

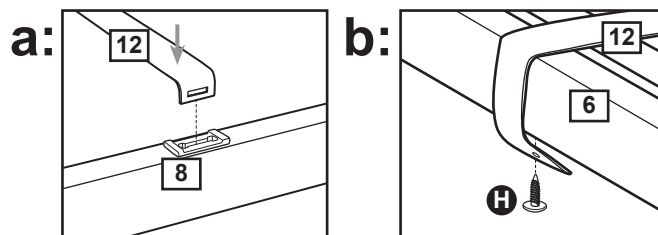
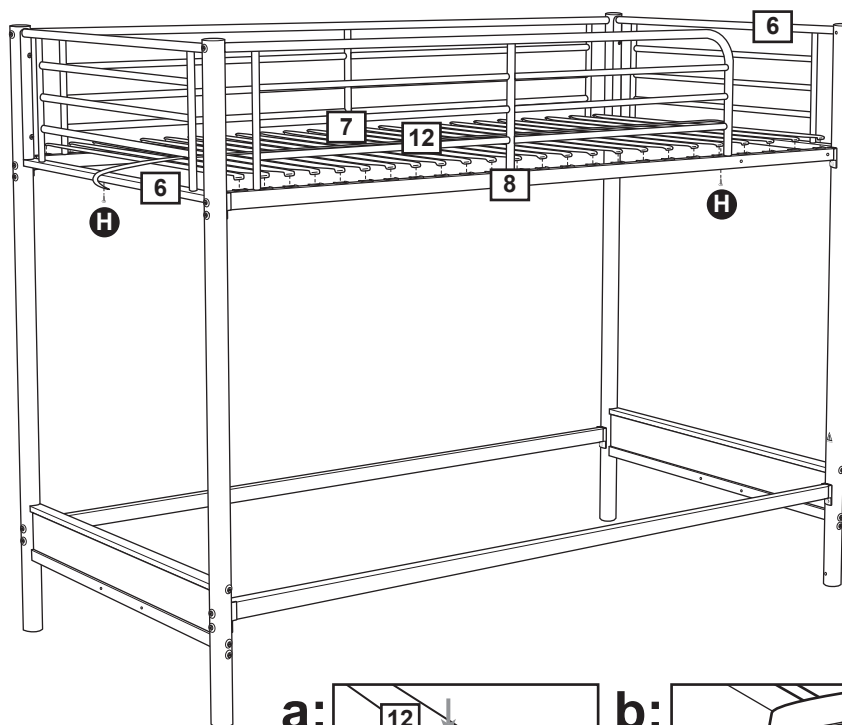

Step 4

Assembling futon mechanisms

Correctly position the left **10** & right **11** futon mechanisms and attach to lower side rails **4** & **5** using bolts **E** and nuts **I**. Tighten bolts & nuts using allen key **P** and spanner **Q**.

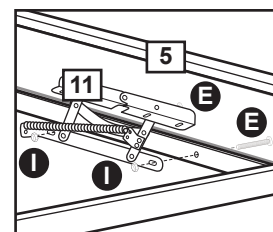
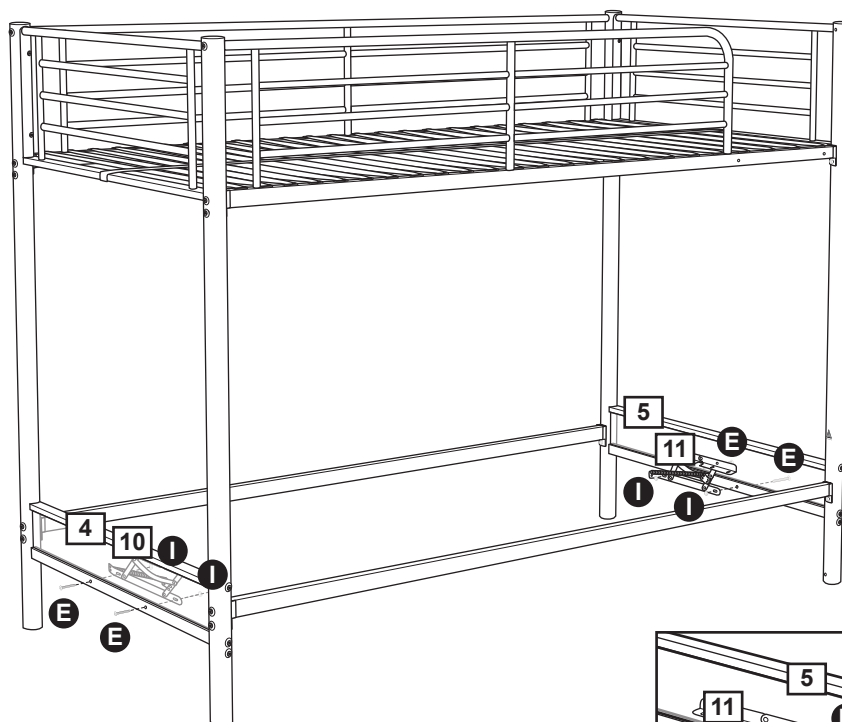

Assembly Instructions

Step 5

Assembling front futon frame

a: Position the front futon frame **19** as shown and secure it to futon mechanisms **10** & **11** with bolts **D**, washers **J** and nuts **I**. Tighten bolts and nuts using allen key **P** and spanner **Q**.

b: Position the futon clamps **17** as shown and carefully hook one end on front futon frame **19**.

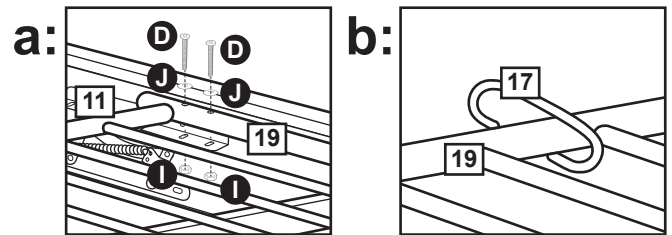
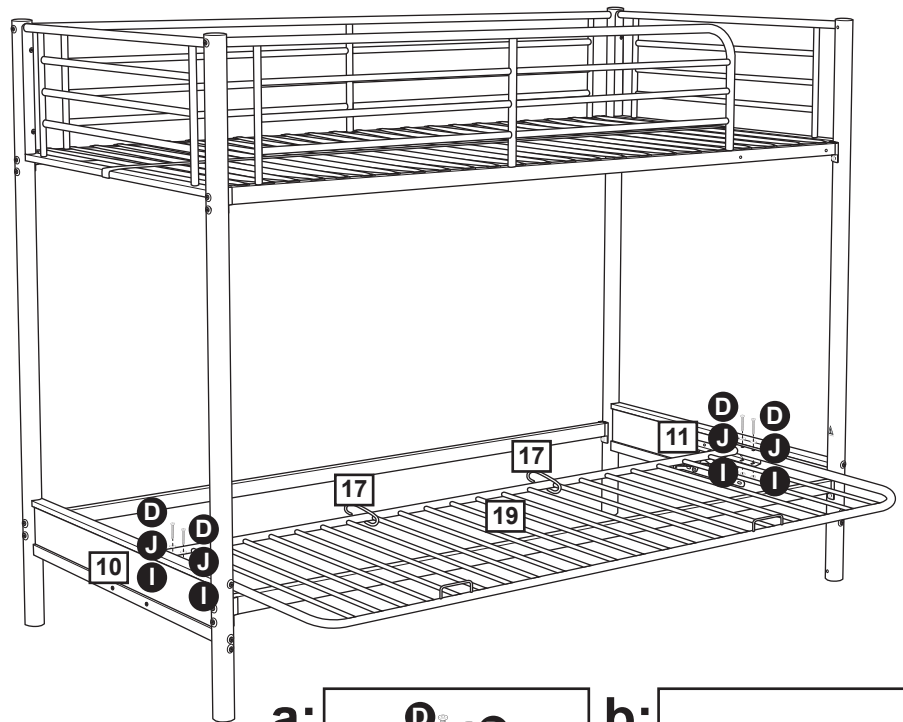

Step 6

Assembling back futon frame

a: Position the back futon frame **18** and carefully hook the other end of futon clamps **17** as shown.

b: Fix the back futon frame **18** to futon mechanisms **10** & **11** with bolts **D**, washers **J** and nuts **I**. Tighten bolts and nuts using allen key **P** and spanner **Q**.

c: Remove backing from adhesive pads **M** and carefully position at the four corners between the lower rails **9** and futon frames **18** & **19**.

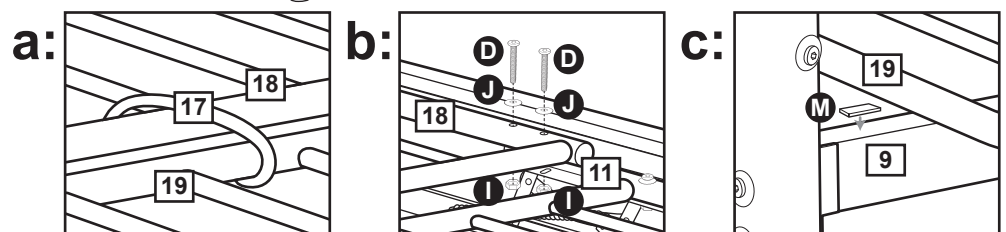
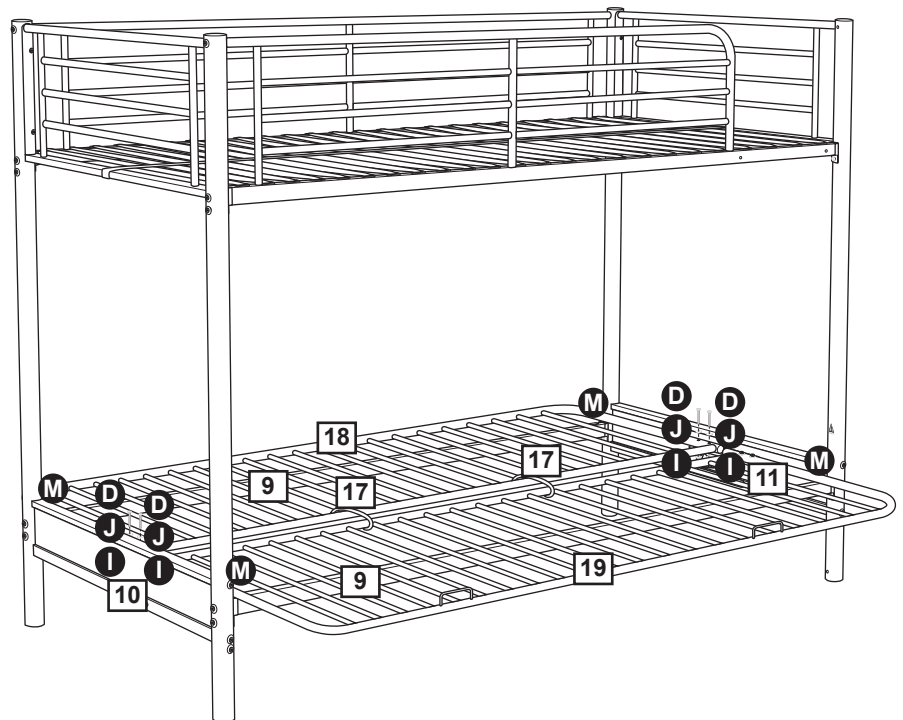

Assembly Instructions

Step 7

Assembling ladder

Referring to diagram, attach the ladder steps **15** to ladder side rails **13** & **14** using bolts **C**, spring washers **O**, curved washers **K** and plastic washers **L**. Tighten all bolts using allen key **P**.



Note: Identify and correctly position the ladder side rails **13** & **14** by looking for the sticker labels pasted on the parts.

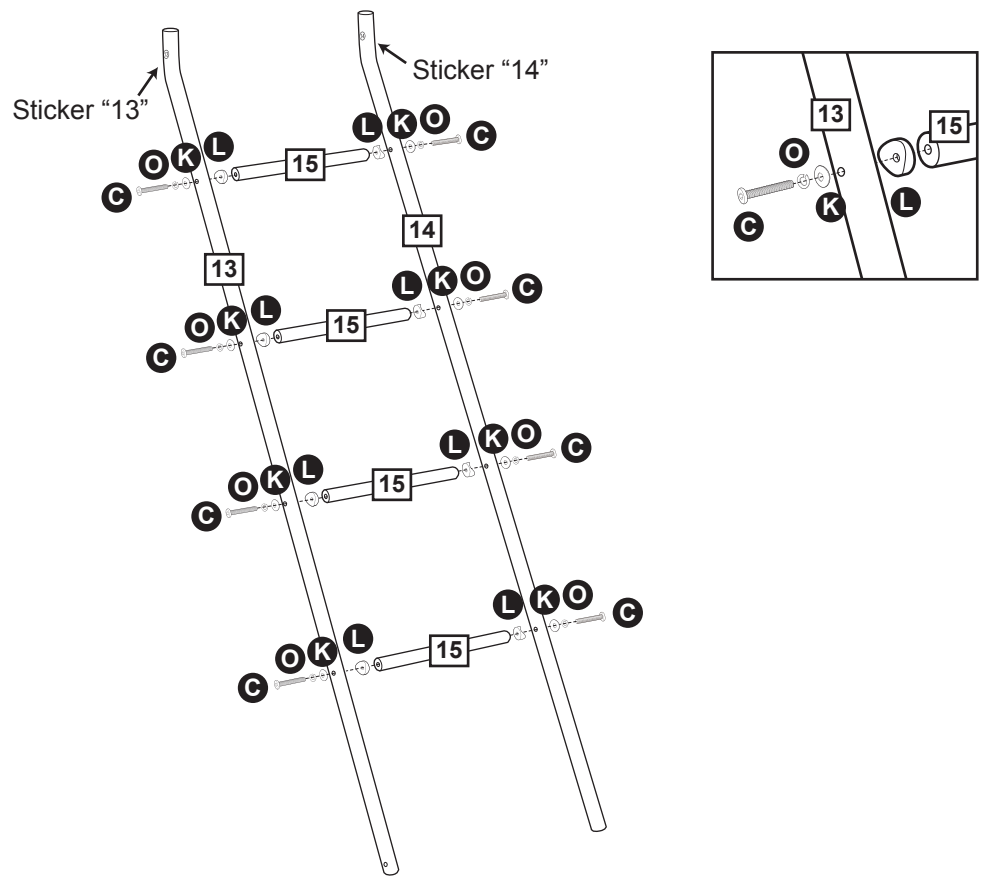

Step 8

Attaching ladder

Attach the ladder to the upper front safety rail **8** using bolts **G** as shown. Tighten bolts using allen key **P**.

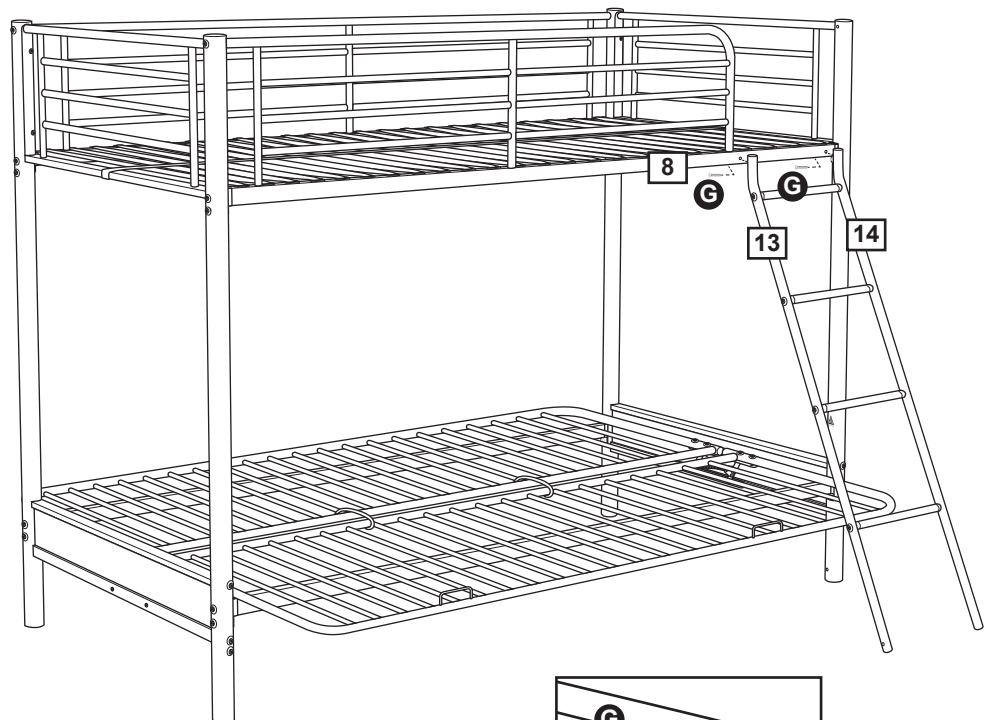

Assembly Instructions

Step 9

Securing the ladder

Attach the ladder brace **16** to ladder side rail **14** & front right-hand post **3** using bolts **F**. Tighten bolts using allen key **P**.

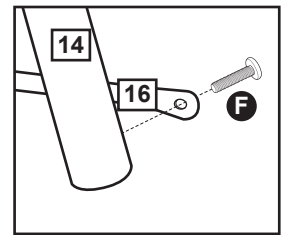
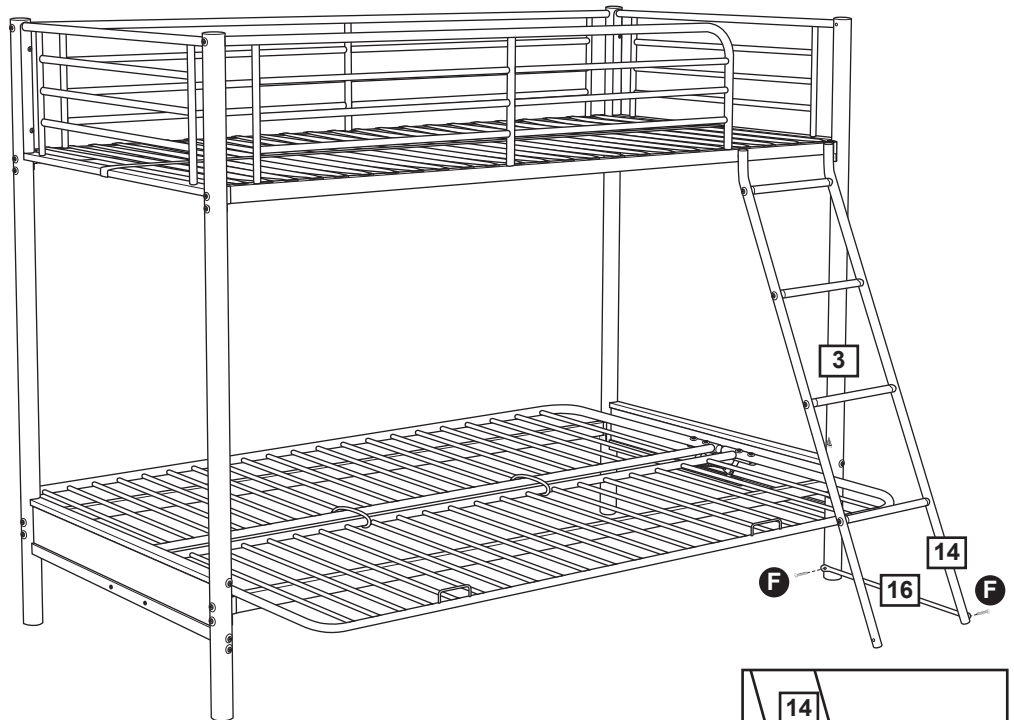

Step 10

Fixing to wall

This unit must be fixed to a wall.

Move the bunk bed into position on the wall. Position the wall strap **N** to the top post of upper back safety rail **7** to mark fixing holes on the wall. Remove the wall strap then drill holes and insert appropriate wall plugs. Reposition wall strap **N** & fix using appropriate screws.



Warning: Before drilling, check wall for hidden pipes and cables. Consult a qualified specialist if unsure.

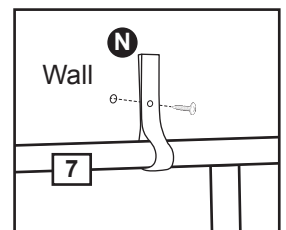
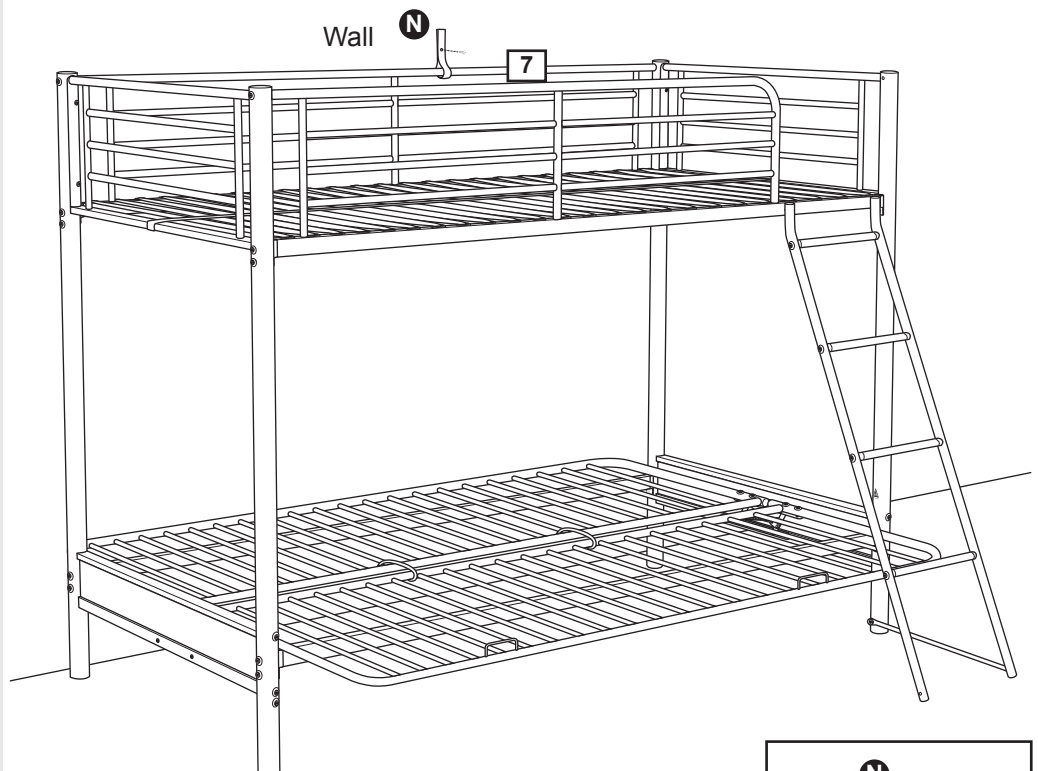

Assembly is complete.

Operation Instructions

Step 1

Folding the futon

a: Slightly pull up the futon from the front edge.

b: Push it in to fold the futon frame.

c: Then carefully put down the futon as shown.

a:

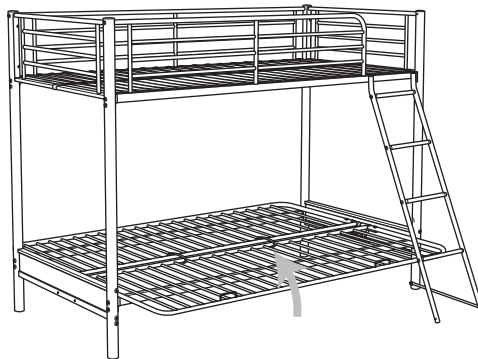

b:



c:

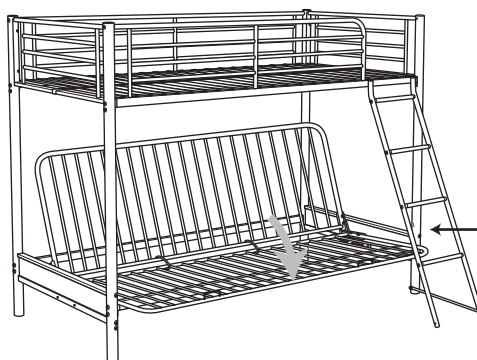

Risk of trapping finger.



Warning: Keep hands away from hinges, folding mechanisms & edges to prevent possible entrapment or injury.

Step 2

Opening the futon

a: Slightly pull up the futon from the front edge.

b: Pull it out to unfold the futon frame.

c: Then carefully put down the futon as shown.

a:

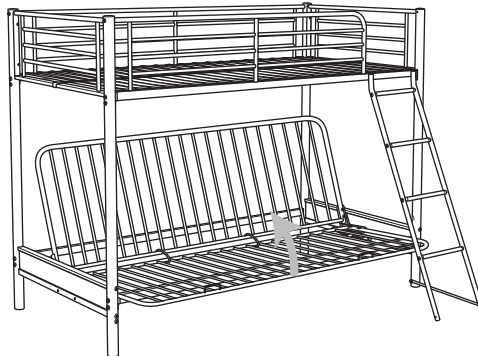

b:

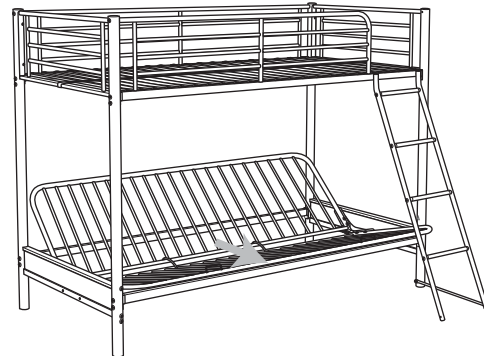

c:

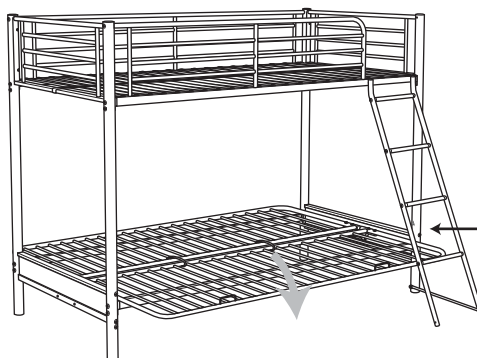

Risk of trapping finger.



Warning: Keep hands away from hinges, folding mechanisms & edges to prevent possible entrapment or injury.

If you need help or have damaged or missing parts, call the **Customer Helpline: 08456 400800**