

BUSH Fridge Freezer

Installation & User Instructions – Please keep for future reference

162/4241

158/4044

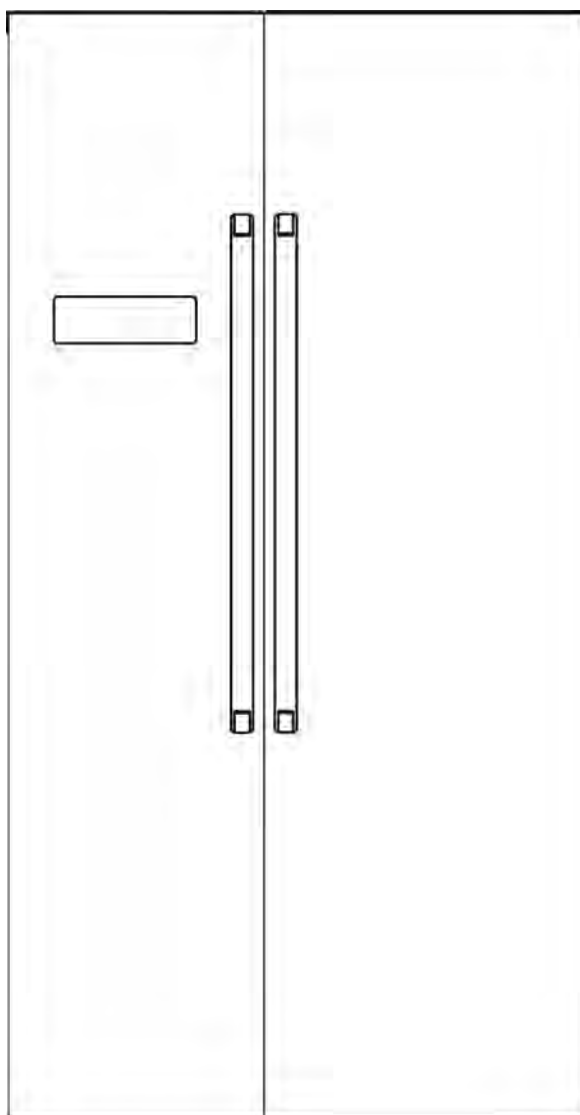

Important – Please read these instructions fully before installing or using

These instructions contain important information which will help you get the best from your appliance and ensure safe and correct installation, use and maintenance. Please keep this manual for further references

If you need help or have damaged or missing parts, call the Customer Helpline: 0345 600 4632

Contents

Safety Information	2
Parts	3
Installation	4-5
Transportation	4
Installation	4-5
Electrical connection	6
User Instructions	7-10
Before first use	7
Using your appliance	7
Useful information	8
Defrosting	8-10
Care and Maintenance	11-12
General	11
Light bulb replacement	11
Power failure	11
Moving your appliance	12
Disassembly/assembly of the door	12
Trouble Shooting	13
Technical Specifications	14
Disposal information	14
Guarantee	15

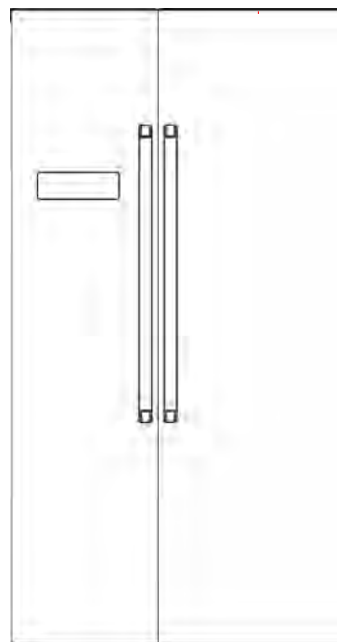

Product codes

BSBSFFSS-Silver
BSBSFFB-Black



Safety Information

Important – Please read these instructions fully before installation

Before use

The installation of this appliance is best carried out by 2 people.

- Dispose of all packaging carefully and responsibly.
- The appliance is designed for **indoor use only** and must be protected from rain, moisture and extreme temperature variations.
- This appliance is designed for household use. **Do not** use the appliance for industrial and commercial use, or any other purpose.
- The appliance **MUST** be positioned on a firm level base.
- **Do not** splash water on the appliance. It may cause electrical parts to fail and result in an electric shock.
- Leave the appliance in its intended place of installation and in its correct orientation for at least 4 hours before switching on to allow the cooling system to settle before first use or after any transportation.
- *Your appliance is an environmental friendly product and it contains non CFC / HFC gas substances in the cooling system (Called R600a) and in the insulation (Called cyclopentane) which are potentially flammable if exposed to fire. Therefore, take care not to damage, the cooling circuit / pipes of the appliance in transportation and in use. In case of damage do not expose the appliance to fire, potential ignition source and immediately ventilate the room where the appliance is situated.*
- **Do not** sit, stand or place any other heavy objects on top of the appliance. This could result in personal injury or damage to the appliance.
- **Do not** allow children to play with the appliance to avoid the risk of entrapment and suffocation.
- Keep ventilation opening, in the appliance enclosure or in the built-in structure, clear of obstruction.

During use

- This appliance is not intended for use by persons (including children) with reduced physical, sensory or mental capabilities, or lack of experience and knowledge, unless they have been given supervision or instruction concerning use of the appliance by a person responsible for their safety. Children should be supervised to ensure that they do not play with the appliance.
- This appliance is not intended for use by young children or infirm persons unless they have been adequately supervised by a responsible person to ensure that they can use the appliance safely. Young children should be supervised to ensure that they do not play with the appliance.
- **Do not** use mechanical, electrical or chemical ways to speed up the defrost process not recommended by the manufacturer.
- **Do not** use or place other electrical products inside the appliance not recommended by the manufacturer.
- **Do not** store liquids in glass containers in the freezer compartment as these may shatter.
- **Do not** store flammable materials such as non-consumable alcohol, gasoline, LP gas or glue etc in the appliance.
- In case there is an inflammable gas leak, open the window for air circulation and do not pull out the mains plug or adjust the temperature knob.
Do not touch the appliance until the valve of gas is turned off. Otherwise, sparks may occur.
- **Do not** attempt to repair the appliance yourself. Contact the Customer Helpline: 0345 600 4632.

Parts

If you have damaged or missing parts,
call the **Customer Helpline: 0345 600 4632**

Please familiarize yourself with the parts and accessories listed below

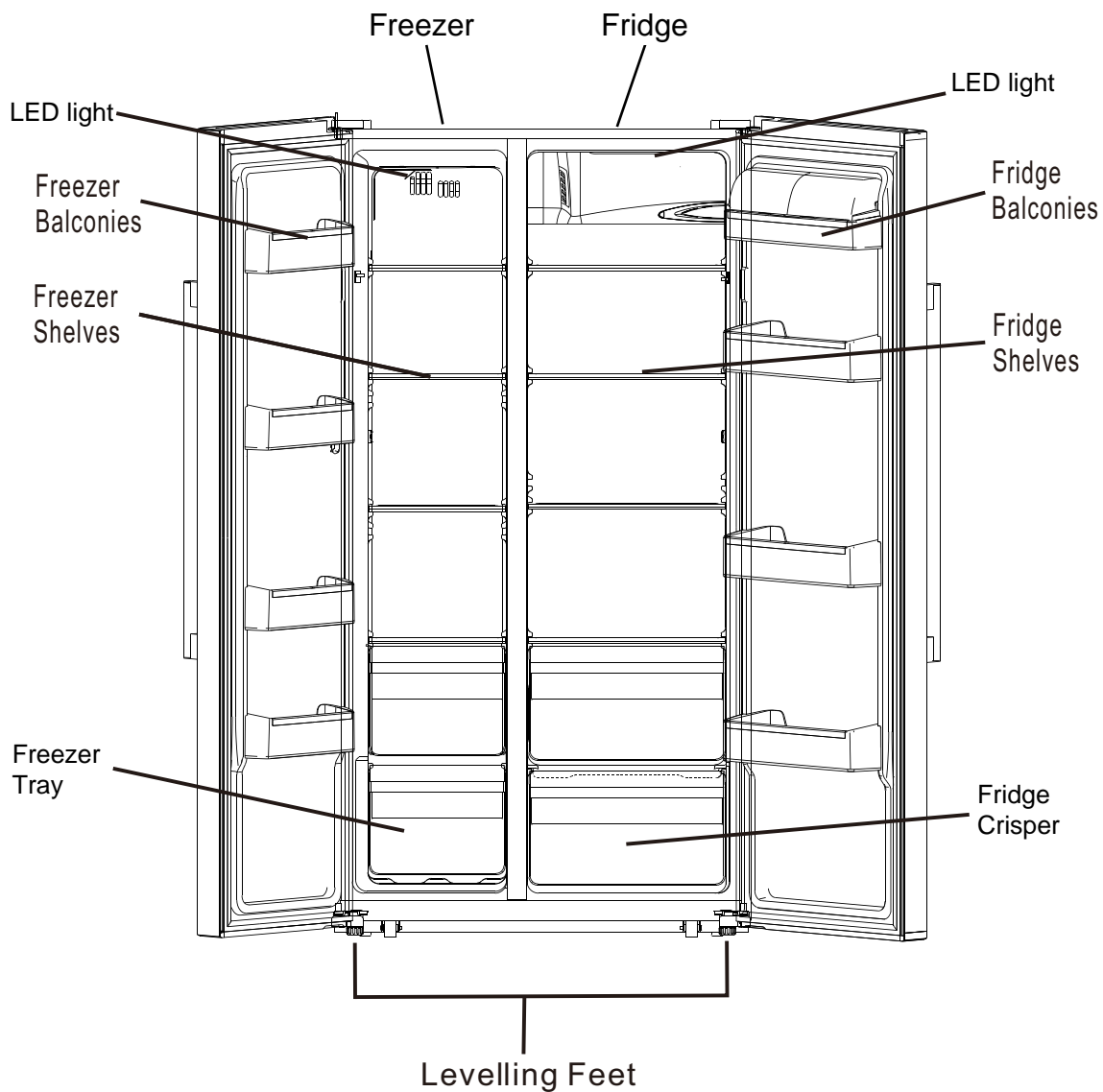

Note: Above picture is for reference only. Real appliance may be different.

Accessories included



Instruction x 1

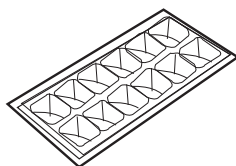

Ice-cube tray x 2



Spacers x 2

Installation

Transportation

⚠ Caution: 2 people are required to unpack and handle the appliance, it is recommended that gloves are worn.

- The appliance should be transported only in an upright position. Do not tilt the appliance greater than 45°. The packaging as supplied must be intact during transportation.
- After transporting the appliance, leave it for at least 4 hours before switching on to allow the cooling system to settle. Failure to comply could result in damage to the appliance.
- Do not move the appliance by pulling the door or handle as it may damage your flooring and wall coverings etc.
- Empty any water in the drain tray before moving.
- Make sure that the defrost water pipe at the back of the product is fixed to the plastic evaporating pan on the top of the compressor, to avoid defrost water spillage on the floor.
- Ensure the electrical cable is not caught under the appliance during and after moving.
- Carefully remove all packaging materials including the foam base, dispose of correctly.

Installation

- Ensure sufficient spacing is provided for the appliance to be installed. Leave space on both sides (50mm), back (100mm) and above the appliance (50mm) to ensure proper ventilation and door opening. See fig. 1 & 2
- Do not place the appliance near a heat source or in direct sunlight.
- Do not put any heavy objects on top of the appliance. It will damage the appliance.
- Do not install the appliance in a moist or wet place. It should be installed on a smooth surface to avoid excessive vibration and noise.
- The appliance is equipped with four castors on the bottom side for easy movement. Ensure the two leveling feet on the front side have been screwed upwards. Then move the appliance to right location.
- Screw the leveling feet downwards to fix the appliance in place.
- Try some operations, i.e. Open/close door to confirm the appliance will not move under normal usage/operation. If the appliance moves, adjust the leveling feet again until it is fixed and do not move (See fig.3).
- If you need to relocate the appliance, please ensure the leveling feet on the front side have been screwed upwards before you move the appliance.

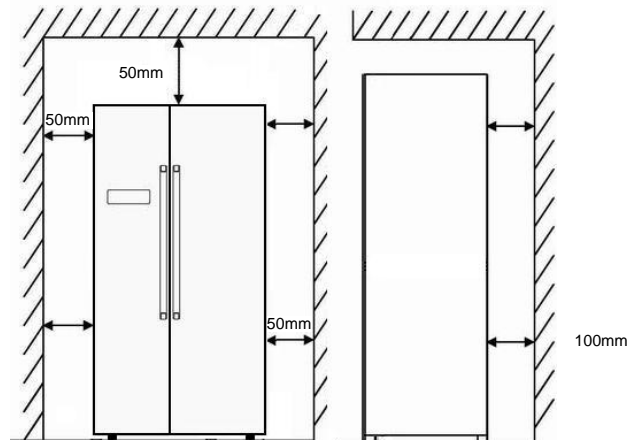

Fig. 1

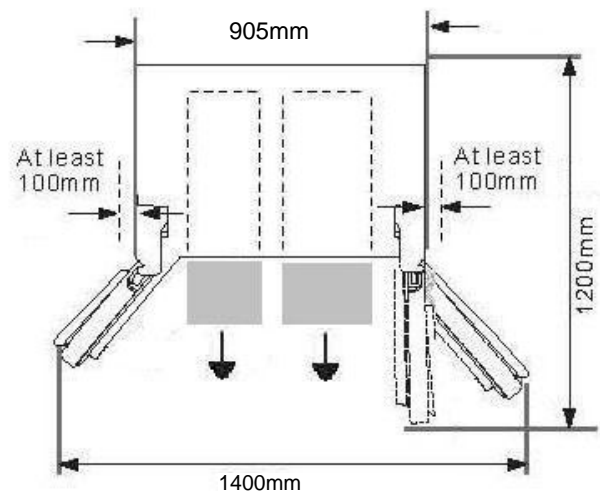

Fig. 2

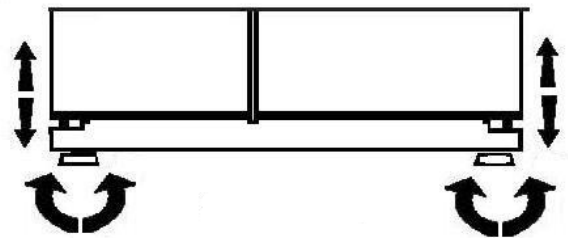
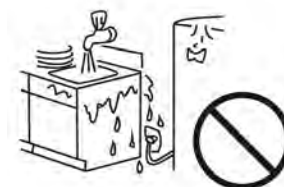

Fig. 3



Installation

Installation

- Screw in the two spacers (provided) at the back of the appliance before operation. See fig. 4
- Each appliance has a climate class (shown on the rating plate) that indicates the operating temperature range of the appliance. The appliance may not work properly if it is left for a long period at a temperature outside the specified range.
- Refer to section “Care and Maintenance” to prepare your appliance for use.

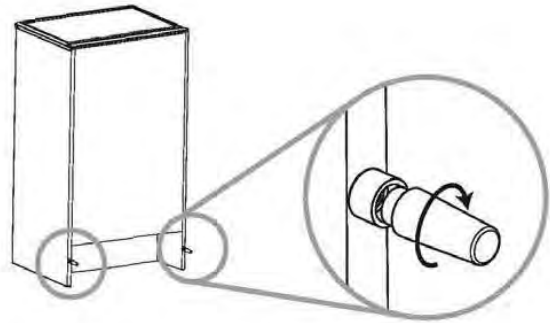

Fig. 4

Climate Class	Amb. T. (°C)	Amb. T. (°F)
SN	10 ~ 32°C	50 ~ 90°F
N	16 ~ 32°C	61 ~ 90°F
ST	18 ~ 38°C	64 ~ 100°F
T	18 ~ 43°C	64 ~ 110°F

Installation

Electrical connection



Any electrical work that is required to install this appliance **MUST** be carried out by a qualified electrician.



Warning: THIS APPLIANCE MUST BE EARTHED

Before making any electrical connections, ensure that:

- Electrical safety is only guaranteed when the earth system of your house is in accordance with the related local regulations.
- Do not damage the refrigerant circuit.
- Do not bend, stretch or pull the supply cable to avoid electric shock.
- Do not use electrical appliances inside the food storage compartments of the appliance, unless they are of the type recommended by the manufacturer.
- Ensure the power socket is suitable for the maximum power of the machine (fuses in the power circuit must be 13 amp).
- The supply voltage should be the same as that indicated in the technical specifications and the appliance rating plate.
- The appliance should be earthed and in compliance with the applicable law.
- When installed, the power socket must be within easy reach.
- If the socket outlets in your home are not suitable for the plug supplied with this unit check with a qualified electrician for replacement.
- The use of adapters, multiple connectors or extension cables are not recommended.
- The appliance must be connected to a 220-240 volt 50Hz AC supply by means of a three pin socket, suitably earthed and protected by a 13 amp fuse.
- Should the fuse need to be replaced, a 13 amp fuse approved to BS1362 must be used.
- The plug contains a removable fuse cover that must be refitted when the fuse is replaced. If the fuse cover is lost or damaged, the plug must not be used until a replacement cover has been fitted or the plug is replaced.
- A damaged plug should be cut off as close to the plug body as possible, the fuse should be removed and the plug disposed of safely.

Plug replacement (UK & Ireland only)

Should you need to replace the plug; the wires in the power cable are coloured in the following way:

Blue – Neutral 'N'

Brown – Live 'L'

Green & Yellow – Earth 'E'

As the colours of the wires in the power cable may not correspond with the coloured markings identifying the terminals in your plug, and proceed as follows:

The green & yellow wire must be connected to the terminal in the plug that is marked with the letter E or by the earth symbol.

The blue wire must be connected to the terminal that is marked with the letter N.

The brown wire must be connected to the terminal that is marked with the letter L.

If power supply cord is damaged, it must be replaced by the manufacturer or its service agent or a similar qualified person in order to avoid a hazard.

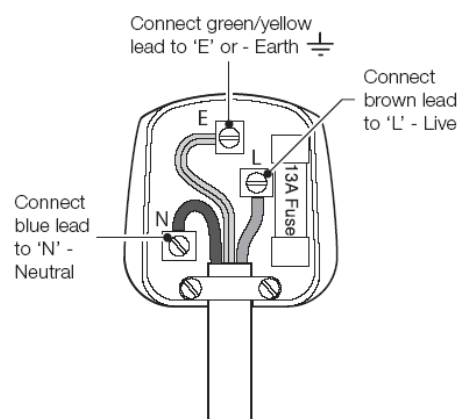

User Instructions

Before first use

Final checks before operating the appliance

1. Good air circulation around the appliance .
2. The feet have been adjusted for perfect levelling.
3. Clean the compartment per recommendation in section “Care and Maintenance”.
4. Plug in the appliance and the interior light will come on when the door is open.



The compressor starts up and in operation may produce some background noise .It is normal, this is not a defect.

Using your appliance



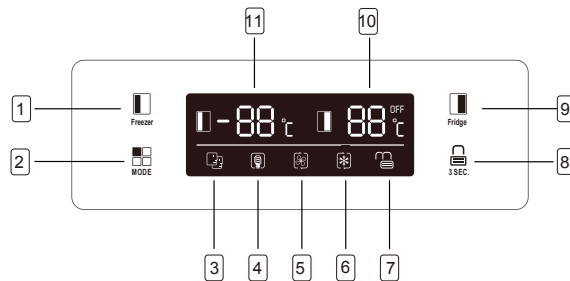

1. Control panel

- The control panel allows you to start and use all the functions of your refrigerator without opening the doors.



1. Freezer compartment temperature setting button
2. Function mode selection button
3. Smart mode indicator
4. Eco mode indicator
5. Super cooling indicator
6. Super freezing indicator
7. Safety lock indicator
8. Safety lock button
9. Fridge compartment temperature setting button
10. Fridge compartment temperature indicator
11. Freezer compartment temperature indicator

2. Safety lock function

- Lock:in standby state,press"8"  for 3 seconds or idle for 2 minutes will be auto lock, a beep will be heard denoting entering the Safety lock indicator "7"  will be illuminated.
- Unlock:in locked state,press"8"  for 1 second, a beep will be heard denoting that the lock is released and the indicator "7"  will go off.

3. Temperature adjustment

Once the appliance is connected to the mains, the display will turn on and the condition of the temperature setting will be $-18^{\circ}\text{C}/+5^{\circ}\text{C}$.

3.1 Setting the freezer compartment temperature

- To adjust the temperature in the freezer compartment, continue to press “  ” until the required temperature is reached,it allows adjustment between $-14^{\circ}\text{C}\sim-22^{\circ}\text{C}$.

3.2 Setting the fridge compartment temperature

- To adjust the temperature in the fridge compartment, continue to press “  ” until the required temperature is reached,it allows adjustment between $+2^{\circ}\text{C}\sim+8^{\circ}\text{C}$.
- If you choose "--" , the display will flash 5 seconds and then the fridge compartment will switch off. "OFF" will light on in the display window .

User Instructions

3.3 Pre-installed program mode

- 4 programs have been pre-installed into the appliance. You do not need to set the temperature of the compartment. To select the pre-installed program, continue to press the function mode selection button icon "MODE" (2) until the required program is reached and flash 5 seconds. The indicator for the selected mode will be illuminated.

Program mode	Display	Freezer temperature	Fridge temperature	Remarks
Smart mode		-15°C~-18°C	+3°C~+8°C	Adjust the temperature automatically against the operation environment
Eco Mode		-15°C	+8°C	Power save
Super cooling mode		Unchanged	+2°C	Return to previous setting after 2.5 hours
Super freezing mode		-25°C	Unchanged	Return to previous setting after 6hours
Normal mode		-14°C~-22°C	+2°C~+8°C	Default -18°C/+5°C . The temperature can be adjusted by customer

- To change the mode, continue to press "MODE" to change to the other mode.

4. Display

- When the door has been opened or any button has been pressed, the display will illuminate and stay on for around 2 minutes. This is normal.
- To check the current state, press any button on the control panel. It will then illuminate to show you the temperature of the compartments. The display will switch off after 2 minutes.

5. Storing fresh food

- Use the fridge compartment to store fresh food and drinks.
- Do not exceed the food capacity that the appliance is able to handle.
- Do not put warm food in the appliance immediately as it may cause excessive cooling of the compartment.
- Set the temperature knob at the medium position for storing fresh food.
- Do not mix already frozen food and fresh food.

6. Storing frozen food

- The freezer compartment is 4 Star rated and suitable for the freezing and storage of pre frozen food.
- Check the food packaging for suggestion before storage.

7. Thawing

Deep-frozen or frozen food, prior to be used, can be thawed in the fridge compartment or at room temperature, depending on the time available for this operation. Small pieces may even be cooked still frozen, directly from the freezer. In this case, cooking will take longer.

8. Ice-cube Tray

This appliance may be equipped with one or more ice-cube Tray to produce ice.

9. Movable compartment glass shelves

The walls of the refrigerator are equipped with a series of runners so that the shelves can be positioned as desired.

10. Positioning the door shelves

To permit storage of food packages of various sizes, the door balconies can be placed at different heights. To make these adjustments proceed as follows: gradually pull the balcony in the direction of the arrows until it comes free, then reposition as required.

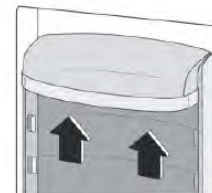
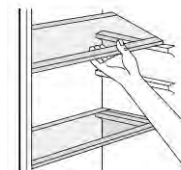

11. Door

The door should be closed as soon as possible after use. When the door is opened more than 90 seconds, an alarm will alert you for a few seconds, and it repeats each 30 seconds. The door is allowed to open at a maximum angle of 135°.

User Instructions

Useful information

The following guidelines and recommendations are suggested to obtain the best results and storage hygiene.

- Frequent door openings can cause internal temperature to rise so the door should be closed as soon as possible after use.
- For hygiene reasons, it is always a good practise to pack, wrap and cover the food before storing.
- Use a polythene bag to store raw meat and place on the lowest shelf. Avoid contact with cooked food to prevent contamination. For safety reasons, store raw meat for two to three days only.
- Cooked dishes must be stored in airtight covered containers.
- Food and beverages should cool to room temperature before storing.
- Most vegetables should be blanched and chilled before freezing.
- Bottles can be placed in the door section.
- Some fruits and vegetables like pineapples, melons, tomatoes, and cucumbers should be wrapped in polythene bags.
- Do not leave frozen food at room temperature to thaw. You could defrost the food by putting it in the fridge to thaw slowly. Make sure you avoid defrosting food dripping food juices onto other food.

Energy saving tips

- Place your fridge away from direct sunlight, your oven or any other heat sources. Allow 20 cm clear space on both sides and above, and at least 5 cm behind.
- Cover all food stored, and arrange it so that cold air can circulate freely.
- Higher cold setting will use more energy. Do not set to maximum cold if it is not necessary.
- Cool the hot/warm food to room temperature before putting them into your fridge.
- Frequently opening and closing the door would cause the internal temperature to rise and it will consume more energy.
- Close the door(s) properly, and make sure the seals and hinges are airtight. Check the seals by putting a sheet of paper between the door and the main body of the fridge. If the paper moves, your seals need replacing.
- Defrost regularly if your refrigerator is not a frost-free or cyclic defrost model. Accumulated ice layer should not be more than 5 mm thick.
- The pre-set combination of drawers, baskets and shelves have already been set in the most efficient way for use of this product.

Defrosting

Fridge Compartment

- The fridge compartment defrosts automatically. The defrosting water runs through the drain port to the drain tray at the back of the appliance.
- In the case, that some droplets may remain inside the compartment and re-freeze, after the defrosting cycle, this is normal. Do not use pointed or sharp objects, i.e. knives or forks, to remove the droplets which have frozen.
- Check the collection channel to ensure that no food particles have blocked the drain channel.

User Instructions

Defrosting

Freezer Compartment

To help you make the most of the freezing process, here are some important hints:

- the maximum quantity of food which can be frozen in 24 hrs. is shown on the rating plate;
- the freezing process takes 24 hours. No further food, to be frozen should be added during this period;
- only freeze top quality, fresh and thoroughly cleaned, foodstuffs;
- prepare food in small portions to enable it to be rapidly and completely frozen and to make it possible to thaw only the quantity required;
- wrap up the food in aluminium foil or polythene and make sure that the packages are airtight;
- do not allow fresh, unfrozen food to touch food which is already frozen, thus avoiding a rise in temperature of the latter;
- lean foods store better and longer than fatty ones; salt reduces the storage life of food;
- water ices, if consumed immediately after removal from the freezer compartment, can possibly cause the skin to be freeze burnt;
- removing items from the freezer compartment, can possibly cause the skin to be freeze burnt;
- it is advisable to show the freezing in date on each individual pack to enable you to keep tab of the storage time.

Care and Maintenance

General



Important: Always unplug the appliance from the power socket during cleaning and maintenance.

- Never use any sharp instruments or abrasive substances, soap, household cleaner, detergent or wax polish for cleaning.
- Use luke warm water to clean the cabinet of the appliance and wipe it dry.
- Never clean the appliance with flammable fluids. It could cause damage and a fire hazard.
- Clean the exterior of the appliance and door seal with a damp cloth and dry it through.
- Avoid water going in the temperature control box. Clean with a dry cloth only.
- Clean the condenser (located at the back of the appliance) with a vacuum cleaner. It is suggested to remove the dust every year.
- Shelves are all removable for cleaning.



Important: Care must be taken, while cleaning/carrying the appliance not to touch the bottom of the condenser metal wires at the back of the appliance, as this could cause injury to fingers and hands.

Light bulb replacement

This appliance is equipped with an LED light . It can be used for a long time. If the LED light is blown, it must be replaced by a qualified person to avoid any hazard. Contact the service agent at 0345 600 4632.

Power failure

In case there is a power failure, you should contact the electricity supply company and take the following actions:

If it is less than 24 hours, keep the doors closed. This will allow the stored food to stay cold as long as possible.

If it lasts more than 24 hours, it is advised to empty the freezer compartment and temporarily store the food in a portable freezer or using artificial ice packs. Try to use up the food which is more easily perishable.

Remarks: A full appliance will stay cold longer than a partially filled one.

If ice crystals are still visible on the food, it may be frozen again, although flavour and aroma may be affected. If food is found to be in a poor condition, it is best to throw it away.

Short vacation

There is no need to disconnect the appliance from the mains if you will be away for two to three weeks. Use up the perishable food.

Long vacation

Remove all the food if you are away for three weeks or more. Unplug the appliance and leave the doors open to provide air circulation to prevent odour and mould.

Care and Maintenance

Moving your appliance

Moving

Refer to section "Transportation" under "Installation"

Disassembly / assembly the door

- In case, there is problem with a door, you can contact the service agent for a replacement or you can replace it by yourself.
- The size of the doors are, Freezer 395mm(W)x1714mm(H) and Fridge 500mm(W)x1714mm(H).



Warning: 2 people may be required to re-align the door.

- A Philips screw driver will be required for this task.
- Put a protective layer on the floor before taking off the door.

To disassemble the door.

1. Unscrew the screw fixing the top hinge cover (Fig.a).
2. Remove the top hinge cover (Fig.b).
3. Unscrew the screw that secures the top hinge (Fig.c)
4. Press on the lock of the cable connector (Fig.d) and separate the lead wire (Fig.e).
5. One person should hold the door.
6. Remove the top hinge (Fig.f) from the door. Take care of the lead wire to avoid any damage to the wire.
7. Move the door upward to release it from the bottom hinge (Fig.g&h)
8. Lay the door on the floor on a protective layer to avoid making scratching the surface.



Fig.a

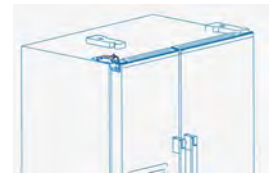

Fig.b

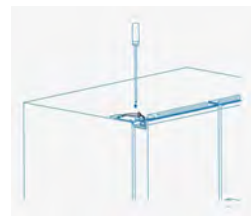

Fig.c



Fig.d



Fig.e



Fig.f



Fig.g



Fig.h

To assemble the door

1. Carefully lift the door. Align the hole in the lower corner of the door over the lower hinge. Lower the door onto the lower hinge.
2. Insert the upper hinge into the hole on the upper edge of the door.
3. One person should hold the door in place.
4. Make sure the hinge is level between the upper hinge hole and the hole on the top of the cabinet.
5. Reattach the hinge screws to secure the door.
6. Reconnect the lead wires and refit the top hinge cover. Reattach the hinge cover with the screw.

Trouble Shooting

- In the unlikely event of difficulties with your appliance please follow the trouble shooting guide below. If the problem persists, contact an approved service agent on 0345 600 4632.
- To contact the service agent, please tell them the serial no. It can be found on the back of this manual or at the back of the fridge freezer.

Problem	Possible cause	Solution
Appliance does not start	<ul style="list-style-type: none"> • The mains plug is not plugged in. • Protection devices or fuses of the electrical system at home have switched off 	<ul style="list-style-type: none"> • Insert the mains plug. • Check the protection devices and fuses.
Light does not work	<ul style="list-style-type: none"> • LED PCB defective 	<ul style="list-style-type: none"> • Call service centre
Appliance not cool enough	<ul style="list-style-type: none"> • Cooling system has not settled after transportation • Doors not closed properly • Doors frequently opened • Loading too much food • Low temperature setting • Door seal dirty or sticky 	<ul style="list-style-type: none"> • Leave the appliance at least 4 hours before switching on • Check any food blockage • Reduce the frequency • Reduce the food quantity • Adjust the temperature knob • Clean per section "Care and Maintenance"
Food frozen in fridge compartment	<ul style="list-style-type: none"> • High temperature setting 	<ul style="list-style-type: none"> • Adjust the temperature knob
Noisy appliance	<ul style="list-style-type: none"> • Not positioned on an even surface • Appliance is touching objects around it • Bottles and containers are contacting with each other 	<ul style="list-style-type: none"> • Install on even surface and levelling the appliance • Ensure spacing at both sides and above the appliance • Separate them
Appliance moves when you open the door	<ul style="list-style-type: none"> • Did not fix the levelling feet at the front 	<ul style="list-style-type: none"> • Adjust the feet at the front to lock and level the appliance

Technical Specifications

Model	BSBSFFSS BSBSFFB
Energy efficiency class	A+
Energy consumption – Kwh/year	401
Net storage – volume fresh food (litres)	345
Net storage – volume frozen food (litres)	172
Total net storage (litres)	517
Frozen food compartment rating	4 Star 
Climate class	N/ST
Operating noise level dB(A)	43
Minimum Operation Temperature	10 °C

We apologise for any inconvenience caused by any minor inconsistencies in these instructions, which may occur as a result of product improvements and development.



This appliance complies with the following EEC directives:
2006/95/EEC Low voltage directive
2004/108/EEC EMC directive

Disposal information



The symbol on the product or its packaging indicates that this product may not be treated as household waste. Instead it should be handed over to the applicable collection point for the recycling of electrical and electronic equipment. By ensuring this product is disposed of correctly, you will help prevent potential negative consequences for the environment and human health, which could otherwise be caused by inappropriate waste handling of this product. For more detailed information about recycling this product, please contact your local council office, your household waste disposal service or the shop where the product was purchased.

Remember: Old fridges must be disposed of carefully - older models contain CFC gases that are harmful - if in doubt, contact your local council for details on how to dispose of an old fridge.



PRODUCT GUARANTEE

This product is guaranteed against manufacturing defects for a period of



Year

This product is guaranteed for twenty four months from the date of original purchase.

Any defect that arises due to faulty materials or workmanship will either be replaced, refunded or repaired free of charge where possible during this period by the dealer from whom you purchased the unit.

The guarantee is subject to the following provisions:

- The guarantee does not cover accidental damage, misuse, cabinet parts, knobs or consumable items.
- The product must be correctly installed and operated in accordance with the instructions contained in this manual.
- It must be used solely for domestic purpose.
- The guarantee will be rendered invalid if the product is re-sold or has been damaged by inexpert repair.
- Specifications are subject to change without notice.
- The manufacturer disclaims any liability for the incidental or consequential damages.
- The guarantee is in addition to, and does not diminish your statutory or legal rights.
- In the event of a problem with the product within the guarantee period call the Customer Helpline on 0345 600 4632.

Guarantor: Argos Ltd
489 - 499 Avebury Boulevard
Central Milton Keynes
MK9 2NW