

# HOH CAMBRIA SMALL SIDEBOARD

Assembly Instructions - Please keep for future reference

335/9930

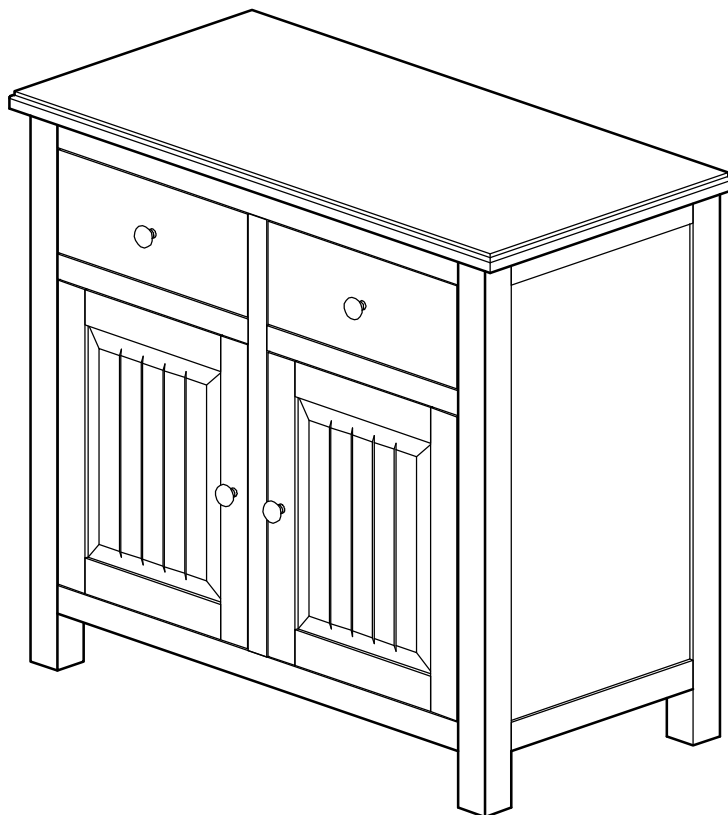

## Dimensions

Width - 90cm  
Depth - 45cm  
Height - 80cm

**Important** - Please read these instructions fully before starting assembly

If you need help or have damaged or missing parts, call the **Customer Helpline:**  
**Argos = 0845 6400800**



## Safety and Care Advice

**Important - Please read these instructions fully before starting assembly**

- Check you have all the components and tools listed on pages 2 and 3.
- Remove all fittings from the plastic bags and separate them into their groups.
- Keep children and animals away from the work area, small parts could choke if swallowed.
- Make sure you have enough space to layout the parts before starting.

- Do not stand or put weight on this product during assembly, this could cause damage.
- Assemble the item as close to its final position (in the same room) as possible.
- Assemble on a soft level surface to avoid damaging the unit or your floor.
- Parts of the assembly will be easier with 2 people.

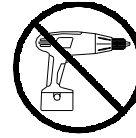

- To reduce the likelihood of damaging your product please ensure that your power drill is set on a low torque setting.

### Care and maintenance

- Only clean using a damp cloth and mild detergent, do not use bleach or abrasive cleaners.
- From time to time check that there are no loose screws on this unit.
- This product should not be discarded with household waste. Take to your local authority waste disposal centre.

### Handy Hints

- Assemble all parts and bolts loosely during assembly, only once the product is complete should you fully tighten the bolts
- Regularly check and ensure that all bolts and fittings are tightend properly.

**Note:** if required the next page can be cut out and used as reference throughout the assembly. Keep this page with these instructions for future reference.

# Components - Panels

If you have damaged or missing components,  
call the **Customer Helpline: 0845 6400800**

Please check you have all the panels listed below

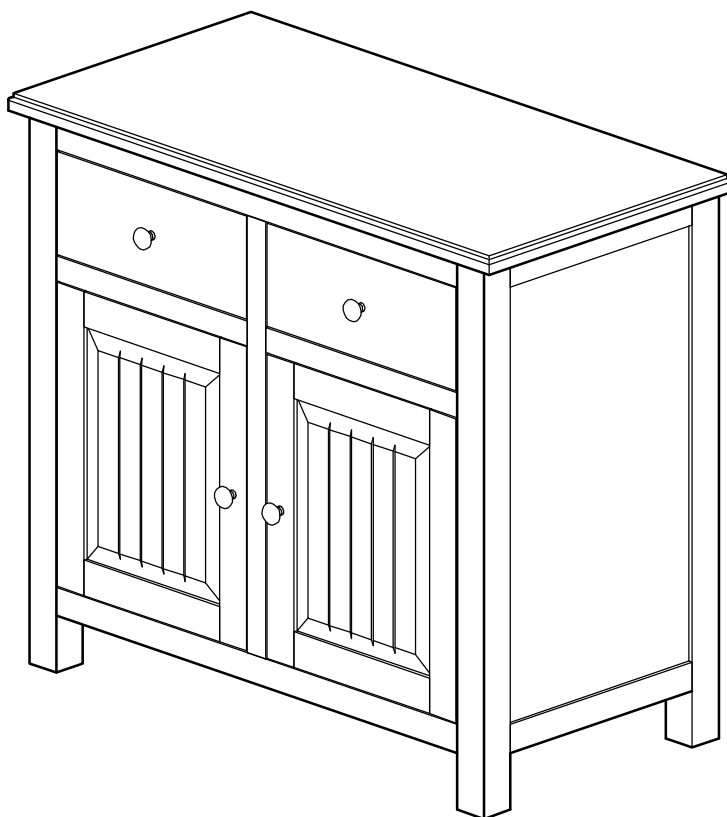



**1** Small Sideboard (90x45x80 cm)



# Components - Fittings

Please check you have all the fittings listed below

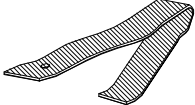
**Note:** The quantities below are the correct amount to complete the assembly. In some cases more fittings may be supplied than are required.

<p><b>A</b></p>  <p>Wall strap x 1</p>	<p><b>B</b></p>  <p>Ø12x1mm Washer x 1</p>	<p><b>C</b></p>  <p>Ø3.5x15 mm Screw x 1</p>
---	---	---

## Tools required

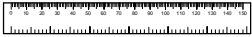

Ruler/tape  
measure

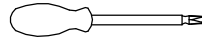

Philips screwdriver  
(medium & large)

## Ruler - Use this ruler to help correctly identify the screws

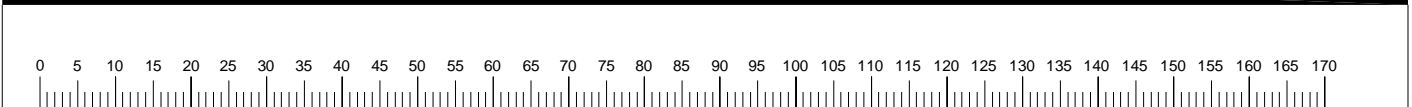

The screws length is measured from the head to the point (30mm screw shown).

# Assembly Instructions

## Step 1

### Fixing strap to wall.

It is recommended that the unit is fixed to a wall.

Mark fixing hole on wall, making sure there is enough space to the left and right of the wall strap for the sideboard.

Fasten wall strap **A** to the wall using a suitable wall screw/plug system.



**Warning:** Before drilling, check wall for hidden pipes and cables.

**Note:** The correct type of wall screws must be used for your wall. Please seek professional advice if in doubt.

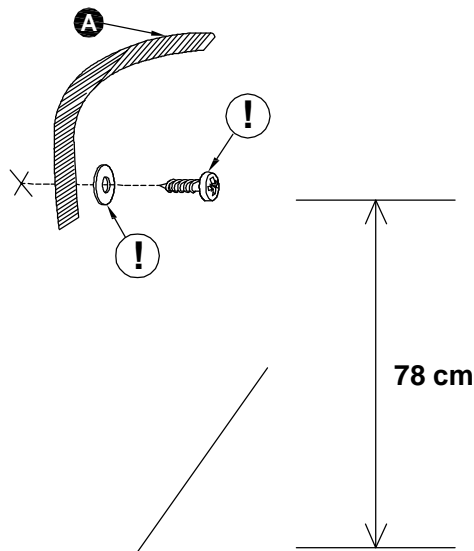

## Step 2

### Fixing unit to wall.

With the help of another person move the unit into position.

Place the wall strap on the top of the unit.

Fasten the wall strap to the unit with screw **C** and washer **B**.

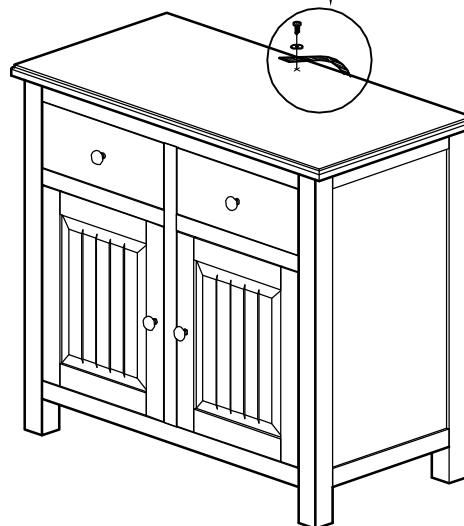
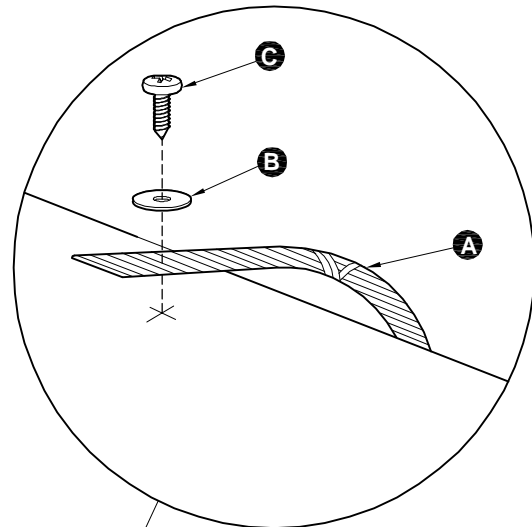

**Assembly is complete.**

If you need help or have damaged or missing parts, call the Customer Helpline: 0845 640 0800