



WF80F5****	WF70F5****	WF60F4****
WF81FE****	WF71F5****	WF61F4****
WF82F5****	WF72F5****	WF62F4****
WF8AF5****	WF7AF5****	WF6AF4****

Washing machine

User manual

imagine the possibilities

Thank you for purchasing this Samsung product.
To receive a more complete service, please register
your product at

www.samsung.com/register



■ Contents

Safety information	4
What you need to know about the safety instructions	4
Important safety symbols	4
What the icons and signs in this user manual mean:.....	4
Important safety precautions	5
Instructions about the WEEE	10
Setting up your washing machine	11
Checking the parts.....	11
Meeting the installation requirements.....	12
Electrical supply and grounding	12
Water supply	12
Drain	13
Flooring	13
Surrounding temperature	13
Alcove or closet installation	13
Installing your washing machine	14
Using your washing machine	19
Detergent and Additives Information.....	19
Using the proper detergent.....	19
Using the detergent drawer	19
Using liquid detergent (selected models)	20
Doing laundry for the first time.....	21
Basic instructions	21
Using the control panel	22
Using the Cycle Selector	24
Child Lock	25
Sound Off	25
Delay End	25
Smart Check	26
Doing laundry	27
Doing laundry using the Cycle Selector	27
Doing laundry manually	28
Laundry guidelines	28

Cleaning your washing machine 30

Eco Drum Clean	30
Cleaning procedures	30
Eco Drum Clean auto alarm function	30
Draining the washing machine in an emergency	31
Cleaning the debris filter	32
Cleaning the exterior	32
Cleaning the detergent drawer and drawer recess	33
Cleaning the mesh filter	33

Maintaining your washing machine 34

Repairing a frozen washing machine	34
Storing your washing machine	34

Troubleshooting and information codes 35

Check these points if your washing machine... ..	35
Information codes	36

Cycle chart 37

Cycle chart	37
-------------------	----

Appendix 38

Fabric care chart	38
Protecting the environment	38
Declaration of conformity	38
Sheet of household washing machines	39
Information of main washing programmes	42

■ Safety information

Congratulations on your new Samsung washing machine. This manual contains important information on the installation, use and care of your appliance. Please take some time to read this manual to take full advantage of your washing machine's many benefits and features.

What you need to know about the safety instructions



Please read this manual thoroughly to ensure that you know how to safely and efficiently operate the extensive features and functions of your new appliance. Please store the manual in a safe location close to the appliance for future reference. Use this appliance only for its intended purpose as described in this instruction manual.

Warnings and Important Safety Instructions in this manual do not cover all possible conditions and situations that may occur. It is your responsibility to use common sense, caution and care when installing, maintaining and operating your washing machine.

Because the following operating instructions cover various models, the characteristics of your washing machine may differ slightly from those described in this manual and not all warning signs may be applicable. If you have any questions or concerns, contact your nearest service centre or find help and information online at www.samsung.com.

Important safety symbols

■ What the icons and signs in this user manual mean:

	WARNING: Hazards or unsafe practices that may result in severe personal injury, death and/or property damage.
	CAUTION: Hazards or unsafe practices that may result in personal injury and/or property damage.
	NOTE

These warning signs are here to prevent injury to yourself and others.

Please follow them explicitly.

After reading this manual, store it in a safe place for future reference.

Read all instructions before using the appliance.

As with any equipment that uses electricity and moving parts, potential hazards exist. To safely operate this appliance, familiarize yourself with its operation and exercise care when using it.

Important safety precautions

⚠ WARNING: To reduce the risk of fire, electric shock, or injury to persons when using your appliance, follow basic precautions, including the following:

Do not let children (or pets) play in or on your washing machine. The washing machine door does not open easily from the inside and children may be seriously injured if trapped inside.

This appliance is not to be used by persons (including children) with reduced physical, sensory or mental capabilities, or lack of experience and knowledge, unless they have been given supervision or instruction concerning use of the appliance by a person responsible for their safety.

Children should be supervised to ensure that they do not play with the appliance.

For use in Europe: This appliance can be used by children aged from 8 years and above and persons with reduced physical, sensory or mental capabilities or lack of experience and knowledge if they have been given supervision or instruction concerning use of the appliance in a safe way and understand the hazards involved. Children shall not play with the appliance. Cleaning and user maintenance shall not be made by children without supervision.

If the supply cord is damaged, it must be replaced by the manufacturer, its service agent or similarly qualified persons in order to avoid a hazard.

This appliance should be positioned so that the power plug, the water supply taps, and the drain pipes are accessible.

For appliances with ventilation openings in the base, that a carpet must not obstruct the openings.

The new hose-sets supplied with the appliance are to be used and that old hose-sets should not be reused.

CAUTION: In order to avoid a hazard due to inadvertent resetting of the thermal cut-out, this appliance must not be supplied through an external switching device, such as a timer, or connected to a circuit that is regularly switched on and off by the utility.

WARNING: Critical installation WARNINGS

The installation of this appliance must be performed by a qualified technician or service company.

- Failure to do so may result in electric shock, fire, an explosion, problems with the product, or injury.

The appliance is heavy, therefore take care when lifting it.

Plug the power cord into an AC 220 - 240 V / 50 Hz wall socket or higher and use the socket for this appliance only. Never use an extension cord.

- Sharing a wall socket with other appliances using a power strip or extending the power cord may result in electric shock or fire.
- Ensure that the power voltage, frequency, and current are the same as those of the product specifications. Failure to do so may result in electric shock or fire. Plug the power plug into the wall socket firmly.

Remove all foreign substances such as dust or water from the power plug terminals and contact points using a dry cloth on a regular basis.

- Unplug the power plug and clean it with a dry cloth.
- Failure to do so may result in electric shock or fire.

Plug the power plug into the wall socket so that the cord is running towards the floor.

- If you plug the power plug into the socket in the opposite direction, the electric wires within the cable may be damaged and this may result in electric shock or fire.

Keep all packaging materials out of the reach of children as these may be dangerous.

- If a child places a bag over its head, it may suffocate.

When the appliance, power plug or power cord is damaged, contact your nearest service centre.

This appliance must be properly grounded.

Do not ground the appliance to a gas pipe, plastic water pipe, or telephone line.

- This may result in electric shock, fire, an explosion, or problems with the product.
- Never plug the power cord into a socket that is not grounded correctly and make sure that it is in accordance with local and national regulations.

Do not install this appliance near a heater or any inflammable material.

Do not install this appliance in a humid, oily or dusty location, or in a location exposed to direct sunlight or water (rain drops).

Do not install this appliance in a location exposed to low temperatures.

- Frost may cause the tubes to burst.

Do not install this appliance in a location where gas may leak.

- This may result in electric shock or fire.

Do not use an electric transformer.

- This may result in electric shock or fire.

Do not use a damaged power plug, damaged power cord, or loose wall socket.

- This may result in electric shock or fire.

Do not pull or excessively bend the power cord.

Do not twist or tie the power cord.

Do not hook the power cord over a metal object, place a heavy object on the power cord, insert the power cord between objects, or push the power cord into the space behind the appliance.

- This may result in electric shock or fire.

Do not pull the power cord when unplugging the power plug.

- Unplug the power plug by holding the plug.
- Failure to do so may result in electric shock or fire.

CAUTION: Installation CAUTIONS

This appliance should be positioned in such a way that the power plug is easily accessible.

- Failure to do so may result in electric shock or fire due to electric leakage.

Install your appliance on a solid, level floor that can support its weight.

- Failure to do so may result in abnormal vibrations, movement, noise, or problems with the product.

WARNING: Critical usage WARNINGS

If the appliance is flooded, turn off the water & power supplies immediately and contact your nearest service centre.

- Do not touch the power plug with wet hands.
- Failure to do so may result in electric shock.

If the appliance generates a strange noise, a burning smell, or smoke, unplug the power plug immediately and contact your nearest service centre.

- Failure to do so may result in electric shock or fire.

In the event of a gas leak (such as propane gas, LP gas, etc.), ventilate immediately without touching the power plug. Do not touch the appliance or power cord.

- Do not use a ventilating fan.
- A spark may result in an explosion or fire.

Do not let children play in or on the washing machine. In addition, when disposing of the appliance, remove the washing machine door lever.

- If trapped inside the product, children may suffocate to death.

Make sure to remove the packaging (sponge, styrofoam) attached to the bottom of the washing machine before using it.

Do not wash items contaminated with gasoline, kerosene, benzene, paint thinner, alcohol or other inflammable or explosive substances.

- This may result in electric shock, fire, or an explosion.

Do not open the washing machine door by force while it is operating (high-temperature washing/drying/spinning).

- Water flowing out of the washing machine may result in burns or cause the floor to be slippery. This may result in injury.
- Opening the door by force may result in damage to the product or injury.

Do not insert your hand under the washing machine while an operation is in progress.

- This may result in injury.

Do not touch the power plug with wet hands.

- This may result in electric shock.

Do not turn the appliance off by unplugging the power plug while an operation is in progress.

- Plugging the power plug into the wall socket again may cause a spark and result in electric shock or fire.

Do not let children or the infirm use this washing machine without proper supervision. Do not let children climb in or onto the appliance.

- This may result in electric shock, burns or injury.

Do not insert your hand or a metal object under the washing machine while it is operating.

- This may result in injury.

Do not unplug the appliance by pulling the power cord. Always grip the plug firmly and pull it straight out of the outlet.

- Damage to the power cord may cause a short-circuit, fire and/or electric shock.

Do not attempt to repair, disassemble, or modify the appliance yourself.

- Do not use a fuse (such as copper, steel wire, etc.) other than a standard fuse.
- When the appliance needs to be repaired or reinstalled, contact your nearest service centre.
- Failure to do so may result in electric shock, fire, problems with the product, or injury.

If the water supply hose comes loose from the water tap and floods the appliance, unplug the power plug.

- Failure to do so may result in electric shock or fire.

Unplug the power plug when the appliance is not being used for long periods of time or during a thunder or lightning storm.

- Failure to do so may result in electric shock or fire.

If any foreign substance enters into the appliance, unplug the power plug and contact you nearest Samsung Customer Service.

- This may result in electric shock or fire.

CAUTION: Usage CAUTIONS

When the washing machine is contaminated by a foreign substance such as detergent, dirt, food waste, etc., unplug the power plug and clean the washing machine using a damp, soft cloth.

- Failure to do so may result in discolouration, deformation, damage, or rust.

The front glass may be broken by a strong impact. Take care when using the washing machine.

- If the glass is broken, it may result in injury.

After a water supply failure or when reconnecting the water supply hose, open the water tap slowly.

Open the water tap slowly after a long period of non-use.

- The air pressure in the water supply hose or the water pipe may damage a product part or result in a water leak.

If a draining error occurs during an operation, check if there is a draining problem.

- If the washing machine is used when it is flooded because of a draining problem, it may result in electric shock or fire.

Insert the laundry into the washing machine completely so that the laundry does not get caught in the door.

- If laundry gets caught in the door, it may result in damage to the laundry or the washing machine, or result in a water leak.

Turn the water supply off when the washing machine is not being used.

Ensure that the screws on the water supply hose connector are properly tightened.

- Failure to do so may result in property damage or injury.

Ensure that the rubber seal and front door glass are not contaminated by a foreign substance (e.g. waste, thread, hair, etc.).

- If a foreign substance is caught in the door or the door is not completely closed, it may cause a water leak.

Open the water tap and check if the water supply hose connector is firmly tightened and that there is no water leak before using the product.

- If the screws on the water supply hose connector are loose, it may result in a water leak.

The product you have purchased is designed for domestic use only.

Using the product for business purposes qualifies as a product misuse. In this case, the product will not be covered by the standard warranty provided by Samsung and no responsibility can be attributed to Samsung for malfunctions or damages resulting from such misuse.

Do not stand on the appliance or place objects (such as laundry, lighted candles, lighted cigarettes, dishes, chemicals, metal objects, etc.) on the appliance.

- This may result in electric shock, fire, problems with the product, or injury.

Do not spray volatile material such as insecticide onto the surface of the appliance.

- As well as being harmful to humans, this may result in electric shock, fire or problems with the product.

Do not place objects that generate electromagnetic fields near the washing machine.

- This may result in injury due to a malfunction.

Water drained during a high-temperature wash or drying cycle is hot. Do not touch the water.

- This may result in burns or injury.

Do not wash, spin, or dry water-proof seats, mats, or clothing (*) unless your appliance has a special cycle for washing these items.

(*): Woollen bedding, rain covers, fishing vests, ski pants, sleeping bags, diaper covers, sweat suits, and bicycle, motor cycle and car covers, etc.

- Do not wash thick or hard mats even if the washing machine mark is on the care label. This may result in injury or damage to the washing machine, walls, floor, or clothing due to abnormal vibrations.
- Do not wash throw rugs or doormats with rubber backing. The rubber backing may come off and stick to inside the drum, and this may result in malfunction such as a drainage error.

Do not operate the washing machine when the detergent drawer is removed.

- This may result in electric shock or injury due to a water leak.

Do not touch the insides of the drum during or just after drying as it is hot.

- This may result in burns.

Do not insert your hand into the detergent drawer.

- This may result in injury as your hand may be caught by the detergent input device.

Do not place any objects (such as shoes, food waste, animals) other than laundry into the washing machine.

- This may result in damage to the washing machine, or injury and death in the case of pets due to the abnormal vibrations.

Do not press the buttons using sharp objects such as pins, knives, fingernails, etc.

- This may result in electric shock or injury.

Do not wash laundry contaminated by oils, creams or lotions usually found in skincare shops or massage clinics.

- This may cause the rubber seal to become deformed and result in a water leak.

Do not leave metal objects such as safety pins, hair pins or bleach in the drum for long periods of time.

- This may cause the drum to rust.
- If rust starts appearing on the surface of the drum, apply a (neutral) cleansing agent to the surface and use a sponge to clean it. Never use a metal brush.

Do not use dry cleaning detergent directly and do not wash, rinse, or spin laundry contaminated by dry cleaning detergent.

- This may result in spontaneous combustion or ignition due to the heat from the oxidation of the oil.

Do not use water from water cooling/heating devices.

- This may result in problems with the washing machine.

Do not use natural hand-washing soap for the washing machine.

- If it hardens and accumulates inside the washing machine, it may result in problems with the product, discolouration, rust, or bad odours.

Place socks and brassieres in a washing net and wash them with the other laundry.

Do not wash large laundry items such as bedding in the washing net.

- Failure to do so may result in injury due to abnormal vibrations.

Do not use hardened detergent.

- If it accumulates inside the washing machine, it may result in a water leak.

Make sure that the pockets of all the clothing items to be washed are empty.

- Hard, sharp objects such as coins, safety pins, nails, screws, or stones can cause extensive damage to the appliance.

Do not wash clothing with large buckles, buttons or other heavy metal objects.

Sort the laundry by color on the basis of its colorfastness and select the recommended cycle, water temperature and additional functions.

- This may result in discoloration or fabric damage.

Take care that children's fingers are not caught in the door when you close it.

- Failure to do so may result in injury.

⚠ WARNING: Critical cleaning WARNINGS

Do not clean the appliance by spraying water directly onto it.

Do not use the a strong acidic cleaning agent.

Do not use benzene, thinner or alcohol to clean the appliance.

- This may result in discolouration, deformation, damage, electric shock or fire.

Before cleaning or performing maintenance, unplug the appliance from the wall socket.

- Failure to do so may result in electric shock or fire.

Instructions about the WEEE



Correct Disposal of This Product (Waste Electrical & Electronic Equipment) (Applicable in countries with separate collection systems)

This marking on the product, accessories or literature indicates that the product and its electronic accessories (e.g. charger, headset, USB cable) should not be disposed of with other household waste at the end of their working life. To prevent possible harm to the environment or human health from uncontrolled waste disposal, please separate these items from other types of waste and recycle them responsibly to promote the sustainable reuse of material resources.

Household users should contact either the retailer where they purchased this product, or their local government office, for details of where and how they can take these items for environmentally safe recycling.

Business users should contact their supplier and check the terms and conditions of the purchase contract. This product and its electronic accessories should not be mixed with other commercial wastes for disposal.

Setting up your washing machine

Be sure to have your installer follow these instructions closely so that your new washing machine works properly, and that you're not at risk of injury when doing laundry.

Checking the parts

Carefully unpack your washing machine, and make sure you've received all of the parts shown below. If your washing machine was damaged during shipping or if you do not have all of the parts, contact the Samsung Customer Service or your Samsung dealer.

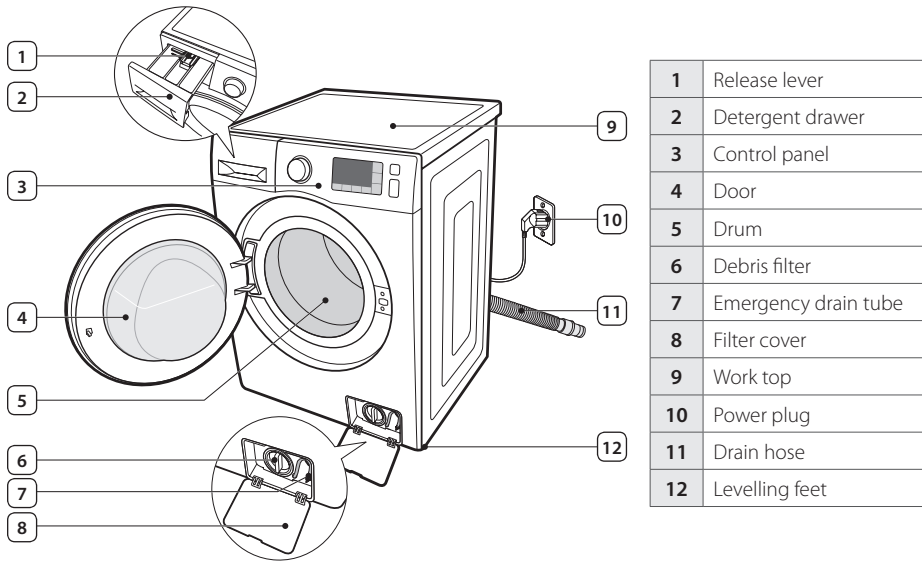

Wrench
(selected models)



Bolt hole covers *

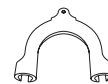

Hose guide



Cold water supply hose



Hot water supply hose
(selected models)

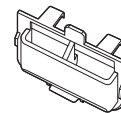

Liquid detergent guide



Bolt hole covers *: The number of bolt hole covers depends on the model (3 to 5 covers).

Meeting the installation requirements

Electrical supply and grounding

 **WARNING:** Never use an extension cord.

Use only the power cord that comes with your washing machine.

When preparing the installation, ensure that your power supply offers:

- An AC 220 - 240 V / 50 Hz fuse or circuit breaker
- An individual branch circuit dedicated to your washing machine

Your washing machine must be grounded. If your washing machine malfunctions or breaks down, grounding will reduce the risk of electric shock by providing a path of least resistance for the electric current. Your washing machine comes with a power cord that has a three-prong grounding plug for use in a properly installed and grounded outlet.

 **WARNING:** Never connect the ground wire to plastic plumbing lines, gas lines, or hot water pipes.

Improperly connecting the equipment-grounding conductor can result in electric shock. Check with a qualified electrician or serviceman if you are unsure if the washing machine is properly grounded.

 **CAUTION:** Do not modify the plug provided with the washing machine. If it does not fit the outlet, have a proper outlet installed by a qualified electrician.

Water supply

Your washing machine will fill properly when your water pressure is between 50 kPa to 800 kPa. A water pressure less than 50 kPa may cause a water valve failure and not allow the water valve to shut off completely. Alternatively, the washing machine controls may not handle the pressure and cause the washing machine to turn off. (A fill-time limit has been built into the controls, designed to prevent overflows or flooding if an internal hose becomes loose.)

The water taps must be within 120 cm of the back of your washing machine for the provided water supply hoses to reach your washing machine.

 Most plumbing supply stores sell water supply hoses of various lengths up to 305cm long.

 You can reduce the risk of leaks and water damage by:

- Making water taps easily accessible.
- Turning off water taps when the washing machine is not in use.
- Periodically checking the water supply hose fittings for leaks.

 **WARNING:** Before using your washing machine for the first time, check all connections at the water valve and taps for leaks.

Drain

Samsung recommends a standpipe height of 65 cm. The drain hose must be routed through the drain hose clip to the standpipe. The standpipe must be large enough to accept the outside diameter of the drain hose. The drain hose is attached at the factory.

Flooring

For best performance, your washing machine must be installed on a solidly constructed floor. Wooden floors may need to be reinforced to minimize vibrations and/or unbalanced loads. Carpeting and soft tile surfaces are contributing factors to vibrations and the tendency for your washing machine to move slightly during the spin cycle.

⚠ WARNING: Never install your washing machine on a platform or poorly supported structure.

Surrounding temperature

Do not install your washing machine in areas where water may freeze, since your washing machine always retains some water in the water valve, pump, and hose areas. Frozen water in the lines can cause damage to the belts, the pump, and other components.

Alcove or closet installation

To operate safely and properly, your new washing machine requires the following minimum clearances:

Sides	25 mm
Top	25 mm
Rear *	50 mm
Front	500 mm

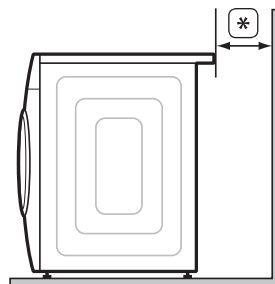

If both the washing machine and a dryer are installed together, the front of the alcove or closet must have an unobstructed air opening of at least 500 mm. Your washing machine by itself does not require a specific air opening.

Installing your washing machine

⚠ CAUTION: Do not plug the power cord into a wall socket before the installation is complete.

⚠ WARNING: Packaging materials can be dangerous to children; keep all packaging material (plastic bags, polystyrene, etc.) well out of the reach of children.

STEP 1 - Selecting a location

-  Before you install the washing machine, make sure the location:
- Has a hard, level surface without carpeting or flooring that may obstruct ventilation
 - Is away from direct sunlight
 - Has adequate ventilation
 - Is not exposed to freezing temperatures (below 0 °C)
 - Is away from heat sources such as oil or gas
 - Has enough space so that the washing machine doesn't stand on its power cord

STEP 2 - Removing the shipping bolts

Before installing the washing machine, you must remove all shipping bolts from the back of the unit.

1. Loosen all the bolts with the wrench.

(*): Optional

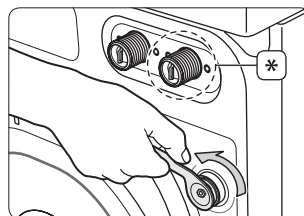

2. Hold the shipping bolt with your hand and pull it through the wide section of the hole. Repeat for each shipping bolt.

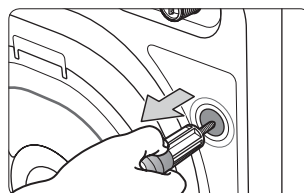

3. Fill the holes with the supplied bolt hole covers.
4. Store all shipping bolts in a safe location where they can be easily retrieved in the event that you have to move the washing machine.

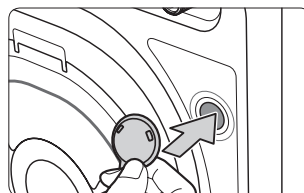

STEP 3 - Adjusting the levelling feet

 When installing your washing machine, ensure that the power plug, the water supply, and the drain are easily accessible.

1. Slide the washing machine into position.
2. Loosen all the lock nuts with the wrench.

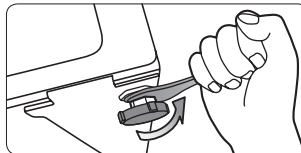

3. Level your washing machine by turning the levelling feet in and out as necessary by hand.

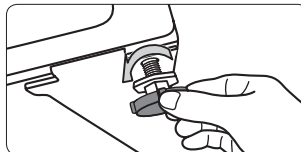

4. When your washing machine is level, tighten the lock nuts using the wrench.

 **CAUTION:** Do not move your washing machine unless you tighten the lock nuts. This may result in damage to the leveling feet.

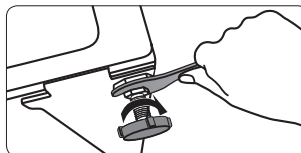

STEP 4 - Connecting the water and the drain

Connecting the water supply hose

 **WARNING:** Do not connect multiple water supply hoses. This may result in a water leak and electric shock due to the water leak. If the hose is too short, replace the hose with a longer, high pressure hose.

1. Connect the L-shaped arm fitting for the cold water supply hose to the cold water supply intake at the back of the machine. Then tighten it by turning **part (A)** clockwise by hand.

(*): Optional

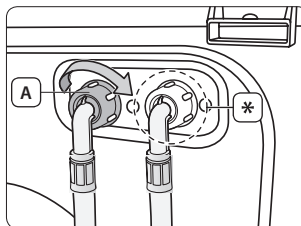

2. Remove the **adaptor (B)** from the other end of the **water supply hose (C)**.

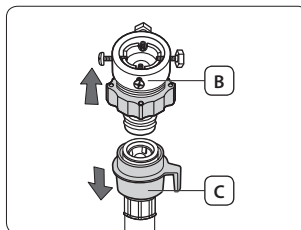

3. First, loosen the four screws on the adaptor using a '+' type screwdriver. Next, hold **part (D)** and turn **part (E)** following the arrow until there is a 5 mm gap.

(*): 5 mm

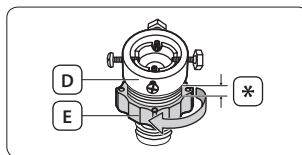

4. Connect the adaptor to the water tap by tightening all the screws firmly while lifting the adaptor upwards.

Then tighten the adaptor by turning **part (E)** following the arrow.

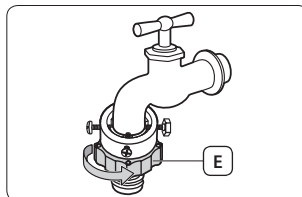

5. Connect the water supply hose to the adaptor. If you push **part (F)** into the adaptor, the hose automatically connects to the adaptor with a 'clicking' sound.



After you have connected the water supply hose to the adaptor, ensure that it is connected correctly by pulling the water supply hose downwards.



WARNING: Check if the water supply hose is not twisted or bent. If the hose is twisted or bent, there is a danger of a water leak and electric shock due to the water leak.

If necessary, you can reposition the water supply hose at the washing machine end by loosening the L-shaped arm fitting, rotating the hose, and retightening the L-shaped arm fitting.

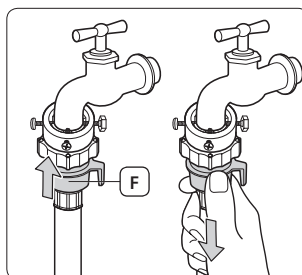

6. Turn on the water supply and ensure that there are no water leaks from the water valve, tap, or adaptor. If there is a water leak, repeat the previous steps.



WARNING: Do not use your washing machine if there is a water leak. This may result in electric shock or injury.

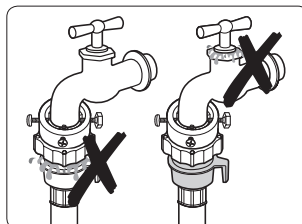

If the water tap has a screw type tap, connect the water supply hose to the tap as shown.

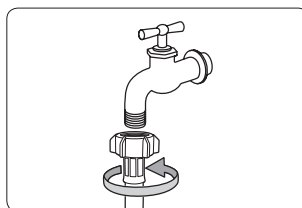

Use the most conventional type of tap for the water supply. If the tap is square or too big, remove the spacing ring before inserting the tap into the adaptor.

Connecting the hot water supply hose (selected models)

1. Connect the **red L-shaped arm fitting (A)** for the hot water supply hose to the hot water supply intake at the back of the machine. Then tighten it by hand.
2. Connect the other end of the hot water supply hose to your sink's hot water tap in the same way as you connected the cold water supply hose.



To use only cold water, use the Y-piece.

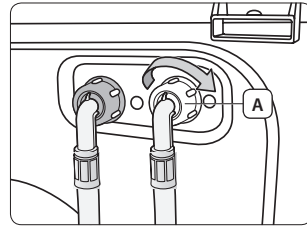

Connecting the aqua hose (selected models)

The aqua hose was invented to ensure perfect leakage protection. The aqua stop is attached to the aqua hose and automatically cuts the water flow if the hose is damaged.

It also displays a **warning indicator (A)** on the aqua stop.

Connect the aqua hose by assembling the aqua stop on the tap as shown.

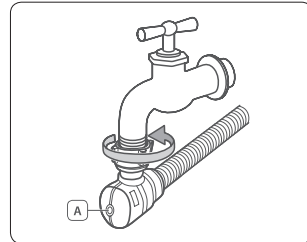

Connecting the drain hose

The end of the drain hose can be positioned in three ways:

Over the edge of a wash basin

The drain hose must be placed at a height between 60 cm and 90 cm. To keep the drain hose spout bent, use the supplied **plastic hose guide (A)**. Secure the guide to the wall with a hook or to the tap with a piece of string to prevent the drain hose from moving.

(*): 60 ~ 90 cm

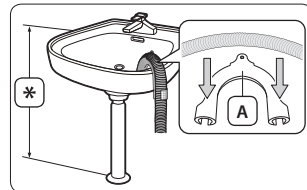

In a sink drain pipe branch

The drain pipe branch must be above the sink siphon so that the end of the hose is at least 60 cm above the ground.

In a standpipe

We recommend using a 65 cm high vertical pipe as a standpipe. It must be no shorter than 60 cm and no longer than 90 cm. To keep the drain hose spout bent, use the supplied **plastic hose guide (A)**. Secure the drain hose to the standpipe with tie straps to prevent the drain hose from moving.



The standpipe drain requires:

- A minimum diameter of 5 cm.
- A minimum carry-away capacity of 60 litres per minute.

(*): 60 ~ 90 cm

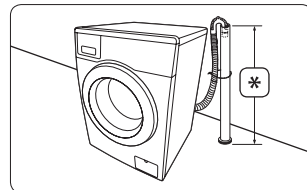

STEP 5 - Powering your washing machine

Plug the power cord into a wall socket, an AC 220 - 240V / 50Hz approved electrical outlet protected by a fuse or circuit breaker. (For more information on the electrical and grounding requirements, refer to the "Electrical supply and grounding" section on page 12.)



Test run

Make sure that you install your washing machine correctly by running the Rinse+Spin cycle after the installation is complete.

STEP 6 - Running Calibration Mode

Your Samsung washing machine detects the weight of the laundry automatically. For a more accurate weight detection, it is recommended running Calibration Mode immediately after installing the washing machine. Follow the steps below to run Calibration Mode.



Before running Calibration Mode, make sure that there is nothing in the drum or on top of the washing machine.

1. Turn the washing machine off.
2. Press the **Power** button while holding down the **Temp.** and **Delay End** buttons simultaneously. The washing machine will turn on and "CLB" will appear on the display.
3. Press the **Start/Pause** button to start Calibration Mode.
4. The drum will rotate clockwise and counter-clockwise for about 3 minutes.
5. When Calibration Mode is complete, "End" appears on the display and the washing machine will turn off automatically.
6. The washing machine is now ready for use.

■ Using your washing machine

With your new Samsung washing machine, the hardest part of doing laundry will be deciding which load to wash first.

Detergent and Additives Information

■ Using the proper detergent

The type of detergent you should use is based on the type of fabric (cotton, synthetic, delicate items, wool), colour, wash temperature, and degree of soiling. Always use "low suds" laundry detergent, which is designed for automatic washing machines.

Follow the detergent manufacturer's recommendations based on the weight of the laundry, the degree of soiling, and the hardness of the water in your area. If you do not know how hard your water is, enquire at your local water authority.

 Do not use detergent that has hardened or solidified as the detergent may remain in the rinse cycle. It may cause your washing machine to not rinse properly or result in the overflow becoming blocked.

■ Using the detergent drawer

Your washing machine has separate compartments for dispensing detergent and fabric softener.

Add all laundry additives to the correct compartments before starting your washing machine.

 **CAUTION:** Do not open the detergent drawer while the washing machine is running. You might be exposed to hot water or steam.

 When washing large items, do not use the following types of detergent.

- Tablet and capsule type detergent
- Detergent using a ball and net

①	Prewash detergent compartment: Detergent for prewash, or starch.
②	Main wash detergent compartment: Detergent for the main wash, water softener, pre-soaking agent, bleach and stain removal product.
⊗	Softener compartment: Additives, e.g. fabric softener (fill no higher than the lower edge (MAX) of "A").

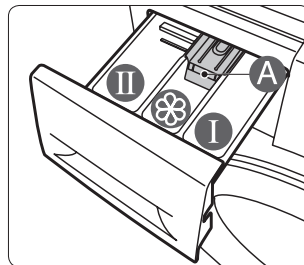

1. Pull out the detergent drawer at the top left of the washing machine.
2. Add the recommended amount of laundry detergent into the **main wash detergent compartment** ② before starting your washing machine.

 To use liquid detergent, use the liquid detergent guide (refer to the "**Using liquid detergent (selected models)**" section on page 20).

Do not add powder detergent into the liquid detergent guide.

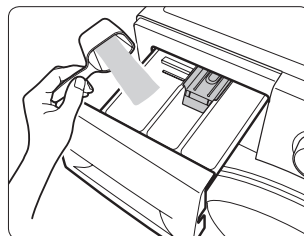

3. Add the recommended amount of fabric softener into the **softener compartment** (⊗) if required.

Do not exceed the **MAX** (A) line.

-  Concentrated or thick fabric softener and conditioner must be diluted with a little water before adding it to the compartment (prevents the overflow from becoming blocked).

 **CAUTION:** Do not add powder or liquid detergent to the **softener compartment** (⊗).

4. When using the Prewash function, add the recommended amount of laundry detergent into the **prewash detergent compartment** (①).

5. Push the detergent drawer in to close it.

-  Be careful that the fabric softener does not overflow when you close the detergent drawer after adding fabric softener into the softener compartment.

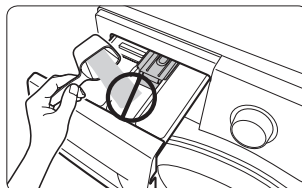
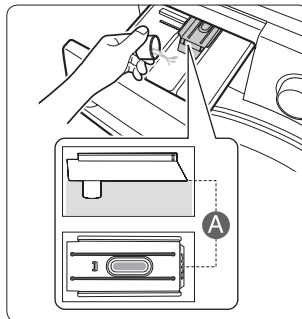

Using liquid detergent (selected models)

To use liquid detergent, place the liquid detergent guide into the **main wash detergent compartment** (②) of the detergent drawer and pour liquid detergent into the main wash compartment. Do not exceed the MAX line on the liquid detergent guide.

-  • Insert the liquid detergent guide only after you remove the detergent drawer from the washing machine by pressing **release lever(A)**.
- After a wash, some liquid detergent may remain in the detergent drawer.

-  **CAUTION:**
- Do not use the Prewash function when you use liquid detergent.
 - Remove the liquid detergent guide when you use powder detergent.

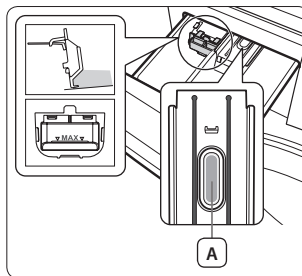







Doing laundry for the first time

 Before doing laundry for the first time, you must run a complete empty cycle (i.e. without laundry).

1. Press the **Power** button.
2. Add a little detergent to the **main wash compartment**  in the detergent drawer.
3. Turn on the water supply to the washing machine.
4. Turn the Cycle Selector to select Rinse+Spin cycle.
5. Press the **Start/Pause** button.

 This will remove any water that might be left over in the drum from the manufacturer's test run.

Basic instructions

1. Add your laundry loosely into the drum without overfilling it.
 -  **CAUTION:** Do not overload the washing machine. To determine the load capacity for each type of laundry, refer to the "**Determining the load capacity**" section on page 29.
 -  Do not wash water-proof items in a normal cycle except with the Outdoor Care cycle.
2. Close the door until it latches.
 -  **CAUTION:** Detergent may remain in the front rubber seal of the washing machine or the door seal after a wash cycle. Remove any remaining detergent before you close the door, as it may cause a water leak.
 -  **CAUTION:** Make sure that laundry is not caught in the door, as this may cause a water leak.
3. Turn the power on.
 -  **Last Memory function**
 - When you turn your washing machine on, the last used setting is reflected on the control panel. However, if the last used setting was Eco Drum Clean, Rinse+Spin or the Spin cycle, this function is not applied.
 - If you turn the Cycle Selector even slightly after turning the washing machine on, this function does not applied and the control panel is reset.
4. Add detergent, and if necessary, softener or prewash detergent into the appropriate compartments in the detergent drawer.
5. Select the appropriate cycle and options for the load. The relevant indicators will light up and the estimated cycle time will appear on the display.
6. Press the **Start/Pause** button.
 -  **CAUTION:** Do not touch the door glass while your washing machine is running as it may be hot.
 -  **CAUTION:** Do not open the detergent drawer or the debris filter while your washing machine is operating as you might be exposed to hot water or steam.

Using the control panel

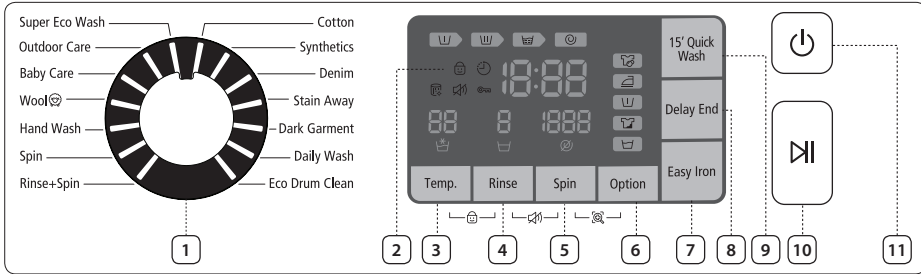

1. Cycle Selector

Select the tumble pattern and spin speed for the cycle.

For more information on each cycle, refer to the "Using the Cycle Selector" section on page 24.

2. Digital graphic display

Displays the remaining wash cycle time, all cycle information, and error messages.

3. Temp. button

Press this button repeatedly to cycle through the available water temperature options:







(Cold water , 20 °C, 30 °C, 40 °C, 60 °C and 95 °C).



4. Rinse button

Press this button to add additional rinse cycles. The maximum number of rinse cycles is five.

5. Spin button

Press the button repeatedly to cycle through the available speeds for the spin cycle.



WF80F5E**4*, WF80F5E**H*, WF70F5E**4*, WF70F5E**H*	  400, 800, 1200, 1400 rpm
WF80F5E**2*, WF80F5E**M*, WF70F5E**2*, WF70F5E**M*, WF60F4E**2*, WF60F4E**M*	  400, 800, 1000, 1200 rpm
WF60F4E**0*, WF60F4E**L*	  400, 600, 800, 1000 rpm

	Rinse Hold: The laundry remains soaking in the final rinse water. Either a drain or spin cycle must be performed to unload the laundry.
	No spin: The laundry remains in the drum and no spin cycle is performed after the final drain.

6. Option button

Press this button repeatedly to cycle through the options:

Soak > Intensive > Prewash > Soak + Intensive > Soak + Prewash > Intensive + Prewash > Soak + Intensive + Prewash > off

	<p>Soak: Use this function to effectively remove stains from your laundry by soaking your laundry.</p> <ul style="list-style-type: none"> The Soak function is performed 13 minutes into the wash cycle. The Soak function continues for 30 minutes with six cycles, where one cycle is a Soak cycle that spins for 1 minute and stands still for 4 minutes. The Soak function is only available with the: Cotton, Synthetics, Denim, Stain Away, Daily Wash, Super Eco Wash and Baby Care cycles.
	<p>Intensive: Use this function when the laundry is heavily soiled and needs to be washed intensively. The cycle time is increased for each cycle.</p>
	<p>Prewash: Use this function to prewash your laundry before the main wash cycle. The Prewash function is only available with the Cotton, Synthetics, Denim, Stain Away, Dark Garment, Daily Wash, Super Eco Wash and Baby Care cycles.</p>

7. Easy Iron button

Press this button to prepare your laundry so that it can be easily ironed by reducing the wrinkles during the Spin cycle.

Easy Iron is only available with the: Cotton, Synthetics, Denim, Stain Away, Dark Garment, Daily Wash, Super Eco Wash and Baby Care cycles.

When the Easy Iron function is selected, you can set the spin cycle speed up to 800 rpm. (If you select the Easy Iron function with a spin cycle speed set to higher than 800 rpm, the spin cycle speed is automatically changed to 800 rpm.)

8. Delay End button

Press this button repeatedly to cycle through the available Delay End options (from 3 hours to 19 hours in one hour increments).

The hour displayed indicates the time when the wash will finish.

9. 15' Quick Wash button

For lightly soiled garments and less than 2 kg laundry that you require quickly. It takes a minimum of about 15 minutes, but can vary from the indicated values depending on the water pressure, water hardness, water inlet temperature, room temperature, type and amount of washing and degree of soiling, utilized detergent unbalanced load, fluctuation in the electricity supply and any extra options selected.

This cycle is only available for the Cotton cycle.

 **CAUTION:** There should be less than 20 g of detergent (for 2 kg load) or detergent may remain on the clothes.

Press this button repeatedly to choose the cycle time:

15 min. > 20 min. > 30 min. > 40 min. > 50 min. > 1 hr. > Off

10. Start/Pause button

Press this button to pause and restart a cycle.

11. Power button

Press this button once to turn the washing machine on. Then press this button again to turn it off.

If the washing machine is left on for more than 10 minutes without any buttons being operated, the power automatically turns off.

Using the Cycle Selector

Cycle	Usage
Cotton	<p>For averagely or lightly soiled cottons, bed linen, table linen, underwear, towels, shirts, etc.</p> <p>For bedding or bedding covers, the recommended spin cycle speed is 800 rpm (for a load of 2.0 kg or less).</p> <p> 6kg-class models do not have a function for washing bedding.</p>
Synthetics	For averagely or lightly soiled blouses, shirts, etc., made of polyester (diolen, trevira), polyamide (perlon, nylon) or other similar blends.
Denim	A wash cycle with a higher water level and an extra rinse cycle that ensures that no powdered detergent remains to mark your clothing.
Stain Away	<p>For stained clothing. The Stain Away cycle provides outstanding stain removal performance of the utmost care, avoiding the need for the pre-treatment of stains. For the best stain removal performance, we recommend using the hot temperature option in this cycle, where the wash temperature is increased using the internal heater for the overall cleaning of a wide variety of stains.</p> <p>This cycle includes a soaking action that removes stains from your laundry effectively. During the soaking action, the drum stops rotating for a while, and this is not a malfunction.</p>
Dark Garment	Additional rinse cycles and a reduced spin cycle speed ensure that your favourite dark clothing is washed gently and rinsed thoroughly.
Daily Wash	For everyday items such as underwear and shirts.
Eco Drum Clean	For cleaning the drum. It cleanses dirt and bacteria from the drum. Regular use (after every 40 washes) is recommended. No detergent or bleach is required.
Super Eco Wash	The low temperature Super Eco Wash cycle ensures that you achieve perfect wash results while allowing for effective energy savings.
Outdoor Care	For water-proof items such as mountain clothing, skiwear, and sportswear. Fabrics include functional technology finishes and fibres such as spandex, stretch, and micro-fibre.
Baby Care	A high temperature wash and extra rinse cycles ensure that no powdered detergent remains to harm your baby's skin.
Wool	<p>Only for machine-washable wool. A load should be less than 2.0 kg. (6 kg - class model : 1.5 kg)</p> <p>The Wool cycle washes the laundry using a gentle cradling action. During the wash cycle, the gentle cradling and soaking actions are continued to protect the wool fibres from shrinkage/distortion and for a super gentle clean. This stop/start operation by the washing machine during the soaking action is not a malfunction.</p> <p>A neutral detergent is recommended for the Wool cycle, for improved washing results and for improved care of the wool fibres.</p>
Hand Wash	A very light wash cycle as gentle as a hand wash.
Spin	Performs an additional spin cycle to remove more water.
Rinse+Spin	For a load that only needs rinsing or to add a rinse-added fabric softener to a load.

Child Lock

The Child Lock function allows you to lock the buttons so that the wash cycle you've chosen can't be changed.

Activating/Deactivating

If you want to activate or deactivate the Child Lock function, hold down the **Temp.** and **Rinse** buttons at the same time for 3 seconds. The "Child Lock" indicator will light up when this feature is activated.



When the Child Lock function is activated, only the **Power** button works. The Child Lock function remains on even after the power is turned on and off or after disconnecting and reconnecting the power cord.

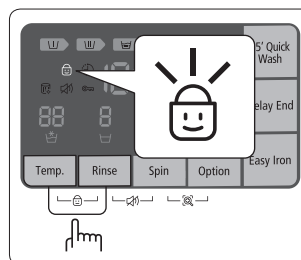

Sound Off

The Sound Off function can be selected during all cycles. When this function is selected, sound is turned off for all cycles. Even if the power is turned on and off repeatedly, the setting is retained.

Activating/Deactivating

If you want to activate or deactivate the Sound Off function, hold down the **Rinse** and **Spin** buttons at the same time for 3 seconds. The "Sound Off" indicator will light up when this feature is activated.

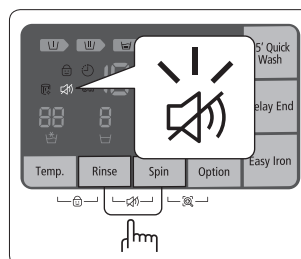

Delay End

You can set the washing machine to finish your wash automatically at a later time, choosing a delay of between 3 to 19 hours (in 1 hour increments). The hour displayed indicates the time when the wash will finish.

1. Add your laundry loosely into the drum without overfilling it.
2. Press the **Power** button to turn the power on.
3. Select the appropriate cycle and options for the load.
4. Press the **Delay End** button repeatedly until the delay time is set.
5. Press the **Start/Pause** button.

The "Delay End" indicator will light up, and the clock will begin counting down until it reaches the set time.

6. To cancel the Delay End function, turn the washing machine off and then turn it on again by pressing the **Power** button.

Smart Check

This function enables you to check the status of the washing machine using a smartphone.



The Smart Check function has been optimized for:

- Galaxy S and Galaxy S2
- iPhone 4 and iPhone 4S

Downloading the Samsung Smart Washer app

Download the Samsung Smart Washer app to your mobile phone from the Android market or Apple App store and install it. You can easily find it by searching for "**Samsung Smart Washer**".

Using the Smart Check function

1. Hold down the **Spin** and **Option** buttons at the same time for 3 seconds when an error occurs to run the Smart Check function. Alternatively, the Smart Check function can be run if no button is pressed after the washing machine is turned on.
2. The LED segments on the display panel rotate for 2 or 3 seconds and the Smart Check code is displayed on the washing machine's display panel.

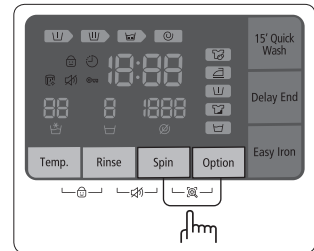

3. Run the **Samsung Smart Washer** app on your smart phone and tap the **Smart Check** button.



'Smart Check' may be changed to 'Smart Care' according to the language selection.

4. Focus your smart phone's camera on the Smart Check code displayed on the washing machine's display panel.





- If light from a light bulb, fluorescent bulb or lamp is reflected on the display panel of the washing machine, the smart phone may not be able to easily recognize the Smart Check code.
- If you hold the smart phone at a too wide angle relative to the front of the display panel, it may not be able to recognize the error code. For best results, hold the smart phone so that the front of the display panel and the smart phone are parallel or nearly parallel.

5. If it focuses correctly, the Smart Check code is automatically recognized, and the detailed information of the status of your washing machine, the error and the countermeasures are displayed on your smart phone.
6. If the smart phone fails to recognize the Smart Check code more than twice, please enter the Smart Check code displayed on your washing machine's display panel into the Samsung Smart Washer app manually.

Doing laundry

Doing laundry using the Cycle Selector

Your new washing machine makes washing laundry easy, using Samsung's automatic control system "Fuzzy Control". When you select a wash cycle, the machine will set the correct temperature, washing time, and washing speed.

1. Turn the water supply on.
2. Press the **Power** button to turn the power on.
3. Open the door.
4. Add your laundry loosely into the drum without overfilling it.
5. Close the door.
6. Add detergent, and if necessary, softener or prewash detergent into the appropriate compartments in the detergent drawer.
 -  The Prewash function is only available when selecting the Cotton, Synthetics, Denim, Stain Away, Dark Garment, Daily Wash, Super Eco Wash and Baby Care cycles. It is only necessary if your clothing is heavily soiled.
7. Use the Cycle Selector to select the appropriate cycle according to the type of material: Cotton, Synthetics, Denim, Stain Away, Dark Garment, Daily Wash, Super Eco Wash, Outdoor Care, Baby Care, Wool and Hand Wash. The relevant indicators will light up on the control panel.
8. At this time, you can control the wash temperature, the number of rinse cycles, the spinning speed, and the delay time by pressing the appropriate buttons.
9. Press the **Start/Pause** button to start the wash. The progress indicator will light up and the remaining time for the cycle will appear on the display.
 -  Both the total cycle time and the number of rinse cycles in the Cotton cycle may vary depending on the amount of laundry.
10. After the total cycle has finished, the power will turn off automatically. Open the door and remove the laundry.



Pausing the wash

Within 5 minutes of starting a wash, it is possible to add/remove laundry items.

1. Press the **Start/Pause** button to unlock the door.
 -  If the water level or the water temperature inside the drum is too HIGH the door is not opened with the blinking "Door Lock" indicator. In this case, wait until the indicator stops blinking. (It will take approximately 1 or 2 minutes until the indicator stops blinking.)
2. Open the door and add/remove the laundry.
3. After closing the door, press the **Start/Pause** button to restart the wash.

Doing laundry manually

You can do laundry manually without using the Cycle Selector.

1. Turn the water supply on.
2. Press the **Power** button to turn the power on.
3. Open the door.
4. Add your laundry loosely into the drum without overfilling it.
5. Close the door.
6. Add detergent, and if necessary, softener or prewash detergent into the appropriate compartments in the detergent drawer.
7. Turn the Cycle Selector to select Cotton cycle.
8. Press the **Temp.** button to select the temperature.
(Cold water , 20 °C, 30 °C, 40 °C, 60 °C and 95 °C)
9. Press the **Rinse** button to select the number of rinse cycles.
The maximum number of rinse cycles is five.
The wash duration is increased accordingly.
10. Press the **Spin** button to select the spin speed. (: Rinse Hold, : No spin)
11. Press the **Delay End** button repeatedly to cycle through the available Delay End options (from 3 hour to 19 hours in one hour increments). The hour displayed indicates the time when the wash will finish.
12. Press the **Start/Pause** button to start the wash.

Laundry guidelines

Follow these simple guidelines for the cleanest laundry and the most efficient wash.



Always check the care label on clothing before washing.

Sort and wash your laundry according to the following criteria:

- Care Label: Sort laundry into cottons, mixed fibres, synthetics, silks, wools and rayons.
- Colour: Divide whites and colours. Wash colour items separately.
- Size: Placing items of different sizes in the same load will improve the wash action.
- Sensitivity: Wash delicate items separately using a delicate wash cycle for pure, new woollen items, curtains and silk articles. Check the labels on the items you are washing or refer to the "**Fabric care chart**" section on page 38.

Emptying pockets

Before each wash, empty all the pockets of your laundry items. Small, irregularly shaped hard objects, such as coins, knives, pins, and paperclips can damage your washing machine.

Do not wash clothing with large buckles, buttons, or other heavy metal objects. Metal on clothing may damage your clothing as well as the drum. Turn clothing with buttons and embroidered clothes inside out before washing them. If zips of pants and jackets are open while washing, the drum may be damaged. Zips should be closed and fixed with a string before washing.

Clothing with long strings may become entangled with other clothes damaging them. Be sure to fix the strings before starting the wash.



Prewashing cotton

Your new washing machine, combined with modern detergents, will give perfect washing results, saving you energy, time, water and detergent. However, if your cotton is particularly dirty, perform a prewash cycle with a protein-based detergent.

■ Determining the load capacity

Do not overload the washing machine or your laundry may not wash properly. Use the chart below to determine the load capacity for the type of laundry you are washing.

Fabric Type	Load Capacity (kg)		
	WF80F5E	WF70F5E	WF60F4E
Cotton	8.0	7.0	6.0
Synthetics	3.5	3.5	3.0
Denim	3.0	3.0	3.0
Outdoor Care	2.0	2.0	2.0
Wool	2.0	2.0	1.5

-  When the laundry is unbalanced and the "UE" error code is displayed, redistribute the load. If the laundry is unbalanced, the spin efficiency may be degraded.
-  When washing bedding or bedding covers, the wash time may be lengthened or the spin efficiency may be degraded.
For bedding or bedding covers, the recommended maximum spin cycle speed is 800 rpm and the load capacity is 2.0 kg or less.
-  6 kg-class models do not have a function for washing bedding.

 **CAUTION:** Make sure to insert brassieres (water washable) into a laundry net (to be purchased additionally).

- The metal parts of the brassieres may break through the material and damage the laundry. Therefore make sure to place them inside a fine laundry net.
- Small, light clothing such as socks, gloves, stockings and handkerchiefs may become caught around the door. Place them inside a fine laundry net.

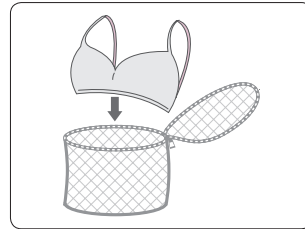

 **CAUTION:** Do not wash the laundry net by itself without other laundry. This may cause abnormal vibrations that could move the washing machine and result in injury.

■ Cleaning your washing machine

Keeping your washing machine clean improves its performance, wards off unnecessary repairs, and lengthens its life.

⚠ CAUTION: Never use the Eco Drum Clean cycle when laundry is in the washing machine. This may result in damage to the laundry or a problem with the washing machine.

Eco Drum Clean

This cycle is a self-cleaning cycle that removes mold that may occur inside the drum.

■ Cleaning procedures

1. Press the **Power** button to turn the power on.
2. Turn the Cycle Selector to select Eco Drum Clean cycle.
 - You can only use the Delay End function with the Eco Drum Clean cycle.
 - During the Eco Drum Clean cycle, the water temperature is set to 70 °C. You cannot change the water temperature.

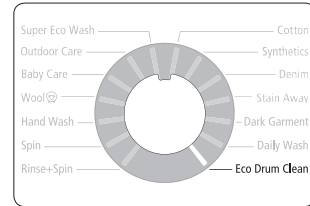

3. Press the **Start/Pause** button to start the Eco Drum Clean cycle.

⚠ Do not use any cleaning agents for cleaning the drum. Chemical residue in the drum deteriorates the washing performance.

■ Eco Drum Clean auto alarm function

After a wash, if it is detected that cleaning the drum is required, the Eco Drum Clean indicator on the display and the corresponding lamp on the Cycle Selector are lit. In this case, remove the laundry from the washing machine, turn the power on, and clean the drum by performing the Eco Drum Clean cycle.

If you do not perform the Eco Drum Clean cycle, the Eco Drum Clean indicator on the display and the corresponding lamp on the Cycle Selector are turned off. They will be turned on again after two washes are performed. Note that this does not indicate that there is a problem with the washing machine.

Although the Eco Drum Clean auto alarm function usually operates once a month, the frequency may differ depending on how often the washing machine is used.

⚠ If the alarm occurs, clean the debris filter as well (refer to the "**Cleaning the debris filter**" section on page 32). Failure to do so may decrease the performance of the Eco Bubble function.

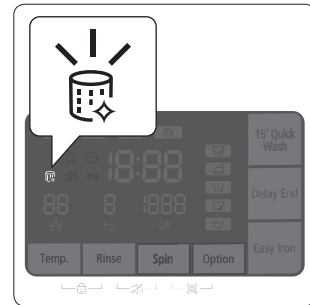

Draining the washing machine in an emergency

 If there is a power outage, drain all remaining water before removing your laundry.

1. Unplug the washing machine from the electrical outlet.
2. Open the **filter cover (A)** by using a coin or key.

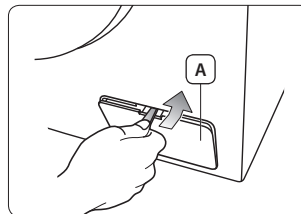

3. Prepare a bowl.

 The remaining water may be more than you expected. Use a large bowl.

4. Pick the **emergency draining tube (C)** out and open the **emergency drain cap (B)** by pulling it.

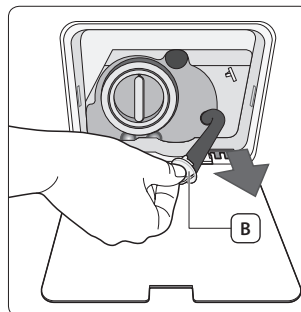

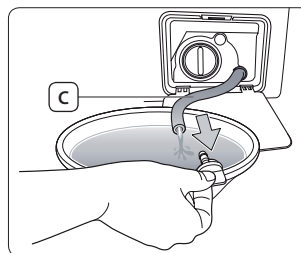

5. Hold the cap at the end of the **emergency draining tube (C)** and slowly pull it out.
6. Allow all the water to flow into a bowl.
7. Reinsert the emergency drain cap and the drain tube.
8. Close the filter cover.



Cleaning the debris filter

We recommend cleaning the debris filter 5 or 6 times a year, or when the "SE" error message is displayed. If foreign substances accumulate at the debris filter, the performance of the Eco Bubble function will be degraded.

 **CAUTION:** Before cleaning the debris filter, make sure to unplug the washing machine from the electrical outlet.

 **CAUTION:** Do not disassemble the debris filter while the machine is running as hot water may flow out.

1. Open the filter cover by using a coin or key.
2. Remove the remaining water (refer to the "**Draining the washing machine in an emergency**" section on page 31.)

 If you separate the filter without draining the remaining water, the remaining water may trickle out.

3. Unscrew the **debris filter cap (A)** by turning it to the left.

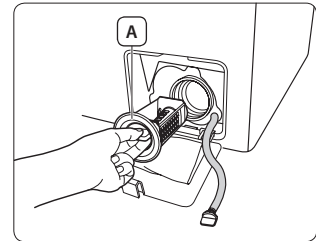

4. Wash any dirt or other material from the debris filter. Make sure the drain pump propeller behind the debris filter is not blocked.
5. Replace the debris filter cap.
6. Close the filter cover.

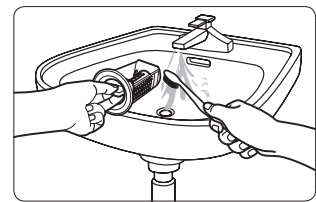

 Make sure to replace the debris filter after cleaning it. If the debris filter is not reinserted into the machine, your washing machine may malfunction or water may leak.

 Tighten the debris filter firmly after cleaning it. Failing to do so may result in a malfunction or water leak.

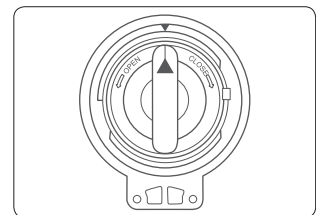

Cleaning the exterior

1. Wipe the washing machine surfaces, including the control panel, with a soft cloth using a nonabrasive household detergent.
2. Use a soft cloth to dry the surfaces.

 **CAUTION:** Do not pour water onto the washing machine.

Cleaning the detergent drawer and drawer recess

1. Press the **release lever (A)** on the inside of the detergent drawer and pull the detergent drawer out.
2. Remove the **release lever (A)** and the liquid detergent guide (optional) from the detergent drawer.

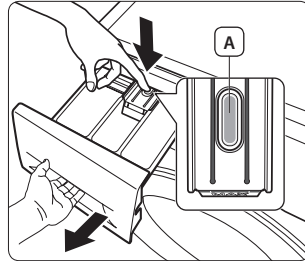

3. Wash all parts under running water.

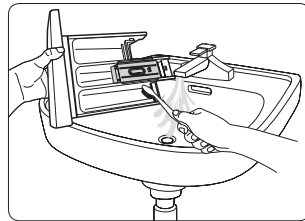

4. Clean the detergent drawer recess with an old toothbrush.
5. Replace the softener compartment and the liquid detergent guide (optional) by pushing them firmly into the detergent drawer.
6. Push the detergent drawer back into place.
7. To remove any remaining detergent, perform a rinse cycle without any laundry in the drum.

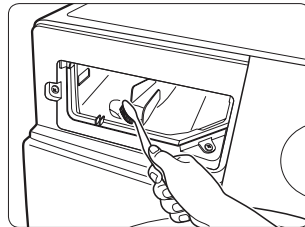

Cleaning the mesh filter

You should clean the mesh filter at least once a year, or when the "4E" error message is displayed.

1. Turn off the water supply to the washing machine.
2. Disconnect the L-shaped arm fitting for the water supply hose from the water supply intake at the back of the machine by turning **(A)**. To prevent water from running out due to the air pressure in the water supply hose, cover the hose connection with a cloth.
3. Gently pull out the mesh filters from the water supply intakes using a pair of pliers and rinse them under running water until they are clean.
4. Reinsert the mesh filters.
5. Reinstall the L-shaped arm fitting in the washing machine.
6. Make sure the connections are watertight and turn on the tap.

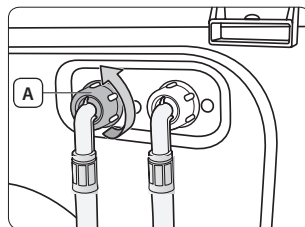

■ Maintaining your washing machine

Repairing a frozen washing machine

If the temperature drops below freezing and your washing machine is frozen:

1. Unplug the washing machine from the electrical outlet.
2. Pour warm water over the water tap to loosen the water supply hose.
3. Remove the water supply hose and soak it in warm water.
4. Pour warm water into the washing machine drum and let it sit for 10 minutes.
5. Reconnect the water supply hose to the water tap and check if the water supply and drain are operating normally.

Storing your washing machine

If you need to store your washing machine for an extended time, it's better to drain and disconnect it. The washing machine can be damaged if water is left in the hoses and internal components before storage. Prepare your washing machine for storage as follows:

1. Select the Cotton cycle, press the **15' Quick Wash** button and run your washing machine without laundry for this cycle.
2. Unplug the washing machine from the electrical outlet.
3. Turn the water taps off and disconnect the water supply hoses.
4. Leave your washing machine door open to allow air to circulate inside the drum.



If your washing machine has been stored in below-freezing temperatures, allow time for any leftover water in your washing machine to thaw out before using it.

■ Troubleshooting and information codes

Check these points if your washing machine...

PROBLEM	SOLUTION
Will not start	<ul style="list-style-type: none">• Make sure your washing machine is plugged in.• Make sure the door is firmly closed.• Make sure the water supply tap(s) are turned on.• Make sure to press the Start/Pause button.
Has no water or not enough water	<ul style="list-style-type: none">• Turn the water supply on.• Make sure the water supply hose is not frozen.• Straighten the water supply hoses.• Clean the mesh filters of water supply intakes.
Has detergent remaining in the detergent drawer after the wash cycle is complete	<ul style="list-style-type: none">• Make sure your washing machine is running with sufficient water pressure.• Make sure the detergent is added to the center of the detergent drawer.
Vibrates or is too noisy	<ul style="list-style-type: none">• Make sure your washing machine is on a level surface. If the surface is not level, adjust the washing machine feet to level the appliance.• Make sure that the shipping bolts are removed.• Make sure your washing machine is not touching any other object.• Make sure the laundry load is balanced.
The washing machine does not drain and/or spin	<ul style="list-style-type: none">• Straighten the drain hose. Eliminate kinked hoses.• Make sure the debris filter is not clogged.
Door is locked shut or will not open.	<ul style="list-style-type: none">• The door will not open until 3 minutes after the machine stops or the power turns off.

Information codes

If your washing machine malfunctions, you may see an information code on the display. If this happens, please check the table below and try the suggested solution before calling Customer Service.

CODE SYMBOL	SOLUTION
dE	<ul style="list-style-type: none">• Make sure the door is firmly closed.• Make sure that no laundry is caught in the door.
4E	<ul style="list-style-type: none">• Make sure the water supply tap(s) are turned on.• Check the water pressure.• Clean the mesh filters of water supply intakes.• Make sure the water supply hose is not kinked or clogged.
5E	<ul style="list-style-type: none">• Clean the debris filter.• Make sure the drain hose is installed correctly.
UE	<ul style="list-style-type: none">• The laundry load is unbalanced. Redistribute the load. If only one item of clothing needs washing, such as a bathrobe or pair of jeans, the final spin result might be unsatisfactory and a "UE" error message will be shown in the display window.
cE/3E/Uc	<ul style="list-style-type: none">• Call customer service.

For any codes not listed above, or if the suggested solution doesn't fix the problem, call your Samsung Service Centre or local Samsung dealer.

Cycle chart

Cycle chart

(● user option)

CYCLE	Max load (kg)			DETERGENT			Max Temp (°C)	Spin Speed (MAX) rpm		
	WF80F5	WF70F5	WF60F4	Prewash	Wash	Softener		1400	1200	1000
Cotton	8.0	7.0	6.0	Yes	●	●	95	1400	1200	1000
Synthetics	3.5	3.5	3.0	Yes	●	●	60	1200	1200	1000
Denim	3.0	3.0	3.0	Yes	●	●	60	800	800	800
Stain Away	4.0	4.0	3.0	Yes	●	●	60	1200	1200	1000
Dark Garment	4.0	4.0	3.0	Yes	●	●	40	1200	1200	1000
Daily Wash	4.0	4.0	3.0	Yes	●	●	60	1400	1200	1000
Eco Drum Clean	-	-	-	-	-	-	70	400	400	400
Super Eco Wash	4.0	4.0	3.0	Yes	●	●	40	1200	1200	1000
Outdoor Care	2.0	2.0	2.0	-	●	●	40	1200	1200	1000
Baby Care	4.0	4.0	3.0	Yes	●	●	95	1400	1200	1000
Wool	2.0	2.0	1.5	-	●	●	40	800	800	800
Hand Wash	2.0	2.0	1.5	-	●	●	40	400	400	400

























CYCLE	Delay End	Intensive	Soak	Easy Iron	15' Quick Wash
Cotton	●	●	●	●	●
Synthetics	●	●	●	●	-
Denim	●	●	●	●	-
Stain Away	●	●	●	●	-
Dark Garment	●	●	-	●	-
Daily Wash	●	●	●	●	-
Eco Drum Clean	●	-	-	-	-
Super Eco Wash	●	●	●	●	-
Outdoor Care	●	-	-	-	-
Baby Care	●	●	●	●	-
Wool	●	-	-	-	-
Hand Wash	●	-	-	-	-

1. A cycle with a prewash takes approx. 20 minutes longer.
2. The cycle duration data has been measured under the conditions specified in Standard IEC60456/EN60456.
Please run Calibration Mode after the installation (refer to the "STEP 6 - Running Calibration Mode" section on page 18).
3. Daily Wash : A short cycle for test institutes.
4. Since this washing machine comes with the Last Memory function, to remove the Last Memory setting and use the original startup settings, you need to clear the last used setting on the control panel. (For information on how to clear the last used setting, refer to the descriptions about the "Last Memory function" on page 21.)
5. Cycle time in individual homes may differ from the values given in the table due to variations in the pressure and temperature of the water supply, the load and the type of laundry.
6. When the Intensive Wash function is selected, the cycle time is increased for each cycle.

■ Appendix

Fabric care chart

The following symbols provide garment care directions. The care labels include four symbols in this order: washing, bleaching, drying and ironing (and dry cleaning when necessary). The use of symbols ensures consistency among garment manufacturers of domestic and imported items. Follow the care label directions to maximize garment life and reduce laundry problems.

	Resistant material		Can be ironed at 100 °C max
	Delicate fabric		Do not iron
	Item can be washed at 95 °C		Can be dry cleaned using any solvent
	Item can be washed at 60 °C		Dry clean with perchloride, lighter fuel, pure alcohol or R113 only
	Item can be washed at 40 °C		Dry clean with aviation fuel, pure alcohol or R113 only
	Item can be washed at 30 °C		Do not dry clean
	Hand wash only		Dry flat
	Dry clean only		Can be hung to dry
	Can be bleached in cold water		Dry on clothes hanger
	Do not bleach		Tumble dry, normal heat
	Can be ironed at 200 °C max		Tumble dry, reduced heat
	Can be ironed at 150 °C max		Do not tumble dry

Protecting the environment

- This appliance is manufactured from recyclable materials. If you decide to dispose of this appliance, please observe local waste disposal regulations. Cut off the power cord so that the appliance cannot be connected to a power source. Remove the door so that animals and small children cannot get trapped inside the appliance.
- Do not exceed the detergent quantities recommended in the detergent manufacturers' instructions.
- Use stain removal products and bleaches before the wash cycle only when strictly necessary.
- Save water and electricity by only washing full loads (the exact amount depends upon the selected cycle).

Declaration of conformity

This appliance complies with European safety standards, EC directive 93/68 and EN Standard 60335.

Sheet of household washing machines



The design and specifications are subject to change without notice for quality improvement purposes.

According to Regulation (EU) No. 1061/2010

Samsung					
Model Name		WF80F5E*U4*	WF80F5E*U2*	WF70F5E*U4*	WF70F5E*U2*
		WF80F5E*UH*	WF80F5E*UM*	WF70F5E*UH*	WF70F5E*UM*
		WF80F5E*P4*	WF80F5E*P2*	WF70F5E*P4*	WF70F5E*P2*
		WF80F5E*PH*	WF80F5E*PM*	WF70F5E*PH*	WF70F5E*PM*
Capacity	kg	8		7	
Energy Efficiency					
A + + + (highest efficiency) to D (least efficient)		A+++		A+++	
Energy Consumption					
Annual Energy Consumption (AE_C) ¹⁾	kWh/yr	157		122	
Energy consumption (E_t.60) Cotton 60 °C at full load	kWh	0.88		0.68	
Energy consumption (E_t.60.1/2) Cotton 60 °C with partial load	kWh	0.68		0.52	
Energy consumption (E_t.40.1/2) Cotton 40 °C with partial load	kWh	0.41		0.34	
Weighted power off-mode (P_o)	W	0.48		0.48	
Weighted Power in left-on mode (P_l)	W	5		5	
Annual water consumption (AW_c) ²⁾	L/yr	10500		9400	
Spin efficiency class ³⁾					
A (most efficient) to G (least efficient)		B		B	
Maximum Spin Speed	rpm	1400	1200	1400	1200
Residual moisture	%	53	56	53	56
Programs to which the information on the label and the Sheet relate		Cotton 60 °C and 40 °C + Intensive ⁴⁾			
Program duration of the standard program					
Cotton 60 °C at full load	min	242		242	
Cotton 60 °C for partial load	min	194		214	
Cotton 40 °C with partial load	min	174		174	
Weighted time in left-on mode	min	2		2	
Airborne noise emissions					
Wash	dB (A) re 1 pW	53		54	
Spin	dB (A) re 1 pW	74		74	
Dimensions					
Unit dimensions	Height	mm	850		850
	Width	mm	600		600
	Depth ⁵⁾	mm	550		550
Net weight	kg	61		61	
Gross weight	kg	63		63	
Package weight	kg	2		2	
Water Pressure	kPa	50-800		50-800	
Electrical connection					
Voltage	V	220-240		220-240	
Power consumption	W	2000-2400		2000-2400	
Frequency	Hz	50		50	
Name and address of company		Samsung Electronics Co., Ltd. 129, Samsung-ro, Yeongtong-gu, Suwon-si, Gyeonggi-do, Korea			



The design and specifications are subject to change without notice for quality improvement purposes.

According to Regulation (EU) No. 1061/2010

Samsung					
Model Name		WF80F5E*W4* WF80F5E*WH* WF80F5E*Q4* WF80F5E*QH*	WF80F5E*W2* WF80F5E*WM* WF80F5E*Q2* WF80F5E*QM*	WF70F5E*W4* WF70F5E*WH* WF70F5E*Q4* WF70F5E*QH*	WF70F5E*W2* WF70F5E*WM* WF70F5E*Q2* WF70F5E*QM*
Capacity	kg	8		7	
Energy Efficiency					
A + + + (highest efficiency) to D (least efficient)		A+++		A+++	
Energy Consumption					
Annual Energy Consumption (AE_C) ¹⁾	kWh/yr	195		173	
Energy consumption (E_t.60) Cotton 60 °C at full load	kWh	1.06		0.94	
Energy consumption (E_t.60.1/2) Cotton 60 °C with partial load	kWh	0.86		0.80	
Energy consumption (E_t.40.1/2) Cotton 40 °C with partial load	kWh	0.58		0.59	
Weighted power off-mode (P_o)	W	0.48		0.48	
Weighted Power in left-on mode (P_l)	W	5		5	
Annual water consumption (AW_c) ²⁾	L/yr	10500		9400	
Spin efficiency class³⁾					
A (most efficient) to G (least efficient)		B		B	
Maximum Spin Speed	rpm	1400	1200	1400	1200
Residual moisture	%	53	56	53	56
Programs to which the information on the label and the Sheet relate		Cotton 60 °C and 40 °C + Intensive ⁴⁾			
Program duration of the standard program					
Cotton 60 °C at full load	min	239		239	
Cotton 60 °C for partial load	min	191		211	
Cotton 40 °C with partial load	min	171		171	
Weighted time in left-on mode	min	2		2	
Airborne noise emissions					
Wash	dB (A) re 1 pW	62	62	62	62
Spin	dB (A) re 1 pW	79	76	79	76
Dimensions					
Unit dimensions	Height	mm	850		850
	Width	mm	600		600
	Depth ⁵⁾	mm	550		550
Net weight	kg	64		64	
Gross weight	kg	66		66	
Package weight	kg	2		2	
Water Pressure	kPa	50-800		50-800	
Electrical connection					
Voltage	V	220-240		220-240	
Power consumption	W	2000-2400		2000-2400	
Frequency	Hz	50		50	
Name and address of company		Samsung Electronics Co., Ltd. 129, Samsung-ro, Yeongtong-gu, Suwon-si, Gyeonggi-do, Korea			



The design and specifications are subject to change without notice for quality improvement purposes.

According to Regulation (EU) No. 1061/2010

Samsung			
Model Name		WF60F4E**2* WF60F4E**M*	WF60F4E**0* WF60F4E**L*
Capacity	kg	6	
Energy Efficiency			
A+++ (highest efficiency) to D (least efficient)		A++	
Energy Consumption			
Annual Energy Consumption (AE_C) ¹⁾	kWh/yr	170	
Energy consumption (E_t60) Cotton 60 °C at full load	kWh	1.02	
Energy consumption (E_t60.1/2) Cotton 60 °C with partial load	kWh	0.65	
Energy consumption (E_t40.1/2) Cotton 40 °C with partial load	kWh	0.46	
Weighted power off-mode (P_o)	W	0.48	
Weighted Power in left-on mode (P_l)	W	5	
Annual water consumption (AW_c) ²⁾	L/yr	8580	
Spin efficiency class ³⁾			
A (most efficient) to G (least efficient)		B	C
Maximum Spin Speed	rpm	1200	1000
Residual moisture	%	56	65
Programs to which the information on the label and the Sheet relate		Cotton 60 °C and 40 °C + Intensive ⁴⁾	
Program duration of the standard program			
Cotton 60 °C at full load	min	249	
Cotton 60 °C for partial load	min	191	
Cotton 40 °C with partial load	min	171	
Weighted time in left-on mode	min	2	
Airborne noise emissions			
Wash	dB (A) re 1 pW	61	61
Spin	dB (A) re 1 pW	76	74
Dimensions			
Unit dimensions	Height	mm	850
	Width	mm	600
	Depth ⁵⁾	mm	400
Net weight	kg	56	
Gross weight	kg	58	
Package weight	kg	2	
Water Pressure	kPa	50-800	
Electrical connection			
Voltage	V	220-240	
Power consumption	W	2000-2400	
Frequency	Hz	50	
Name and address of company		Samsung Electronics Co., Ltd. 129, Samsung-ro, Yeongtong-gu, Suwon-si, Gyeonggi-do, Korea	

- Annual energy consumption is based on 220 standard washing cycles for Cotton programs at 60 °C and 40 °C at full and partial load, and the consumption of off and left-on modes. Actual energy consumption will depend on how the appliance is used.
- Annual water consumption is based on 220 standard washing cycles for Cotton programs at 60 °C and 40 °C at full and partial load. Actual water consumption will depend on how the appliance is used.
- Spin extraction is very important when you use a clothes dryer to dry your clothes.
The energy for drying costs much higher than the energy for washing.
Washing with the high spin saves more energy in drying your clothes in a clothes dryer.
- The 'standard Cotton 60 °C program' and 'standard Cotton 40 °C program', which can be selected by adding the Intensive option to the Cotton 60 °C and Cotton 40 °C program, are suitable to clean normally soiled cotton laundry and they are the most efficient (concerning water and energy consumption) for this type of laundry.
Please run Calibration Mode after the installation (refer to the "STEP 6 - Running Calibration Mode" section on page 18).
In these programs the actual water temperature may differ from the declared temperature.
- Distance to the wall from the unit is not included in the depth dimension.

Information of main washing programmes

Model	Course	Temp	Capacity	Program Time	Residual Moisture Content(%)			Water Consumption	Energy Consumption
		(°C)	(kg)	(min)	1400rpm	1200rpm	1000rpm	(ℓ/cycle)	(kWh/Cycle)
WF80F5E*Q4* / WF80F5E*QH* WF80F5E*W4* / WF80F5E*WH* WF80F5E*Q2* / WF80F5E*QM* WF80F5E*W2* / WF80F5E*WM*	Cotton	20	4	131	56	59	-	53	0.40
		40	4	171	53	56	-	43	0.58
	Cotton + intensive	60	4	191	53	56	-	43	0.86
			8	239	48	50	-	53	1.06
	Synthetics	40	3.5	130	35	35	-	53	0.66
	WF7*F5E*Q4* / WF7*F5E*QH* WF7*F5E*W4* / WF7*F5E*WH* WF7*F5E*Q2* / WF7*F5E*QM* WF7*F5E*W2* / WF7*F5E*WM*	Cotton	20	3.5	131	56	59	-	50
40			3.5	171	53	56	-	38	0.59
Cotton + intensive		60	3.5	211	53	56	-	38	0.80
			7	239	48	50	-	48	0.94
Synthetics		40	3.5	130	35	35	-	53	0.66
WF60F4E*N2* / WF60F4E*NM* WF60F4E*Z2* / WF60F4E*ZM* WF60F4E*N0* / WF60F4E*NL* WF60F4E*Z0* / WF60F4E*ZL*		Cotton	20	3.5	128	-	60	69	38
	40		3.5	191	-	56	65	38	0.59
	Cotton + intensive	60	3.5	211	-	56	65	38	0.78
			7	249	-	50	59	41	1.10
	Synthetics	40	3.5	128	-	35	45	36	0.45
	WF80F5E*U4* / WF80F5E*UH* WF80F5E*P4* / WF80F5E*PH* WF80F5E*U2* / WF80F5E*UM* WF80F5E*P2* / WF80F5E*PM*	Cotton	20	4	148	56	59	-	53
40			4	174	53	56	-	43	0.41
Cotton + intensive		60	4	194	53	56	-	43	0.68
			8	242	48	50	-	53	0.88
Synthetics		40	3.5	128	35	35	-	53	0.63
WF70F5E*U4* / WF70F5E*UH* WF70F5E*P4* / WF70F5E*PH* WF70F5E*U2* / WF70F5E*UM* WF70F5E*P2* / WF70F5E*PM*		Cotton	20	3.5	148	56	59	-	50
	40		3.5	174	53	56	-	38	0.34
	Cotton + intensive	60	3.5	214	53	56	-	38	0.52
			7	242	48	50	-	48	0.68
	Synthetics	40	3.5	128	35	35	-	53	0.63

The values on the table have been measured under the conditions specified in Standard IEC60456/EN60456. Actual values will depend on how the appliance is used.

■ Memo



QUESTIONS OR COMMENTS?

COUNTRY	CALL	OR VISIT US ONLINE AT
U.K	0330 SAMSUNG (7267864)	www.samsung.com
EIRE	0818 717100	www.samsung.com

DC68-03234K-02