

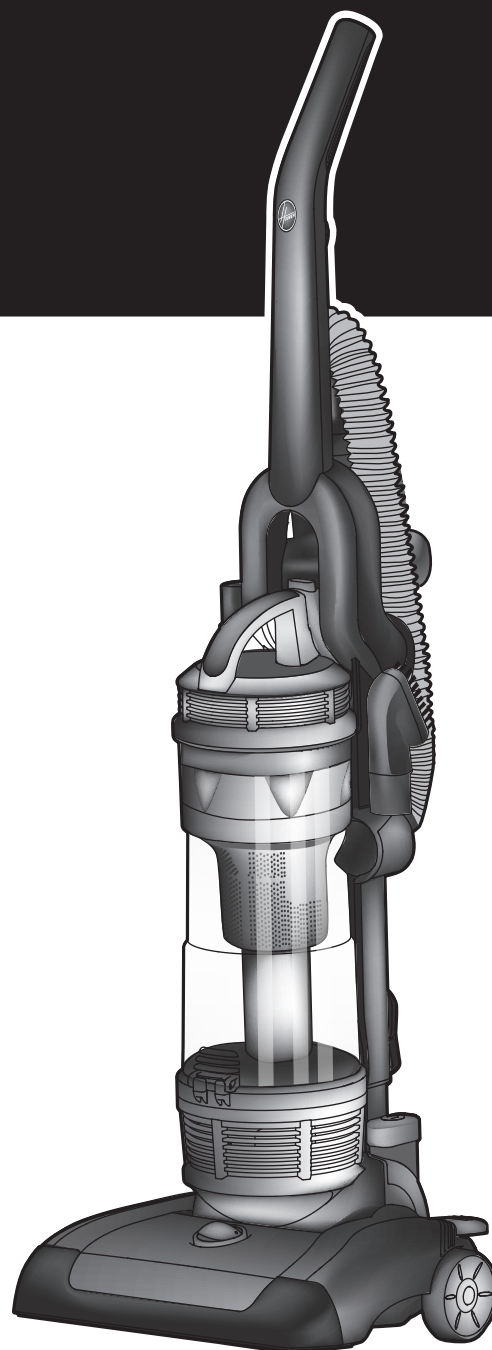

®

GENERATION FUTURE

HOOVER



USER MANUAL

IMPORTANT SAFETY REMINDERS

This appliance should only be used for domestic cleaning, as described in this user guide. Please ensure that this guide is fully understood before operating the appliance.

Do not leave the appliance plugged in. Always switch off and remove the plug from the socket after use, or before cleaning the appliance or any maintenance task.

This appliance can be used by children aged from 8 years and above and persons with reduced physical, sensory or mental capabilities or lack of experience and knowledge if they have been given supervision or instruction concerning use of the appliance in a safe way and understand the hazards involved. Children shall not play with the appliance. Cleaning and user maintenance shall not be made by children without supervision.

If the power cord is damaged stop using the appliance immediately. To avoid a safety hazard, an authorised Hoover service engineer must replace the power cord.

Keep hands, feet, loose clothing and hair away from rotating brushes.

Use only attachments, consumables or spares recommended or supplied by Hoover.

When using cleaning tools ensure that the appliance is kept in the upright (parked) position. This will avoid possible damage to the carpet or floor covering. When cleaning stairs, do not position the appliance above you.

Static electricity: some carpets can cause a small build up of static electricity. Any static discharge is not hazardous to health.

Do not use your appliance out of doors or on any wet surface or for wet pick up.

Do not pick up hard or sharp objects, matches, hot ashes,

cigarette ends or other similar items.

Do not spray with or pick up flammable liquids, cleaning fluids, aerosols or their vapours.

Do not run over the power cord when using your appliance or remove the plug by pulling on the power cord.

Do not continue to use your appliance if it appears faulty.

Hoover service: To ensure the continued safe and efficient operation of this appliance we recommend that any servicing or repairs are only carried out by an authorised Hoover service engineer.

Do not stand on or wrap the cord around arms or legs when using your appliance.

Do not use the appliance to clean animals or people.

When using the cleaning tools, ensure to always steady the appliance with your other hand. This will ensure that the appliance does not fall while in use.

WARNING: A thermal cut out switches off the appliance to prevent overheating if it is used when full or there is a blockage or dirty filters. If this should happen then switch off, unplug and correct the fault. It will take approximately 45 minutes for the cut out to automatically reset.

The Environment

The symbol on this appliance indicates that this appliance may not be treated as household waste. Instead it must be handed over to the applicable collection point for the recycling of electrical and electronic equipment. Disposal must be carried out in accordance with local environmental regulations for waste disposal. For more detailed information about treatment, recovery and recycling of this appliance, please contact your local city office, your household and waste disposal service or the shop where you purchased the appliance.

 This appliance complies with the European Directives 2006/95/EC, 2004/108/EC and 2011/65/EU.

HOOVER Limited, Pentrebach, Merthyr Tydfil, Mid Glamorgan, CF48 4TU, UK

GETTING TO KNOW YOUR CLEANER

Effortless cleaning with your new Hoover

This vacuum cleaner is supplied with an Energy Label as required by European Regulation (EU) 665/2013.

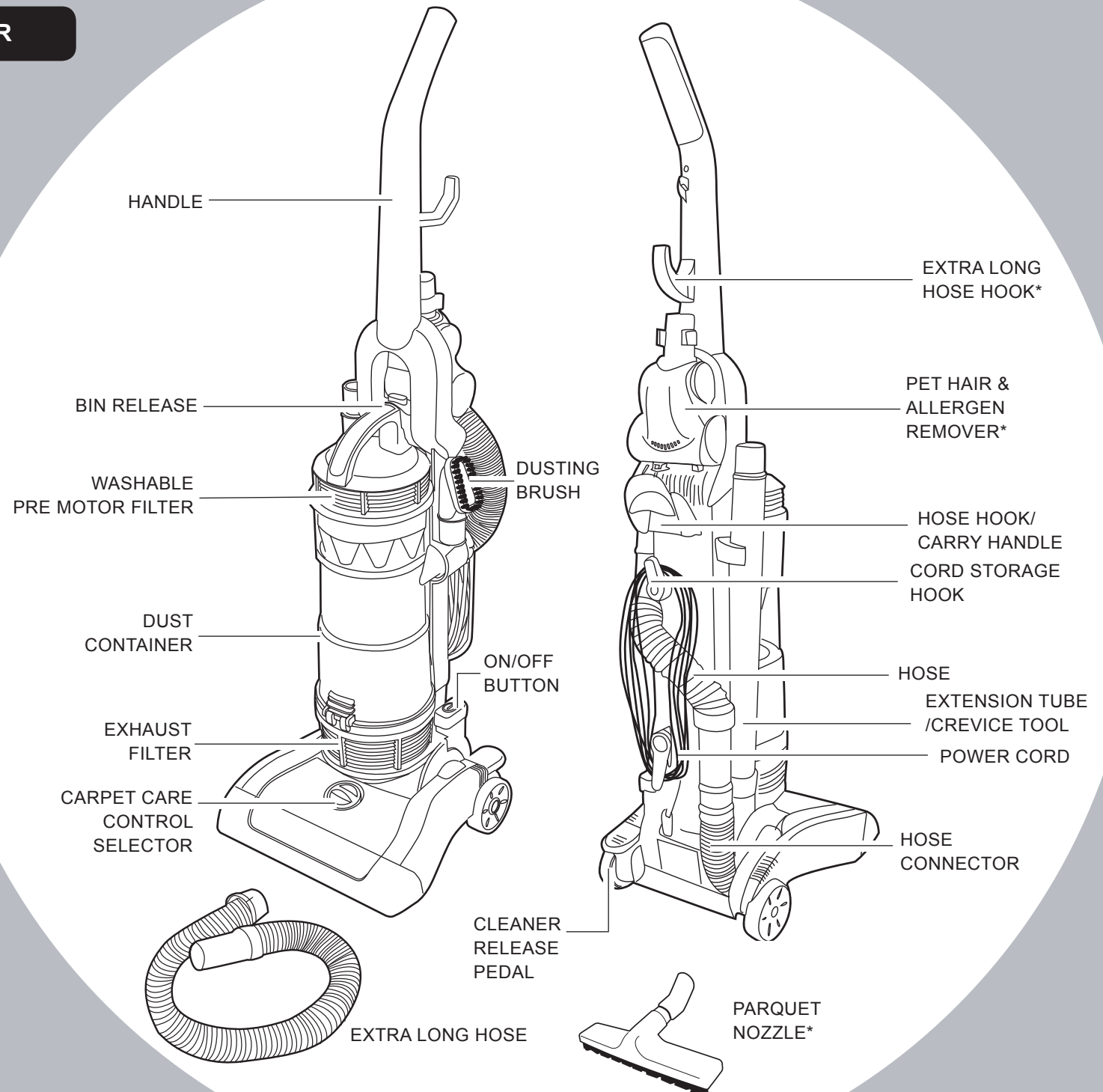

* Certain models only

PREPARING YOUR CLEANER

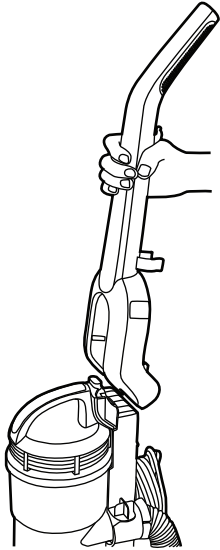

1 Insert the handle into the body of the cleaner.

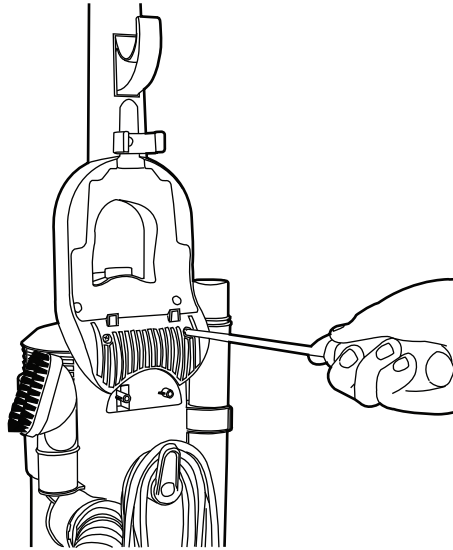

2 Screw handle in place with the screws provided.

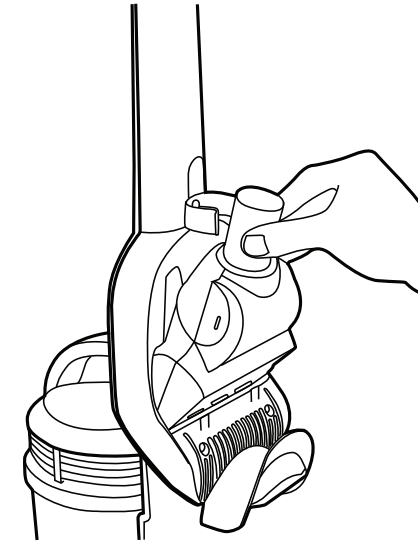

3 Attach turbo nozzle to the cleaner.

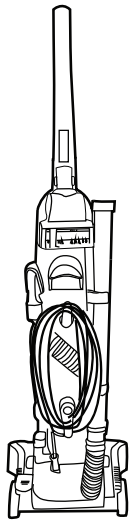

4 Ready for use

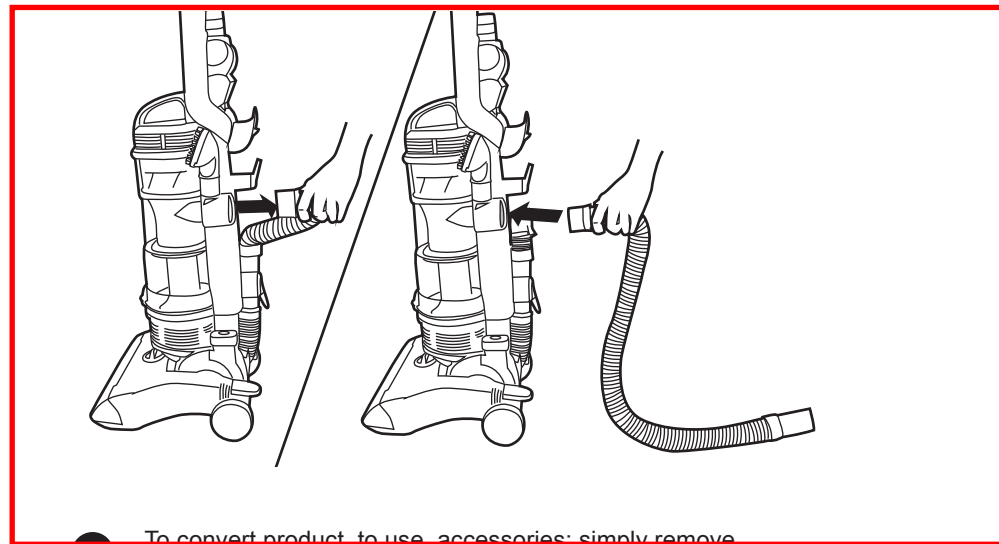

* ~~To convert product to use accessories: simply remove short hose and attach extra long hose in same locations.~~

* Certain models only.

CARPET CARE CONTROL SELECTOR

The carpet care control selector raises and lowers the height of the nozzle.

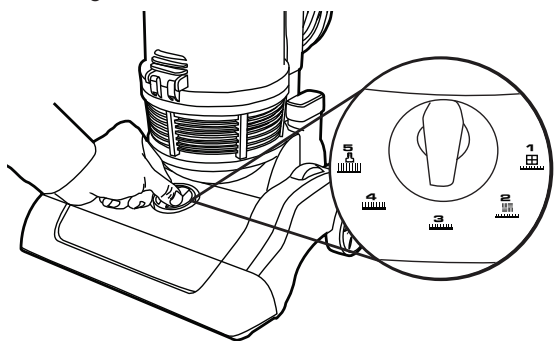

Ensure that the cleaner is in the upright (parked) position and move the selector to the required setting for the carpet type or floor covering.

To obtain the best performance and energy efficiency^{#1} it is recommended that the adjustment setting position 1 is used for the main cleaning operations. The other adjustment settings are for ease of use, use on longer pile carpets, or for specialist cleaning tasks.

Settings

1. Best performance and energy efficiency, short to medium pile carpets, hard wooden floors, wooden floor boards with crevices, ceramic tiles.
2. Medium pile carpets, delicate floor coverings such as vinyl or linoleum, parquet flooring.
- 3 or 4. For longer pile carpets the motion resistance may increase. Use these intermediate settings to reduce the force required to push the vacuum cleaner.
5. Luxury carpet and Tool mode

IMPORTANT: Using this cleaner for loop pile carpets with pile greater than 30mm is not recommended. Please consult the floorcare/carpet manufacturer's recommended cleaning instruction before vacuuming.

IMPORTANT: When cleaning delicate hard floors such as vinyl or linoleum the selector switch must

CARPET CARE CONTROL SELECTOR

be moved to position 2. Failure to do so may cause damage to the floor surface.

This vacuum cleaner is supplied with an Energy Label as required by European Regulation (EU) 665/2013. If the label shows a red prohibition circle on the right covering the hard floor symbol, then this indicates that the vacuum cleaner is not suitable for use on hard floors.

#1NOTE: Dust pick up ability carpet, dust pick up ability hard floor, and energy efficiency in accord with Commission Regulations (EU) 665/2013 and (EU) 666/2013.

CLEANER RELEASE

Unlock the cleaner by pressing down on the pedal with your foot.

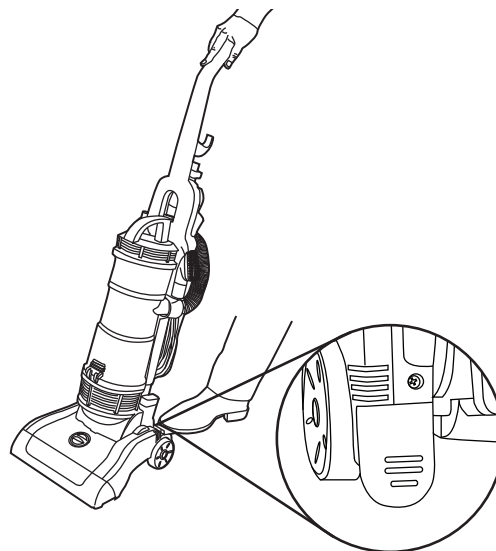

POWER SWITCH

To switch the cleaner on or off press down on the pedal with your foot.

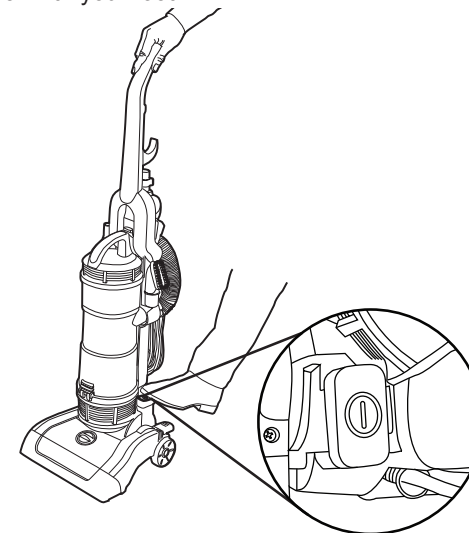

CLEANER STORAGE

Turn the cleaner off and remove the plug. Wrap the cord around the cord storage hooks.

For quick release of the full length of the power cord, rotate the top storage hook.

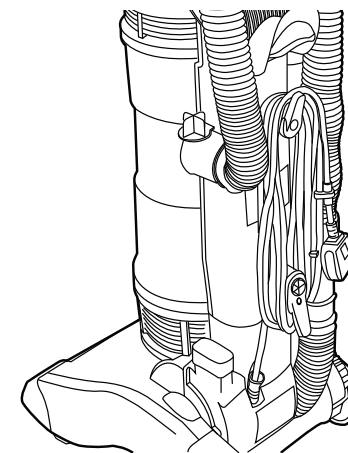

* Certain models only.

CLEANING TOOLS*

Crevice Tool

For corners and hard to reach areas.

Dusting Brush

For bookshelves, frames, keyboards and other delicate areas.

Pet Hair & Allergen Remover*

The pet hair & allergen remover is ideal for removing pets hairs. DO NOT touch the rotating brush.

Parquet Nozzle*

The parquet nozzle is ideal for cleaning delicate surfaces.

All accessories can fit onto the end of the flexible hose or end of the extension tube. Combine accessories depending on use.

- 1 Remove the short stretch hose from the Hose socket. Plug in the extra long hose in the hose socket.
- 2 Remove the extension tube.
- 3 Slide the crevice tool out of the extension tube.

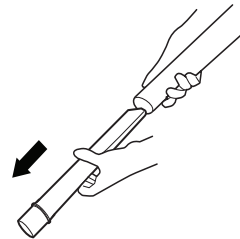
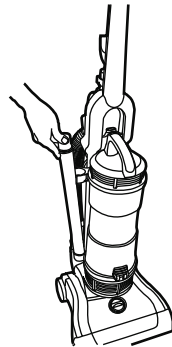
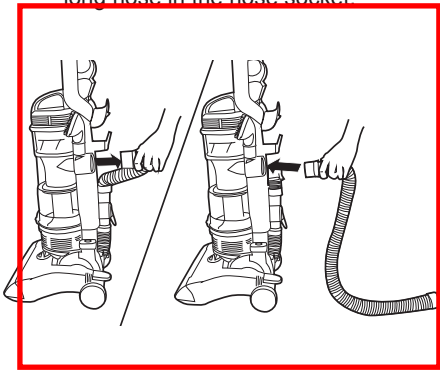

- 4 Attach extension tube to the end of the hose.
- 5 Fit the crevice tool or dusting brush to the extension tube or hose.

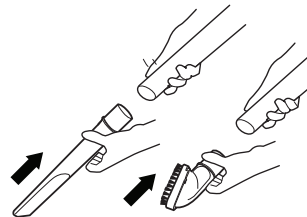
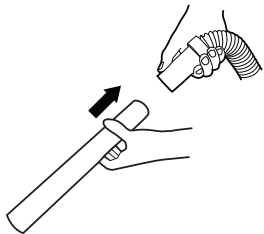

- 6 Fit the Pet Hair and Allergen Remover* to the hose or at the end of the extension tube. Fit the parquet nozzle* to the crevice tool.

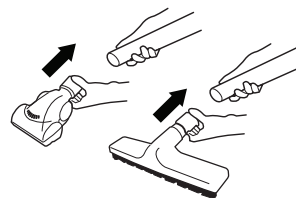

! IMPORTANT! When using cleaning tools, the cleaner must be kept in the upright position, particularly when cleaning stairs. The nozzle height should also be set to tool mode.

* Certain models only

- 6 -

CLEANING THE STAIRS

Both short and extra long hoses are supplied with the cleaner. When the user needs to use the longer stretch hose, the short hose should be removed from the hose socket and replaced by the longer stretch hose.

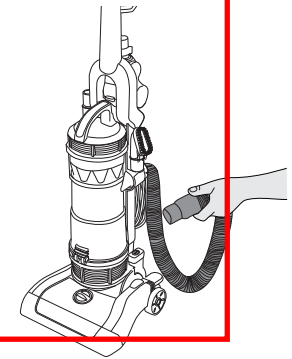

It is dangerous to place the cleaner above you when cleaning stairs.

ALWAYS work with the cleaner below you. Ensure it is positioned up against the bottom step.

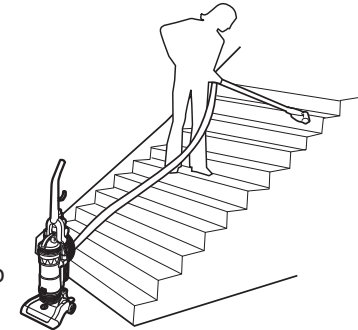

LONGER LENGTH HOSE HOOK*

For longer length hose*. Use the upper hose hook for storage.

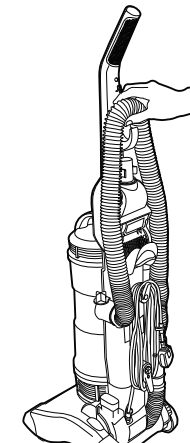

EMPTYING THE DUST CONTAINER

- 1 To remove the dust container from the cleaner press the bin release button.

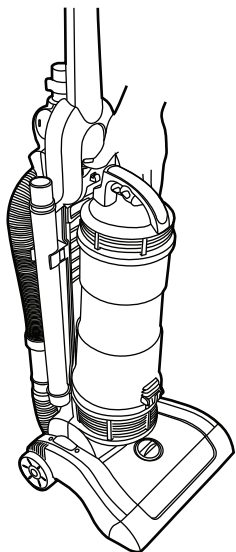

- 2 Hold the container over the bin and press the bin open button.

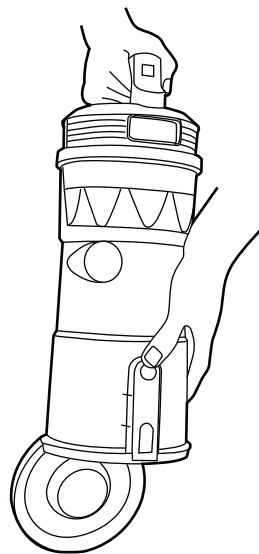

- 3 The dust container door will open and you can empty with no contact with the dust.

- 4 Once emptied, gently tap or shake the container to release any excess dust from the filters.

CLEANING THE PRE MOTOR FILTERS

- 1 Rotate the upper part of the dust bin to open.

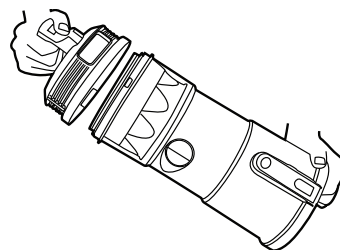

- 2 Remove the filter assembly from the dust bin.

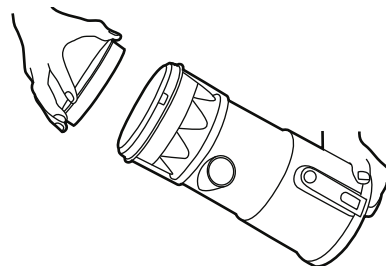

- 3 Separate the foam filter from the filter pack.

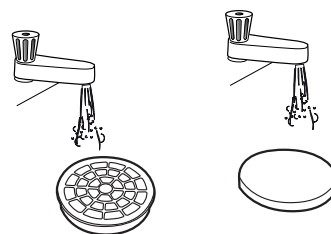

- 4 Wash both filters under hand warm water until the water runs clean. Remove excess water by shaking and leave to dry for 24 hours. When completely dry reassemble and refit filters to cleaner.

CLEANING THE EXHAUST FILTER

- 1 Remove the dust container rotate and remove the exhaust filter cover.

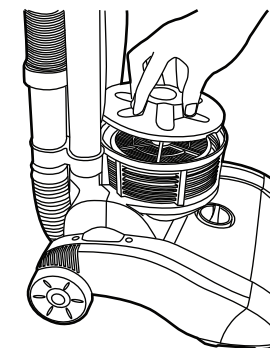

- 2 Remove the exhaust filter.

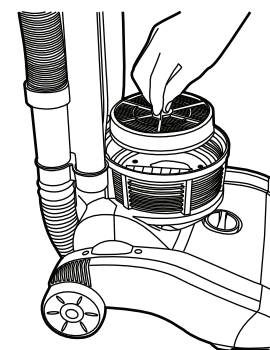

- 3 Wash the filter under hand warm water until the water runs clean. Remove excess water by shaking and leave to dry for 24 hours. When completely dry reassemble and refit filters to cleaner.

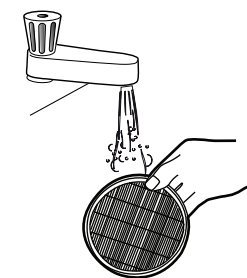

CHANGING THE BELT OR BRUSHES

If your cleaner is not picking up efficiently, the belt or brushes (or both) may need replacing, but first please make sure you have:

- Emptied the dust container
- Cleaned the filters
- Checked for blockages

IMPORTANT: Switch the cleaner off and remove the plug from the electricity supply before dismantling cleaner

- 1 Turn the cleaner over and remove 5 retaining screws attaching the brush guard to the base.

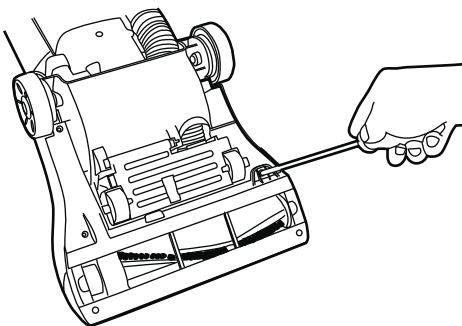

- 2 Remove the brush guard

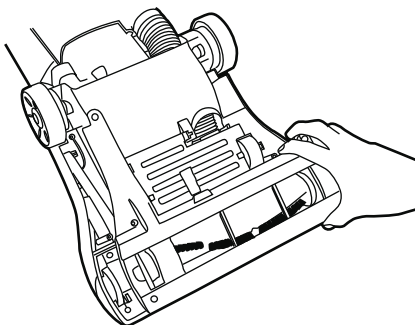

- 3 Remove brush assembly and check for wear on the belt. Loop the new belt around the motor and brush channel.

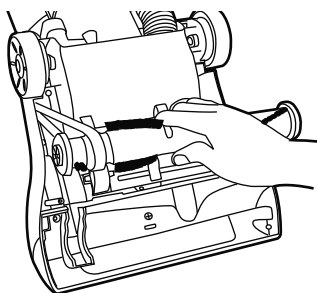

- 4 Hold the brush assembly and stretch the belt until the brush can be slotted back into the cleaner housing.

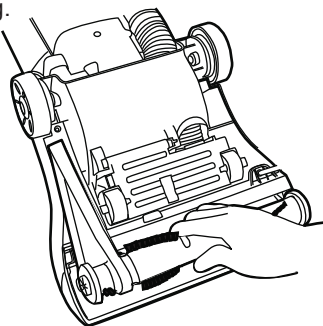

- 5 Rotate the brush to ensure movement of the belt.

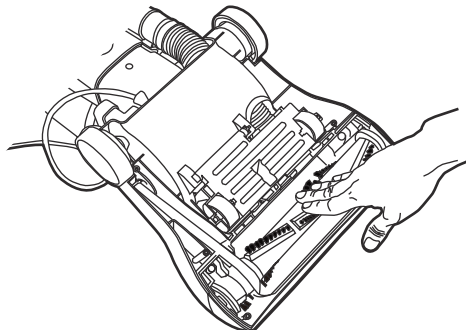

- 6 Refit the brush guard with 5 retaining screws.

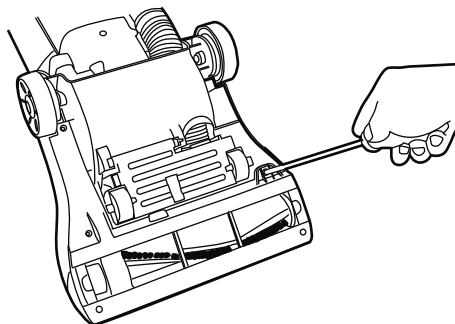

CLEARING A BLOCKAGE

IMPORTANT: Switch the cleaner off and remove the plug from the electricity supply before dismantling cleaner

If cleaning tools were in use check the cleaning tool and the removable handle.

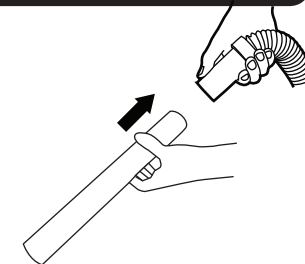

Check the hose by removing it from the cleaner, stretching it to full length.

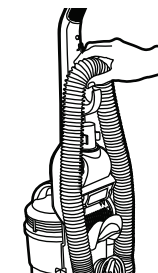

Turn the cleaner over and rotate the brushes until they are free to rotate.

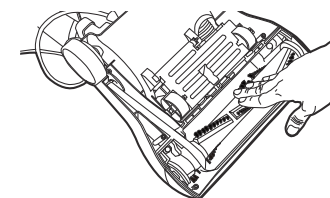

Check for a blockage in the hose socket. Use a flexible rod to remove any obstruction.

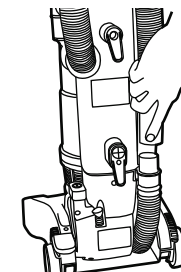

Removing a blockage from the pet hair & allergen remover.

Open the nozzle at each side, lift cover and remove the blockage.

*Certain models only.

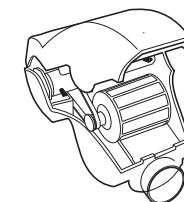

User checklist

If your cleaner is not working properly run through the following checklist.

1. Is there a working electricity supply to the cleaner?
Check with another electrical product.
2. Is the dust container full or choked with fine dust?
To empty the dust container, see instructions on P7.
3. Is the hose blocked?
To clear a blockage, see instructions on P8.
4. Is there a blockage in the cleaner base?
To clear a blockage, see the instruction on P8.
5. Are the filters blocked?
To clean filters, see the instruction on P7.
6. Is the nozzle height set correctly?
To set the carpet height selector, see the instruction on p4.
7. Are the brushes rotating correctly?
To check the brushes, see the instructions on p8.
8. Has the cleaner overheated?
If so, it will take about 30 minutes to reset.

If there is any doubt call the Hoover Service Office for advice. They may be able to assist you over the telephone. A service charge will be made if the cleaner is examined and found to be in working order, has not been assembled in accordance with these instructions or has been used incorrectly. working order, has not been assembled in accordance with these instructions or has been used incorrectly.

WARNING!

A thermal cut out switches off the cleaner to prevent overheating if it is used when full or there is a blockage or dirty filters. If this should happen switch off, unplug and correct the fault.

It will take about 45 minutes for the cut out to automatically reset.

IMPORTANT: Do not run cleaner over the supply cord as this could damage the supply cord insulation.

IMPORTANT INFORMATION

Hoover Service

Should you require service at any time, please contact your local Hoover Service Office.

Hoover spares and Consumables

Always replace parts with genuine Hoover spares. These are available from your local Hoover dealer or direct from Hoover. When ordering parts always quote your model number.

USE ONLY HOOVER SPARES

SPARE PARTS	CODE
AGITATOR	Y200E 35601611
BELT	V200E 35601615
HOSE	D130 35601199
PET HAIR AND ALLERGEN REMOVER	J44 35601064
HARD FLOOR CARESSE NOZZLE	G135 PC 35601201

CONSUMABLES	CODE
FILTER KIT (PRE MOTOR AND EXHAUST)	U65 35601202

Quality

Hoover's factories have been independently assessed for quality. Our products are made using a quality system which meets the requirements of ISO 9001

GUARANTEE STATEMENT

The guarantee conditions for this appliance are as defined by our representative in the country in which it is sold. Details regarding these conditions can be obtained from the dealer from whom the appliance was purchased. The bill of sale or receipt must be produced when making any claim under the terms of this guarantee. Subject to change without notice.



GENERATION FUTURE

Hoover Limited
Pentrebach
Merthyr Tydfil
Mid Glamorgan
CF48 4TU

HOOVER CUSTOMER HELPLINE
08444 995 599

© 2014 48011580/01