

SAMSUNG

SM-T330

User Manual

About this manual

This device provides high quality mobile communication and entertainment using Samsung's high standards and technological expertise. This user manual is specially designed to detail the device's functions and features.

- Please read this manual before using the device to ensure safe and proper use.
- Descriptions are based on the device's default settings.
- Images and screenshots may differ in appearance from the actual product.
- Content may differ from the final product, or from software provided by service providers or carriers, and is subject to change without prior notice. For the latest version of the manual, refer to the Samsung website, www.samsung.com.
- Content (high quality content) that requires high CPU and RAM usage will affect the overall performance of the device. Applications related to the content may not work properly depending on the device's specifications and the environment that it is used in.
- Available features and additional services may vary by device, software, or service provider.
- Applications and their functions may vary by country, region, or hardware specifications. Samsung is not liable for performance issues caused by applications from any provider other than Samsung.
- Samsung is not liable for performance issues or incompatibilities caused by edited registry settings or modified operating system software. Attempting to customise the operating system may cause the device or applications to work improperly.
- Software, sound sources, wallpapers, images, and other media provided with this device are licensed for limited use. Extracting and using these materials for commercial or other purposes is an infringement of copyright laws. Users are entirely responsible for illegal use of media.
- Default applications that come with the device are subject to updates and may no longer be supported without prior notice. If you have questions about an application provided with the device, contact a Samsung Service Centre. For user-installed applications, contact service providers.
- Modifying the device's operating system or installing softwares from unofficial sources may result in device malfunctions and data corruption or loss. These actions are violations of your Samsung licence agreement and will void your warranty.

Instructional icons



Warning: situations that could cause injury to yourself or others



Caution: situations that could cause damage to your device or other equipment



Note: notes, usage tips, or additional information

Copyright

Copyright © 2015 Samsung Electronics

This guide is protected under international copyright laws.

No part of this guide may be reproduced, distributed, translated, or transmitted in any form or by any means, electronic or mechanical, including photocopying, recording, or storing in any information storage and retrieval system, without the prior written permission of Samsung Electronics.

Trademarks

- SAMSUNG and the SAMSUNG logo are registered trademarks of Samsung Electronics.
- Bluetooth® is a registered trademark of Bluetooth SIG, Inc. worldwide.
- Wi-Fi®, Wi-Fi Protected Setup™, Wi-Fi Direct™, Wi-Fi CERTIFIED™, and the Wi-Fi logo are registered trademarks of the Wi-Fi Alliance.
- All other trademarks and copyrights are the property of their respective owners.

Table of Contents

Getting started

- 7 Device layout
- 8 Buttons
- 9 Package contents
- 10 Charging the battery
- 12 Inserting a memory card
- 14 Turning the device on and off
- 15 Holding the device
- 15 Locking and unlocking the device
- 15 Adjusting the volume
- 15 Switching to silent mode

Basics

- 16 Indicator icons
- 17 Using the touch screen
- 20 Control motions
- 22 Using Multi Window
- 26 Notifications
- 27 Home screen
- 29 Applications screen
- 30 Using applications
- 31 Help
- 31 Entering text

- 33 Connecting to a Wi-Fi network
- 34 Setting up accounts
- 35 Multiple users
- 37 Transferring files
- 38 Securing the device
- 39 Upgrading the device

Communication

- 40 Contacts
- 44 Email
- 46 Gmail
- 48 Hangouts
- 48 Google+
- 49 Photos

Web & network

- 50 Internet
- 51 Chrome
- 52 Bluetooth
- 53 Screen Mirroring

Media

- 54 Music
- 56 Camera
- 62 Gallery
- 65 Video
- 66 YouTube

Application & media stores

- 67 Play Store
- 68 Galaxy Apps
- 68 Play Books
- 69 Play Movies & TV
- 69 Play Music
- 69 Play Games
- 69 Play Newsstand

Utilities

- 70 Memo
- 71 S Planner
- 73 Dropbox
- 74 Cloud
- 75 Drive
- 75 Hancom Office Viewer
- 78 Alarm
- 79 World clock
- 79 Calculator
- 80 S Voice
- 81 Google
- 81 Voice Search
- 82 My Files

Travel & local

- 84 Maps

Settings

- 85 About Settings
- 85 CONNECTIONS
- 88 DEVICE
- 92 CONTROLS
- 94 GENERAL
- 97 Google Settings

Troubleshooting

Getting started



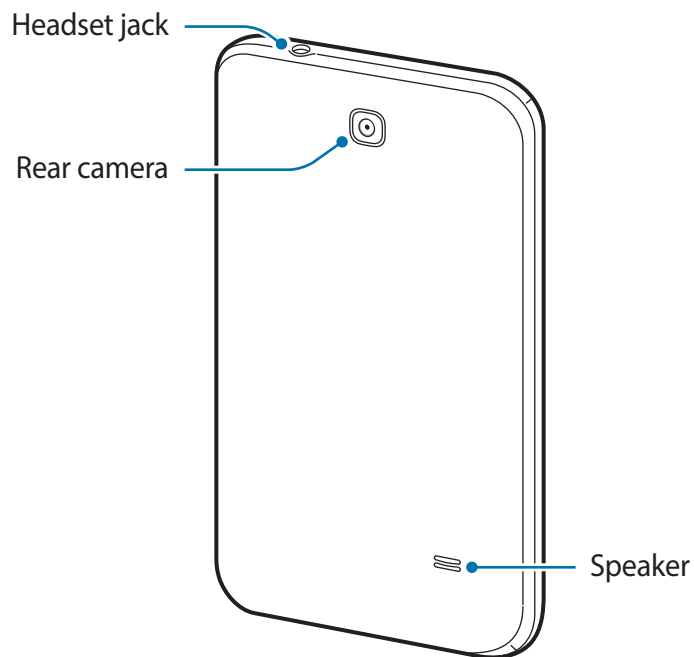
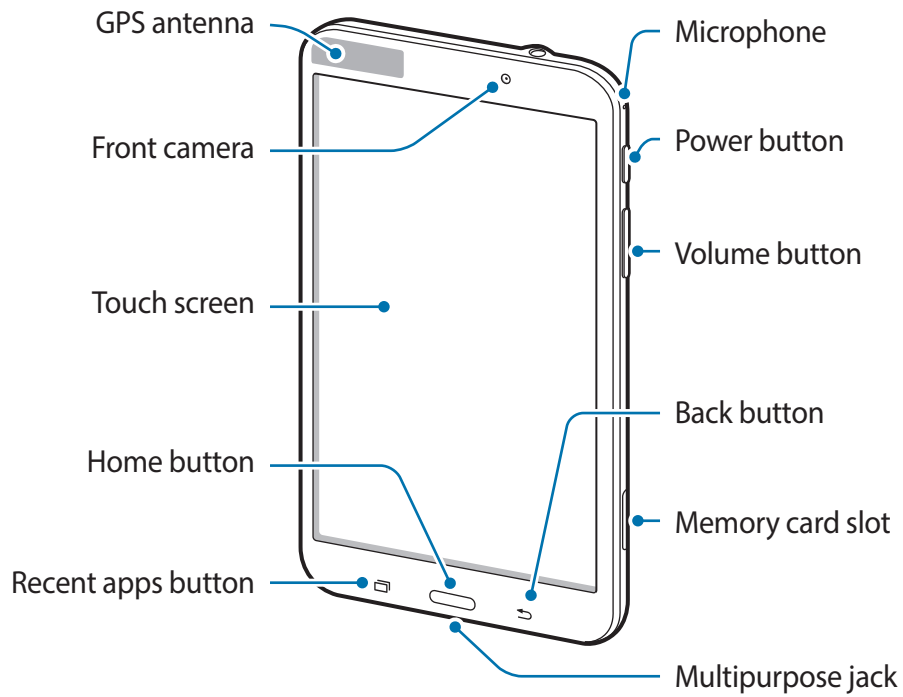

Device layout





- Do not cover the antenna area with your hands or other objects. This may cause connectivity problems or drain the battery.
- Using a Samsung-approved screen protector is recommended. Unapproved screen protectors may cause the sensors to malfunction.
- Do not allow water to contact the touch screen. The touch screen may malfunction in humid conditions or when exposed to water.

Buttons

Button	Function
 Power	<ul style="list-style-type: none"> • Press and hold to turn the device on or off. • Press and hold for more than 7 seconds to reset the device if it has fatal errors or hang-ups, or freezes. • Press to lock or unlock the device. The device goes into lock mode when the touch screen turns off.
 Recent apps	<ul style="list-style-type: none"> • Tap to open the list of recent applications.
 Home	<ul style="list-style-type: none"> • Press to return to the Home screen. • Press and hold to launch Google search.
 Back	<ul style="list-style-type: none"> • Tap to return to the previous screen.
 Volume	<ul style="list-style-type: none"> • Press to adjust the device volume.

Package contents

Check the product box for the following items:

- Device
- Quick start guide



- The items supplied with the device and any available accessories may vary depending on the region or service provider.
- The supplied items are designed only for this device and may not be compatible with other devices.
- Appearances and specifications are subject to change without prior notice.
- You can purchase additional accessories from your local Samsung retailer. Make sure they are compatible with the device before purchase.
- Other accessories may not be compatible with your device.
- Use only Samsung-approved accessories. Malfunctions caused by using unapproved accessories are not covered by the warranty service.
- Availability of all accessories is subject to change depending entirely on manufacturing companies. For more information about available accessories, refer to the Samsung website.

Charging the battery

Use the charger to charge the battery before using it for the first time.



Use only Samsung-approved chargers, batteries, and cables. Unapproved chargers or cables can cause the battery to explode or damage the device.



- When the battery power is low, the battery icon appears empty.
- If the battery is completely discharged, the device cannot be turned on immediately when the charger is connected. Allow a depleted battery to charge for a few minutes before turning on the device.
- If you use multiple applications at once, network applications, or applications that need a connection to another device, the battery will drain quickly. To avoid disconnecting from the network or losing power during a data transfer, always use these applications after fully charging the battery.

Charging with the charger

Connect the USB cable to the USB power adaptor and then plug the end of the USB cable into the multipurpose jack.

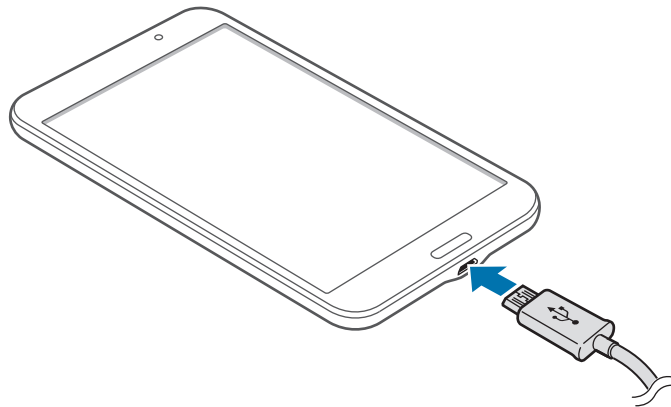

Connecting the charger improperly may cause serious damage to the device. Any damage caused by misuse is not covered by the warranty.



- The device can be used while it is charging, but it may take longer to fully charge the battery.
- If the device receives an unstable power supply while charging, the touch screen may not function. If this happens, unplug the charger from the device.
- While charging, the device may heat up. This is normal and should not affect the device's lifespan or performance. If the battery gets hotter than usual, the charger may stop charging.
- If the device is not charging properly, take the device and the charger to a Samsung Service Centre.

After fully charging, disconnect the device from the charger. First unplug the charger from the device, and then unplug it from the electric socket.



To save energy, unplug the charger when not in use. The charger does not have a power switch, so you must unplug the charger from the electric socket when not in use to avoid wasting power. The charger should remain close to the electric socket and easily accessible while charging.

Checking the battery charge status

When you charge the battery while the device is off, the following icons will show the current battery charge status:



Charging



Fully charged

Reducing the battery consumption

Your device provides options that help you save battery power. By customising these options and deactivating features in the background, you can use the device longer between charges:

- When you are not using the device, switch to sleep mode by pressing the Power button.
- Close unnecessary applications with the task manager.
- Deactivate the Bluetooth feature.
- Deactivate the Wi-Fi feature.
- Deactivate auto-syncing of applications.
- Decrease the backlight time.
- Decrease the brightness of the display.

Inserting a memory card

Your device accepts memory cards with maximum capacities of 64 GB. Depending on the memory card manufacturer and type, some memory cards may not be compatible with your device.



- Some memory cards may not be fully compatible with the device. Using an incompatible card may damage the device or the memory card, or corrupt the data stored in it.
- Use caution to insert the memory card right-side up.



- The device supports the FAT and the exFAT file systems for memory cards. When inserting a card formatted in a different file system, the device asks to reformat the memory card.
- Frequent writing and erasing of data shortens the lifespan of memory cards.
- When inserting a memory card into the device, the memory card's file directory appears in the **SD card** folder.

- 1 Open the cover of the memory card slot.
- 2 Insert a memory card with the gold-coloured contacts facing downwards.
- 3 Push the memory card into the slot until it locks in place.

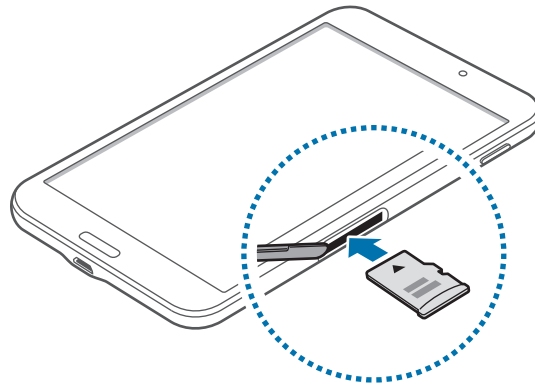

- 4 Close the cover of the memory card slot.

Removing the memory card

Before removing the memory card, first unmount it for safe removal. On the Home screen, tap  → **Settings** → **GENERAL** → **Storage** → **Unmount SD card**.

- 1 Open the cover of the memory card slot.
- 2 Push the memory card until it disengages from the device, and then pull it out.
- 3 Close the cover of the memory card slot.

 Do not remove the memory card while the device is transferring or accessing information. Doing so can cause data to be lost or corrupted or damage to the memory card or device. Samsung is not responsible for losses that result from the misuse of damaged memory cards, including the loss of data.

Formatting the memory card

A memory card formatted on a computer may not be compatible with the device. Format the memory card on the device.

On the Home screen, tap  → **Settings** → **GENERAL** → **Storage** → **Format SD card** → **FORMAT SD CARD** → **ERASE EVERYTHING**.



Before formatting the memory card, remember to make backup copies of all important data stored on the device. The manufacturer's warranty does not cover loss of data resulting from user actions.

Turning the device on and off

When turning on the device for the first time, follow the on-screen instructions to set up your device.

Press and hold the Power button for a few seconds to turn on the device.

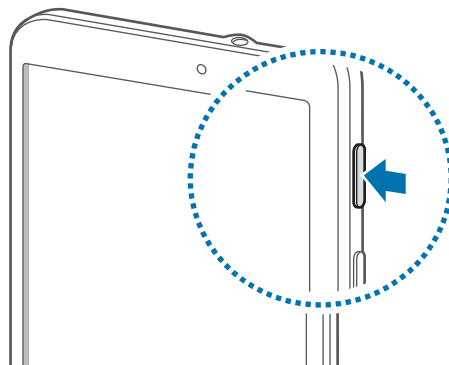

- Follow all posted warnings and directions from authorised personnel in areas where the use of wireless devices is restricted, such as aeroplanes and hospitals.
- Press and hold the Power button and tap **Flight mode** to disable the wireless features.

To turn off the device, press and hold the Power button, and then tap **Power off**.

Holding the device

Do not cover the antenna area with your hands or other objects. This may cause connectivity problems or drain the battery.

Locking and unlocking the device

When not in use, lock the device to prevent unwanted operation. Pressing the Power button turns off the screen and puts the device into lock mode. The device automatically gets locked if it is not used for a specified period.

To unlock the device, press the Power button or the Home button when the touch screen is turned off, tap anywhere on the screen, and then flick your finger in any direction.

Adjusting the volume

Press the Volume button up or down to adjust the ringtone volume, or to adjust the sound volume when playing music or video.

Switching to silent mode









Use one of the following methods:

- Press and hold the Volume button down until it switches to silent mode.
- Open the notifications panel at the top of the screen, and then tap **Sound**.

Basics

Indicator icons

The icons displayed at the top of the screen provide information about the status of the device. The icons listed in the table below are most common.

Icon	Meaning
	Wi-Fi connected
	Bluetooth feature activated
	GPS activated
	Synced with the web
	Alarm activated
	Mute mode activated
	Flight mode activated
	Error occurred or caution required
	Battery power level

Using the touch screen

Use only fingers to use the touch screen.



- Do not allow the touch screen to come into contact with other electrical devices. Electrostatic discharges can cause the touch screen to malfunction.
- To avoid damaging the touch screen, do not tap it with anything sharp or apply excessive pressure to it with your fingertips.



- The device may not recognise touch inputs close to the edges of the screen, which are outside of the touch input area.
- Leaving the touch screen idle for extended periods may result in afterimages (screen burn-in) or ghosting. Turn off the touch screen when you do not use the device.

Finger gestures

Tapping

To open an application, to select a menu item, to press an on-screen button, or to enter a character using the on-screen keyboard, tap it with a finger.

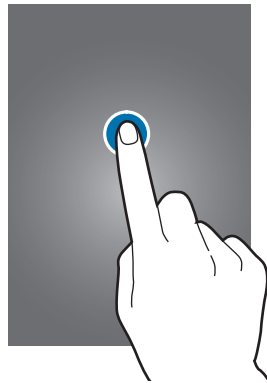

Tapping and holding

Tap and hold an item for more than 2 seconds to access available options.



Dragging

To move an icon, thumbnail, or preview to a new location, tap and hold it and drag it to the target position.

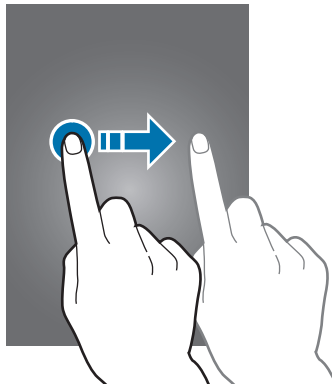

Double-tapping

Double-tap on a webpage or image to zoom in a part. Double-tap again to return.

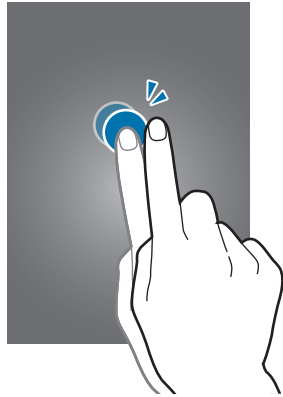

Flicking

Flick left or right on the Home screen or the Applications screen to see another panel. Flick up or down to scroll through a webpage or a list, such as contacts.

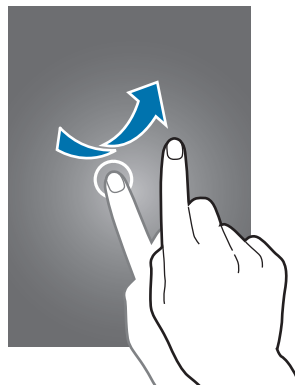

Pinching

Spread two fingers apart on a webpage, map, or image to zoom in a part. Pinch to zoom out.

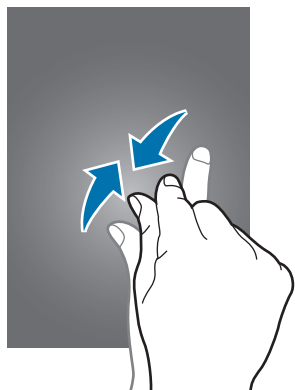

Control motions

Simple motions allow easy control of the device.

Before using motions, make sure the motion feature is activated. On the Home screen, tap  → **Settings** → **CONTROLS** → **Palm motion**, and then drag the **Palm motion** switch to the right.



Excessive shaking or impact to the device may result in unintended inputs. Control motions properly.

Rotating the screen

Many applications allow display in either portrait or landscape orientation. Rotating the device causes the display to automatically adjust to fit the new screen orientation.

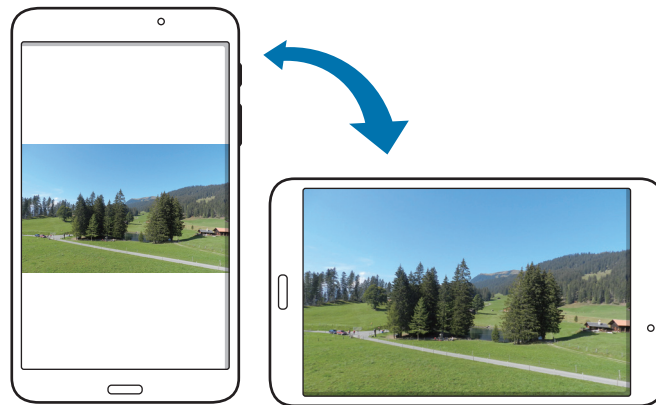

To prevent the display from rotating automatically, open the notifications panel and deselect **Screen rotation**.



- Some applications do not allow screen rotation.
- Some applications display a different screen depending on the orientation.

Sweeping

Sweep your hand across the screen to capture a screenshot. The image is saved in **Gallery** → **Screenshots**. It is not possible to capture a screenshot while using some applications.

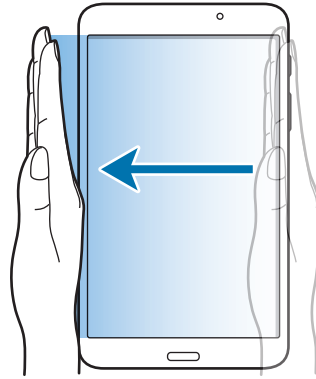

Covering

Cover the screen with a palm to pause media playback.

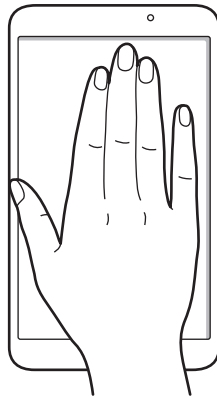

Using Multi Window

Use this feature to run multiple applications on the screen at the same time.



- Only applications on the Multi Window tray can run.
- This feature may not be available depending on the region or service provider.

To use Multi Window, on the Home screen, tap  → **Settings** → **DEVICE** → **Multi window**, and then drag the **Multi window** switch to the right.

Using a split screen Multi Window

Use this feature to run applications in a split screen.

Launching applications in a split screen Multi Window

- 1 Drag your finger from the right edge of the screen towards the middle of the screen. Alternatively, tap and hold .

The Multi Window tray appears at the right side of the screen.

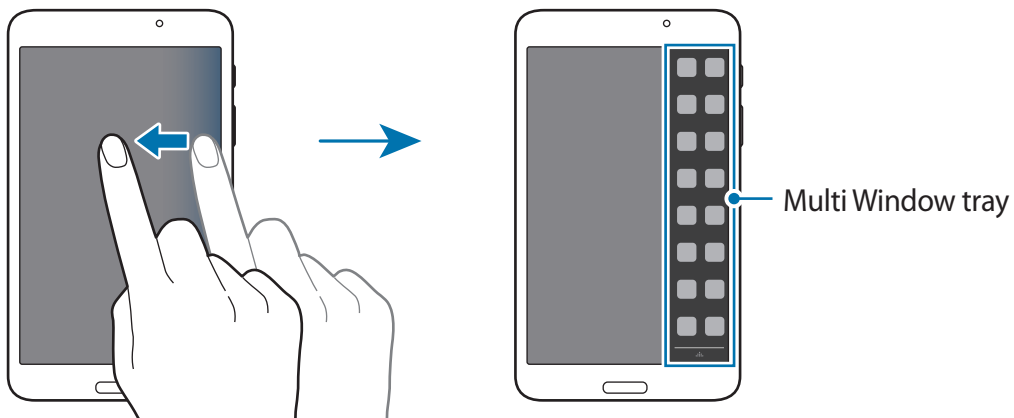

- 2 Tap and hold an application icon on the Multi Window tray, and then drag it to the screen. Release the application icon when the screen turns blue.

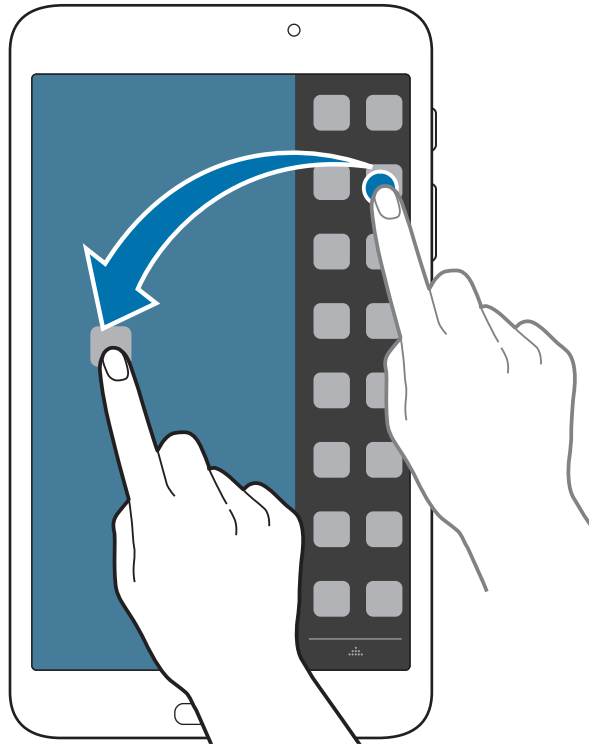

- 3 Tap and hold another application icon on the Multi Window tray, and then drag it to a new location.

Sharing content between applications

You can easily share content between applications, such as **Email** and **Internet**, by dragging and dropping them.



Some applications may not support this feature.

- 1 Launch **Email** and **Internet** in a split screen Multi Window.

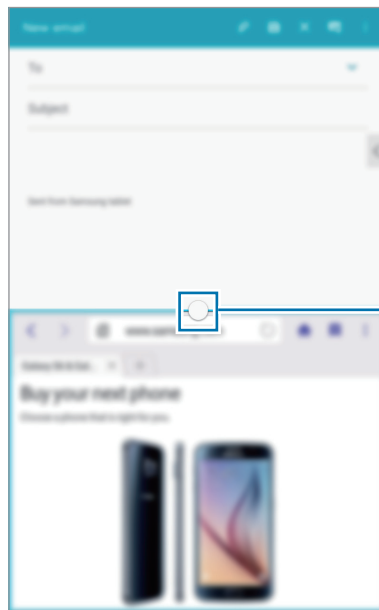





Access the Multi Window options.

- 2 Tap the circle between the application windows, and then tap .



Tap the circle between application windows to access the following options:

-  : Switch locations between Multi Window applications.
-  : Share items, such as images, text, or links, between application windows by dragging and dropping them.
-  : Maximise the window.
-  : Close the application.

- 3 Tap and hold an item in the Internet window and drag it to a location in the Email window.



Notifications



Notification icons appear on the status bar at the top of the screen to report new messages, calendar events, device status, and more. Drag down from the status bar to open the notifications panel. Scroll the list to see additional alerts. To close the notifications panel, drag up the bar that is at the bottom of the screen.

From the notifications panel, you can view your device's current settings. Drag down from the status bar, and then tap  to use the following options:

- **Wi-Fi:** Activate or deactivate the Wi-Fi feature.
- **Location:** Activate or deactivate the GPS feature.
- **Sound:** Activate or deactivate silent mode.
- **Screen rotation:** Allow or prevent the interface from rotating when you rotate the device.
- **Bluetooth:** Activate or deactivate the Bluetooth feature.
- **Multi window:** Set the device to use Multi Window.
- **Screen Mirroring:** Activate or deactivate the screen mirroring feature.
- **Sync:** Activate or deactivate auto-syncing of applications.
- **Smart stay:** Activate or deactivate the smart stay feature.
- **Power saving:** Activate or deactivate power-saving mode.
- **Flight mode:** Activate or deactivate flight mode.



The available options may vary depending on the region or service provider.

To rearrange the options on the notifications panel, open the notifications panel, tap  → , tap and hold an item, and then drag the item to another location.

Home screen

The Home screen is the starting point to access all of the device's features. It displays indicator icons, widgets, shortcuts to applications, and others.

The Home screen can have multiple panels. To view other panels, scroll left or right.

Rearranging items

Adding an application icon

On the Home screen, tap , tap and hold an application icon, and then drag it into a panel preview.

Moving an item

Tap and hold an item and drag it to a new location. To move it to another panel, drag it to the side of the screen.

Removing an item

Tap and hold an item, and drag it to the rubbish bin that appears at the top of the Home screen. When the rubbish bin turns red, release the item.

Rearranging panels

Adding a new panel

Pinch on the screen and tap .

Moving a panel

Pinch on the screen, tap and hold a panel preview, and then drag it to a new location.

Removing a panel

Pinch on the screen, tap and hold a panel preview, and then drag it to the rubbish bin at the top of the screen.

Setting wallpaper

Set an image or photo stored in the device as wallpaper for the Home screen.

- 1 On the Home screen, tap and hold an empty area, and then tap **Wallpapers** → **Home screen**.
- 2 Scroll left or right and select from images displayed at the bottom of the screen.
To select photos taken by the device's camera or other images, tap **From Gallery**.
- 3 Tap **SET AS WALLPAPER** or **DONE**.

Using widgets

Widgets are small applications that provide convenient functions and information on your Home screen. To use them, add widgets from the widgets panel to the Home screen.



- Some widgets connect to web services. Using a web-based widget may result in additional charges.
- The widgets available may vary depending on the region or service provider.

To add widgets, open the Home screen, tap and hold an empty area, tap **Widgets**, tap and hold a widget, and then drag it to the Home screen. Put it on a location you want, resize it by dragging the frame if necessary, and then tap anywhere on the screen to save the location of the widget.

Applications screen

The Applications screen displays icons for all applications, including any new applications installed.

On the Home screen, tap  to open the Applications screen.

To view other panels, scroll left or right.



Rearranging applications

This feature is available only in the customisable grid view.

Tap  → **Edit**, tap and hold an application, and then drag it to a new location. To move it to another panel, drag it to the side of the screen.

Organising with folders

Put related applications together in a folder for convenience.

Tap  → **Edit**, tap and hold an application, and then drag it to **Create folder**. Enter a folder name. Tap , select the applications to move to the folder, and then tap **DONE**.

The new folder is added to the folder panel of the Applications screen.

Rearranging panels

Pinch on the screen, tap and hold a panel preview, and then drag it to a new location.

Installing applications

Use application stores, such as **Galaxy Apps**, to download and install applications.

Uninstalling applications

Tap  → **Uninstall/disable apps**, and then select an application to uninstall it.



Default applications that come with the device cannot be uninstalled.

Disabling applications

Tap  → **Uninstall/disable apps**, and then select an application to disable it.

To enable the application, on the Applications screen, tap  → **Show disabled apps**, select the applications, and then tap **DONE**.



- Downloaded applications and some default applications that come with the device cannot be disabled.
- When you use this feature, disabled applications disappear from the Applications screen but are still stored in the device.

Using applications

This device can run many different types of applications, ranging from media to Internet applications.

Opening an application

On the Home screen or the Applications screen, select an application icon to open it.



Opening from recently-used applications

Tap  to open the list of recently-used applications.

Select an application icon to open.

Closing an application

Close applications not in use to save battery power and maintain device performance.

Tap  → **Active apps**, and then tap **END** next to an application to close it. To close all running applications, tap **END ALL**. Alternatively, tap  → **Close all**.

Help

Access help information to learn how to use the device and applications or configure important settings.

Tap **Help** on the Applications screen. Select a category to view tips.

To sort categories by an alphabetical order, tap  → **Sort by name**.

To search for keywords, tap .

Entering text

Use the Samsung keyboard or the voice input feature to enter text.



Text entry is not supported in some languages. To enter text, you must change the input language to one of the supported languages.

Changing the keyboard type

Tap any text field, open the notifications panel, tap **Select keyboard**, and then select the type of keyboard to use.

Using the Samsung keyboard

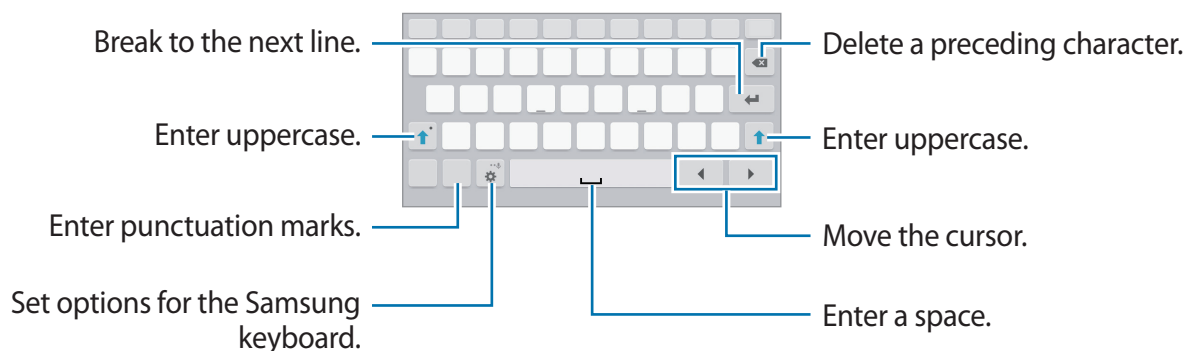

Entering uppercase

Tap  before entering a character. For all caps, tap it twice.

Changing the keyboard type



Tap and hold , and then tap  to change the keyboard type.

You can move the keyboard to another location by dragging the tab.



Changing language keyboards

Add languages to the keyboard, and then slide the space key left or right to change language keyboards.

Handwriting

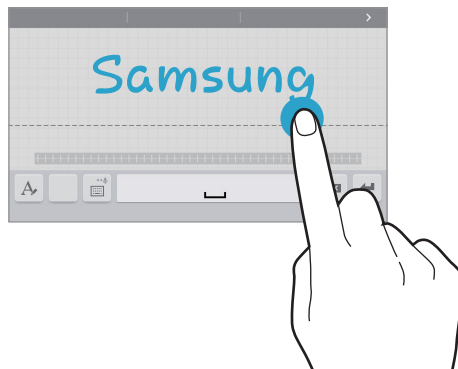
Tap and hold , tap , and then write a word with a finger. Suggested words appear as characters are entered. Select a suggested word.



Use handwriting gestures to perform actions, such as editing or deleting characters and inserting spaces. To view the gesture guides, tap and hold , and then tap  →  → **Help** → **Using handwriting gestures**.



This feature may not be available depending on the region or service provider.

Entering text by voice

Activate the voice input feature and then speak into the microphone. The device displays what you speak.

If the device does not recognise your words correctly, tap the underlined text and select an alternative word or phrase from the dropdown list.

To change the language or add languages for the voice recognition, tap .

Copying and pasting

Tap and hold over text, drag  or  to select more or less text, and then tap **Copy** to copy or **Cut** to cut. The selected text is copied to the clipboard.

To paste it into a text entry field, tap and hold at the point where it should be inserted, and then tap **Paste**.

Connecting to a Wi-Fi network

Connect the device to a Wi-Fi network to use the Internet or share media files with other devices. (p. 85)



Ensure that the Wi-Fi connection is active before using Internet applications.

Turning Wi-Fi on and off

Open the notifications panel, and then tap **Wi-Fi** to turn it on or off.



- Your device uses a non-harmonised frequency and is intended for use in all European countries. The WLAN can be operated in the EU without restriction indoors, but cannot be operated outdoors.
- Turn off Wi-Fi to save the battery when not in use.

Joining Wi-Fi networks

On the Applications screen, tap **Settings** → **CONNECTIONS** → **Wi-Fi**, and then drag the **Wi-Fi** switch to the right.

Select a network from the list of detected Wi-Fi networks, enter a password if necessary, and then tap **CONNECT**. Networks that require a password appear with a lock icon. After the device connects to a Wi-Fi network, the device will automatically connect to it any time it is available.

Adding Wi-Fi networks

If the desired network does not appear in the networks list, tap **Add Wi-Fi network** at the bottom of the networks list. Enter the network name in **Network SSID**, select the security type and enter the password if it is not an open network, and then tap **CONNECT**.

Forgetting Wi-Fi networks

Any network that has ever been used, including the current network, can be forgotten so the device will not automatically connect to it. Select the network in the networks list, and then tap **FORGET**.

Setting up accounts

Google applications, such as **Play Store**, require a Google account, and **Galaxy Apps** requires a Samsung account. Create Google and Samsung accounts to have the best experience with the device.

Adding accounts

Follow the instructions that appear when opening a Google application without signing in to set up a Google account.

To sign in with or sign up for a Google account, on the Applications screen, tap **Settings** → **GENERAL** → **Accounts** → **Add account** → **Google**. Then, follow the on-screen instructions to complete the account setup. More than one Google account can be used on the device.

Set up a Samsung account as well.

Removing accounts

On the Applications screen, tap **Settings** → **GENERAL** → **Accounts**, select an account name under **My accounts**, select the account to remove, and then tap  → **Remove account**.

Multiple users

Set up additional user accounts for other users to use the device with personalised settings, such as email accounts, wallpaper preferences, and more. Following types of user accounts are available.

- **Owner:** The owner account is created only when setting up the device for the first time, and cannot be created more than one. This account has full control of the device including user account management.
- **User:** This account allows users to access their own applications and content, and customise the device settings that affect all accounts.
- **Restricted profile:** A restricted account can only access the applications and content allowed by the owner account, and cannot use the services that require logging in.

Adding users

- 1 On the Applications screen, tap **Settings** → **GENERAL** → **Users**.
- 2 Tap **Add user or profile** → **User** → **OK** → **SET UP NOW**.
- 3 Follow the on-screen instructions to complete the account setup.

Adding restricted profiles

- 1 On the Applications screen, tap **Settings** → **GENERAL** → **Users**.
- 2 Tap **Add user or profile** → **Restricted profile**.
- 3 Set an unlock code, and then select the applications and content that restricted users are allowed to access.

Switching users

Tap  at the top of the locked screen. Select the account to switch to, and then unlock the device.

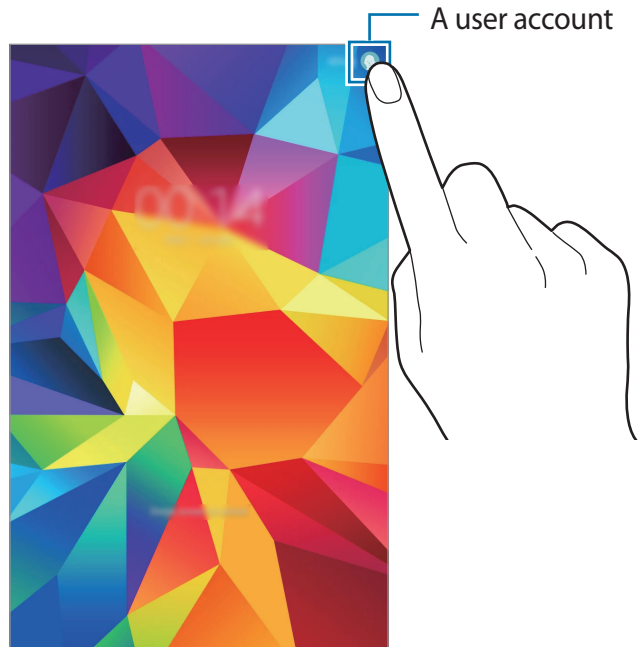

Managing users

When using the owner account, you can delete accounts or change the settings for restricted accounts.

To change the settings, on the Applications screen, tap **Settings** → **GENERAL** → **Users** and tap  next to an account. Then, select or deselect applications and content to allow or restrict the account's access to them.

To delete the account, tap . To delete the restricted account, tap  → .

Transferring files

Move audio, video, image, or other types of files from the device to the computer, or vice versa.

Connecting with Samsung Kies

Samsung Kies is a computer application that manages media contents and personal information with Samsung devices. Download the latest Samsung Kies from the Samsung website.

- 1 Connect the device to the computer using the USB cable.
Samsung Kies launches on the computer automatically. If Samsung Kies does not launch, double-click the Samsung Kies icon on the computer.
- 2 Transfer files between your device and the computer.
Refer to the Samsung Kies help for more information.

Connecting with Windows Media Player

Ensure that Windows Media Player is installed on the computer.

- 1 Connect the device to the computer using the USB cable.
- 2 Open Windows Media Player and sync music files.

Connecting as a media device

- 1 Connect the device to the computer using the USB cable.
- 2 Open the notifications panel, and then tap **Connected as a media device** → **Media device (MTP)**.
Tap **Camera (PTP)** if your computer does not support Media Transfer Protocol (MTP) or not have any appropriate driver installed.
- 3 Transfer files between your device and the computer.

Securing the device

Prevent others from using or accessing personal data and information stored in the device by using the security features. The device requires an unlock code whenever unlocking it.

Setting a pattern

On the Applications screen, tap **Settings** → **DEVICE** → **Lock screen** → **Screen lock** → **Pattern**.

Draw a pattern by connecting four dots or more, and then draw the pattern again to verify it. Set a backup unlock PIN to unlock the screen when you forget the pattern.

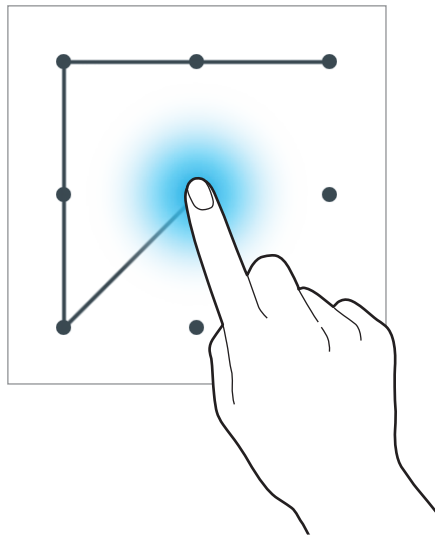

Setting a PIN

On the Applications screen, tap **Settings** → **DEVICE** → **Lock screen** → **Screen lock** → **PIN**. Enter at least four numbers, and then enter the password again to verify it.

Setting a password

On the Applications screen, tap **Settings** → **DEVICE** → **Lock screen** → **Screen lock** → **Password**.

Enter at least four characters including numbers and symbols, and then enter the password again to verify it.

Unlocking the device

Turn on the screen by pressing the Power button or the Home button, and enter the unlock code.



If the unlock code is forgotten, take the device to a Samsung Service Centre to reset it.

Upgrading the device

The device can be upgraded to the latest software.



This feature may not be available depending on the region or service provider.

Upgrading with Samsung Kies

Launch Samsung Kies and connect the device to the computer. Samsung Kies automatically recognises the device and shows available updates in a dialogue box, if any. Click the Update button in the dialogue box to start upgrading. Refer to the Samsung Kies help for details on how to upgrade.



- Do not turn off the computer or disconnect the USB cable while the device is upgrading.
- While upgrading the device, do not connect other media devices to the computer. Doing so may interfere with the update process.

Upgrading over the air

The device can be directly upgraded to the latest software by the firmware over-the-air (FOTA) service.

On the Applications screen, tap **Settings** → **GENERAL** → **About device** → **Software updates** → **Update now**.

Communication

Contacts

Use this application to manage contacts, including phone numbers, email addresses, and others.



Tap **Contacts** on the Applications screen.

Managing contacts

Tap **CONTACTS**.

Creating a contact

Tap  and enter contact information.

-  : Add an image.
-  /  : Add or delete a contact field.

Editing a contact

Select a contact to edit, and then tap .

Deleting a contact

Tap  → **Delete contacts**, select a contact, and then tap **DONE**.

Searching for contacts

Tap **CONTACTS**.

Use one of the following search methods:

- Scroll up or down the contacts list.
- Use the index at the left side of the contacts list for quick scrolling, by dragging a finger along it.
- Tap the search field at the top of the contacts list and enter search criteria.

Once a contact is selected, take one of the following actions:

- ★ : Add to favourite contacts.
- ✉ : Compose an email.

Displaying contacts

Tap **CONTACTS**.

By default, the device shows all saved contacts.

Tap  → **Settings** → **Contacts to display**, and then select a location where contacts are saved.

Moving contacts

Tap **CONTACTS**.

Moving contacts to Google

Tap  → **Move device contacts to** → **Google**.

Contacts moved to Google Contacts appear with  in the contacts list.

Moving contacts to Samsung

Tap  → **Move device contacts to** → **Samsung account**.

Contacts moved to Samsung Contacts appear with  in the contacts list.

Importing and exporting contacts

Tap **CONTACTS**.

Importing contacts

Tap  → **Settings** → **Import/Export contacts**, and then select an import option.

Exporting contacts

Tap  → **Settings** → **Import/Export contacts**, and then select an export option.

Sharing contacts

Tap  → **Select**, select contacts, tap , and then select a sharing method.

Favourite contacts

Tap **FAVOURITES**.

Tap  to add contacts to favourites.

Tap , and then take one of the following actions:

- **Remove from Favourites:** Remove contacts from favourites.
- **Help:** Access help information about using contacts.

Contact groups

Tap **GROUPS**.

Creating a group

Tap , set details for the group, add contacts, and then tap **SAVE**.

Adding contacts to a group

Select a group, and then tap  → **Add member**. Select contacts to add, and then tap **DONE**.

Managing groups

Tap , and then take one of the following actions:

- **Delete groups:** Select user-added groups, and then tap **DONE**. Default groups cannot be deleted.
- **Edit group:** Change the group settings.
- **Add member:** Add members to the group.
- **Remove from group:** Remove members from the group.
- **Send email:** Send an email to a group's members.
- **Change order:** Tap and hold  next to the group name, drag it up or down to another position, and then tap **DONE**.
- **Help:** Access help information about using contacts.

Sending an email to a group's members

Select a group, tap  → **Send email**, select members, and then tap **DONE**.

Business card

Tap **CONTACTS**.

Create a business card and send it to others.

Tap **Set up my profile**, enter details, such as phone number, email address, and postal address, and then tap **SAVE**. If user information has been saved when you set up the device, select the business card, and then tap  to edit.

Tap  → **Share name card via**, and then select a sharing method.

Email

Use this application to send or view email messages.

Tap **Email** on the Applications screen.



Setting up email accounts

Set up an email account when opening **Email** for the first time.

Enter the email address and password. Tap **NEXT** for a private email account, such as Google Mail, or tap **MANUAL SETUP** for a company email account. After that, follow the on-screen instructions to complete the setup.



To set up another email account, tap  → **Settings** → **Add account**.

Sending messages

Tap the email account to use, and then tap  at the top of the screen. Enter recipients, subject, and message, and then tap .

Tap  to add a recipient from the contacts list.

Tap  to attach images, videos, contacts, events, and others.

Tap  →  to insert images, events, contacts, location information, and others into the message.

Sending scheduled messages

While composing a message, tap  → **Schedule sending**. Tick **Schedule sending**, set a time and date, and then tap **DONE**. The device will send the message at the specified time and date.



- If the device is turned off at the scheduled time, is not connected to the network, or the network is unstable, the message will not be sent.
- This feature is based on the time and date set on the device. The time and date may be incorrect if you move across time zones and the network does not update the information.

Reading messages

Select an email account to use, and new messages are retrieved. To manually retrieve new messages, tap .

Tap a message to read.

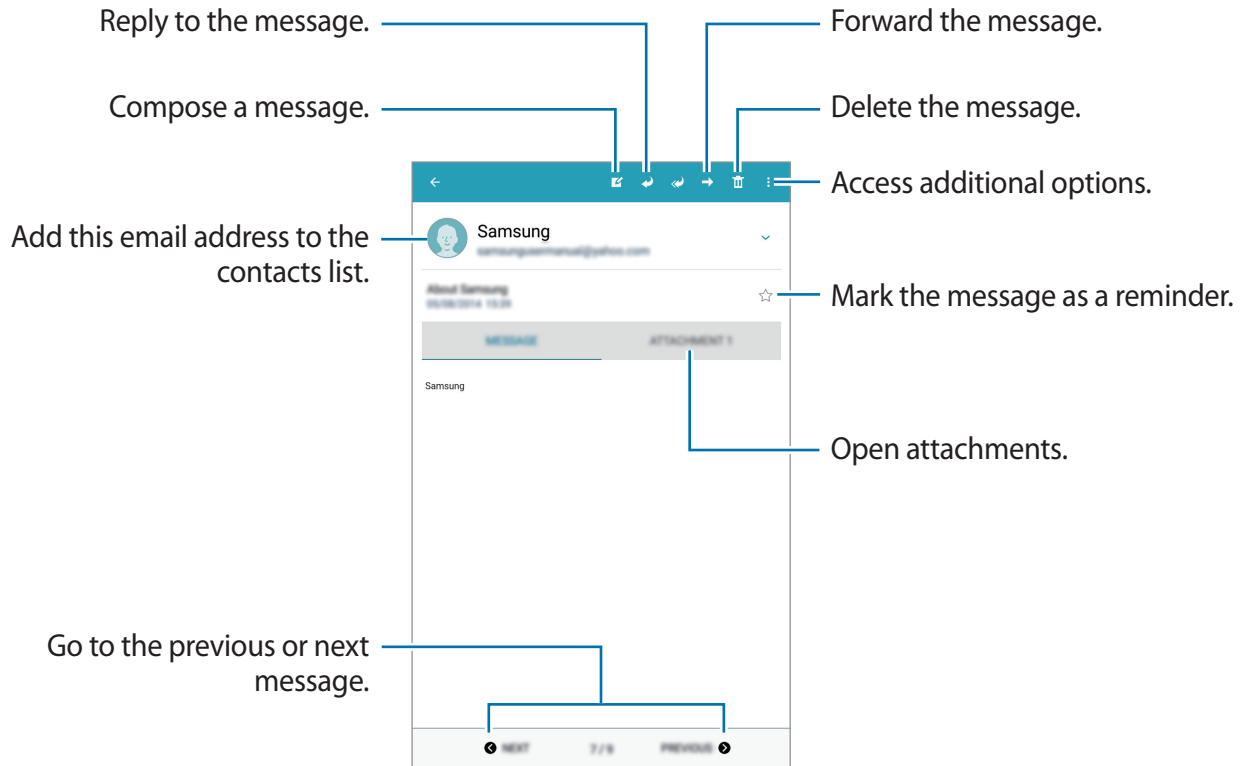

Tap the attachment tab to open attachments, and then tap **SAVE** to save it.

Gmail



Use this application to quickly and directly access the Google Mail service.

Tap **Gmail** on the Applications screen.



- This application may not be available depending on the region or service provider.
- This application may be labelled differently depending on the region or service provider.

Sending messages

In any mailbox, tap , enter recipients, a subject, and a message, and then tap .

Tap  to attach images, videos, music, and others.

Tap  → **Save draft** to save the message for later delivery.

Tap  → **Discard** to start over.

Tap  → **Settings** to change the Google Mail settings.

Tap  → **Help & feedback** to access help information for the Google Mail or report your opinions for application development.

Reading messages

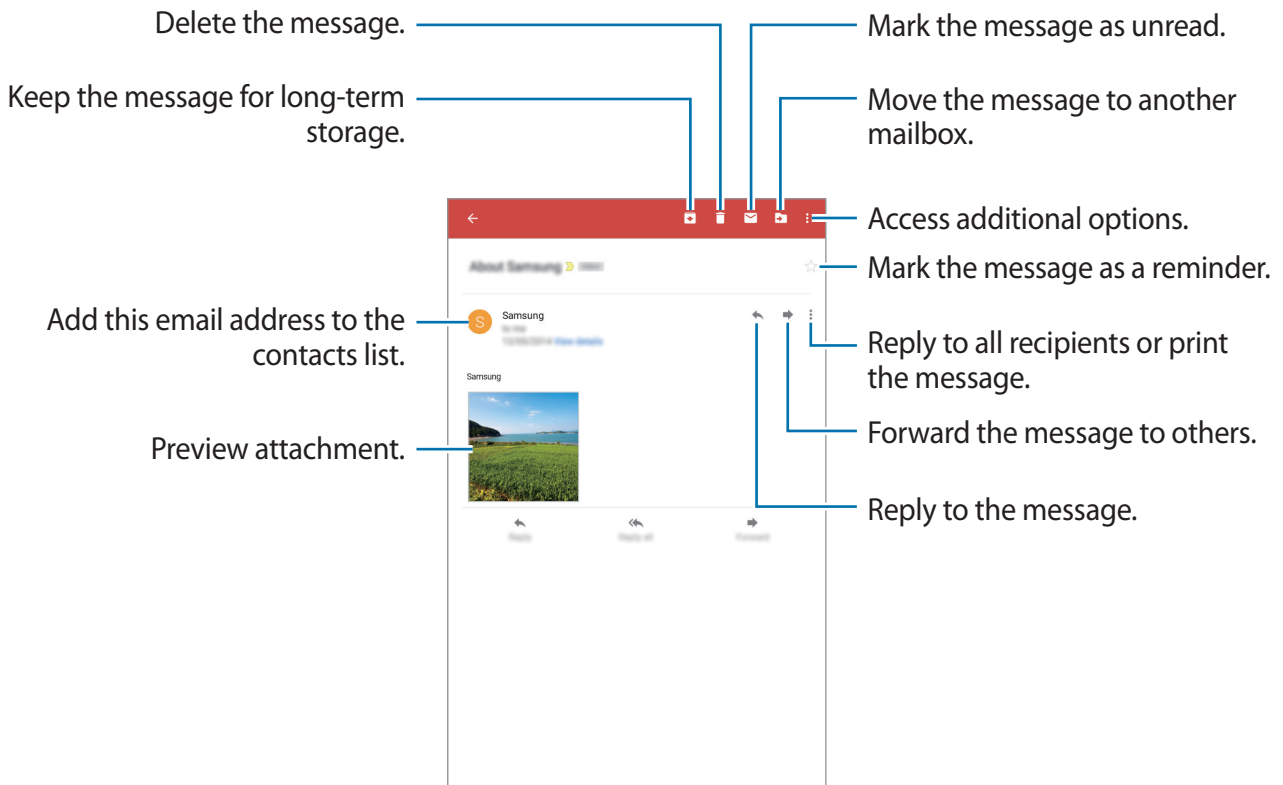

Labels

Google Mail does not use actual folders, but uses labels instead. When Google Mail is launched, it displays messages labelled Inbox.

Tap  to view messages in other labels.

To add a label to a message, select the message, tap  → **Change labels**, and then select the label to assign.

Hangouts

Use this application to chat with others.

Tap **Hangouts** on the Applications screen.



This application may not be available depending on the region or service provider.

Select a friend from the friends list or enter data to search and select a friend from the results to start chatting.

Google+

Use this application to stay connected with people via Google's social network service.

Tap **Google+** on the Applications screen.



This application may not be available depending on the region or service provider.

Tap **Home** to change the category, and then scroll up or down to view posts from your circles.

Photos

Use this application to view and share images or videos via Google's social network services. Tap **Photos** on the Applications screen.





This application may not be available depending on the region or service provider.

Select one of the following categories:

- **ALL:** View all the images or videos that are taken or downloaded to the device.
- **HIGHLIGHTS:** View images or videos grouped by date or album. Tap  to view all of the images or videos in the group.

Then, select an image or video.

While viewing it, use one of the following icons:

- : Modify the image.
- : Share the image or video with others.
- : Delete the image or video.

Web & network

Internet

Use this application to browse the Internet.

Tap **Internet** on the Applications screen.

Viewing webpages

Tap the address field, enter the web address, and then tap **Go**.



Tap  to access additional options while viewing a webpage.

Opening a new page

Tap .

To go to another webpage, scroll left or right on the title field, and then tap the title to select it.

Searching the web by voice

Tap the address field, tap   , and then speak a keyword.



This feature may not be available depending on the region or service provider.

Bookmarks

To bookmark the current webpage, tap   **ADD**.

To open a bookmarked webpage, tap , and then select one.

History

Tap  → **HISTORY** to open a webpage from the list of recently-visited webpages. To clear the history, tap **MORE** → **Clear history**.

Saved pages

To view saved webpages, tap  → **SAVED PAGES**.

Links

Tap and hold a link on the webpage to open it in a new page, save, or copy.

To view saved links, on the Applications screen, tap **My Files** → **Device storage** → **Download**.

Sharing webpages

To share a webpage address with others, tap  → **Share**.

To share a part of a webpage, tap and hold the desired text, and then tap **Share**.

Chrome

Use this application to search for information and browse webpages.

Tap **Chrome** on the Applications screen.



This application may not be available depending on the region or service provider.

Viewing webpages

Tap the address field, and then enter a web address or search criteria.

Opening a new page

Tap  → **New tab**.

To go to another webpage, scroll left or right on the title field, and tap the title to select it.

Bookmarks

To bookmark the current webpage, tap ☆ → **Save**.

To open a bookmarked webpage, tap ⋮ → **Bookmarks**, and then select one.

Searching the web by voice

Tap 🗣️, and then speak a keyword.

Syncing with other devices

Sync open tabs and bookmarks to use with Chrome on another device, when you are logged in with the same Google account.

To view open tabs on other devices, tap ⋮ → **Recent tabs**. Select a webpage to open.

Bluetooth

Bluetooth creates a direct wireless connection between two devices over short distances. Use Bluetooth to exchange data or media files with other devices.



- Samsung is not responsible for the loss, interception, or misuse of data sent or received via the Bluetooth feature.
- Always ensure that you share and receive data with devices that are trusted and properly secured. If there are obstacles between the devices, the operating distance may be reduced.
- Some devices, especially those that are not tested or approved by the Bluetooth SIG, may be incompatible with your device.
- Do not use the Bluetooth feature for illegal purposes (for example, pirating copies of files or illegally tapping communications for commercial purposes).
Samsung is not responsible for the repercussion of illegal use of the Bluetooth feature.

To activate Bluetooth, on the Applications screen, tap **Settings** → **CONNECTIONS** → **Bluetooth**, and then drag the **Bluetooth** switch to the right.

Pairing with other Bluetooth devices

On the Applications screen, tap **Settings** → **CONNECTIONS** → **Bluetooth** → **SCAN**, and detected devices are listed. Select the device you want to pair with, and then accept the auto-generated passkey on both devices to confirm.

Sending and receiving data

Many applications support data transfer via Bluetooth. An example is **Gallery**. Open **Gallery**, select an image, tap  → **Bluetooth**, and then select one of the Bluetooth devices. After that, accept the Bluetooth authorisation request on the other device to receive the image.

When another device sends you data, accept the Bluetooth authorisation request made by another device. Received files are saved in the **Download** folder. If a contact is received, it is added to the contacts list automatically.

Screen Mirroring

Use this feature to connect your device to a large screen with an AllShare Cast dongle or HomeSync and then share your contents.



- This feature may not be available depending on the region or service provider.
- Some files may be buffered during playback, depending on the network connection.
- To save energy, deactivate this feature when not in use.
- If you specify a Wi-Fi frequency, AllShare Cast dongles or HomeSync may not be discovered or connected.
- If you play videos or games on a TV, select an appropriate TV mode to get the best experience.

On the Applications screen, tap **Settings** → **CONNECTIONS** → **Screen Mirroring**. The detected devices are listed. Select a device, open or play a file, and then control the display with the keys on your device. To connect to a device using a PIN, tap and hold the device name to enter the PIN.

Media

Music

Use this application to listen to music.

Tap **Music** on the Applications screen.

Playing music

Select a music category, and then select a song to play.

Tap the album image at the bottom of the screen to open the music player screen.

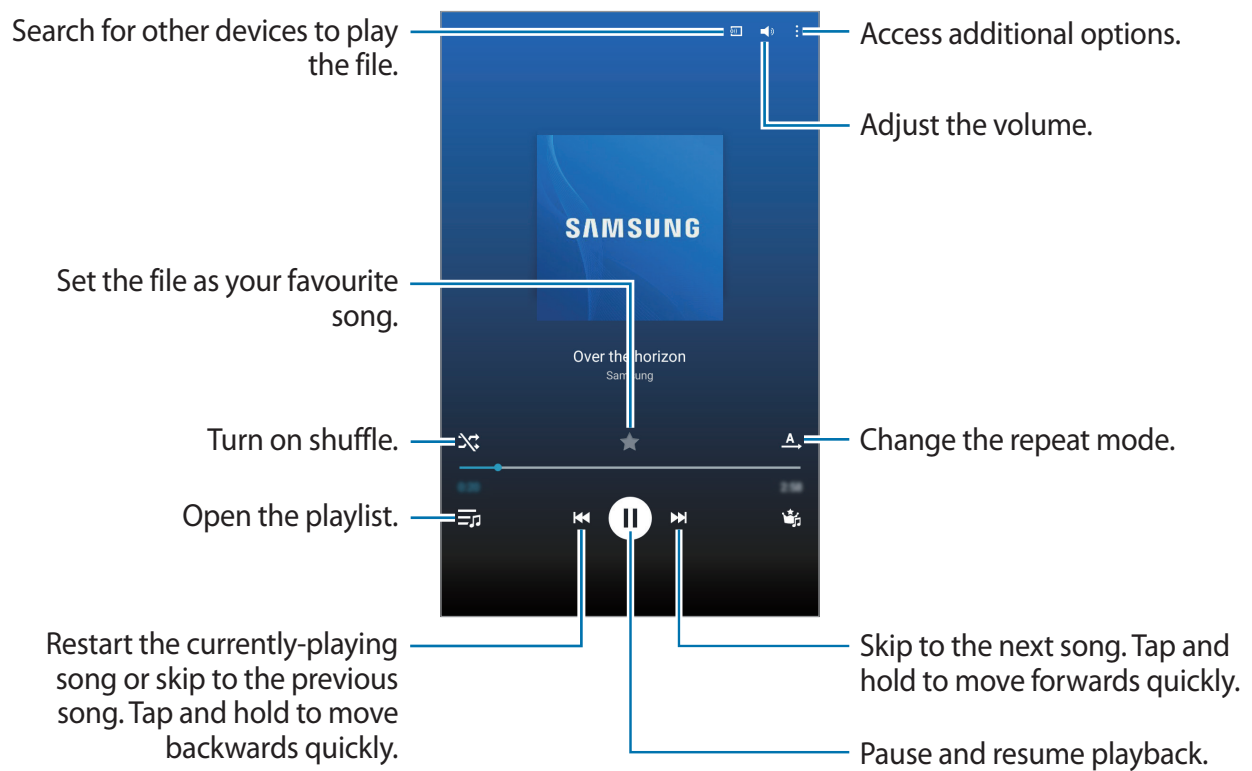

To listen to songs at equal volume levels, tap  → **Settings** → **Advanced** → **Smart volume**.



When **Smart volume** is activated, the volume may end up louder than the device volume level. Use caution to avoid long-term exposure to loud sounds to prevent damage to your hearing.



Smart volume may not be activated for some files.

To set a personalised sound while listening to songs with a headset, tap  → **Settings** → **Advanced** → **Adapt Sound** → **On**. When you turn the volume up to level 14 or higher, the adapt sound option is not applied to music playback. If you turn the volume down to level 13 or lower, the option is reapplied.

Setting a song as alarm ringtone

To use the currently-playing song as alarm ringtone, tap  → **Set as** → **DONE**.

Creating playlists

Make an own selection of songs.

Tap **PLAYLISTS**, and then tap  → **Create playlist**. Enter a title and tap **OK**. Tap , select songs to include, and then tap **DONE**.

To add the currently-playing song to a playlist, tap  → **Add to playlist**.

Playing music by mood

Play music grouped by mood. The playlist is automatically created by the device.

Tap **MUSIC SQUARE**, and select a cell of mood. Or select multiple cells by dragging your finger.

Camera

Use this application to take photos or videos.

Use **Gallery** to view photos and videos taken with the device's camera. (p. 62)

Tap **Camera** on the Applications screen.



- The camera automatically shuts off when unused.
- Make sure that the lens is clean. Otherwise, the device may not work properly in some modes that require high resolutions.

Camera etiquette

- Do not take photos or videos of other people without their permission.
- Do not take photos or videos where legally prohibited.
- Do not take photos or videos in places where you may violate other people's privacy.

Taking photos

Taking a photo

Tap  to take a photo.



Shooting mode

Several photo effects are available.

Tap **MODE**, and then scroll up or down the screen at the right side of the screen.

- **Auto:** Use this to allow the camera to evaluate the surroundings and determine the ideal mode for the photo.
- **Beauty face:** Take a photo with lightened faces for gentler images.
- **Sound & shot:** Use this to take a photo with sound.

Tap  to take a photo. The device records a few seconds of audio after taking a photo.



While taking photos in this mode, sound is recorded by the internal microphone.

- **Panorama:** Take a photo composed of many photos strung together.



To get the best shot, follow these tips.

- Move the camera slowly in one direction.
 - Keep the camera's viewfinder within the guide frame.
 - Avoid taking photos of a subject in front of unrecognisable backgrounds, such as empty skies or plain walls.
- **Sports:** Use this setting for fast-moving subjects.
 - **Night:** Use this setting for images taken in darker conditions.

Panoramic photos

A panoramic photo is a wide landscape image consisting of multiple shots.

Tap **MODE** → **Panorama**.

Tap  and move the camera in one direction. When two panorama guide frames are aligned, the camera automatically takes another shot in a panoramic sequence. To stop shooting, tap .

If the viewfinder is out of the direction, the device stops shooting.



Applying filter effects

Use the filter effects to take unique photos or videos.

Tap  and select a filter effect. The available options vary by mode.

Taking videos

Taking a video

Slide the still-video switch to the video icon, and then tap  to take a video. To pause recording, tap . To stop recording, tap .



- Manual focus is not available in video mode.
- The zoom function may not be available when recording at the highest resolution.

Recording mode



Tap → to change the recording mode.

- **Normal:** Use this mode for normal quality.
- **Limit for email:** Use this mode to lower the recording quality for sending via email.

Zooming in and out

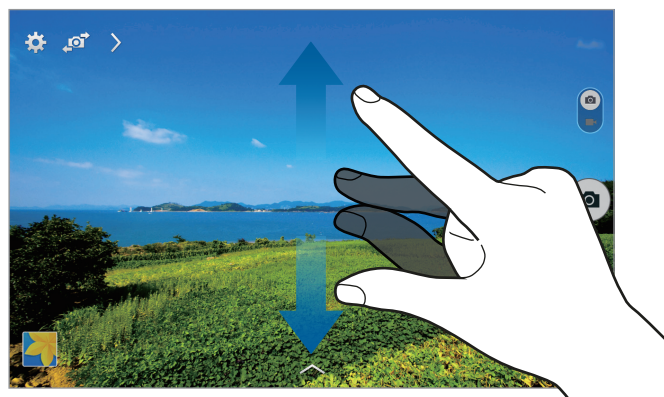

Use one of the following methods:

- Use the Volume button to zoom in or out.
- Spread two fingers apart on the screen to zoom in, and pinch to zoom out.



The zoom in/out effect is available when using the zoom feature while shooting video.



Share shot

Tap  →  and then select one of the following:

- **Share shot:** Send a photo directly to another device via Wi-Fi Direct.
- **Buddy photo share:** Set the device to recognise a person's face that you have tagged in a photo and send it to that person.
- **Remote viewfinder:** Set a device to control the camera remotely.

Controlling the camera remotely

Set a device as a viewfinder to control the camera remotely.

Tap  →  → **Remote viewfinder**, and then connect the device and the camera using Wi-Fi Direct. Tap  to take a photo remotely using the device as a viewfinder.

Configuring settings for Camera

Tap  to configure settings for Camera. Not all of the following options are available in both still camera and video camera modes. The available options vary depending on the mode used.

- **Photo size / Video size:** Select a resolution. Use higher resolution for higher quality. But it takes up more memory.
- **Metering modes:** Select a metering method. This determines how light values are calculated. **Centre-weighted** measures background light in the centre of the scene. **Spot** measures the light value at a specific location. **Matrix** averages the entire scene.
- **Location tag:** Attach a GPS location tag to the photo.



- To improve GPS signals, avoid shooting in locations where the signal may be obstructed, such as between buildings or in low-lying areas, or in poor weather conditions.
- Your location may appear on your photos when you upload them to the Internet. To avoid this, deactivate the GPS tag setting.

- **Review pics/videos:** Set the device to show photos or videos after taking them.
- **Volume key:** Set the device to use the Volume button to control the shutter or zoom function.
- **Timer:** Use this for delayed-time shots.
- **White balance:** Select an appropriate white balance, so images have a true-to-life colour range. The settings are designed for specific lighting situations. These settings are similar to the heat range for white-balance exposure in professional cameras.
- **Brightness:** Change the brightness.
- **Guidelines:** Display viewfinder guides to help composition when selecting subjects.
- **Voice control:** Set the camera to take photos with voice commands.
- **Contextual filename:** Set the camera to display contextual tags. Activate this to use Tag Buddy in **Gallery**.
- **Save as flipped:** Invert the image to create a mirror-image of the original scene.
- **Storage:** Select the memory location for storage.
- **Reset:** Reset the camera settings.
- **Help:** Access help information for using the camera.

Shortcuts

Reorganise shortcuts for easy access to the camera's various options.

Tap  and tap and hold a shortcut icon.

Tap and hold an option and drag it to a slot at the top of the screen.

Gallery

Use this application to view images and videos.

Tap **Gallery** on the Applications screen.

Viewing images

Launching **Gallery** displays available folders. When another application, such as **Email**, saves an image, the **Download** folder is automatically created to contain the image. Likewise, capturing a screenshot automatically creates the **Screenshots** folder. Select a folder to open it.

In a folder, images are displayed by creation date. Select an image to view it in full screen.

Scroll left or right to view the next or previous image.

Zooming in and out

Use one of the following methods to zoom in an image:

- Double-tap anywhere to zoom in.
- Spread two fingers apart on any place to zoom in. Pinch to zoom out, or double-tap to return.

Playing videos

Video files show the  icon on the preview. Select a video to watch it and tap .

Trimming segments of a video

Select a video and tap . Move the start bracket to the desired starting point, move the end bracket to the desired ending point, and then save the video.

Editing images

When viewing an image, tap  and use the following functions:



- **Favourite:** Add to the favourites list.
- **Slideshow:** Start a slideshow with the images in the current folder.
- **Photo frame:** Use this to add a frame and a note to an image. The edited image is saved in the **Photo frame** folder.
- **Write on image:** Use this to write a note on the back of the image. Tap  to edit the note.
- **Print:** Print the image by connecting the device to a printer. Some printers may not be compatible with the device.
- **Rename:** Rename the file.
- **Buddy photo share:** Send the image to a person whose face is tagged in the image.
- **Rotate left:** Rotate anticlockwise.
- **Rotate right:** Rotate clockwise.
- **Crop:** Resize the blue frame to crop and save the image in it.
- **Set as:** Set the image as wallpaper or a contact image.
- **Details:** View image details.
- **Settings:** Change the Gallery settings.

Favourite images

When viewing an image, tap  → **Favourite** to add the image to the favourites list.



Deleting images

Use one of the following methods:

- In a folder, tap  → **Select item**, select images, and then tap .
- When viewing an image, tap .

Sharing images

Use one of the following methods:

- In a folder, tap  → **Select item**, select images, and then tap  to send them to others or share them via social network services.
- When viewing an image, tap  to send it to others or share it via social network services.

Setting as wallpaper

When viewing an image, tap  → **Set as** to set the image as wallpaper or to assign it to a contact.

Tagging faces

When viewing an image, tap  → **Settings** → **Tags**, and then tick **Face tag**. A yellow frame appears around the recognised face. Tap the face, tap **Add name**, and then select or add a contact.

When the face tag appears on an image, tap the face tag and use available options, such as sending messages.



Face recognition may fail depending on the face angle, face size, skin colour, facial expression, light conditions, or accessories the subject is wearing.

Using Tag buddy

Tap  → **Settings** → **Tags** → **Tag buddy**, and then drag the **Tag buddy** switch to the right to display a contextual tag (weather, location, date, and person's name) when opening an image.

Organising with folders

Create a folder to organise images or videos stored in the device. You can copy or move files from one folder to another.

To create a new folder, tap . Enter a name for the folder, tap **OK**, and then tick images or videos. Tap and hold any selected image or video, drag it to the new folder, and then tap **DONE**. Tap **COPY** to copy or **MOVE** to move.

Video

Use this application to play video files.

Tap **Video** on the Applications screen.

Playing videos

Select a video to play.

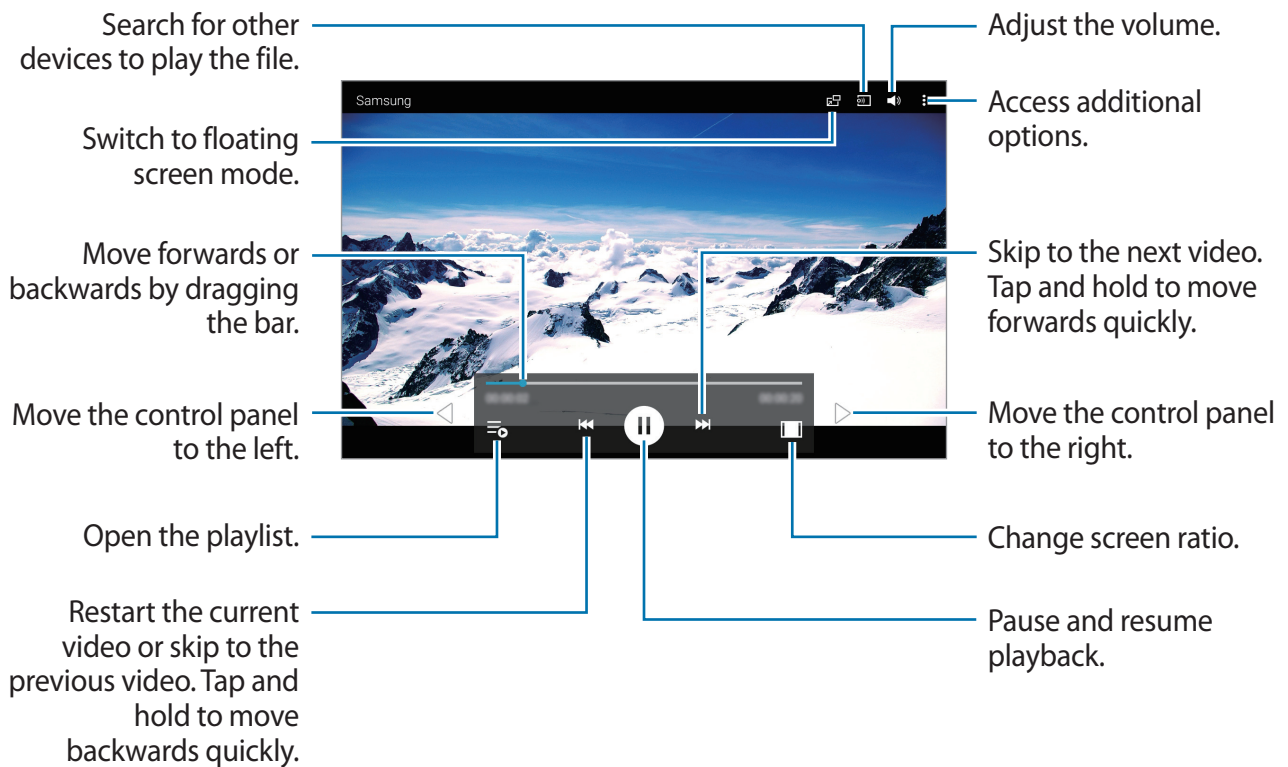

Deleting videos

Tap **⋮** → **Delete**, select videos, and then tap **DONE**.

Sharing videos

Tap  → **Select**, select videos, tap , and then select a sharing method.

Using Popup Video player

Use this feature to use other applications without closing the video player. While watching videos, tap  to use the pop-up player.

Spread two fingers apart on the screen to enlarge the player or pinch to reduce it. To move the player, drag the player to another location.

YouTube

Use this application to watch videos from the YouTube website.

Tap **YouTube** on the Applications screen.



This application may not be available depending on the region or service provider.

Watching videos



Tap , and then enter a keyword. Select one of the returned search results to watch a video.

Tap the screen, tap , and then rotate the device to landscape orientation to display full screen.

Sharing videos

Select the video to view, tap , and then select a sharing method.

Uploading videos

Tap  → **Uploads** → , select a video, enter information for the video, and then tap **UPLOAD**.

Application & media stores

Play Store

Use this application to purchase and download applications and games that are able to run on the device.

Tap **Play Store** on the Applications screen.



This application may not be available depending on the region or service provider.

Installing applications

Browse applications by category, or tap  to search with a keyword.

Select an application to view information. To download it, tap **INSTALL**. If there is a charge for the application, tap the price, and follow the on-screen instructions to complete the purchase process.



When a new version is available for any installed application, an update icon appears at the top of the screen to alert you to the update. Open the notifications panel and tap the icon to update the application.

Uninstalling applications

Uninstall the applications purchased from **Play Store**.

Tap  → **My apps**, select an application to delete in the list of installed applications, and then tap **UNINSTALL**.

Galaxy Apps

Use this application to purchase and download dedicated Samsung applications. For more information, visit apps.samsung.com.

Tap **Galaxy Apps** on the Applications screen.



This application may not be available depending on the region or service provider.

Installing applications

Browse applications by category. Tap **CATEGORY** to select a category.

To search for an application, tap **SEARCH** at the top of the screen, and then enter a keyword in the search field.

Select an application to view information. To download it, tap **INSTALL**. If there is a charge for the application, tap the price, and follow the on-screen instructions to complete the purchase process.



When a new version is available for any installed application, an update icon appears at the top of the screen to alert you to the update. Open the notifications panel and tap the icon to update the application.

Play Books

Use this application to read and download book files.

Tap **Play Books** on the Applications screen.



This application may not be available depending on the region or service provider.

Play Movies & TV

Use this application to watch, download, and rent movies or TV shows.

Tap **Play Movies & TV** on the Applications screen.



This application may not be available depending on the region or service provider.

Play Music

Use this application to listen to music from the device or stream music from the Google cloud service.

Tap **Play Music** on the Applications screen.



This application may not be available depending on the region or service provider.

Play Games

Use this application to download and play games.

Tap **Play Games** on the Applications screen.



This application may not be available depending on the region or service provider.

Play Newsstand

Use this application to read the latest news articles.

Tap **Play Newsstand** on the Applications screen.



This application may not be available depending on the region or service provider.

Utilities

Memo

Use this application to record important information to save and view at a later date.

Tap **Memo** on the Applications screen.



Adding and managing categories

Create categories to sort and manage your memos.

To add a new category, tap  → **MANAGE CATEGORIES** → **ADD**, enter a category name, and then tap **OK**.



To delete a category, tap  → **MANAGE CATEGORIES**, and then tap  next to the category.

To rename a category, select a category, tap  → **Rename category**, enter a new name for the category, and then tap **RENAME**.

To change the category order, tap  → **MANAGE CATEGORIES**, and then tap  next to a category and drag it up or down to another position.

Composing memos

Tap  on the memos list and enter a memo. While composing a memo, use the following options:

-  : Create or set a category.
-  : Insert images.
-  : Make a voice recording to insert.

To save the memo, tap **SAVE**.



To edit a memo, tap a memo, and then tap the content of the memo.

Browsing memos

Browse memo thumbnails by scrolling up or down.

To search for a memo, tap .

To send a memo to others, tap  → **Select**, select a memo, and then tap .

To print memos by connecting the device to a printer, tap  → **Select**, select memos, and then tap . Some printers may not be compatible with the device.

To delete memos, tap  → **Select**, select memos, and then tap .

Viewing a memo

Tap a memo thumbnail to open it.

To delete the memo, tap .

To send the memo to others, tap .

To print the memo by connecting the device to a printer, tap . Some printers may not be compatible with the device.

S Planner

Use this application to manage events and tasks.

Tap **S Planner** on the Applications screen.

Creating events or tasks

Tap , and then use one of the following methods:

- **EVENT**: Enter an event with an optional repeat setting.
- **TASK**: Enter a task with an optional priority setting.

To add an event or task more briefly, tap a date to select it and tap it again.

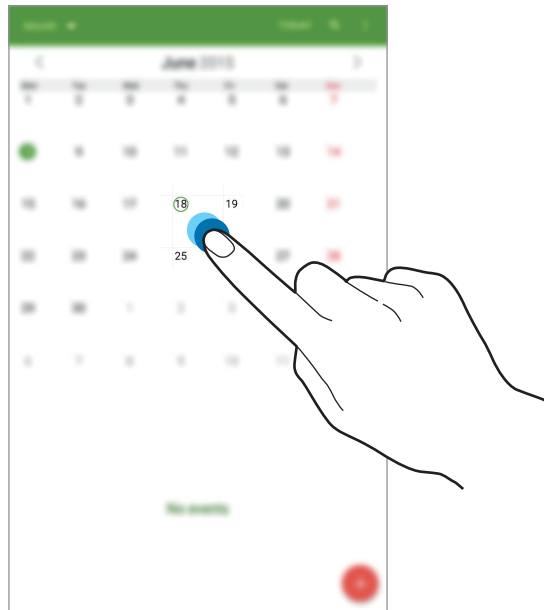

Enter a title and specify which calendar to use or sync with. Then tap **VIEW MORE OPTIONS** to add more details, such as how often the event repeats, when it has an advance alert, or where it takes place.

Attach a map showing the location of the event. Enter the location in the **Location** field, tap  next to the field, and then pinpoint the precise location by tapping and holding on the map that appears.

Syncing with Google Calendar

On the Applications screen, tap **Settings** → **GENERAL** → **Accounts** → **Google** under **My accounts**, select the Google account, and then tick **Sync Calendar**.

To manually sync for updating, on the Applications screen, tap **S Planner** →  → **Sync now**.

To display synced events or tasks, tap  → **Calendars**, and then tick the Google account.

Changing calendar type

Tap the top left of the screen, and then select one from among different types of calendars including year, month, week, and others.

Searching for events or tasks

Tap , and then enter a keyword to search for.

To view today's events or tasks, tap **TODAY** at the top of the screen.

Deleting events or tasks

Select an event or task, and then tap  → **Delete**.

Sharing events or tasks

Select an event or task, tap  → **Share via**, and then select a sharing method.

Dropbox



Use this application to save and share files with others via the Dropbox cloud storage. When you save files to Dropbox, your device automatically syncs with the web server and any other computers that have Dropbox installed.

Tap **Dropbox** on the Applications screen.





This application may not be available depending on the region or service provider.

Sign in to your Dropbox account. If you do not have it, create a Dropbox account.

Once Dropbox is activated, tap **Turn on Camera Upload** to upload photos and videos taken with the device's camera to Dropbox automatically. To view the uploaded photos or videos, tap . To share or delete files or create albums, tap , and then select files.

To upload files to Dropbox, tap  →  → **Upload here** → **Photos or videos** or **Other files**. To open files in Dropbox, select a file.

While viewing images or videos, tap  to add it to the favourites list. To open files in the favourites list, tap .

Cloud

Use this feature to sync files or back up application data with your Samsung account or Dropbox.

On the Applications screen, tap **Settings** → **GENERAL** → **Cloud**.



This feature may not be available depending on the region or service provider.

Syncing with the Samsung account

Tap your Samsung account or **Sync settings** to sync files.

Backing up or restoring data

Tap **Backup** or **Restore** to back up or restore data with your Samsung account.

Syncing with Dropbox

Tap **Link Dropbox account**, and then enter the Dropbox account. Follow the on-screen instructions to complete the setup.

Once you sign in, tap **Allow** and the device automatically syncs files with Dropbox whenever you make some changes.

Drive

Use this application to create and edit documents and share them with others via Google Drive storage. When you create documents or upload files to Google Drive, your device automatically syncs with the web server and any other computer with Google Drive installed. Access your files without transferring or downloading.

Tap **Drive** on the Applications screen.



This application may not be available depending on the region or service provider.

Hancom Office Viewer

Use this application to view documents in various formats, including spreadsheets and presentations.

Tap **Hancom Office Viewer** on the Applications screen.







This application may not be available depending on the region or service provider.

Searching documents

Tap **Open** to browse a document.

While browsing a document, use one of the following options:

-  : Create a folder.
-  : Retrieve new documents.
-  : Sort documents and folders.
-  : Change the view mode.
-  : Select documents or folders.

To search for recently-used documents, tap **Recent Documents**.

Reading documents

Tap a document in **Recent Documents** or in a folder.

Tap  or , and then use one of the following functions:

Word processor

- **Find:** Search for text.
- **Zoom:** Change the view size.
- **Document Info:** View document details such as title, date, and author.
- **Print:** Print the document by connecting the device to a printer. Some printers may not be compatible with the device.
- **Send:** Send the document to others or share it.
- **About:** View information about Hancom Viewer.

Presentation

- **Find:** Search for text.
- **Zoom:** Change the view size.
- **Document Info:** View document details such as title, date, and author.
- **Slide Show:** Start a slideshow from the first page.
- **From Current Slide:** Start a slideshow from the current page.
- **Show Presenter View:** Display presentation tools on the device when it is connected to an external monitor.
- **Print:** Print the document by connecting the device to a printer. Some printers may not be compatible with the device.
- **Send:** Send the document to others or share it.
- **Edit:** Edit the document. To use this feature, you need to download and install the required application.
- **About:** View information about Hancom Viewer.

Spreadsheet

- **Find:** Search for text.
- **Zoom:** Change the view size.
- **Document Info:** View document details such as title, date, and author.
- **Sort:** Sort cells by specific criteria.
- **Show Formulas:** View the formulas inside cells instead of their calculated results.
- **Freeze Panes:** Keep the selected row in place.
- **Gridlines:** Hide or show gridlines.
- **Show All Comments:** Hide or show memos on the document.
- **Print Area:** Select an area to print.
- **Print:** Print the document by connecting the device to a printer. Some printers may not be compatible with the device.
- **Send:** Send the document to others or share it.
- **Edit:** Edit the document. To use this feature, you need to download and install the required application.
- **About:** View information about Hancom Viewer.

PDF

- **Search:** Search for text.
- **Send:** Send the document to others or share it.
- **Properties:** View document details such as title, date, and author.
- **Zoom:** Change the view size.
- **Hide comments:** Hide or show comments on the document.
- **Vertical page scrolling / Continuous view / Horizontal page scrolling:** Change the view mode.
- **Reading view:** View the document contents only, without margins.
- **Go to page:** Move to a specified page.
- **Bookmarks:** View bookmarks on the document.
- **Print:** Print the document by connecting the device to a printer. Some printers may not be compatible with the device.

Alarm

Use this application to set alarms for important events.

Tap **Alarm** on the Applications screen.

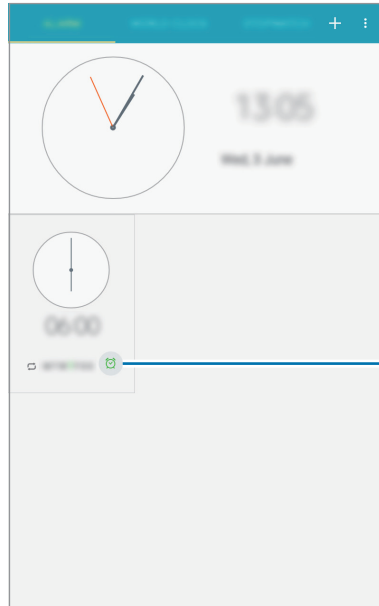



Turn this alarm on or off.

Setting alarms



Tap **+**, set a time for the alarm to go off, select days for the alarm to repeat, and then tap **SAVE**.

- **Snooze:** Set an interval and the number of times for the alarm to repeat after the preset time.
- **Smart alarm:** Set a time for the alarm to go off before the preset time.

Stopping alarms

Drag  outside the large circle to stop an alarm. Drag  outside the large circle to repeat the alarm after a specified length of time.

Deleting alarms

Tap  → **Delete**, select alarms, and then tap .

World clock

Use this application to check the time of many major cities in the world.

Tap **World clock** on the Applications screen.

Creating clocks

Tap  and enter a city name or select a city from the cities list.

To apply summer time, tap  → **Select**, select a clock, and then tap .

Deleting clocks

Tap  → **Select**, select clocks, and then tap .

Calculator

Use this application for simple or complex calculations.

Tap **Calculator** on the Applications screen.

You can see the calculation history at the upper part of the screen.

To clear the history, tap **CLEAR HISTORY**.

S Voice

Use this application to command the device by voice to perform various features.

Tap **S Voice** on the Applications screen. Alternatively, press the Home button twice.



- This application may not be available depending on the region or service provider.
- This application is not supported in some languages.

Here are several examples of spoken commands:

- Open music
- Launch calculator
- Check schedule

Tips for better voice recognition

- Speak clearly.
- Speak in quiet places.
- Do not use offensive or slang words.
- Avoid speaking in dialectal accents.

The device may not recognise your commands or may perform unwanted commands depending on your surroundings or how you speak.

Google

Use this application to search not only the Internet, but also applications and their contents on the device as well.

Tap **Google** on the Applications screen.



This application may not be available depending on the region or service provider.

Searching the device

Tap the search field, and then enter a keyword. Alternatively, tap , and then speak a keyword.

Google Now

Launch Google search to view Google Now cards that show the current weather, public transit info, your next appointment, and more when you are most likely to need it.

Join Google Now when opening Google search for the first time. To change Google Now settings, tap  → **Settings** → **Now cards**, and then tap the **Show cards** switch to activate it.

Voice Search

Use this application to search webpages by speaking.

Tap **Voice Search** on the Applications screen.



This application may not be available depending on the region or service provider.

Speak a keyword or phrase when **Listening...** appears on the screen.

My Files

Use this application to access all kinds of files stored in the device, including images, videos, songs, and sound clips.

Tap **My Files** on the Applications screen.

Viewing files

Files stored in the device are sorted by criteria. From the left pane of the screen, select one of the following categories:





- **Timeline:** View files that are grouped by date.
- **Favourite folders:** View shortcuts to folders.
- **Folders:** View files stored in the internal memory or a memory card, and shortcuts to FTP servers.
- **Categories:** View files sorted by their types.
- **Apps:** View files stored or created in specific applications.





Select a category, and then select a file or folder to open it.

After selecting a category, tap , and then use one of the following options:

- **Select:** Select files or folders.
- **Sort by:** Sort files or folders.
- **Add to favourite folders:** Add a shortcut to the folder in **Favourite folders**.
- **Add shortcut to home:** Add a shortcut to a file or folder to the Home screen.
- **Add FTP:** Add an FTP server shortcut in **Folders**.
- **Scan for nearby devices:** Search for devices that have media sharing activated.
- **Display options:** Change the file display options.

Tap  → **Select**, select a file or folder, and then use one of the following functions:

- : Send files to others or share them.
- : Delete files or folders.
- : Move files or folders to another folder.
- : Copy files or folders to another folder.

-  → **Rename**: Rename a file or folder.
-  → **Add to favourite folders**: Add a shortcut to the folder in **Favourite folders**.
-  → **Add shortcut to home**: Add a shortcut to a file or folder to the Home screen.
-  → **Zip**: Compress files or folders to create a zip file.
-  → **Details**: View file or folder details.

Creating folders

Tap , enter a name for the folder, and then tap **CREATE**.

Changing the view mode

Tap  to change the view mode.

Viewing storage information

Tap  to view memory information for your device and memory card.

Searching for a file

Tap , and then enter search criteria.

Adding shortcuts to folders

Add a shortcut to frequently-used folders in **Favourite folders**. Select a folder and tap  → **Add to favourite folders**.

Adding FTP server shortcuts to the device

Add an FTP server shortcut in **Folders**. Tap  → **Add FTP**, enter details for the FTP server, and then tap **DONE**.

Travel & local

Maps

Use this application to pinpoint the location of the device, search for places, or get directions. Tap **Maps** on the Applications screen.



This application may not be available depending on the region or service provider.

Searching for locations

Search for locations by entering an address or a keyword. Once the location is found, select a location to view the detailed information. Refer to the help for more information.

Getting directions for a destination

Tap  to set starting and ending locations, and then select a travel method. The device shows the routes to get to the destination.

Settings

About Settings

Use this application to configure the device, set application options, and add accounts. Tap **Settings** on the Applications screen.

CONNECTIONS

Wi-Fi

Activate the Wi-Fi feature to connect to a Wi-Fi network and access the Internet or other network devices.

To use options, tap .

- **Advanced:** Customise Wi-Fi settings.
- **WPS push button:** Connect to a secured Wi-Fi network with a WPS button.
- **WPS PIN entry:** Connect to a secured Wi-Fi network with a WPS PIN.
- **Help:** Access help information for Wi-Fi.

Setting Wi-Fi sleep policy

On the Settings screen, tap **CONNECTIONS** → **Wi-Fi** →  → **Advanced** → **Keep Wi-Fi on during sleep**.

Setting Network notification

The device can detect open Wi-Fi networks and display an icon on the status bar to notify when available.

On the Settings screen, tap **CONNECTIONS** → **Wi-Fi** →  → **Advanced** and tick **Network notification** to activate this feature.

Wi-Fi Direct

Wi-Fi Direct connects two devices directly via a Wi-Fi network without requiring an access point.

On the Settings screen, tap **CONNECTIONS** → **Wi-Fi** →  → **Wi-Fi Direct**.

Bluetooth

Activate the Bluetooth feature to exchange information over short distances.

To use more options, tap .

- **Visibility timeout:** Set duration that the device is visible.
- **Received files:** View received files via the Bluetooth feature.
- **Rename device:** Change the device name.
- **Help:** Access help information for Bluetooth.

Flight mode

This disables all wireless functions on your device. You can use only non-network services.

Data usage

Keep track of your data usage amount.

To use more options, tap .

- **Mobile hotspots:** Select mobile hotspots to prevent applications that are running in the background from using them.

Location

Change settings for location information permissions.

- **Mode:** Select a method to collect your location data.
- **Recent location requests:** View which applications request your current location information and their battery usage.
- **Location services:** View the location services your device is using.
- **My places:** Set up profiles that will be used for specific locations when you use GPS, Wi-Fi, or Bluetooth features to find your current location.

More networks

Customise settings to control connections with other devices or networks.

Printing

Configure settings for printer plug-ins installed on the device. You can search for available printers or add one manually to print files via Wi-Fi or cloud services.

VPN

Set up and connect to virtual private networks (VPNs).

Nearby devices

- **Device name:** View the device name.
- **Content to share:** Set the device to share your content with other devices.
- **Allowed devices:** View the list of devices that can access your device.
- **Denied devices:** View the list of devices that are blocked from accessing your device.
- **Download to:** Select a memory location for saving media files.
- **Receive files from other devices:** Set the device to accept uploads from other devices.

Screen Mirroring

Activate the screen mirroring feature and share your display with others.

DEVICE

Sounds and notifications

Change settings for various sounds on the device.

- **Notification ringtone:** Select a ringtone for events, such as incoming messages.
- **App notifications:** Change the notification settings for each application.
- **Adapt Sound:** Personalise the sound for the ear you use most while listening to music.

Display

Change the settings for the display.

- **Brightness:** Set the brightness of the display.
- **Screen timeout:** Set the length of time the device waits before turning off the display's backlight.
- **Daydream:** Set the device to launch a screensaver when your device is connected to a desktop dock or charging.
- **Auto rotate screen:** Set the interface to rotate automatically when you rotate the device.
- **Display battery percentage:** Set the device to display the remaining battery life.

Multi window

Activate the Multi Window feature to run multiple applications on the screen at the same time.

- **Open in multi window view:** Set the device to activate the Multi Window feature when you open files from **My Files** or **Video**.

Lock screen

Change settings for the locked screen.

- **Screen lock:** Activate the screen lock feature. The following options may vary depending on the screen lock feature selected.
- **Clock widget options:** Configure settings for the clock widget.
 - **Clock size:** Change the size of the clock.
 - **Show date:** Set the device to show the date with the clock.
- **Personal message:** Edit the personal message.
- **Owner information:** Enter your information that is shown with the clock.
- **Unlock effect:** Select an effect when you unlock the screen.
- **Help text:** Set the device to show the help text on the locked screen.

Wallpaper

Change the wallpaper settings.

- **Home screen:** Select a background image for the Home screen.
- **Lock screen:** Select a background image for the locked screen.
- **Home and lock screen:** Select a background image for the Home screen and the locked screen.

Font

Change the settings for the font.

- **Font style:** Change the font type for display text.
- **Font size:** Change the font size.

Notification panel

Customise the items that appear on the notifications panel.

- **Brightness adjustment:** Set the device to display the brightness adjustment bar on the notifications panel.
- **Recommended apps:** Set the device to display a list of recommended applications on the notifications panel based on your actions, such as connecting a headset to the device.
- **Set quick setting buttons:** Rearrange the quick setting buttons displayed on the notifications panel.

Accessibility

Accessibility services are special features for those with certain physical disabilities. Access and alert the following settings to improve accessibility to the device.

- **Vision:** Customise the settings to improve accessibility for visually impaired users.
 - **TalkBack:** Activate TalkBack, which provides voice feedback.
 - **Speak passwords:** Set the device to read aloud passwords you enter with TalkBack.
 - **Font size:** Change the font size.
 - **Magnification gestures:** Set the device to zoom in and out with finger gestures.
 - **Notification reminder:** Set the device to alert you when you have missed notifications and set an interval for repeating the alert.
 - **Negative colours:** Reverse the display colours to improve visibility.
 - **Colour adjustment:** Adjust the colour scheme for the screen when the device determines that you are colour blind or having difficulty reading content.
 - **Accessibility shortcut:** Set the device to activate TalkBack when you press and hold the Power button, and then tap and hold the screen with two fingers.
 - **Text-to-speech options:** Change the settings for text-to-speech features used when TalkBack is activated, such as languages, speed, and more.

- **Hearing:** Customise the settings to improve accessibility for users with hearing impairment.
 - **Turn off all sounds:** Mute all device sounds.
 - **Samsung subtitles (CC):** Set the device to display closed captions on content supported by Samsung and to change the closed caption settings.
 - **Google subtitles (CC):** Set the device to display closed captions on content supported by Google and to change the closed caption settings.
 - **Sound balance:** Adjust the sound balance when using a dual headset.
 - **Mono audio:** Enable mono sound when listening to audio with one earbud.
- **Dexterity and interaction:** Customise the settings to improve accessibility for users who have reduced dexterity.
 - **Assistant menu:** Set the device to show the assistive shortcut icon that helps you access functions supported by external buttons or features on the notifications panel. You can also edit the menu on the shortcut icon.
 - **Tap and hold delay:** Set the recognition time for tapping and holding the screen.
 - **Interaction control:** Activate interaction control mode to restrict the reaction of the device for inputs in an application.
- **Single tap mode:** Set the device to control notifications by tapping the button instead of dragging it.
- **Manage accessibility:** Export or import the accessibility settings to share them with other devices.

CONTROLS

Language and input

Change the settings for text input. Some options may not be available depending on the selected language.

Language

Select a display language for all menus and applications.

Default

Select a default keyboard type for text input.

Samsung keyboard



The available options may vary depending on the region or service provider.

- **Select input languages:** Select languages for text input.
- **Predictive text:** Activate predictive text mode to predict words based on your input and show word suggestions. You can also customise the word prediction settings.
- **Auto replace:** Set the device to correct misspelled and incomplete words by tapping the space bar or punctuation mark.
- **Auto capitalise:** Set the device to automatically capitalise the first character after a final punctuation mark, such as a full stop, question mark, or exclamation mark.
- **Auto spacing:** Set the device to automatically insert a space between words.
- **Auto punctuate:** Set the device to insert a full stop when you double-tap the space bar.
- **Keyboard swipe:** Change the settings for the keyboard swipe feature.
- **Sound:** Set the device to sound when a key is touched.
- **Character preview:** Set the device to display a large image of each character tapped.
- **Reset settings:** Reset Samsung keyboard settings.

Google voice typing

- **Language:** Select input languages for text input.
- **Offline speech recognition:** Download and install language data for offline voice input.
- **Block offensive words:** Set the device to prevent the device from recognising offensive words in voice inputs.

Voice input

Select a default voice input service. You can also change settings for each service.

Text-to-speech options

- **Preferred TTS engine:** Select a speech synthesis engine. To change the settings for speech synthesis engines, tap .
- **Speech rate:** Select a speed for the text-to-speech feature.
- **Listen to an example:** Listen to the spoken text for an example.
- **Default language status:** View the status of the default language for the text-to-speech feature.

Pointer speed

Adjust the pointer speed for the mouse or trackpad connected to your device.

Palm motion

Activate the palm motion feature to control the device by touching the screen.

- **Capture screen:** Set the device to capture an image of the screen when you sweep your hand to the left or right across the screen.
- **Mute/pause:** Set the device to pause media playback when you touch the screen with your palm.

Smart screen

- **Smart stay:** Set the device to prevent the display backlight from turning off while you are looking at the display.

GENERAL

Accounts

Add email or SNS accounts.

Cloud

Change settings for syncing data or files with your Samsung account or Dropbox cloud storage.

Backup and reset

Change the settings for managing settings and data.

- **Back up my data:** Set the device to back up settings and application data to the Google server.
- **Backup account:** Set up or edit your Google backup account.
- **Automatic restore:** Set the device to restore settings and application data when the applications are reinstalled on the device.
- **Factory data reset:** Reset settings to the factory default values and delete all data.

Date and time

Access and alter the following settings to control how the device displays the time and date.



If the battery remains fully discharged or removed from the device, the time and date is reset.

- **Automatic date and time:** Automatically update the time and date when moving across time zones.
- **Set date:** Set the current date manually.
- **Set time:** Set the current time manually.
- **Select time zone:** Set the home time zone.
- **Use 24-hour format:** Display time in 24-hour format.

Accessories

Change the accessory settings.

- **Dock sound:** Set the device to play a sound when your device is connected to or removed from a desktop dock.
- **Audio output mode:** Set the device to use the dock speaker when your device is connected to a desktop dock.
- **Automatic unlock:** Set the device to unlock automatically when the cover is flipped open.

Application manager

View and manage the applications on your device.

Default applications

Select a default setting for using applications.

Users

Set up and manage user profiles for personalised settings.

Battery

View the amount of battery power consumed by your device.

- **Display battery percentage:** Set the device to display the remaining battery life.

Power saving mode

Activate power-saving mode and change the settings for power-saving mode.

- **CPU performance:** Set the device to limit some system resource usage.
- **Screen output:** Set the device to decrease the brightness of the display.
- **Learn about Power saving:** Discover how to reduce battery consumption.

Storage

View memory information for your device and memory card, or format a memory card.



Formatting a memory card permanently deletes all data from it.



The actual available capacity of the internal memory is less than the specified capacity because the operating system and default applications occupy part of the memory. The available capacity may change when you upgrade the device.

Security

Change settings for securing the device.

- **Device administrators:** View device administrators installed on the device. You can allow device administrators to apply new policies to the device.
- **Unknown sources:** Set the device to allow the installation of applications from unknown sources.
- **Encrypt device:** Set a password to encrypt data saved on the device. You must enter the password each time you turn on the device.



Charge the battery before enabling this setting because it may take more than an hour to encrypt your data.

- **Encrypt external SD card:** Set the device to encrypt files on a memory card.



If you reset your device to the factory defaults with this setting enabled, the device will not be able to read your encrypted files. Disable this setting before resetting the device.

- **Remote controls:** Set the device to allow control of your lost or stolen device remotely via the Internet. To use this feature, you must sign in to your Samsung account.
 - **Account registration:** Add or view your Samsung account.
 - **Google location service:** Set the device to allow location data collection or to determine the location of your lost or stolen device via Wi-Fi.
- **Go to website:** Access the Find my mobile website (*findmymobile.samsung.com*). You can track and control your lost or stolen device on the Find my mobile website.

- **Make passwords visible:** Set the device to display passwords as they are entered.
- **Security policy updates:**
 - **Automatic updates:** Set the device to check and download security updates automatically.
 - **Check for updates:** Check for security updates.
- **Send security reports:** Set the device to send security reports automatically when the device is connected to a Wi-Fi network.
- **Storage type:** Set a storage type for credential files.
- **Trusted credentials:** Use certificates and credentials to ensure secure use of various applications.
- **Install from device storage:** Install encrypted certificates stored on the USB storage.
- **Clear credentials:** Erase the credential contents from the device and reset the password.

About device

Access device information, edit the device name, or update device software.

Google Settings

Use this application to configure settings for some features provided by Google.

Tap **Google Settings** on the Applications screen.

Troubleshooting

Before contacting a Samsung Service Centre, please attempt the following solutions. Some situations may not apply to your device.

When you turn on your device or while you are using the device, it prompts you to enter one of the following codes:

- **Password:** When the device lock feature is enabled, you must enter the password you set for the device.
- **PIN:** When using the device for the first time or when the PIN requirement is enabled, you must enter the PIN supplied with the SIM or USIM card. You can disable this feature by using the Lock SIM card menu.
- **PUK:** Your SIM or USIM card is blocked, usually as a result of entering your PIN incorrectly several times. You must enter the PUK supplied by your service provider.
- **PIN2:** When you access a menu requiring the PIN2, you must enter the PIN2 supplied with the SIM or USIM card. For details, contact your service provider.

Your device displays network or service error messages

- When you are in areas with weak signals or poor reception, you may lose reception. Move to another area and try again. While moving, error messages may appear repeatedly.
- You cannot access some options without a subscription. Contact your service provider for more details.

Your device does not turn on

- When the battery is completely discharged, your device will not turn on. Charge the battery completely before turning on the device.
- The battery may not be inserted properly. Insert the battery again.
- Wipe both gold-coloured contacts and insert the battery again.

The touch screen responds slowly or improperly

- If you attach a protective cover or optional accessories to the touch screen, the touch screen may not function properly.
- If you are wearing gloves, if your hands are not clean while touching the touch screen, or if you tap the screen with sharp objects or your fingertips, the touch screen may malfunction.
- The touch screen may malfunction in humid conditions or when exposed to water.
- Restart your device to clear any temporary software bugs.
- Ensure that your device software is upgraded to the latest version.
- If the touch screen is scratched or damaged, visit a Samsung Service Centre.

Your device freezes or has fatal errors

If your device freezes or hangs, you may need to close applications or reinsert the battery and turn on the device to regain functionality. If your device is frozen and unresponsive, press and hold the Power button for more than 7 seconds to reboot.

If this does not solve the problem, perform a factory data reset. On the Applications screen, tap **Settings** → **GENERAL** → **Backup and reset** → **Factory data reset** → **RESET DEVICE** → **ERASE EVERYTHING**. Before performing the factory data reset, remember to make backup copies of all important data stored on the device.

If the problem is still not resolved, contact a Samsung Service Centre.

Calls are not connected

- Ensure that you have accessed the right cellular network.
- Ensure that you have not set call barring for the phone number you are dialling.
- Ensure that you have not set call barring for the incoming phone number.

Others cannot hear you speaking on a call

- Ensure that you are not covering the built-in microphone.
- Ensure that the microphone is close to your mouth.
- If using a headset, ensure that it is properly connected.

Sound echoes during a call

Adjust the volume by pressing the Volume button or move to another area.

A cellular network or the Internet is often disconnected or audio quality is poor

- Ensure that you are not blocking the device's internal antenna.
- When you are in areas with weak signals or poor reception, you may lose reception. You may have connectivity problems due to issues with the service provider's base station. Move to another area and try again.
- When using the device while moving, wireless network services may be disabled due to issues with the service provider's network.

The battery icon is empty

Your battery is low. Recharge or replace the battery.

The battery does not charge properly (For Samsung-approved chargers)

- Ensure that the charger is connected properly.
- If the battery terminals are dirty, the battery may not charge properly or the device may turn off. Wipe both gold-coloured contacts and try charging the battery again.
- The batteries in some devices are not user-replaceable. To have the battery replaced, visit a Samsung Service Centre.

The battery depletes faster than when first purchased

- When you expose the battery to very cold or very hot temperatures, the useful charge may be reduced.
- Battery consumption increases when you use messaging features or some applications, such as games or the Internet.
- The battery is consumable and the useful charge will get shorter over time.

Your device is hot to the touch

When you use applications that require more power or use applications on your device for an extended period of time, your device may feel hot to the touch. This is normal and should not affect your device's lifespan or performance.

Error messages appear when launching the camera

Your device must have sufficient available memory and battery power to operate the camera application. If you receive error messages when launching the camera, try the following:

- Charge the battery or replace it with a battery that is fully charged.
- Free some memory by transferring files to a computer or deleting files from your device.
- Restart the device. If you are still having trouble with the camera application after trying these tips, contact a Samsung Service Centre.

Photo quality is poorer than the preview

- The quality of your photos may vary, depending on the surroundings and the photography techniques you use.
- If you take photos in dark areas, at night, or indoors, image noise may occur or images may be out of focus.

Error messages appear when opening multimedia files

If you receive error messages or files do not play, when opening multimedia files on your device, try the following:

- Free some memory by transferring files to a computer or deleting files from your device.
- Ensure that the music file is not Digital Rights Management (DRM)-protected. If the file is DRM-protected, ensure that you have the appropriate licence or key to play the file.
- Ensure that your device supports the file type.

- Your device supports photos and videos captured with the device. Photos and videos captured by other devices may not work properly.
- Your device supports multimedia files that are authorised by your network service provider or providers of additional services. Some content circulated on the Internet, such as ringtones, videos, or wallpapers, may not work properly.

Another Bluetooth device is not located

- Ensure that the Bluetooth wireless feature is activated on your device.
- Ensure that the Bluetooth wireless feature is activated on the device you wish to connect to.
- Ensure that your device and the other Bluetooth device are within the maximum Bluetooth range (10 m).

If the tips above do not solve the problem, contact a Samsung Service Centre.

A connection is not established when you connect the device to a computer

- Ensure that the USB cable you are using is compatible with your device.
- Ensure that you have the proper driver installed and updated on your computer.
- If you are a Windows XP user, ensure that you have Windows XP Service Pack 3 or higher installed on your computer.
- Ensure that you have Samsung Kies or Windows Media Player 10 or higher installed on your computer.

Your device cannot find your current location

GPS signals may be obstructed in some locations, such as indoors. Set the device to use Wi-Fi or a mobile network to find your current location in these situations.

Data stored on the device has been lost

Always make backup copies of all important data stored on the device. Otherwise, you cannot restore data if it is corrupted or lost. Samsung is not responsible for the loss of data stored on the device.

A small gap appears around the outside of the device case

- This gap is a necessary manufacturing feature and some minor rocking or vibration of parts may occur.
- Over time, friction between parts may cause this gap to expand slightly.

Some content may differ from your device depending on the region, service provider, or software version, and is subject to change without prior notice.

