



Double oven HBM43B2.0B



BOSCH

[en] Instruction manual

en Table of contents

| | | | |
|---|-----------|---|-----------|
| Important safety information | 3 | Changing the basic settings | 12 |
| Causes of damage | 5 | Care and cleaning | 12 |
| Your new oven | 5 | Cleaning agents..... | 12 |
| Control panel | 5 | Detaching and refitting the rails..... | 13 |
| Buttons and display..... | 5 | Detaching and attaching the oven door..... | 13 |
| Function selector..... | 6 | Cleaning the door panels..... | 14 |
| Temperature selector..... | 6 | Troubleshooting | 15 |
| Cooking compartment | 6 | Malfunction table..... | 15 |
| Your accessories | 7 | Replacing the oven light bulb | 15 |
| Inserting accessories | 7 | Glass cover..... | 15 |
| Optional accessories | 7 | After-sales service | 15 |
| After-sales service products | 9 | E number and FD number | 15 |
| Before using for the first time | 9 | Energy and environment tips | 16 |
| Setting the clock | 9 | Saving energy..... | 16 |
| Heating up the oven..... | 9 | Environmentally-friendly disposal..... | 16 |
| Cleaning accessories..... | 9 | Tested for you in our cooking studio | 16 |
| Setting the oven | 9 | Cakes and pastries | 16 |
| Switching on the oven..... | 9 | Baking tips | 18 |
| Switching off the oven..... | 9 | Meat, poultry, fish | 19 |
| Rapid heating | 10 | Tips for roasting and grilling..... | 22 |
| Setting the time-setting options | 10 | Preprepared products..... | 22 |
| Timer | 10 | Special dishes..... | 23 |
| Cooking time | 10 | Defrost | 24 |
| End time | 11 | Drying..... | 24 |
| Clock | 11 | Acrylamide in foodstuffs | 24 |
| Childproof lock | 12 | Test dishes | 25 |
| Switching on the childproof lock | 12 | Baking | 25 |
| Switching off the childproof lock..... | 12 | Grilling..... | 25 |

Additional information on products, accessories, replacement parts and services can be found at www.bosch-home.com and in the online shop www.bosch-eshop.com

Important safety information

Read these instructions carefully. Only then will you be able to operate your appliance safely and correctly. Retain the instruction manual and installation instructions for future use or for subsequent owners.

This appliance is only intended to be fully fitted in a kitchen. Observe the special installation instructions.

Check the appliance for damage after unpacking it. Do not connect the appliance if it has been damaged in transport.

Only a licensed professional may connect appliances without plugs. Damage caused by incorrect connection is not covered under warranty.

This appliance is intended for domestic use only. The appliance must only be used for the preparation of food and drink. The appliance must be supervised during operation. Only use this appliance indoors.

This appliance may be used by children over the age of 8 years old and by persons with reduced physical, sensory or mental capacity or by persons with a lack of experience or knowledge if they are supervised or are instructed by a person responsible for their safety how to use the appliance safely and have understood the associated hazards.

Children must not play with the appliance. Children must not clean the appliance or carry out general maintenance unless they are at least 8 years old and are being supervised.

Keep children below the age of 8 years old at a safe distance from the appliance and power cable.

Always slide accessories into the cooking compartment correctly. See "*Description of accessories*" in the instruction manual.

Risk of fire!

- Combustible items stored in the cooking compartment may catch fire. Never store combustible items in the cooking compartment. Never open the appliance door if there is smoke inside. Switch off the appliance and unplug it from the mains or switch off the circuit breaker in the fuse box.
- A draught is created when the appliance door is opened. Greaseproof paper may come into contact with the heating element and catch fire. Do not place greaseproof paper loosely over accessories during preheating. Always weight down the greaseproof paper with a dish or a baking tin. Only cover the surface required with greaseproof paper. Greaseproof paper must not protrude over the accessories.

Risk of burns!

- The appliance becomes very hot. Never touch the interior surfaces of the cooking compartment or the heating elements. Always allow the appliance to cool down. Keep children at a safe distance.
- Accessories and ovenware become very hot. Always use oven gloves to remove accessories or ovenware from the cooking compartment.
- Alcoholic vapours may catch fire in the hot cooking compartment. Never prepare food containing large quantities of drinks with a high alcohol content. Only use small quantities of drinks with a high alcohol content. Open the appliance door with care.

Risk of scalding!

- The accessible parts become hot during operation. Never touch the hot parts. Keep children at a safe distance.
- When you open the appliance door, hot steam may escape. Open the appliance door with care. Keep children at a safe distance.
- Water in a hot cooking compartment may create hot steam. Never pour water into the hot cooking compartment.

Risk of injury!

Scratched glass in the appliance door may develop into a crack. Do not use a glass scraper, or sharp or abrasive cleaning aids or detergents.

Risk of electric shock!

- Incorrect repairs are dangerous. Repairs may only be carried out by one of our trained after-sales engineers. If the appliance is faulty, unplug the mains plug or switch off the fuse in the fuse box. Contact the after-sales service.
- The cable insulation on electrical appliances may melt when touching hot parts of the appliance. Never bring electrical appliance cables into contact with hot parts of the appliance.
- Penetrating moisture may cause an electric shock. Do not use any high-pressure cleaners or steam cleaners.
- When replacing the cooking compartment bulb, the bulb socket contacts are live. Before replacing the bulb, unplug the appliance from the mains or switch off the circuit breaker in the fuse box.
- A defective appliance may cause electric shock. Never switch on a defective appliance. Unplug the appliance from the mains or switch off the circuit breaker in the fuse box. Contact the after-sales service.

Causes of damage

Caution!

- Accessories, foil, greaseproof paper or ovenware on the cooking compartment floor: do not place accessories on the cooking compartment floor. Do not cover the cooking compartment floor with any sort of foil or greaseproof paper. Do not place ovenware on the cooking compartment floor if a temperature of over 50 °C has been set. This will cause heat to accumulate. The baking and roasting times will no longer be correct and the enamel will be damaged.
- Water in a hot cooking compartment: do not pour water into the cooking compartment when it is hot. This will cause steam. The temperature change can cause damage to the enamel.
- Moist food: do not store moist food in the cooking compartment when it is closed for prolonged periods. This will damage the enamel.
- Fruit juice: when baking particularly juicy fruit pies, do not pack the baking tray too generously. Fruit juice dripping from

the baking tray leaves stains that cannot be removed. If possible, use the deeper universal pan.

- Cooling with the appliance door open: only allow the cooking compartment to cool when it is closed. Even if the appliance door is only open a little, front panels of adjacent units could be damaged over time.
- Very dirty door seal: If the door seal is very dirty, the appliance door will no longer close properly when the appliance is in use. The fronts of adjacent units could be damaged. Always keep the door seal clean.
- Appliance door as a seat, shelf or worktop: Do not sit on the appliance door, or place or hang anything on it. Do not place any cookware or accessories on the appliance door.
- Inserting accessories: depending on the appliance model, accessories can scratch the door panel when closing the appliance door. Always insert the accessories into the cooking compartment as far as they will go.
- Carrying the appliance: do not carry or hold the appliance by the door handle. The door handle cannot support the weight of the appliance and could break.

Your new oven

Here you will learn about your new oven. The control panel and the individual operating controls are explained. You will find information on the cooking compartment and the accessories.

Control panel

Here is an overview of the control panel. The display never shows all of the symbols at the same time. Details may vary, depending on the appliance model.

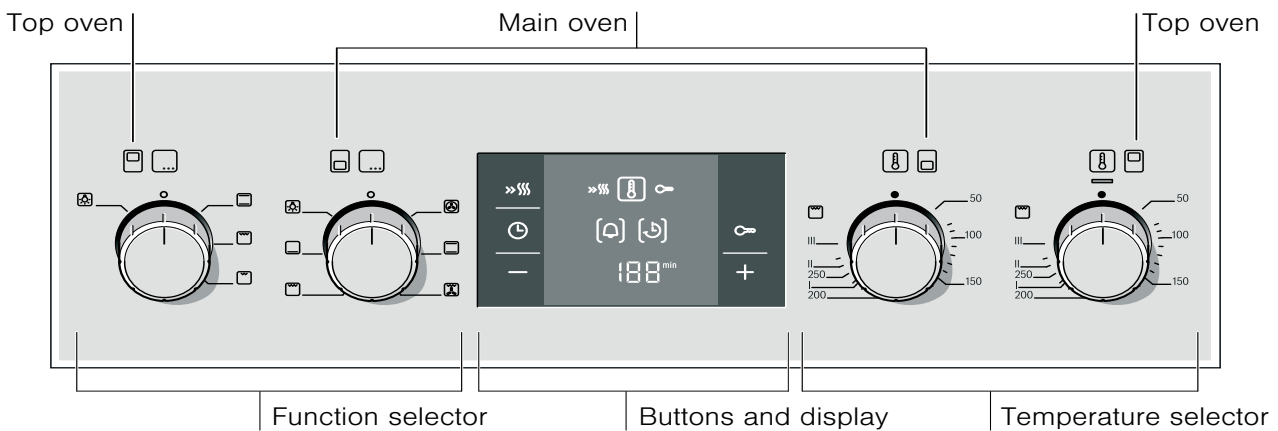

Control knobs

The control knobs can be popped out. Simply press the control knob when it is in the off position to pop it in or out.

Buttons

The sensors are located under the individual buttons. They must not be pressed too firmly. Only touch the corresponding symbol.

Buttons and display

You can use the buttons to set various additional functions. You can read the values that you have set in the display.





| Button | Use |
|------------------------|--|
| »»»» Rapid heating | Heats up the oven particularly quickly. |
| 🕒 Time-setting options | Selects the timer 🕒, cooking time 🕒, end time 🕒 and clock 🕒. |
| 🔒 Childproof lock | Locks and unlocks the control panel. |
| - Minus | Decreases the set values. |
| + Plus | Increases the set values. |

The time-setting option that is currently selected in the display is indicated by the brackets [] around the corresponding symbol. Exception: for the clock, the 🕒 symbol only lights up when you are making changes.

Function selector





Use the function selectors to set the type of heating.

Main oven

| Setting | Use |
|---|--|
| <input type="radio"/> Off position | The main oven is switched off. |
|  3D hot air* | For cakes and pastries on one or more levels. The fan distributes the heat from the heating ring in the back panel evenly around the cooking compartment. |
|  Top/bottom heating | For cakes, bakes and lean joints of meat, e.g. beef or game, on one level. The heat is emitted evenly from above and below. |
|  Hot air grilling | Joints of meat, poultry and whole fish. The grill heating element and the fan switch on and off alternately. The fan causes the hot air to swirl around the dish. |
|  Grill, large area | For grilling steaks, sausages, toast and pieces of fish. The whole area below the grill heating element becomes hot. |
| <input type="checkbox"/> Bottom heating | For preserving and final baking or crisp browning. Heat is emitted from below. |
|  Oven light | Switches on the oven light. |

* Type of heating used to determine the energy efficiency class according to EN50304.

Top oven



| Setting | Use |
|--|---|
| <input type="radio"/> Off position | The top oven is switched off. |
|  Top/bottom heating* | For cakes, bakes and lean joints of meat, e.g. beef or game, on one level. The heat is emitted evenly from above and below. |
|  Grill, large area | For grilling steaks, sausages, toast and pieces of fish. The whole area below the grill heating element becomes hot. |
|  Grill, small area | For grilling small quantities of steaks, sausages, toast and pieces of fish. The centre part of the grill heating element becomes hot. |
|  Oven light | Switches on the oven light. |

* Type of heating used to determine the energy efficiency class according to EN50304.

When you make settings, the oven light in the cooking compartment switches on.

Temperature selector

Set the temperature or grill setting using the temperature selector.

| Setting | Meaning |
|------------------------------------|--|
| <input type="radio"/> Off position | The oven does not heat up. |
| 50-270 Temperature range | The temperature in the cooking compartment in °C. |
| I, II, III Grill settings | The grill settings for the  Grill, small area and  Grill, large area. I = level 1, low II = level 2, medium III = level 3, high |

When the main oven is heating, the  symbol lights up in the display. When the top oven is heating, the indicator lamp for the temperature lights up. They go out during heating pauses.

Cooking compartment

The oven light is located in the cooking compartment. A cooling fan protects the oven from overheating.

Oven light

During operation, the oven light in the cooking compartment is on. The  setting on the function selector can be used to switch on the light without heating the oven.

Cooling fan

The cooling fan switches on and off as required. The hot air escapes above the door. Caution: do not cover the ventilation slots. Otherwise the oven will overheat.

So that the cooking compartment cools down more quickly after operation, the cooling fan continues to run for a certain period afterwards.

Your accessories

The accessories supplied with your appliance are suitable for making many meals. Ensure that you always insert the accessories into the cooking compartment the right way round.

There is also a selection of optional accessories, with which you can improve on some of your favourite dishes, or simply to make working with your oven more convenient.

Inserting accessories

When sliding the accessories into the cooking compartment, ensure that the kink in the side rail is at the back. Only then will they lock in place.

The accessories can be pulled out approximately halfway until they lock in place. This allows meals to be removed easily.

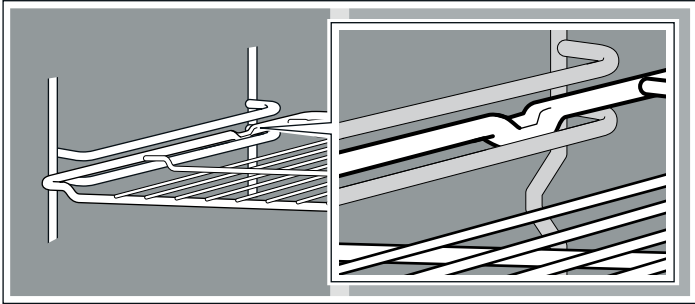

Note: The accessories may become deformed when they become hot. Once they cool down again, they regain their original shape. This does not affect their function.

☐ Main oven

You can insert the accessories into the cooking compartment at 5 different levels. Always insert them as far as they will go so that the accessories do not touch the door panel.

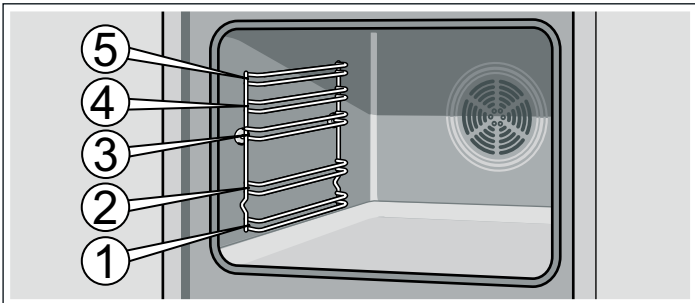

☐ Top oven

You can insert the accessories into the cooking compartment at 2 different levels. Always insert them as far as they will go so that the accessories do not touch the door panel.

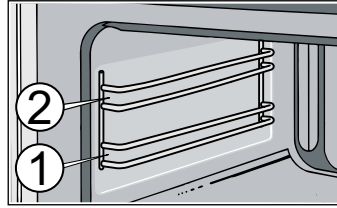

You can buy accessories from the after-sales service, from specialist retailers or online. Please specify the HEZ number.



Wire rack

For ovenware, cake tins, joints, grilled items and frozen meals.

Insert the wire rack with the open side facing the oven door and the curvature pointing downwards.

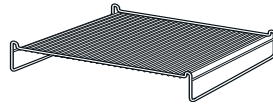

Insert grid

For roasting.

Place the wire insert in the universal pan with the legs facing downwards. This ensures that dripping fat and meat juices are collected.



Universal pan

For moist cakes, pastries, frozen meals and large roasts. It can also be used to catch dripping fat when you are grilling directly on the wire rack.

Slide in the universal pan with the sloping edge facing the oven door.

Optional accessories

You can purchase optional accessories from the after-sales service or specialist retailers. You will find a comprehensive range of products for your oven in our brochures and on the Internet. The availability of optional accessories and the option for ordering these online varies from country to country. Please see the sales brochures for more details.

Not all optional accessories are suitable for every appliance. When purchasing, please always quote the exact designation (E-no.) of your appliance.

| Optional accessories | HEZ number | Use |
|----------------------|------------|--|
| Wire rack | HEZ334000 | For ovenware, cake dishes, joints, grilled items and frozen meals. |
| Enamel baking tray | HEZ331003 | For cakes and biscuits. Push the baking tray into the oven with the sloping edge facing towards the oven door. |
| universal pan | HEZ332003 | For moist cakes, baked items, frozen meals and large joints. It can also be used to catch dripping fat when grilling directly on the wire rack. Slide the universal pan into the oven with the sloping edge facing the oven door. |
| Wire insert | HEZ324000 | For roasting. Always place the wire rack in the universal pan. This ensures that dripping fat and meat juices are collected. |

| Optional accessories | HEZ number | Use |
|--|-------------------|--|
| Grill tray | HEZ325000 | Use for grilling in place of the wire rack or as a splatter guard, so that the oven does not become as dirty as it otherwise might. Only use the grill tray in the universal pan. Grilling on the grill tray: only use at shelf position 1, 2 and 3. Using the grill tray as a splatter guard: insert the universal pan with the grill tray under the wire rack. |
| Pizza tray | HEZ317000 | Ideal for pizza, frozen products or large round cakes. You can use the pizza tray instead of the universal pan. Place the baking tray on the wire rack and proceed according to the details in the tables. |
| Bakestone | HEZ327000 | The bakestone is perfect for preparing home-made bread, bread rolls and pizzas which require a crispy base. The bakestone must always be preheated to the recommended temperature. |
| Enamel baking tray with non-stick coating | HEZ331011 | Cakes and biscuits can be removed more easily from the baking tray. Push the baking tray into the oven with the sloping edge facing towards the oven door. |
| Universal pan with non-stick coating | HEZ332011 | Moist cakes, baked items, frozen meals and large joints can be removed more easily from the universal pan. Slide the universal pan into the oven with the sloping edge facing the oven door. |
| Profi extra-deep pan with wire insert | HEZ333003 | Ideally suited for preparing large amounts. |
| Lid for the Profi extra-deep pan | HEZ333001 | The lid converts the Profi extra-deep pan into the Profi roasting dish. |
| Glass roasting dish | HEZ915001 | The glass roasting dish is suitable for stews and bakes that are cooked in the oven. It is ideally suited to automatic programmes or automatic roasting. |
| Telescopic shelves | | |
| 2-level | HEZ338250 | The pull-out rails fitted at positions 2 and 3 allow you to pull accessories out further without them tipping. |
| 3-level | HEZ338352 | The pull-out rails fitted at positions 1, 2 and 3 allow you to pull accessories out further without them tipping. The 3-level pull-out is not suitable for appliances that have a rotary spit. |
| 3-level complete pull-out | HEZ338356 | The pull-out rails fitted at positions 1, 2 and 3 allow you to pull accessories out fully without them tipping. The 3-level complete pull-out is not suitable for appliances that have a rotary spit. |
| 3-level complete pull-out with stop function | HEZ338357 | The pull-out rails fitted at positions 1, 2 and 3 allow you to pull accessories out fully without them tipping. The pull-out rails lock in position allowing accessories to be easily placed on top. The 3-level complete pull-out with stop function is not suitable for appliances that have a rotary spit. |
| Self-cleaning side walls | | |
| Appliance with an oven light | HEZ339020 | You can retrofit side walls so that the cooking compartment automatically cleans itself during operation. |
| Appliances with an oven light and automatic roasting | HEZ339020 | You can retrofit side walls so that the cooking compartment automatically cleans itself during operation. |
| Self-cleaning oven ceiling and side walls | | |
| Appliances with one oven light and a folding grill element | HEZ329020 | You can retrofit the ceiling and side walls so that the cooking compartment automatically cleans itself during operation. |
| Appliances with two oven lights and a folding grill element | HEZ329023 | You can retrofit the ceiling and side walls so that the cooking compartment automatically cleans itself during operation. |
| Appliances with one oven light, a folding grill element and a meat thermometer | HEZ329027 | You can retrofit the ceiling and side walls so that the cooking compartment automatically cleans itself during operation. |
| Steam filter | HEZ329000 | You can retrofit this to your oven. The steam filter filters out grease particles from the exhaust air, thereby reducing odours. Only for appliances with a 6, 7 or 8 as the second digit in the E-no.(e.g. HBA3 <u>8</u> B750) |
| System steamer | HEZ24D300 | For a gentler preparation of vegetables and fish. |

After-sales service products

You can obtain suitable care and cleaning agents and other accessories for your domestic appliances from the after-sales

service, specialist retailers or (in some countries) online via the e-Shop. Please specify the relevant product number.

| | | |
|--|--------------------|--|
| Cleaning cloths for stainless-steel surfaces | Product no. 311134 | Reduces the build-up of dirt. Impregnated with a special oil for perfect maintenance of your appliance's stainless-steel surfaces. |
| Oven and grill cleaning gel | Product no. 463582 | For cleaning the cooking compartment. The gel is odourless. |
| Microfibre cloth with honeycomb structure | Product no. 460770 | Especially suitable for cleaning delicate surfaces, such as glass, glass ceramic, stainless steel or aluminium. The microfibre cloth removes liquid and grease deposits in one go. |
| Door lock | Product no. 612594 | To prevent children from opening the oven door. The locks on different types of appliance door are screwed in differently. See the information sheet supplied with the door lock. |

Before using for the first time

Here, you will find out what you have to do before preparing food with your oven for the first time. Read the Safety information section beforehand.

Setting the clock

After the appliance has been connected, the  symbol and four zeros flash in the display. Set the clock.

1. Press the  button.

The clock in the display shows 12:00. The time symbols light up and the brackets are around .

2. Use the **+** or **-** button to set the clock.

After a few seconds, the time that has been set is adopted.

Heating up the oven

To get rid of the new cooker smell, heat up the oven when it is empty and closed. An hour of  Top/bottom heating at 240 °C is ideal. Make sure that there are no packaging remains in the cooking compartments.

1. Use the function selectors to set  Top/bottom heating.
2. Set 240 °C on the temperature selectors.
Turn the oven off after one hour. To do this, turn all function selectors to the off position.

Cleaning accessories

Before using the accessories for the first time, clean them thoroughly using hot, soapy water and a soft cloth.

Setting the oven

There are various ways in which you can set your oven. Here we will explain how you can select the desired type of heating and temperature or grill setting. You can select the oven cooking time and end time for your dish. Please refer to the section on *Setting the time-setting options*.

Switching on the oven

Example shown below: Setting the Top/bottom heating to 190 °C in the  main oven.

1. Use the function selector to set the type of heating.

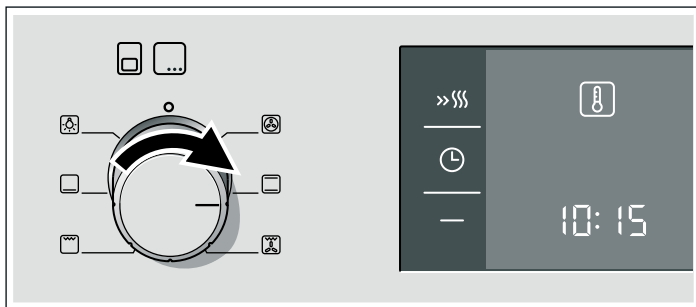

2. Set the temperature or grill setting using the temperature selector.

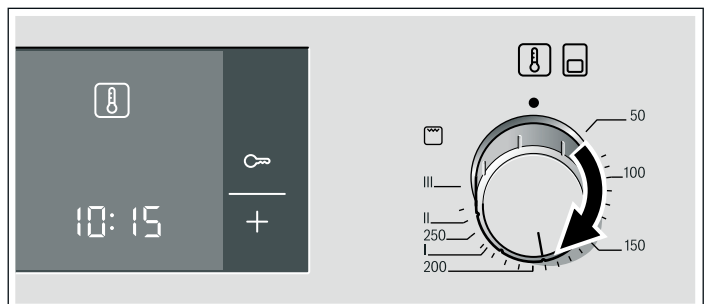

The oven begins to heat up.

Changing the settings

The type of heating and temperature or grill setting can be changed at any time with their respective selector.



Switching off the oven

Turn the function and temperature selector to the off position.

Rapid heating

You can switch on »»» rapid heating for the  main oven. The main oven will then reach the set temperature particularly quickly.

Use rapid heating when temperatures above 100 °C are selected. The following heating types are suitable:

- 3D hot air 
-  Top/bottom heating

To ensure an even cooking result, do not place your dish in the cooking compartment until rapid heating is complete.

1. Set the heating type and temperature for the main oven.
2. Press the »»» button.
The »»» symbol lights up in the display. The main oven begins to heat up.



The rapid heating process is complete.

A signal sounds. The »»» symbol in the display goes out. Place your dish in the main oven.

Cancelling rapid heating



Press the »»» button. The »»» symbol in the display goes out.

Setting the time-setting options

The  main oven has various time-setting options. You can use the  button to access the menu and switch between the individual options. All the time symbols are lit during the time when you can make settings. The [] brackets show you which time-setting function you have currently selected. A time-setting option which has already been set can be changed directly using the + or - button, when its time symbol is in brackets.

Timer

You can use the timer as a kitchen timer. It runs independently of the oven. The timer has its own signal. In this way, you can tell whether it is the timer or a cooking time which has elapsed.

1. Press the  button once.
The time symbols light up in the display and the brackets are around .
2. Use the + or - button to set the timer duration.
Default value for +button = 10 minutes
Default value for -button = 5 minutes

After a few seconds, the time setting is adopted. The timer starts. The  symbol lights up in the display and the timer duration counts down. The other time symbols go out.

The timer duration has elapsed

A signal sounds. 00:00 is shown in the display. Use the  button to switch off the timer.

Changing the timer duration





Use the + or - button to change the timer duration. After a few seconds, the change is adopted.

Cancelling the timer duration

Use the - button to reset the timer duration to 00:00. The change will be adopted after a few seconds. The timer is switched off.

Checking the time settings



If several time-setting options are set, the relevant symbols are illuminated on the display. The symbol for the time-setting option that is visible in the display is shown in brackets.

To call up the  timer,  cooking time,  end time or  clock, press the  button repeatedly until the brackets are around the relevant symbol. The display shows the value for a few seconds.

Cooking time

You can set a cooking time for your dish in the  main oven. When the cooking time has elapsed, the oven switches itself off automatically. This means that you do not have to interrupt other work to switch off the oven. The cooking time cannot be accidentally exceeded.

Example shown below: Cooking time of 45 minutes.

1. Use the function selector to adjust the type of heating for the main oven.
2. Use the temperature selector to set the temperature or grill setting for the main oven.
3. Press the  button twice. The display shows 00:00. The time symbols light up, the brackets are around .

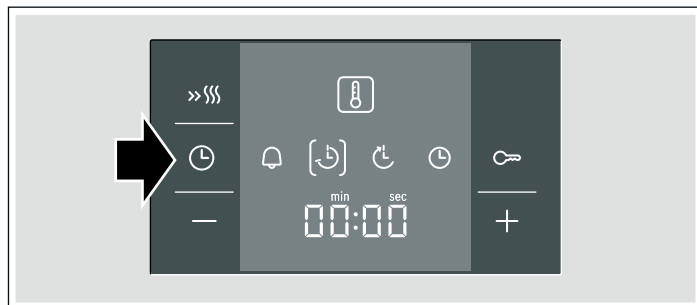



4. Use the + or - button to set the cooking time.
 - Default value for the + button = 30 minutes
 - Default value for the - button = 10 minutes



The main oven will start up after a few seconds. The cooking time counts down in the display and the  symbol lights up. The other time symbols go out.

The cooking time has elapsed

A signal sounds. The main oven stops heating. 00:00 is shown in the display. Press the  button. The + or - buttons can be used to set a new cooking time. Or press the  button twice and turn the function and temperature selector to the off position. The main oven is switched off.

Changing the cooking time

Use the **+** or **-** button to change the cooking time. After a few seconds, the change is adopted. If the timer has been set, press the **⏸** button beforehand.

Cancelling the cooking time

Use the **-** button to reset the cooking time to 00:00. After a few seconds, the change is adopted. The cooking time is cancelled. If the timer has been set, press the **⏸** button beforehand.

Checking the time settings

If several time-setting options are set, the relevant symbols are illuminated on the display. The symbol for the time-setting option that is visible in the display is shown in brackets.

To call up the **⏸** timer, **⏸** cooking time, **⏸** end time or **⏸** clock, press the **⏸** button repeatedly until the brackets are around the relevant symbol. The display shows the value for a few seconds.

End time

You can delay the time at which you wish your dish to be ready. The **⏸** main oven starts automatically and finishes at the desired time. You can, for example, put your dish in the compartment in the morning and set the cooking time so that it is ready at lunch time.

Ensure that food is not left in the cooking compartment for too long as it may spoil.

Example shown below: It is 10:30, the cooking time is 45 minutes and you want the oven to finish cooking at 12:30.

1. Set the function selector for the main oven.
2. Set the temperature selector for the main oven.
3. Press the **⏸** button twice.
4. Use the **+** or **-** button to set the cooking time.
5. Press the **⏸** button. The brackets are around **⏸**. The time when the dish will be ready is displayed.



6. Use button **+** or **-** to delay the end time.

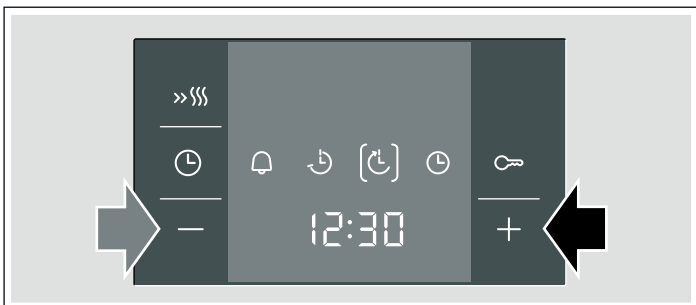

After a few seconds, the oven adopts the settings and switches to standby. The display shows the time at which the dish will be ready and the **⏸** symbol is in brackets. The symbols **⏸** and **⏸** go out. When the oven starts, the cooking time counts down in the display and the **⏸** symbol is shown in brackets. The **⏸** symbol goes out.

The cooking time has elapsed

A signal sounds. The main oven stops heating. 00:00 is shown in the display. Press the **⏸** button. The **+** or **-** buttons can be used to set a new cooking time. Or press the **⏸** button twice and turn the function and temperature selector to the off position. The main oven is switched off.

Changing the end time

Use the **+** or **-** button to change the end time. After a few seconds, the change is adopted. If the timer has been set, first press the **⏸** button twice. Do not change the end time if the cooking time has already started to elapse. The cooking result would no longer be correct.

Cancelling the end time

Use the **-** button to set the end time back to the current time. After a few seconds, the change is adopted. The main oven starts. If the timer has been set, first press the **⏸** button twice.

Checking the time settings

If several time-setting options are set, the relevant symbols are illuminated on the display. The symbol for the time-setting option that is visible in the display is shown in brackets.

To call up the **⏸** timer, **⏸** cooking time, **⏸** end time or **⏸** clock, press the **⏸** button repeatedly until the brackets are around the relevant symbol. The display shows the value for a few seconds.

Clock

After the appliance is connected or following a power cut, the **⏸** symbol and four zeros flash in the display. Set the clock.

1. Press the **⏸** button.
The clock in the display shows 12:00. The time symbols light up and the brackets are around **⏸**.
2. Use the **+** or **-** button to set the clock.
After a few seconds, the time that has been set is adopted.

Changing the clock

No other time-setting option should have been set.

1. Press the **⏸** button four times.
The time symbols light up in the display and the brackets are around **⏸**.
2. Use the **+** or **-** button to change the clock.
After a few seconds, the time that has been set is adopted.

Hiding the clock

You can hide the clock. For more information, please refer to the section *Changing the basic settings*.

Childproof lock

The  main oven has a childproof lock to prevent children from switching it on by accident or changing a setting.

The main oven does not respond to any settings. You can still set the clock and the timer when the childproof lock is activated.

If the heating type and temperature or grill setting are set for the main oven, the childproof lock interrupts the heater element.

Switching on the childproof lock

No cooking time or end time may be set.

Press and hold the  button for approximately 4 seconds.

The  symbol appears in the display. The childproof lock is activated.

Switching off the childproof lock

Press and hold the  button for approximately 4 seconds.

The  symbol in the display goes out. The childproof lock is deactivated.

Changing the basic settings

Your oven has various basic settings. These settings can be customised to suit your requirements.

| Basic setting | Selection 1 | Selection 2 | Selection 3 |
|---|--------------------|--|--------------------|
| c1 Clock display | always* | only with the  button | - |
| c2 Signal duration upon completion of a cooking time or timer period | approx. 10 seconds | approx. 2 minutes* | approx. 5 minutes |
| c3 Waiting time until a setting is applied | approx. 2 seconds | approx. 5 seconds* | approx. 10 seconds |

* Factory setting

No other time-setting option should have been set.

1. Press and hold the  button for approx. 4 seconds.

The current basic setting for the clock display is shown in the display, e.g. c1 1 for selection 1.

2. Use the **+** or **-** button to change the basic setting.

3. Confirm by pressing the  button.

The next basic setting appears in the display. You can scroll through all levels with the  button and change the setting with the **+** or **-** button.

4. To finish, press and hold the  button for approx. 4 seconds.

All basic settings are applied.

You may change the basic settings at any time.

Care and cleaning

With good care and cleaning, your oven will remain clean and fully-functioning for a long time to come. Here we will explain how to maintain and clean your oven correctly.

Notes

- Slight differences in the colours on the front of the oven are caused by the use of different materials, such as glass, plastic and metal.
- Shadows on the door panel which look like streaks, are caused by reflections made by the oven light.
- Enamel is baked on at very high temperatures. This can cause some slight colour variations. This is normal and does not affect their function. The edges of thin trays cannot be completely enamelled. As a result, these edges can be rough. This will not impair the anti-corrosion protection.

Cleaning agents

To ensure that the different surfaces are not damaged by using the wrong cleaning agent, observe the information in the table. Do not use

- sharp or abrasive cleaning agents,
- cleaning agents with a high concentration of alcohol,
- hard scouring pads or sponges,
- high-pressure cleaners or steam cleaners.

Wash new sponge cloths thoroughly before use.

| Area | Cleaning agents |
|--------------------------------|--|
| Oven front | Hot soapy water: Clean with a dish cloth and dry with a soft cloth. Do not use glass cleaners or glass scrapers. |
| Stainless steel | Hot soapy water: Clean with a dish cloth and dry with a soft cloth. Remove flecks of limescale, grease, starch and albumin (e.g. egg white) immediately. Corrosion can form under such residues. Special stainless steel cleaning products suitable for warm surfaces are available from our after-sales service or from specialist retailers. Apply a thin layer of the cleaning product with a soft cloth. |
| Door panels | Glass cleaner: Clean with a soft cloth. Do not use a glass scraper. |
| Glass cover for the oven light | Hot soapy water: Clean with a dish cloth. |
| Seal Do not remove. | Hot soapy water: Clean with a dish cloth. Do not scour. |
| Shelves | Hot soapy water: Soak and clean with a dish cloth or brush. |

| Area | Cleaning agents |
|--------------------|---|
| Telescopic shelves | Hot soapy water: Clean with a dish cloth or a brush. Do not soak or clean in the dishwasher. |
| Accessories | Hot soapy water: Soak and clean with a dish cloth or brush. |

Cleaning self-cleaning surfaces in the cooking compartment

The back panels, ceiling and side panels of the cooking compartment are coated with self-cleaning enamel. This coating absorbs and dispels splashes from baking and roasting while the oven is in operation. The higher the temperature and the longer the oven is in operation the better the result will be.

If dirt is still visible after operating the oven several times, clean the back panel, ceiling and side panels with hot soapy water and a soft cloth.

Over time, discolourations may occur, which can no longer be removed. These will not damage the enamel.

Caution!

Damage to surfaces on self-cleaning areas due to applying oven cleaner. Never clean the self-cleaning surfaces with oven cleaner.

If oven cleaner accidentally gets onto self-cleaning surfaces, remove it immediately with a sponge and plenty of water.

Caution!

Damage to surfaces on self-cleaning areas due to the use of abrasive and acidic cleaning agents and aids.

Do not use cleaning agents containing abrasive substances or acids.

Do not use abrasive cleaning aids such as steel wool or scourers.

Cleaning the cooking compartment floor

Use a dish cloth and hot soapy water or a vinegar solution.

If there are heavy deposits of dirt, use a stainless steel scouring pad or oven cleaner. Only use when the cooking compartment is cold. Never treat the self-cleaning surfaces with a scouring pad or oven cleaner.

Detaching and refitting the rails

The rails can be removed for cleaning. The oven must have cooled down.

Detaching the rails

1. Lift up the front of the rail
2. and unhook it (figure A).
3. Then pull the whole rail forward
4. and remove it (Fig. B).

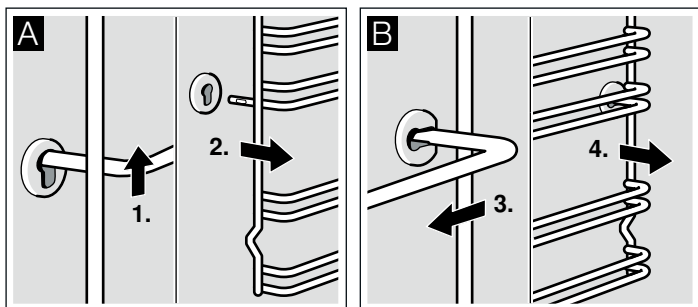

Clean the rails with cleaning agent and a sponge. For stubborn deposits of dirt, use a brush.

Refitting the rails

1. First insert the rail into the rear socket, press it to the back slightly (figure A),
2. and then hook it into the front socket (figure B).

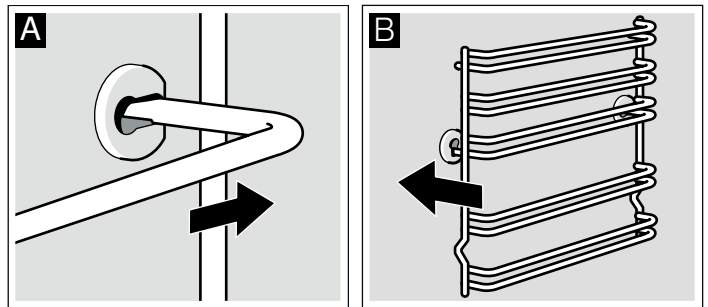

The rails fit both the left and right sides. Ensure that, as shown in figure B, levels 1 and 2 are below and levels 3, 4 and 5 are above.

Detaching and attaching the oven door

For cleaning purposes and to remove the door panels, you can detach the oven door.

The oven door hinges each have a locking lever. When the locking levers are closed (figure A), the oven door is secured in place. It cannot be detached. When the locking levers are open in order to detach the oven door (Fig. B), the hinges are locked. They cannot snap shut.

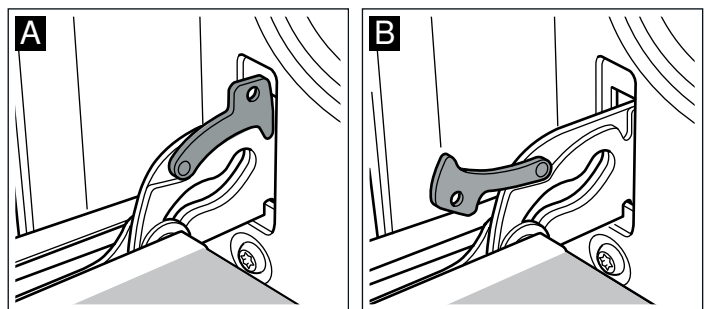

⚠ Risk of injury!

Whenever the hinges are not locked, they snap shut with great force. Ensure that the locking levers are always fully closed or, when detaching the oven door, fully open.

Detaching the door

1. Open the oven door fully.
2. Fold up the two locking levers on the left and right (figure A).
3. Close the oven door as far as the limit stop. With both hands, grip the door on the left and right-hand sides. Close the door a little further and pull it out (figure B).

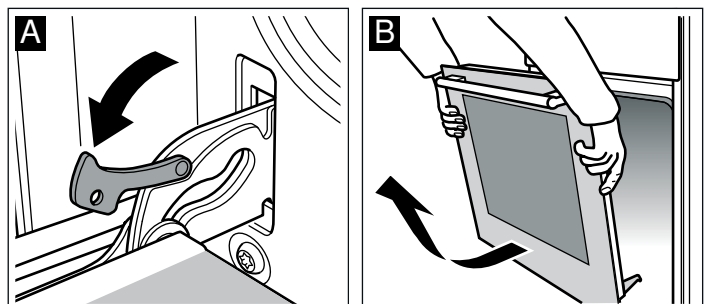

Attaching the door

Reattach the oven door in the reverse sequence to removal.

1. When attaching the oven door, ensure that both hinges are inserted straight into the opening (figure A).
2. The notch on the hinge must engage on both sides (figure B).

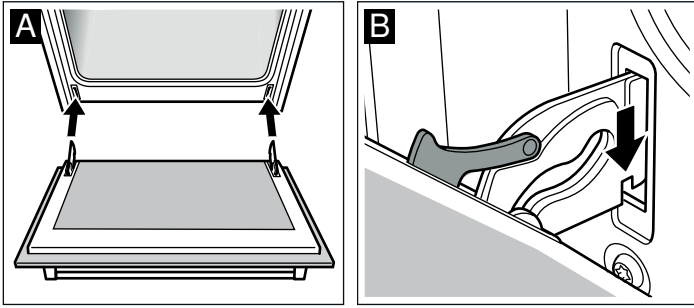

3. Fold back both locking levers (figure C). Close the oven door.

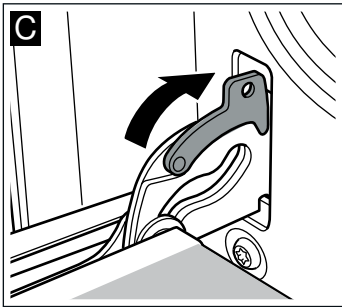

⚠ Risk of injury!

If the oven door falls out accidentally or a hinge snaps shut, do not reach into the hinge. Call the after-sales service.

Cleaning the door panels

To facilitate cleaning, you can remove the inner door panels from the appliance door.

⚠ Risk of injury!

The components inside the appliance door may have sharp edges. Take care not to cut yourself. Wear protective gloves.

⚠ Risk of injury!

The appliance must not be used again until the door panels and appliance door have been correctly fitted.

Removing the door panel

Note: Before removing, make a note of which way round the door panel is fitted, so that it is not refitted the wrong way round.

1. Unhook the appliance door and lay it on a soft, clean surface with the front side facing downwards (see section: Removing and installing the appliance door).
2. Pull off the cover at the top of the appliance door. Press in the tabs on the left and right using your fingers (fig.A).
3. Lift the door panel slightly and pull it out (Fig. B).

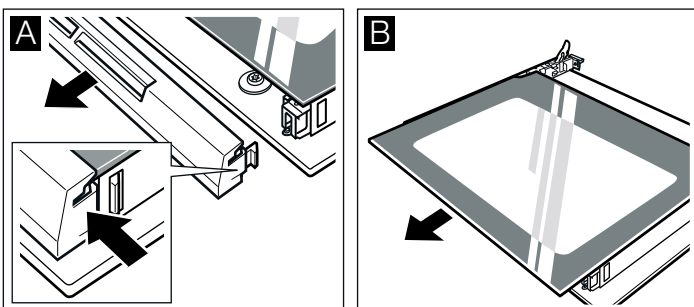

Removing the intermediate panel

Lift the intermediate panel slightly and pull it out towards you.

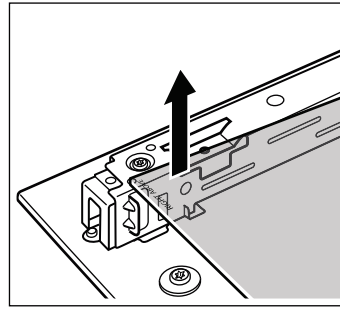

Cleaning

Clean the door panel with glass cleaner and a soft cloth.

⚠ Risk of injury!

Scratched glass in the appliance door may develop into a crack. Do not use a glass scraper, or sharp or abrasive cleaning aids or detergents.

Fitting the intermediate panel

Note: During installation, make sure that the lettering "top right" is upside down at the bottom left.

Insert the intermediate panel towards the back as far as it will go.

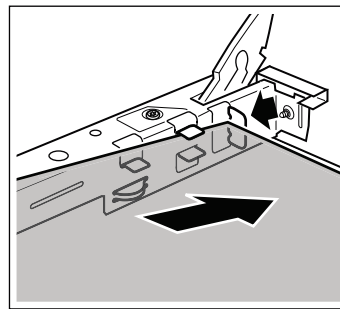

Fitting the door panel

1. Insert the door panel at an angle towards the back into both brackets as far as it will go. The smooth surface must face outwards.

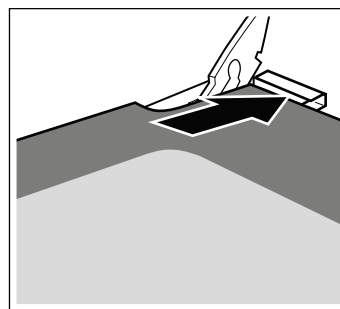

2. Put the cover back in place and press on it until it clicks in place.
3. Refit the appliance door.

Troubleshooting

Malfunctions often have simple explanations. Refer to the table before calling the after-sales service as you may be able to remedy the fault yourself.

Malfunction table

If a dish does not turn out as well as you had hoped, refer to the section *Tested for you in our cooking studio*, where you will find plenty of cooking tips and notes.

| Problem | Possible cause | Remedy/information |
|-----------------------------------|-----------------------------------|--|
| The oven does not work. | The circuit breaker is defective. | Look in the fuse box and check that the circuit breaker is in working order. |
| | Power cut | Check whether the kitchen light or other kitchen appliances are working. |
| ⊕ and zeros flash in the display. | Power cut | Reset the clock. |
| The oven does not heat up. | There is dust on the contacts. | Turn the control knobs back and forth several times. |

Error messages

If an error message with **E** appears, press the ⊕ button. The message disappears. A time function that has been set is cleared. If the error message does not disappear, please contact the after-sales service.

You can take remedial action yourself if the following error message is displayed.

| Error message | Possible cause | Remedy/information |
|---------------|---|---|
| E011 | A button was depressed for too long or is covered up. | Press all buttons individually. Check whether any buttons are jammed, covered up or soiled. |

Risk of electric shock!

Incorrect repairs are dangerous. Repairs may only be carried out by one of our trained after-sales engineers.

After-sales service

Our after-sales service is there for you if your appliance needs to be repaired. We will always find the right solution in order to avoid unnecessary visits from a service technician.

E number and FD number

When calling us, please give the product number (E no.) and the production number (FD no.) so that we can provide you with the correct advice. The rating plate containing these numbers can be found on the right-hand side of the oven door. You can make a note of the numbers of your appliance and the telephone number of the after-sales service in the space below to save time should it be required.

| | |
|-------|--------|
| E no. | FD no. |
|-------|--------|

After-sales service 

Replacing the oven light bulb

Replace faulty oven light bulbs.

Spare bulbs can be obtained from the after-sales service or specialist retailers. Only use these oven light bulbs.

- For the main oven: E14, 220 - 240 V, 40 W, heat-resistant to 300 °C.
- For the top oven: E14, 220 - 240 V, 25 W, heat-resistant to 300 °C.

Risk of electric shock !

Disconnect the appliance from the power supply. Switch off the circuit breaker or remove the fuse from the household fuse box.

1. Place a tea towel in the cold cooking compartment to prevent damage.
2. Turn the glass cover anticlockwise and remove it.

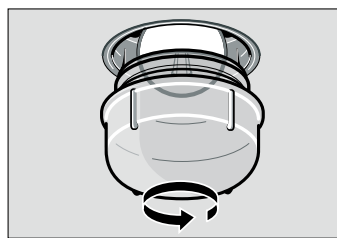

3. Replace the oven light bulb with a bulb of the same type.
4. Screw on the glass cover again.
5. Remove the tea towel and switch on the circuit breaker.

Note: Use rubber gloves if the glass cover cannot be unscrewed: Or order a special removal tool from the after-sales service:

- For the main oven: Order no. 613634
- For the top oven: Order no. 621743

Glass cover

You must replace a damaged glass cover. Suitable glass covers may be obtained from the after-sales service. Please specify the E number and FD number of your appliance.

Please note that there will be a fee for a visit by a service technician in the event of a malfunction, even during the warranty period.

Please find the contact data of all countries in the enclosed customer service list.

To book an engineer visit and product advice

GB 0844 8928979
Calls from a BT landline will be charged at up to 3 pence per minute. A call set-up fee of up to 6 pence may apply.

IE 01450 2655

Trust the expertise of the manufacturer, and rest assured that the repair will be carried out by trained service technicians using original spare parts for your domestic appliance.

Energy and environment tips

Here you can find tips on how to save energy when baking and roasting and how to dispose of your appliance properly.

Saving energy

- Only preheat the oven if this is specified in the recipe or in the operating instruction tables.
- Use dark, black lacquered or enamelled baking tins. They absorb the heat particularly well.
- Open the oven door as infrequently as possible while you are cooking, baking or roasting.
- It is best to bake several cakes one after the other. The oven is still warm. This reduces the baking time for the second cake. You can also place two loaf tins next to each other.

- For longer cooking times, you can switch the oven off 10 minutes before the end of the cooking time and use the residual heat to finish cooking.

Environmentally-friendly disposal

Dispose of packaging in an environmentally-friendly manner.



This appliance complies with European Directive 2002/96/EC on Waste Electrical and Electronic Equipment (WEEE). The directive gives a framework for the collection and recycling of old appliances, which is valid across the EU.

Tested for you in our cooking studio

Here you will find a selection of dishes and the ideal settings for them. We will show you which type of heating and which temperature are best suited for your dish. You can find information about suitable accessories and the height at which they should be inserted. There are also tips about cookware and preparation methods.

Notes

- The values in the table always apply to dishes placed into the cooking compartment when it is cold and empty.
Only preheat the appliance if the table specifies that you should do so. Do not line the accessories with greaseproof paper until after they have been preheated.
- The times specified in the tables are guidelines only. They will depend on the quality and composition of the food.
- Use the accessories supplied. Additional accessories may be obtained as special accessories from specialist retailers or from the after-sales service.
Before using the oven, remove any unnecessary accessories and ovenware from the cooking compartment.
- Always use oven gloves when taking hot accessories or ovenware out of the cooking compartment.

Cakes and pastries

Baking on one level

When baking cakes, the best results can be achieved using  Top/bottom heating.

When baking with  3D hot air, use the following shelf heights for the accessory:

- Cakes in tins: level 2
- Cakes on trays: level 3

Baking on two or more levels

Use  3D hot air.

Baking on 2 levels

- Wire rack or universal pan at shelf position 3
- Wire rack at shelf position 1.

Baking on 3 levels:

- Wire rack at shelf position 5
- Universal pan at shelf position 3
- Wire rack at shelf position 1.

Baking trays that are placed in the oven at the same time will not necessarily be ready at the same time.

The tables show numerous suggestions for your dishes.

If you have 2 small, round cake tins, place them on one level next to each other on the wire rack.

If you have 4 small, round cake tins, place 2 next to each other on each wire rack. Slide in the wire racks one above the other.

If you are baking with 3 loaf tins at the same time, place these on the wire racks as indicated in the picture.

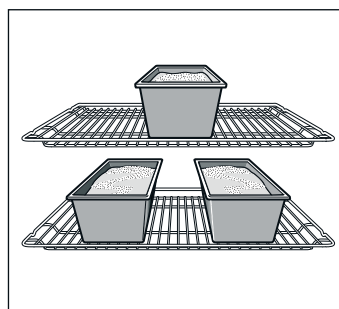

Baking tins

It is best to use dark-coloured metal baking tins.

Baking times are increased when light-coloured baking tins made of thin metal or glass dishes are used, and cakes do not brown so evenly.

If you wish to use silicone baking tins, use the information and recipes provided by the manufacturer as a guide. Silicone baking tins are often smaller than normal tins. The amount of mixture and recipe instructions may differ.





































Tables

The tables show the ideal type of heating for the various cakes and pastries. The temperature and baking time depend on the amount and composition of the mixture. This is why temperature ranges are given in the tables. You should try the lower temperature first, since a lower temperature results in more even browning. You can increase the temperature next time if necessary.

If you preheat the oven, the baking time is shortened by 5 to 10 minutes.

Additional information can be found in the *Baking tips* section following the tables.

 **Main oven**

| Food | Dish | Shelf position | Type of heating | Temperature in °C | Baking time in minutes |
|------------------------|--|----------------|---|-------------------|------------------------|
| Victoria sandwich | Wire rack + 2 x dia. 20 cm tins | 2 |  | 170-180 | 20-25 |
| | | 3 |  * | 160-180 | 20-25 |
| Light fruit cake | Wire rack + deep tin, dia. 20 cm | 2 |  | 160-170 | 80-90 |
| | | |  * | 150-160 | 80-90 |
| Rich fruit cake | Wire rack + deep round tin, dia. 23 cm, or square tin, 20 cm | 2 |  * | 130-140 | 180-190 |
| Fruit crumble | Wire rack + flat glass dish | 2 |  | 180-190 | 40-45 |
| | | 3 |  * | 160-170 | 40-45 |
| Sponge cake (fat-free) | Wire rack + baking tin (dark coated) | 2 |  * | 170-180 | 30-35 |
| | | |  * | 160-170 | 30-40 |
| Swiss roll | Universal pan + Swiss roll tin | 2 |  * | 190-200 | 10-12 |
| | Wire rack + Swiss roll tin | 3 |  * | 170-180 | 10-12 |
| Tart | Universal pan + plate or pie tin, dia. 20 cm | 1 |  | 200-210 | 50-60 |
| | Wire rack + plate or pie tin, dia. 20 cm | 3 |  * | 180-190 | 50-60 |
| Quiche | Wire rack + quiche tin (dark coated) | 1 |  | 190-200 | 45-50 |
| | | 3 |  * | 180-190 | 40-45 |
| (White) bread | Wire rack + loaf tin (1 x 900 g or 2 x 450 g) | 1 |  | 200-210 | 30-35 |
| | | 3 |  * | 190-200 | 25-30 |
| Scones | Universal pan | 3 |  | 190-200 | 15-20 |
| | | |  * | 180-190 | 15-20 |
| Biscuits | Universal pan | 3 |  | 160-170 | 15-20 |
| | | |  * | 160-170 | 15-20 |
| Small cakes | Wire rack + 12-cup tin | 3 |  * | 160-170 | 15-20 |
| | | |  * | 150-160 | 15-20 |
| Jam tarts | Wire rack + 12-cup tin | 2 |  | 200-210 | 15-20 |
| | | |  * | 180-190 | 15-20 |
| Meringues | Universal pan | 3 |  * | 80-90 | 100-150 |
| Pavlova | Universal pan | 3 |  | 150**+ 100 | 100-150 |
| Soufflé | Wire rack + 1.2 litre soufflé dish | 2 |  | 170-180 | 45-50 |
| | | |  * | 160-170 | 45-50 |
| Pie | Wire rack + pie dish | 1 |  | 190-200 | 45-55 |
| | | 3 |  * | 180-190 | 45-50 |
| Yorkshire pudding | Universal pan + 12-cup tin | 2 |  * | 200-210 | 20-25 |
| | | 3 |  * | 190-200 | 15-20 |
| Jacket potatoes | Universal pan | 3 |  * | 160-170 | 60-70 |
| Pizza (homemade) | Universal pan | 2 |  | 210-220 | 25-30 |
| | | 3 |  * | 210-220 | 20-25 |

* preheat

** preheat at higher temperature, then reduce and insert food

| Food | Dish | Shelf position | Type of heating | Temperature in °C | Baking time in minutes |
|-------------------------------|---|----------------|-----------------|-------------------|------------------------|
| Victoria sandwich 2 levels | 2 wire racks + 4 tins, dia. 20 cm | 3+1 | * | 160-170 | 30-35 |
| Scones 2 levels | Universal pan + wire rack with baking tray | 3+1 | * | 170-180 | 20-25 |
| Biscuits 2 levels | Universal pan + wire rack with baking tray | 3+1 | * | 150-160 | 20-25 |
| Biscuits 3 levels | Universal pan + 2 wire racks with baking trays | 5+3+1 | * | 140-150 | 25-35 |
| Small cakes 2 levels | 2 wire racks + 2 12-cup tins | 3+1 | * | 150-160 | 25-30 |
| Meringues 2 levels | Universal pan + wire rack with baking tray | 3+1 | * | 80-90 | 100-150 |
| Jacket potatoes 2 levels | 2 wire racks | 3+1 | * | 160-170 | 60-75 |
| (White) bread | 2 wire racks + loaf tins (2 x 900 g or 4 x 450 g) | 3+1 | * | 180-190 | 35-40 |
| Pizza (homemade) | Universal pan + wire rack with baking tray | 3+1 | * | 180-190 | 40-45 |

* preheat

Top oven

| Food | Dish | Shelf position | Type of heating | Temperature in °C | Time in minutes |
|-------------------|-------------------------------|----------------|-----------------|-------------------|-----------------|
| Victoria sandwich | Wire rack + 1 tin, dia. 20 cm | 1 | * | 160-170 | 25-30 |
| Scones | Wire rack + baking tray | 1 | * | 200-210 | 10-12 |
| Small cakes | Wire rack + 12-cup tin | 1 | * | 150-160 | 25-30 |
| Jam tarts | Wire rack + 12-cup tin | 1 | * | 190-210 | 15-25 |
| Swiss roll | Wire rack + Swiss roll tin | 1 | * | 180-190 | 10-15 |
| Biscuits | Wire rack + baking tray | 1 | * | 170-180 | 10-15 |
| Meringues | Wire rack + baking tray | 1 | * | 80 | 110-140 |

* Preheat.

Baking tips

| | |
|--|---|
| You want to bake following your own recipe. | Use similar items in the baking tables as a guide. |
| This way you will be able to establish whether the sponge cake is baked through. | Approximately 10 minutes before the end of the baking time specified in the recipe, stick a cocktail stick into the cake at the highest part. If the cocktail stick comes out clean, the cake is ready. |
| The cake collapses. | Use less fluid next time or set the oven temperature 10 degrees lower. Observe the specified mixing times in the recipe. |
| The cake has risen in the middle but has sunk around the edge.? | Do not grease the edge of the springform cake tin. After baking, loosen the cake carefully with a knife. |
| ?The cake goes too dark on top. | Place it lower in the oven, select a lower temperature and bake the cake for a little longer. |
| The cake is too dry. | When it is done, make small holes in the cake using a cocktail stick. Then drizzle fruit juice or an alcoholic drink over it. Next time, select a temperature 10 degrees higher and reduce the baking time. |
| The bread or cake (e.g. cheesecake) looks good but is sticky on the inside (soggy with wet streaks). | Use slightly less fluid next time and bake for slightly longer at a lower temperature. For cakes with a moist topping, bake the base first. Sprinkle it with almonds or bread crumbs and then place the topping on top. Please follow the recipe and stick to the baking times. |
| The cake is unevenly browned. | Select a slightly lower temperature to ensure that the cake is baked more evenly. Bake delicate pastries on one level using top/bottom heating. Greaseproof paper that protrudes over the food can affect the air circulation. For this reason, always cut the greaseproof paper to fit the baking tray. |
| The bottom of a fruit cake is too light. | Place the cake one level lower the next time. |
| The fruit juice overflows. | Next time, use the deeper universal pan, if you have one. |
| Small baked products made out of yeast dough stick to one another when baking. | There should be a distance of approx. 2 cm around each item. This gives enough space for the item to expand nicely and turn brown on all sides. |
| Condensation forms when you bake moist cakes. | Baking may result in the formation of water vapour, which escapes via the door. The steam may settle and form water droplets on the control panel or on the fronts of adjacent units. This is a normal physical process. |

Meat, poultry, fish

Ovenware

The universal pan with insert wire rack is suitable for large roasts. You may also use any heat-resistant ovenware.

Glass ovenware is the most suitable. Ensure that the lid of the roasting dish fits well and closes properly.

Add a little more liquid when using enamelled roasting dishes.

With roasting dishes made of stainless steel, browning is not so intense and the meat may be somewhat less well cooked. Increase the cooking times.

Always place the ovenware in the centre of the wire rack.

Place hot glass ovenware on a dry mat after cooking. The glass could crack if placed on a cold or wet surface.

Roasting

The information in the table applies to food placed in a cold oven and for meat taken directly from the refrigerator.

The joints of meat should weigh between 500 g and 2 kg.

Ensure that you always use the lower temperature, if the weight of the joint you wish to roast is high.

If there are several pieces of meat, calculate the roasting time using the weight of the heaviest piece of meat. The individual pieces of meat should be approximately the same size.

Meat

Turn pieces of meat halfway through the cooking time.

When the roast is ready, turn off the oven and allow it to rest for an additional 10 minutes. This allows better distribution of the meat juices.

After cooking, wrap sirloin in aluminium foil and leave it to rest for 10 minutes in the oven.

For roast pork with a rind, score the rind in a crossways pattern, then lay the roast in the dish with the rind at the bottom.

☐ Main oven

| Meat | Dish | Shelf position | Type of heating | Temperature in °C | Time, mins per 500 g + add. time |
|-------------------------------|---|----------------|-----------------|-----------------------------------|--|
| Beef | | | | | |
| Slow roast joint | Universal pan with roasting rack | 1 | ☐ | 130-140 | 40+40 |
| Top side and top rump | Universal pan with roasting rack | 1 | ☐ | 160-170 | 30+25 |
| Lamb | | | | | |
| Leg | Universal pan with roasting rack | 1 | ☐ | 160-170 | 30+25 |
| Shoulder (on the bone) | Universal pan with roasting rack | 1 | ☐ | 160-170 | 25+20 |
| Shoulder (boned and rolled) | Universal pan with roasting rack | 1 | ☐ | 170-180 | 25+25 |
| Rack of lamb | Universal pan with roasting rack | 1 | ☐ | 180-190 | 25+25 |
| Pork | | | | | |
| Roast joint | Universal pan with roasting rack | 1 | ☐ | 180-190 | 35+35 |
| Loin joint | Universal pan with roasting rack | 1 | ☐ | 170-180 | 30+30 |
| Belly | Universal pan with roasting rack | 1 | ☐ | 160-170 | 30+25 |
| Gammon joint | Universal pan with roasting rack | 1 | ☐ | 160-170 | 30+30 |
| Poultry | | | | | |
| Chicken | Universal pan with roasting rack | 1 | ☐ | 170-180 | 20+25 |
| Chicken, portion | Universal pan with roasting rack | 1 | ☐ | 190-200 | 20+25 |
| Chicken, quarter (450 g each) | Universal pan with roasting rack | 1 | ☐ | 180-190 | 20+25 |
| Duck | Universal pan with roasting rack | 1 | ☐ | 180-190 | 20+20 |
| Turkey, crown | Universal pan with roasting rack | 1 | ☐ | 160-170 | 15+15 |
| Casserole | | | | | |
| Diced meat (beef, pork, lamb) | Wire rack + glass roasting dish with lid | 2 | ☐ | 140 | 120-150 total time |
| Braising steaks | Wire rack + glass roasting dish with lid | 2 | ☐ | 140 | 120-150 total time |
| Chicken | Wire rack + glass roasting dish with lid | 2 | ☐ | 140 | 60-90 |
| Complete Meal | | | | | |
| With beef | Wire rack Universal pan with roasting rack | 4 1 | ☐ | 160, then 200 (Yorkshire pudding) | Weight of meat (see table above) + 15-25 for Yorkshire pudding |
| With chicken | Wire rack Universal pan with roasting rack | 4 1 | ☐ | 180 | Weight of chicken (see table above) |

| Meat | Dish | Shelf position | Type of heating | Temperature in °C | Time, mins per 500 g + add. time |
|-----------------------------------|----------------------------------|----------------|-----------------|-------------------|----------------------------------|
| Beef | | | | | |
| Top side and top rump | Universal pan with roasting rack | 2 | | 200-220 | 25+25 |
| Lamb | | | | | |
| Leg | Universal pan with roasting rack | 1 | | 150-170 | 30+35 |
| Rack of lamb | Universal pan with roasting rack | 1 | | 180-200 | 25+25 |
| Pork | | | | | |
| Roast joint | Universal pan with roasting rack | 1 | | 180-200 | 35+40 |
| Loin joint | Universal pan with roasting rack | 2 | | 190-210 | 25+50 |
| Belly | Universal pan with roasting rack | 1 | | 220-240 | 25+40 |
| Poultry | | | | | |
| Chicken | Universal pan with roasting rack | 1 | | 210-230 | 20+15 |
| Chicken, portion (200-250 g each) | Universal pan with roasting rack | 3 | | 210-230 | 25+25 |
| Chicken, quarter (450 g each) | Universal pan with roasting rack | 2 | | 220-240 | 20+25 |
| Duck | Universal pan with roasting rack | 1 | | 190-210 | 20+20 |

Grilling

When grilling, preheat the oven for approx. 3 minutes, before putting the food in.

Always grill with the oven door closed.

As far as possible, the pieces of food you are grilling should be of equal thickness. This will allow them to brown evenly and remain succulent and juicy.

Turn grilled items after the specified time.

Whole fish does not need to be turned. Place the whole fish in the oven in the swimming position with the dorsal fin pointing upwards. Placing a scored potato or a small oven-proof container in the stomach cavity of the fish will provide stability.

Do not add salt to steaks until they have been grilled.

Place the food to be grilled directly on the wire rack. If you are grilling a single piece, the best results are achieved by placing it in the centre of the wire rack.

The universal pan should also be inserted underneath. To prevent a high degree of smoke from forming, do not insert the pan higher than level 3. The meat juices are collected in the pan and the oven is kept cleaner.

Do not insert the baking tray or universal pan at level 4 or 5. The high heat distorts it and the cooking compartment can be damaged when removing it.

The grill element switches on and off continually. This is normal. The grill setting determines how frequently this will happen.

Main oven

| Food | Dish | Shelf position | Type of heating | Grill setting | Time in minutes |
|-------------------------|------------------------------|----------------|-----------------|---------------|-----------------|
| Beef | | | | | |
| Steaks 2-3 cm thick | Wire rack + universal pan | 5+ | | 3 | 1st side 4-5 |
| | | 3 | | | 2nd side 4-5 |
| Burgers 1-2 cm thick | Wire rack + universal pan | 5+ | | 3 | 1st side 6-8 |
| | | 3 | | | 2nd side 4-6 |
| Lamb | | | | | |
| Steaks 2-3 cm thick | Wire rack + universal pan | 5+ | | 3 | 1st side 6-7 |
| | | 3 | | | 2nd side 6-7 |
| Chops 2-3 cm thick | Wire rack + universal pan | 5+ | | 3 | 1st side 5-6 |
| | | 3 | | | 2nd side 5-6 |
| Pork | | | | | |
| Steaks 1-2 cm thick | Wire rack + universal pan | 5+ | | 3 | 1st side 6-7 |
| | | 3 | | | 2nd side 6-7 |
| Chops 2-3 cm thick | Wire rack + universal pan | 4+ | | 3 | 1st side 10-12 |
| | | 3 | | | 2nd side 9-10 |

| Food | Dish | Shelf position | Type of heating | Grill setting | Time in minutes |
|---------------------------------|------------------------------|----------------|-----------------|---------------|------------------------------|
| Burgers 1-2 cm thick | Wire rack + universal pan | 5+ 3 | | 3 | 1st side 6-8 2nd side 4-6 |
| Sausages 2-4 cm thick | Wire rack + universal pan | 4+ 3 | | 3 | 10-15, turn occasionally |
| Chicken | | | | | |
| Drumsticks 150 g each | Wire rack + universal pan | 3+ 2 | | 3 | 1st side 17 2nd side 8 |
| Breast (boneless) 150 g each | Wire rack + universal pan | 3+ 2 | | 3 | 1st side 20 2nd side 10 |
| Fish | | | | | |
| Whole trout 300 g each | Wire rack + universal pan | 2+ 1 | | 2 | 20-25 |
| Fillets 150 g each | Wire rack + universal pan | 4+ 3 | | 3 | 1st side 5-7 2nd side 5-7 |

Top oven

Observe the notes in the table about preheating.

| Food | Dish | Shelf position | Type of heating | Grill setting | Time in minutes |
|---------------------------------|------------------------------|----------------|-----------------|---------------|--------------------------------|
| Beef | | | | | |
| Steaks 2-3 cm thick | Wire rack + universal pan | 2+ 1 | * | 3 | 1st side 10-13, 2nd side 6-8 |
| Burgers 1-2 cm thick | Wire rack + universal pan | 2+ 1 | | 3 | 1st side 10-12, 2nd side 6-8 |
| Lamb | | | | | |
| Steaks 2-3 cm thick | Wire rack + universal pan | 2+ 1 | * | 3 | 1st side 6-8, 2nd side 4-6 |
| Chops 2-3 cm thick | Wire rack + universal pan | 2+ 1 | * | 3 | 1st side 7-9, 2nd side 5-8 |
| Pork | | | | | |
| Steaks 1-2 cm thick | Wire rack + universal pan | 2+ 1 | * | 3 | 1st side 9-12, 2nd side 6-8 |
| Chops 2-3 cm thick | Wire rack + universal pan | 2+ 1 | * | 3 | 1st side 10-13, 2nd side 8-12 |
| Burgers 1-2 cm thick | Wire rack + universal pan | 2+ 1 | | 3 | 1st side 10-12, 2nd side 6-8 |
| Sausages 2-4 cm thick | Wire rack + universal pan | 2+ 1 | | 3 | 14 - -18** |
| Chicken | | | | | |
| Drumsticks 150 g each | Wire rack + universal pan | 2+ 1 | | 2 | 1st side 16-20, 2nd side 12-15 |
| Breast (boneless) 150 g each | Wire rack + universal pan | 2+ 1 | | 2 | 1st side 13-15, 2nd side 8-10 |
| Fish | | | | | |
| Whole trout 300 g each | Wire rack + universal pan | 2+ 1 | | 1 | 25-30 |
| Fillets 150 g each | Wire rack + universal pan | 2+ 1 | | 1 | 15-20 |

* Preheat for 3 minutes

** Turn frequently

Tips for roasting and grilling

| | |
|---|---|
| The table does not contain information for the weight of the joint. | Select the next lowest weight from the instructions and extend the time. |
| How to tell when the roast is ready. | Use a meat thermometer (available from specialist shops) or carry out a "spoon test". Press down on the roast with a spoon. If it feels firm, it is ready. If the spoon can be pressed in, it needs to be cooked for a little longer. |
| The roast is too dark and the crackling is partly burnt. | Check the shelf height and temperature. |
| The roast looks good but the juices are burnt. | Next time, use a smaller roasting dish or add more liquid. |
| The roast looks good but the juices are too clear and watery. | Next time, use a larger roasting dish and use less liquid. |
| Steam rises from the roast when basted. | This is normal and due to the laws of physics. The majority of the steam escapes through the steam outlet. It may settle and form condensation on the cooler switch panel or on the fronts of adjacent units. |

Preprepared products

Observe the instructions on the packaging.





















If you line the accessories with greaseproof paper, make sure that the paper is suitable for these temperatures. Make sure the paper is a suitable size for the dish to be cooked.

The cooking result greatly depends on the quality of the food. Pre-browning and unevenness can sometimes even be found on the raw product.

Leave a little space between bread rolls when crisping them up. Do not place too many bread rolls on the accessories.

Sprinkle grated cheese over the top of your lasagne to give it a beautiful and evenly browned finish.

Main oven

| Food | Dish | Shelf position | Type of heating | Temperature in °C | Time in minutes |
|---|---------------------------|----------------|---|-------------------|-----------------|
| Pizza, frozen | | | | | |
| Pizza with a thin base | Universal pan | 2 |  | 190-210 | 15-25 |
| | | 3 |  * | 200-210 | 10-15 |
| Pizza with a thick base | Universal pan | 2 |  | 180-200 | 20-30 |
| | | 3 |  * | 200-210 | 15-20 |
| | Universal pan + wire rack | 3+1 |  * | 170-180 | 20-25 |
| Pizza baguette | Universal pan | 3 |  | 180-200 | 20-30 |
| | | |  * | 170-180 | 25-30 |
| Pizza, chilled | Universal pan | 3 |  * | 190-210 | 10-15 |
| | | |  * | 200-210 | 10-15 |
| Potato products, frozen | | | | | |
| Chips | Universal pan | 3 |  | 190-210 | 20-30 |
| | | |  * | 210-220 | 20-25 |
| | Universal pan + wire rack | 3+1 |  * | 180-190 | 30-35 |
| Duchess potatoes | Universal pan | 3 |  | 200-220 | 20-25 |
| | | |  * | 200-210 | 15-20 |
| Hash browns (fried potatoes), filled potato skins | Universal pan | 3 |  | 210-230 | 15-25 |
| | | |  * | 200-210 | 15-20 |
| Potato wedges | Universal pan | 2 |  * | 190-210 | 20-25 |
| | | 3 |  * | 190-210 | 20-25 |
| Baked goods, frozen | | | | | |
| Rolls, baguettes | Universal pan | 3 |  | 170-190 | 10-20 |
| | | |  * | 180-190 | 10-15 |

* preheat

| Food | Dish | Shelf position | Type of heating | Temperature in °C | Time in minutes |
|------------------------------|---------------------------|----------------|-----------------|-------------------|-----------------|
| Baked goods, prebaked | | | | | |
| Part-baked white bread | Universal pan | 3 | | 190-210 | 10-20 |
| | | | * | 180-190 | 15-20 |
| | Universal pan + wire rack | 3+1 | * | 160-170 | 20-25 |
| Fried foods, frozen | | | | | |
| Fish fingers | Universal pan | 2 | | 220-240 | 10-20 |
| | | 3 | * | 200-210 | 15-20 |
| Chicken nuggets | Universal pan | 3 | | 200-220 | 15-25 |
| | | | * | 170-180 | 20-25 |
| Food, frozen | | | | | |
| Lasagne, 400 g | Wire rack | 2 | | 190-210 | 35-40 |
| | | | * | 180-190 | 35-40 |
| Lasagne, 1200 g | Wire rack | 2 | | 190-210 | 50-60 |
| | | | * | 180-190 | 40-50 |
| Food, chilled | | | | | |
| Lasagne, 400 g | Wire rack | 2 | * | 170-180 | 20-25 |
| Lasagne, 1200 g | Wire rack | 2 | * | 170-180 | 30-35 |

* preheat

Special dishes

At low temperatures, 3D hot air is equally useful for producing creamy yoghurt as it is for proving light yeast dough. First, remove accessories, hook-in racks or telescopic shelves from the cooking compartment.

Preparing yoghurt

1. Bring 1 litre of milk (3.5 % fat) to the boil and cool down to 40 °C.
2. Stir in 150 g of yoghurt (chilled).

3. Pour into cups or small screw-top jars and cover with cling film.

4. Preheat the cooking compartment as indicated.

5. Place the cups or jars on the cooking compartment floor and incubate as indicated.

Proving dough

1. Prepare the dough as usual, place it in a heat-resistant ceramic dish and cover.
2. Preheat the cooking compartment as indicated.
3. Switch off the oven and place the dough in the cooking compartment and leave it to prove.

Main oven

| Meal | Cookware | | Type of heating | Temperature | Cooking time |
|---------------|------------------------|--|-----------------|---|--------------|
| Yoghurt | Cups or screw-top jars | Place on the cooking compartment floor | | Preheat to 50 °C | 5 mins |
| | | | | 50 °C | 8 hrs |
| Proving dough | Heat-resistant dish | Place on the cooking compartment floor | | Preheat to 50 °C | 5-10 mins |
| | | | | Switch off the appliance and place the yeast dough in the cooking compartment | 20-30 mins |

Upper oven

| Meal | Cookware | Level | Type of heating | Temperature | Cooking time |
|---------|------------------------|--|-----------------|---------------------------|---------------|
| Yoghurt | Cups or screw-top jars | Place on the cooking compartment floor | | Preheat to 100 °C | 15 mins |
| | | | | Switch on the oven light | approx. 8 hrs |

Defrost

The defrosting time will depend on the type and quantity of the food.

Observe the instructions on the packaging.

Take frozen food out of its packaging and place in suitable ovenware on the wire rack.

Place poultry on a plate with the breast side facing down.

| Frozen food | Accessories | Level | Type of heating | Temperature |
|--|-------------|-------|---|---|
| e.g. cream cakes, buttercream cakes, gateaux with chocolate or sugar icing, fruit, chicken, sausage and meat, bread and bread rolls, cakes and other baked items | wire rack | 1 |  | The temperature selector remains switched off |

Drying

With  3D hot air, you can dry foods brilliantly.





Use unblemished fruit and vegetables only and wash them thoroughly.

Drain off the excess water, then dry them.

Line the universal pan and the wire rack with greaseproof or parchment paper.

Turn very juicy fruit or vegetables several times.

Remove fruit and vegetables from the paper as soon as they have dried.

| Fruit and herbs | Accessories | Level | Type of heating | Temperature | Cooking time |
|-------------------------|----------------------|-------|--|-------------|--------------------|
| 600 g apple rings | Universal pan + rack | 3+1 |  | 80 °C | 5 hrs (approx.) |
| 800 g pear slices | Universal pan + rack | 3+1 |  | 80 °C | 8 hrs (approx.) |
| 1.5 kg damsons or plums | Universal pan + rack | 3+1 |  | 80 °C | 8-10 hrs (approx.) |
| 200 g herbs, washed | Universal pan + rack | 3+1 |  | 80 °C | 1½ hrs (approx.) |

Acrylamide in foodstuffs

Acrylamide is mainly produced in grain and potato products prepared at high temperatures, such as potato crisps, chips,

toast, bread rolls, bread or fine baked goods (biscuits, gingerbread, cookies).

Tips for keeping acrylamide to a minimum when preparing food

| | |
|----------------|---|
| General | <ul style="list-style-type: none"> ■ Keep cooking times to a minimum. ■ Cook meals until they are golden brown, but not too dark. ■ Large, thick pieces of food contain less acrylamide. |
| Baking | <p>With top/bottom heating max. 200 °C.</p> <p>With 3D hot air or hot air max. 180 °C.</p> |
| Biscuits | <p>With top/bottom heating max. 190 °C.</p> <p>With 3D hot air or hot air max. 170 °C.</p> <p>Egg or egg yolk reduces the production of acrylamide.</p> |
| Oven chips | <p>Spread evenly over the baking tray, in a single layer. Bake at least 400 g per baking tray so that the chips do not dry out</p> |

Test dishes

These tables have been produced for test institutes to facilitate the inspection and testing of the various appliances.

In accordance with EN 50304/EN 60350 (2009) and IEC 60350.

Baking

When baking on 2 levels, always insert the universal pan above the baking tray. When baking on 3 levels, insert the universal pan in the centre of the oven.













Piped cookies: Food on baking trays that are placed in the oven at the same time will not necessarily all be ready at the same time.

German apple pie on 2 levels: Place dark springform cake tins one above the other. German apple pie on 1 level: Place dark springform cake tins diagonally next to each other.

Cakes in tinplate springform cake tins: Bake on 1 level with  Top/bottom heating. Place the springform cake tins on the universal pan instead of on the wire rack.

Note: For baking, use the lower of the temperatures indicated first.



Main oven

| Meal | Accessories and tins | Level | Type of heating | Temperature in °C | Cooking time in minutes |
|-------------------------------|--|-------|---|-------------------|-------------------------|
| Piped cookies | baking tray | 3 |  | 160-180 | 20-30 |
| | baking tray | 3 |  | 160-180 | 20-30 |
| | Universal pan + baking tray | 3+1 |  | 150-170 | 30-40 |
| | Universal pan + 2 baking trays | 5+3+1 |  | 140-160 | 40-50 |
| Small cakes preheat | baking tray | 3 |  | 160-180 | 20-25 |
| | Universal pan + baking tray | 3+1 |  | 150-170 | 30-35 |
| | Universal pan + 2 baking trays | 5+3+1 |  | 140-160 | 30-35 |
| Small cakes | baking tray | 3 |  | 160-180 | 20-25 |
| Hot water sponge cake preheat | Springform cake tin on the wire rack | 2 |  | 170-190 | 30-40 |
| Hot water sponge cake | Springform cake tin on the wire rack | 2 |  | 160-180 | 30-40 |
| German apple pie | Wire rack + 2 springform cake tins, dia. 20 cm | 1 |  | 190-210 | 70-80 |
| | Wire rack + 2 springform cake tins, dia. 20 cm | 3+1 |  | 190-210 | 70-80 |

Grilling

If you are grilling food directly on the wire rack, the universal pan should also be inserted at level 1. The liquid is then collected, keeping the oven cleaner.

Main oven

| Meal | Accessories | Level | Type of heating | Grill setting | Cooking time in minutes |
|---|------------------------------|---------|---|---------------|-------------------------|
| Toast Preheat for 10 minutes | wire rack | 5 |  | 3 | 1/2-2 |
| Beefburgers, 12 pieces* do not preheat | Wire rack + Universal pan | 4+ 1 |  | 3 | 25-30 |

* turn over after 2/3 of the cooking time.

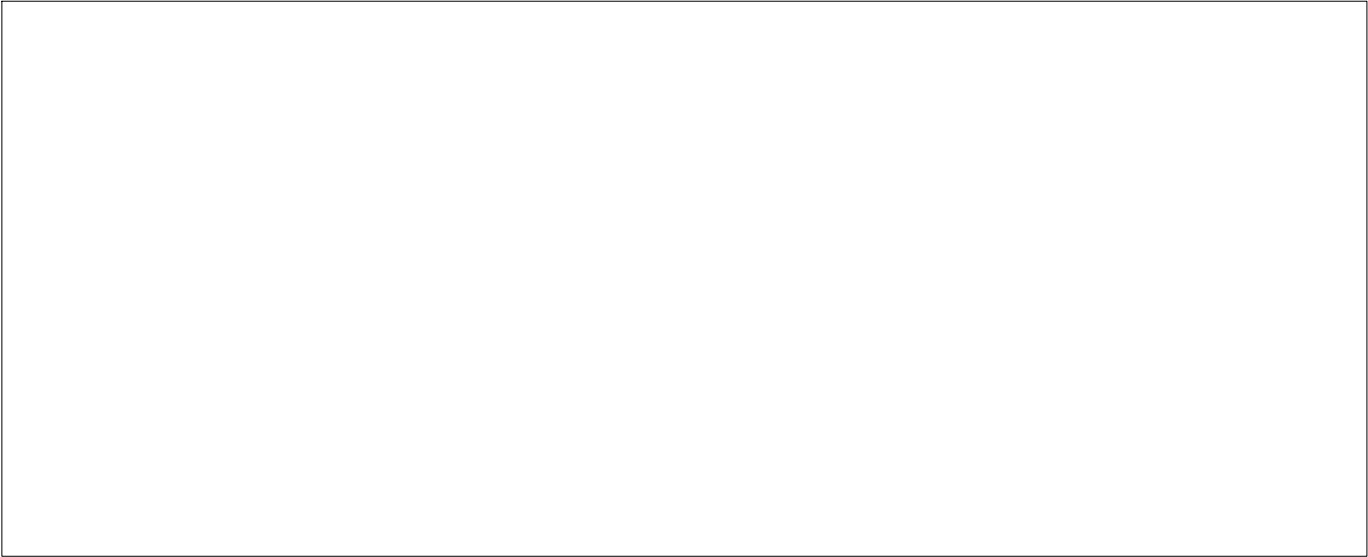

Robert Bosch Hausgeräte GmbH

Carl-Wery-Straße 34

81739 München

Germany

www.bosch-home.com



9000715713

920228