

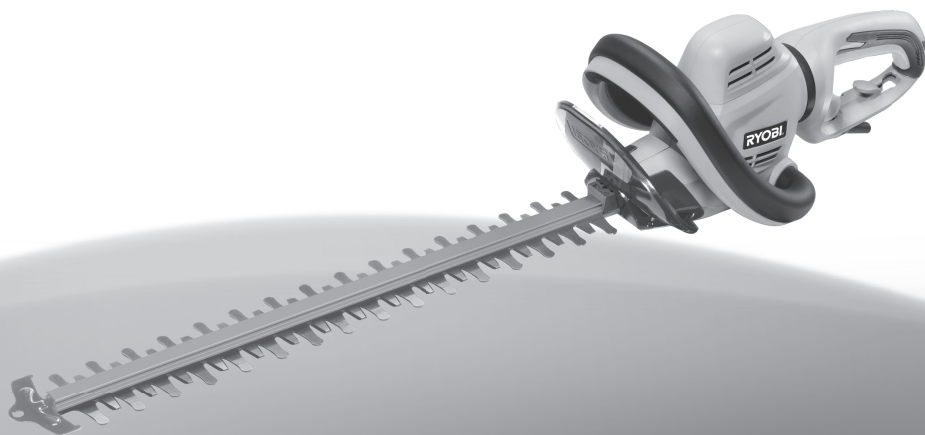

ORIGINAL INSTRUCTIONS
Electric Hedge Trimmer

RHT5555R

RHT6560RL



Important!

It is essential that you read the instructions in this manual before operating this machine.

Subject to technical modifications.



GENERAL SAFETY WARNINGS

⚠ WARNING

Read all safety warnings and all instructions. Failure to follow the warnings and instructions may result in electric shock, fire and/or serious injury.

Save all warnings and instructions for future reference.

The term "power tool" in the warnings refers to your mains-operated (corded) power tool or battery-operated (cordless) power tool.

WORK AREA SAFETY

- **Keep work area clean and well lit.** Cluttered or dark areas invite accidents.
- **Do not operate power tools in explosive atmospheres, such as in the presence of flammable liquids, gases or dust.** Power tools create sparks which may ignite the dust or fumes.
- **Keep children and bystanders away while operating a power tool.** Distractions can cause you to lose control.

ELECTRICAL SAFETY

- **Power tool plugs must match the outlet. Never modify the plug in any way. Do not use any adapter plugs with earthed (grounded) power tools.** Unmodified plugs and matching outlets will reduce risk of electric shock.
- **Avoid body contact with earthed or grounded surfaces, such as pipes, radiators, ranges and refrigerators.** There is an increased risk of electric shock if your body is earthed or grounded.
- **Do not expose to rain or damp conditions.** Water entering a power tool will increase the risk of electric shock.
- **Do not abuse the cord. Never use the cord for carrying, pulling or unplugging the power tool. Keep cord away from heat, oil, sharp edges or moving parts.** Damaged or entangled cords increase the risk of electric shock.
- **When operating a power tool outdoors, use an extension cord suitable for outdoor use.** Use of a cord suitable for outdoor use reduces the risk of electric shock.
- **If operating a power tool in a damp location is unavoidable, use a residual current device (RCD) protected supply.** Use of an RCD reduces the risk of electric shock.

PERSONAL SAFETY

- **Stay alert, watch what you are doing and use common sense when operating a power tool. Do not use a power tool while you are tired or under the influence of drugs, alcohol or medication.** A moment

of inattention while operating power tools may result in serious personal injury.

- **Use personal protective equipment. Always wear eye protection.** Protective equipment such as dust mask, non-skid safety shoes, hard hat, or hearing protection used for appropriate conditions will reduce personal injuries.
- **Prevent unintentional starting. Ensure the switch is in the off-position before connecting to power source and/or battery pack, picking up or carrying the tool.** Carrying power tools with your finger on the switch or energising power tools that have the switch on invites accidents.
- **Remove any adjusting key or wrench before turning the power tool on.** A wrench or a key left attached to a rotating part of the power tool may result in personal injury.
- **Do not overreach. Keep proper footing and balance at all times.** This enables better control of the power tool in unexpected situations.
- **Dress properly. Do not wear loose clothing or jewellery. Keep your hair, clothing and gloves away from moving parts.** Loose clothes, jewellery or long hair can be caught in moving parts.
- **If devices are provided for the connection of dust extraction and collection facilities, ensure these are connected and properly used.** Use of dust collection can reduce dust-related hazards.

POWER TOOL USE AND CARE

- **Do not force the product. Use the correct power tool for your application.** The correct power tool will do the job better and safer at the rate for which it was designed.
- **Do not use the power tool if the switch does not turn it on and off.** Any power tool that cannot be controlled with the switch is dangerous and must be repaired.
- **Disconnect the plug from the power source and/or the battery pack from the power tool before making any adjustments, changing accessories, or storing power tools.** Such preventive safety measures reduce the risk of starting the power tool accidentally.
- **Store idle power tools out of the reach of children and do not allow persons unfamiliar with the power tool or these instructions to operate the power tool.** Power tools are dangerous in the hands of untrained users.
- **Maintain power tools. Check for misalignment or binding of moving parts, breakage of parts and any other condition that may affect the power tool's operation. If damaged, have the power tool repaired before use.** Many accidents are caused by poorly maintained power tools.
- **Keep cutting tools sharp and clean.** Properly maintained cutting tools with sharp cutting edges are less likely to bind and are easier to control.
- **Use the power tool, accessories and tool bits etc.**



in accordance with these instructions, taking into account the working conditions and the work to be performed. Use of the power tool for operations different from those intended could result in a hazardous situation.

SERVICE

- **Have your power tool serviced by a qualified repair person using only identical replacement parts.** This will ensure that the safety of the power tool is maintained.

SPECIFIC SAFETY RULES

WARNING

This appliance is not intended for use by persons (including children) with reduced physical, sensory or mental capabilities, or lack of experience and knowledge, unless they have been given supervision or instruction concerning use of the appliance by a person responsible for their safety. Children should be supervised to ensure that they do not play with the appliance.

- **Keep all parts of the body away from the cutter blade. Do not remove cut material or hold material to be cut when blades are moving. Make sure the switch is off when clearing jammed material.** A moment of inattention while operating the hedge trimmer may result in serious personal injury.
- **Carry the hedge trimmer by the handle with the cutter blade stopped. When transporting or storing the hedge trimmer, always fit the cutting device cover.** Proper handling of the hedge trimmer will reduce possible personal injury from the cutter blades.
- **Hold the power tool by insulated gripping surfaces only.** The cutter blade may contact hidden wiring or its own cord. Cutter blade contacting "live" wire may expose metal parts of the power tool "live" and could give the operator an electric shock.
- **Keep cable away from cutting area.** During operation the cable may be hidden in shrubs and can be accidentally cut by blades.

ADDITIONAL

- **Carefully check the hedge before cutting for foreign objects such as, wire fences, posts or cables.**
- **If a residual current device is required, use a RCD with a tripping current of 30mA or less.**
- **Do not use the trimmer without front handle in place.** Keep both hands on handles when the unit is in use.
- **If the power cable becomes damaged, you must return the tool to an approved service centre for repair or replacement.**
- **Do not attempt to cut in areas or blind spots where you cannot see the entire blade.** Failure to observe

this warning may result in serious personal injury or damage to the tool.

RESIDUAL RISKS

- **It has been reported that vibrations from hand-held tools may contribute to a condition called Raynaud's Syndrome in certain individuals.** Symptoms may include tingling, numbness and blanching of the fingers, usually apparent upon exposure to cold. Hereditary factors, exposure to cold and dampness, diet, smoking and work practices are all thought to contribute to the development of these symptoms. It is presently unknown what, if any, vibrations or extent of exposure may contribute to the condition. There are measures that can be taken by the operator to possibly reduce the effects of vibration:
 - Keep your body warm in cold weather. When operating the unit wear gloves to keep the hands and wrists warm. It is reported that cold weather is a major factor contributing to Raynaud's Syndrome.
 - After each period of operation, exercise to increase blood circulation.
 - Take frequent work breaks. Limit the amount of exposure per day.

If you experience any of the symptoms of this condition, immediately discontinue use and see your physician about these symptoms.

- **The vibration level during actual use of the power tool can differ from the declared total value depending on the ways in which the tool is used.** Identify safety measures to protect yourself based on an estimation of exposure in the actual conditions of use, taking account of all parts of the operating cycle such as the times when the tool is switched off and when it is running idle in addition to the trigger time.

INTENDED USE

- This product is intended for cutting and trimming hedges, bushes and shrubs.
- It is intended for operation below shoulder level and for domestic use only.
- Do not use for any other purpose.

ENVIRONMENTAL PROTECTION



Recycle raw materials and waste electrical products instead of disposing of as waste. The machine, accessories and packaging should be sorted for environmental-friendly recycling.

SYMBOL



Safety alert



Safety



Please read the instructions carefully before starting the machine.



Wear eye and ear protection.



Do not expose to rain.



Remove plug from the mains immediately if the cable is damaged or cut.



Guaranteed sound power level.



Class II. Double insulation



CE Conformity



GOST-R Conformity



Waste electrical products should not be disposed of with household waste. Please recycle where facilities exist. Check with your local authority or retailer for recycling advice.

RHT555R



x 1

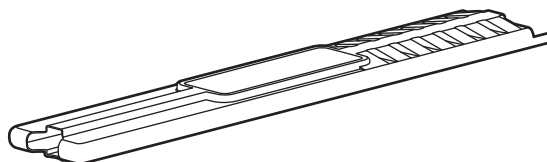

x 1

RHT6260RL

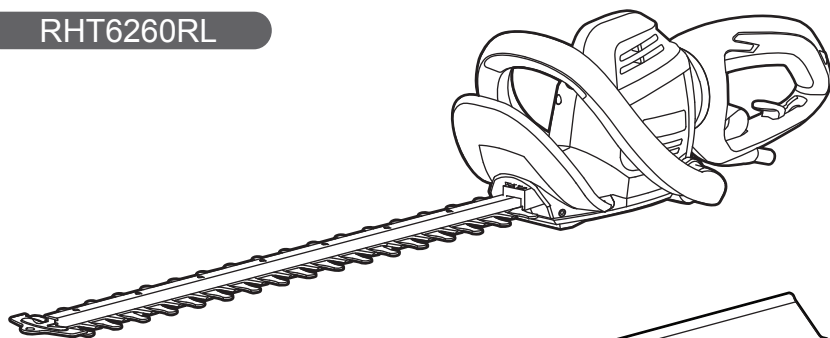

x 1

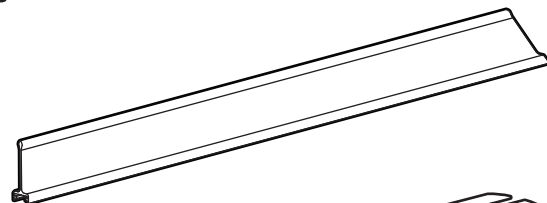

x 1

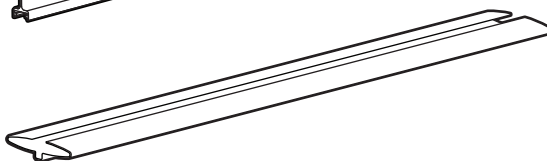

x 1

1

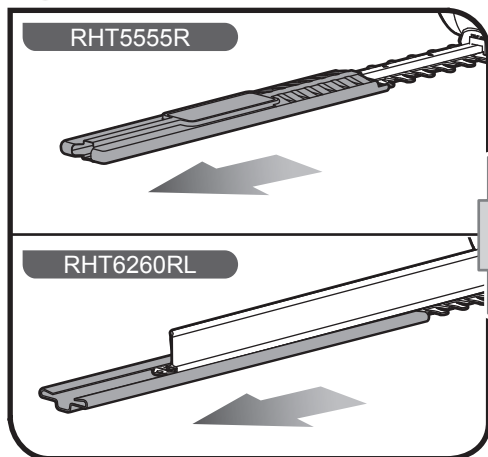

2

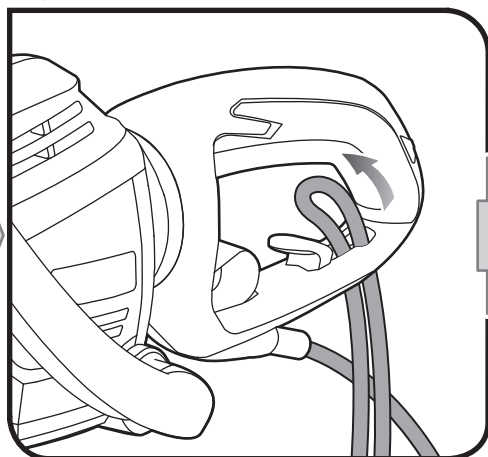

3

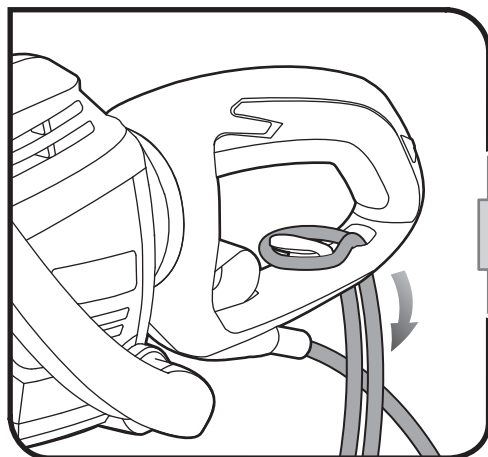

4

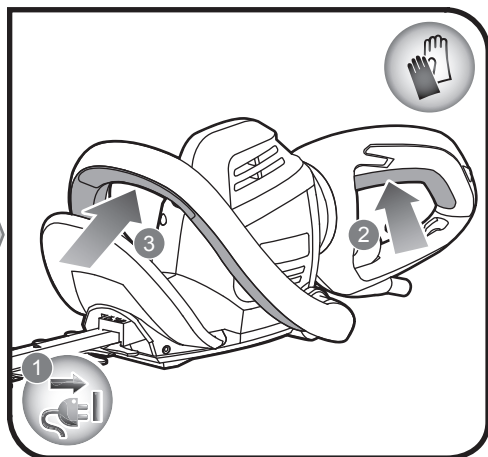



Overview

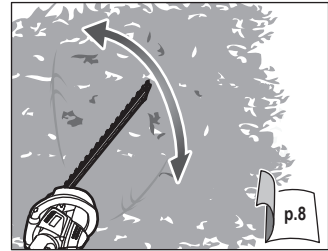
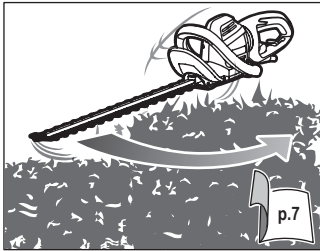

RHT5555R

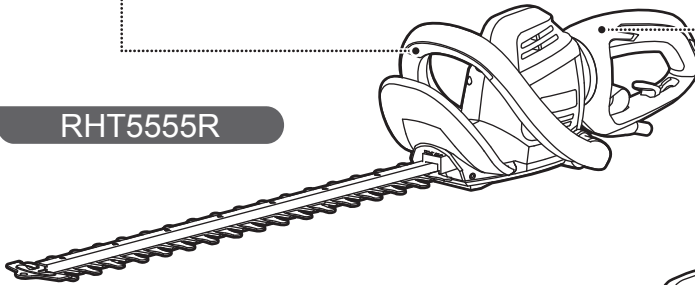

RHT6260RL

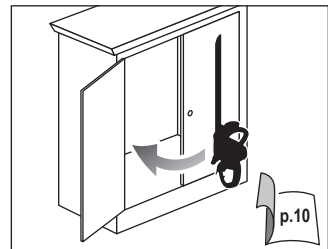
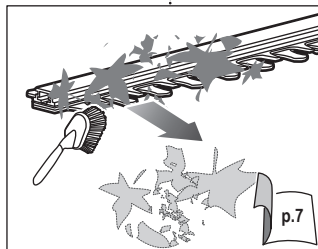
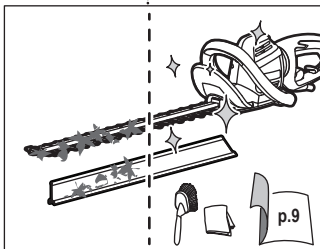
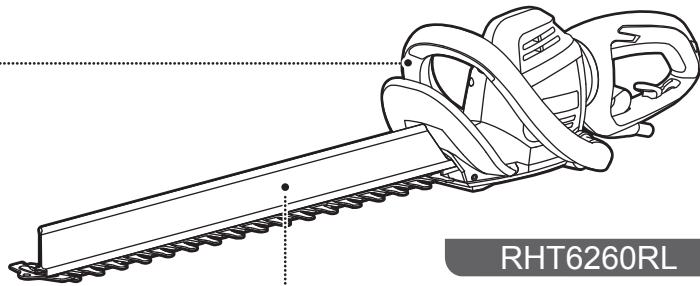



Operation

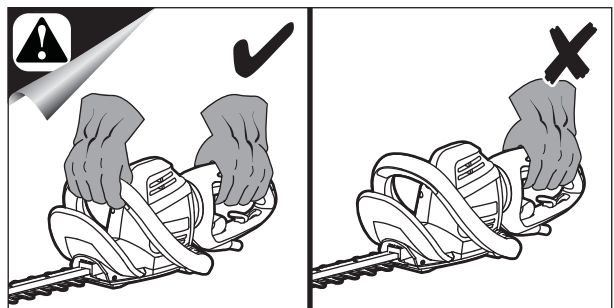
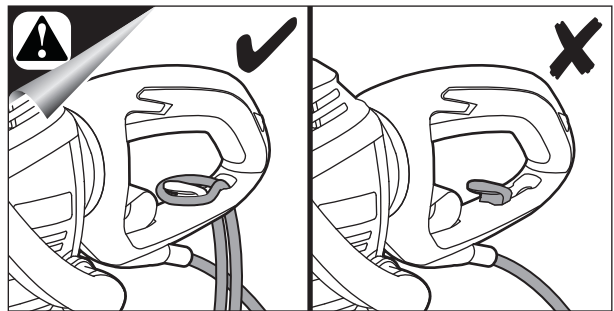
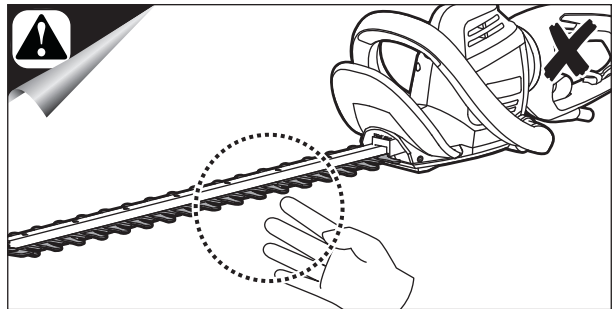
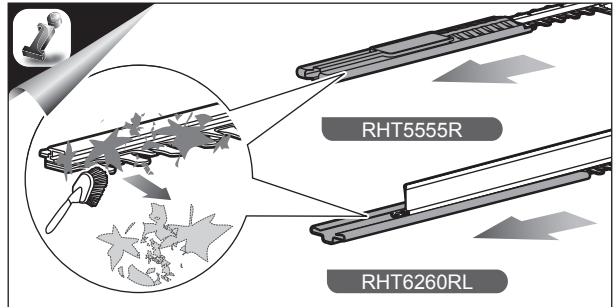



Operation

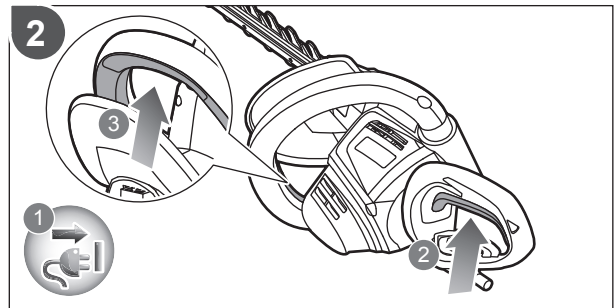
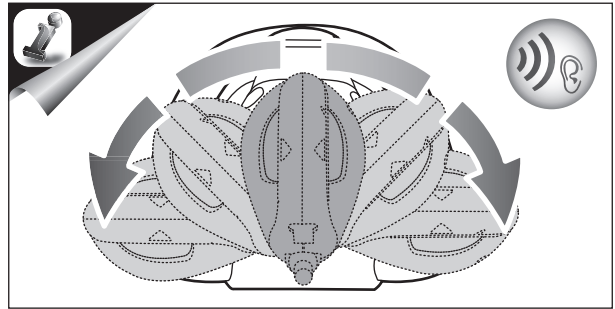
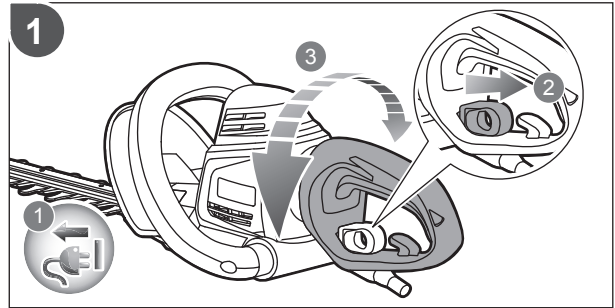
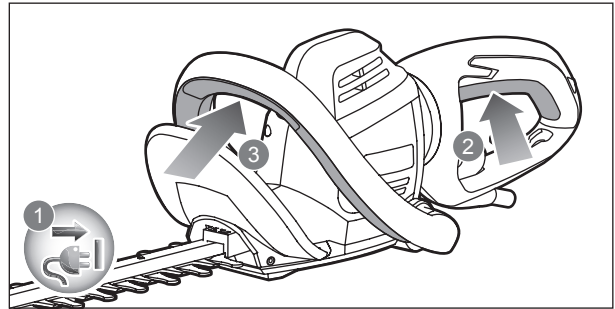
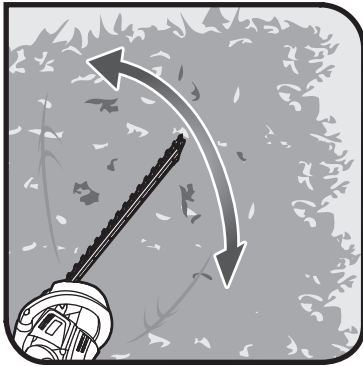



Maintenance

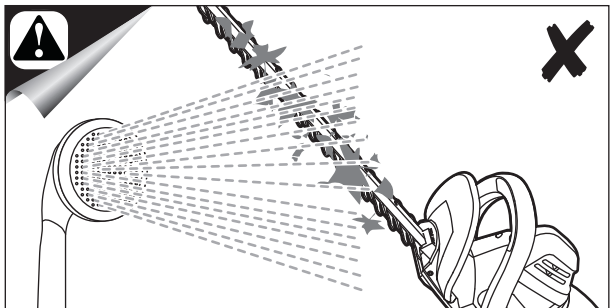
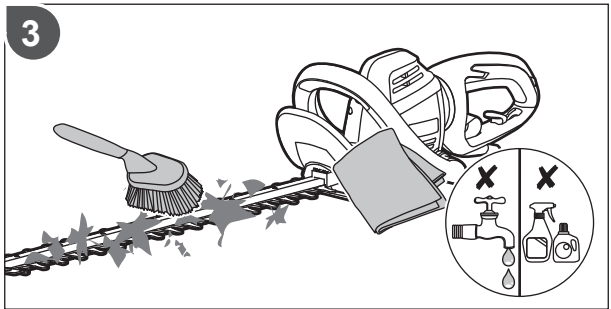
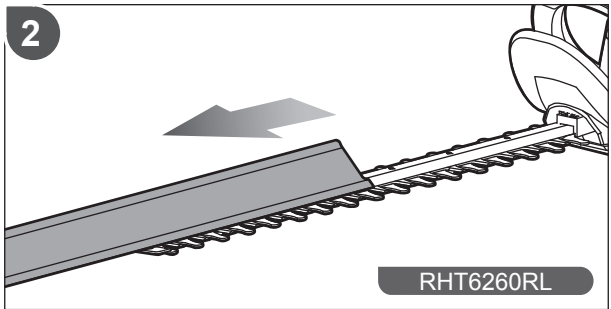
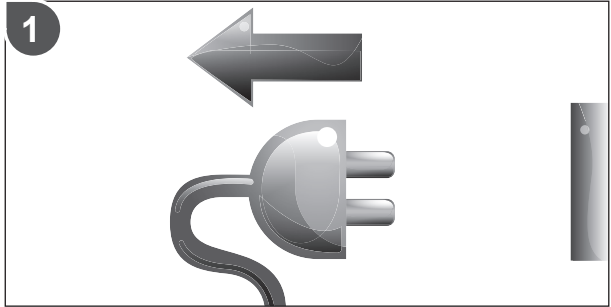
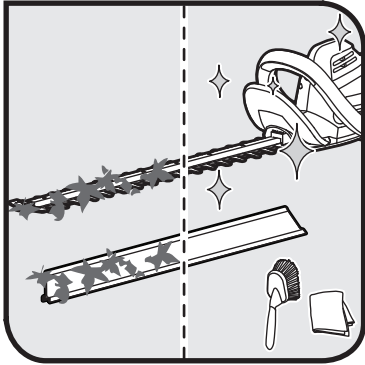



Maintenance

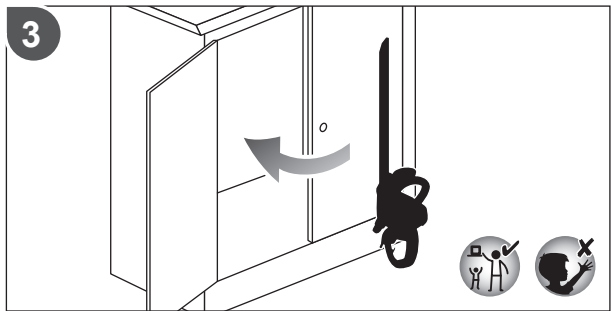
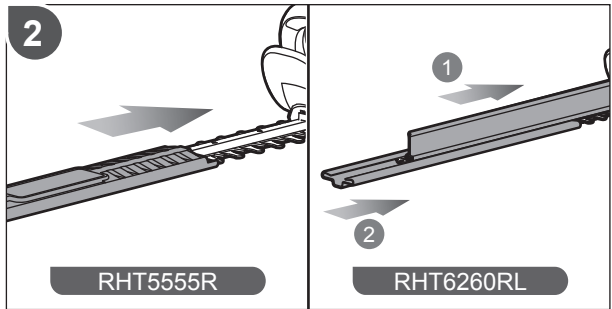
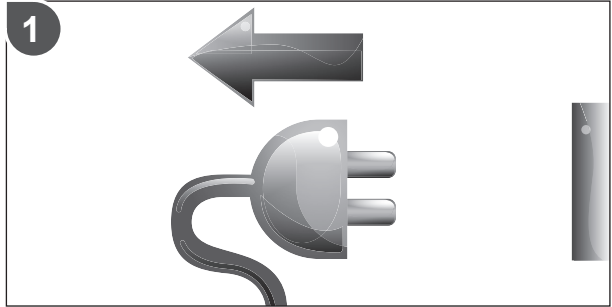

PRODUCT SPECIFICATIONS

Model	RHT5555R	RHT6260RL
Rated power	550 W	620 W
Rated voltage	220-240 V ~ 50 Hz	220-240 V ~ 50 Hz
Cutting capacity	24 mm	27 mm
Blade length	550 mm	600 mm
No-load speed	1,500 /min	1,500 /min
Brake time	< 1 s	< 1 s
Weight (without cord)	3.5 kg	3.8 kg
Vibration	3.7 m/s ² , K = 1.5 m/s ²	3.7 m/s ² , K = 1.5 m/s ²
Measured sound pressure level	L _{PK} : 84 dB(A), K _{PK} : 3.0 dB(A)	L _{PK} : 84 dB(A), K _{PK} : 3.0 dB(A)
Measured sound power level	L _{WA} : 99 dB(A), K _{WA} : 3.0 dB(A)	L _{WA} : 99 dB(A), K _{WA} : 3.0 dB(A)

VIBRATION LEVEL



WARNING

The vibration emission level given in this information sheet has been measured in accordance with a standardised test given in EN 60745 and may be used to compare one tool with another. It may be used for a preliminary assessment of exposure. The declared vibration emission level represents the main applications of the tool. However if the tool is used for different applications, with different accessories or poorly maintained, the vibration emission may differ. This may significantly increase the exposure level over the total working period.

An estimation of the level of exposure to vibration should also take into account the times when the tool is switched off or when it is running but not actually doing the job. This may significantly reduce the exposure level over the total working period. Identify additional safety measures to protect the operator from the effects of vibration such as: maintain the tool and the accessories, keep the hands warm, organisation of work patterns.



LIMITED WARRANTY

TTI warrants this outdoor product to be free of defects in material or workmanship for 24 months from the date of purchase by the original purchaser, subject to the limitations below. Please keep your invoice as proof of date of purchase.

This warranty is only applicable where the product is used for personal and non-commercial purposes. This warranty does not cover damage or liability caused by / due to misuse, abuse, accidental or intentional acts by user, improper handling, unreasonable use, negligence, failure by end user to follow operating procedures outlined in the user's manual, attempted repair by non-qualified professional, unauthorized repair, modification, or use of accessories and/or attachments not specifically recommended by authorized party.

This warranty does not cover belts, brushes, bags, bulbs or any part which ordinary wear and tear results in required replacement during warranty period. Unless specifically provided under applicable law, this warranty does not cover transportation cost or consumable items such as fuses.

This limited warranty is void if the product's original identification (trade mark, serial number) markings have been defaced, altered or removed or if product is not purchased from an authorized reseller or if product is sold AS IS and / or WITH ALL FAULTS.

Subject to all applicable local regulations, the provisions of this limited warranty are in lieu of any other written warranty, whether express or implied, written or oral, including any warranty of MERCHANTABILITY OR FITNESS FOR A PARTICULAR PURPOSE. IN NO EVENT SHALL WE BE LIABLE FOR SPECIAL, INCIDENTAL, CONSEQUENTIAL OR INCIDENTAL DAMAGES. OUR MAXIMUM LIABILITY SHALL NOT EXCEED THE ACTUAL PURCHASE PRICE PAID BY YOU FOR THE PRODUCT.

This warranty is valid only in the European Union, Australia and New Zealand. Outside these areas, please contact your authorized Ryobi dealer to determine if another warranty applies.

AUTHORISED SERVICE CENTRE

To find an authorised service centre near you, visit ryobitools.eu.



DECLARATION OF CONFORMITY

We declare under our sole responsibility that this product is in conformity with the following standards or standardised documents.

2006/42/EC, 2004/108/EC, 2000/14/EC, 2005/88/EC, 2011/65/EU

EN 55014-1:2006/+A1:2009/+A2:2011, EN 55014-2:1997/+A1:2001/+A2:2008;

EN 61000-3-2:2006/+A1:2009/+A2:2009, EN 61000-3-3:2008, EN 60745-1:2009+A11:2010,

EN 60745-2-15:2009+A1:2010

Measured sound power level 99 dB(A)

Guaranteed sound power level 102 dB(A)

Conformity assessment method to Annex V Directive 2000/14/EC.

Function: For cutting and trimming hedges

Serial number: See product rating label

Year of construction: See product rating label

Machine: **ELECTRIC HEDGE TRIMMER**

Type: **RHT5555R/RHT6260RL**

CE AUG 2012



Techtronic Industries

Techtronic Product Development Limited
24/F, CDW Building, 388 Castle Peak Road, Tsuen Wan, Hong Kong

A handwritten signature in black ink, appearing to read 'A. Eyre', is written over a horizontal line.

Andrew John Eyre (BEng, CEng, MIET)
Vice President of Engineering
Hong Kong, Aug. 17, 2012

Authorised to compile the technical file:

Klaus Hahn
Techtronic Industries (UK) Limited
Medina House, Fieldhouse Lane, Marlow, Bucks, SL7 1TB, United Kingdom

