



Register your new Bosch now:
<http://www.bosch-home.co.uk>



Sensixx'x **DA70**



BOSCH

en Operating instructions

Index	pag
General safety instructions	4
Description	7
Before using your appliance for the first time	7
Using your appliance	7
1. Filling the water tank	7
2. Setting the temperature	8
3. Ironing with steam	9
4. Shot of steam	10
5. Vertical steam	10
6. Ironing without steam	11
7. Drip protection *	12
8. Spray	12
9. "SensorSecure" function	12
10. After ironing	13
Tips to help you save energy	14
Cleaning & Maintenance	14
Multiple descaling system	15
"TextileProtect" fabric protector *	17
"StoreProtect"*	17
Trouble shooting	18
Guarantee conditions	19

**Thank you for buying the Sensixx'x
DA70 steam iron from Bosch.**

Carefully read through the operating instructions for the appliance and safeguard them for future reference.

You can download this manual from the local homepages of Bosch.

General safety instructions

- The iron must not be left unattended while it is connected to the supply mains.
- Remove the plug from the socket before filling the appliance with water or before pouring out the remaining water after use.
- The appliance must be used and placed on a stable surface.
- When placed on its stand, make sure that the surface on which the stand is placed is stable.
- The iron should not be used if it has been dropped, if there are visible signs of damage or if it is leaking water. It must be checked by an authorized Technical Service Centre before it can be used again.
- With the aim of avoiding dangerous situations, any work or repair that the appliance may need, e.g. replacing a faulty mains cable, must only be carried out by qualified personnel from an Authorised Technical Service Centre.
- This appliance can be used by children aged from 8 years and above and persons with reduced physical, sensory or mental capabilities or lack of experience and knowledge if they have been given supervision or instruction concerning use of the appliance in a safe way and understand the hazards involved. Children shall not play with the appliance. Cleaning and user maintenance shall not be made by children without supervision.
- Keep the iron and its cord out of reach of children less than 8 years of age when it is energized or cooling down.
-  CAUTION. Hot surface.
Surface is liable to get hot during use.

Important notices

- This appliance has been designed exclusively for domestic use and must not be used for industrial purposes.
- This appliance must be used only for the purposes for which it was designed, i.e. as an iron. Any other use will be considered improper and consequently dangerous.
- The manufacturer will not be held responsible for any damage arising from misuse or improper use.
- This appliance reaches high temperatures and produces steam during use, this could cause scalds or burns in case of improper use.
 - Do not touch the soleplate! Hold the iron by its handle.
 - Do not leave the supply cord hanging over the table or ironing board, to prevent the appliance from falling.
 - Do not iron clothing while it is being worn!
 - Never spray or aim the steam at persons or animals!
- Do not allow the power cable to come into contact with sharp edges or with the soleplate when it is hot.
- Never rest the iron in a horizontal position when the soleplate is hot. Rest it on its heel.
- Do not touch the appliance with wet hands when in operation.
- This appliance is to be connected and used in accordance with the information stated on its characteristics plate.

- This appliance must be connected to an earthed socket. If it is absolutely necessary to use an extension cable, make sure that it is suitable for 16A and has a socket with an earth connection.
- The appliance must never be placed directly under the tap to fill the water tank.
- Unplug the appliance from the mains supply after each use, or if a fault is suspected.
- The electrical plug must not be removed from the socket by pulling the cable.
- Never immerse the iron in water or any other fluid.
- Do not leave the appliance exposed to weather conditions (rain, sun, frost, etc.).

Advice on disposal

Our goods come in optimized packaging. This basically consists in using non-contaminating materials which should be handed over to the local waste disposal service as secondary raw materials. Your local town council can give you information about how to dispose of obsolete appliances.



This appliance is labelled in accordance with European Directive 2012/19/EU concerning used electrical and electronic appliances (waste electrical and electronic equipment – WEEE).

The guideline determines the framework for the return and recycling of used appliances as applicable throughout the EU.

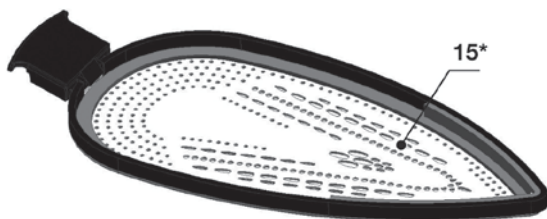
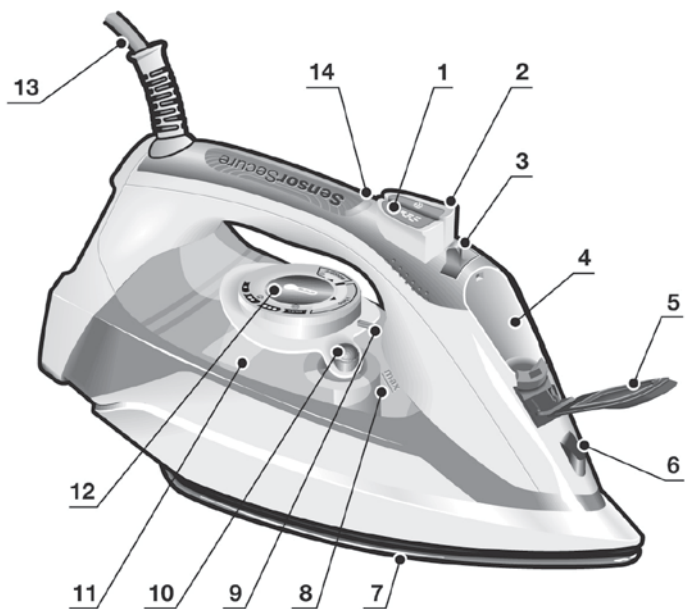

TDZ1550

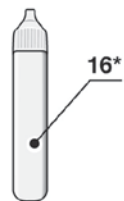

TDZ1101

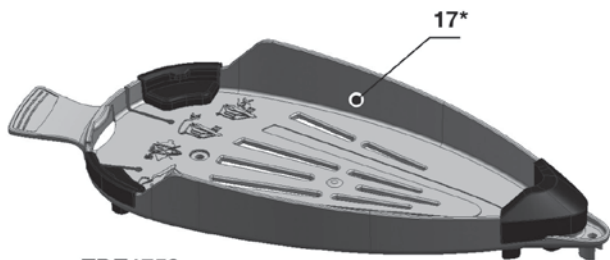

TDZ1750

Description

1. Spray button
2. Shot of steam button
3. Steam regulator
4. Water inlet
5. Water inlet lid
6. Spray nozzle
7. Soleplate
8. Level mark for maximum filling
9. Temperature index
10. "clean" button
11. Water tank
12. Temperature control
13. Power cord
14. "SensorSecure" light
15. "TextileProtect" fabric protector *
16. Descaling liquid *
17. "StoreProtect" accessory *

Before using your appliance for the first time

Remove any label or protective cover from the soleplate (7).

During its first use the iron may produce certain vapours and odours that will die away after a few minutes.

Using your appliance



1. Filling the water tank

This appliance has been designed to use normal tap water.

- The addition of other liquids, (unless recommended by Bosch) such as perfume, will damage the appliance.
- Do not use condensation water from tumble dryers, air conditioning systems or similar.

Any damage caused by the use of the aforementioned products will make the guarantee void.

⚠ Set the steam regulator (3) to the position and unplug the iron from the mains!

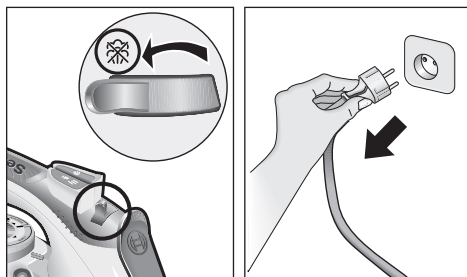

1. Open the water inlet lid (5).
2. Fill the water tank (11). **Never fill beyond the level mark for maximum filling (8).**

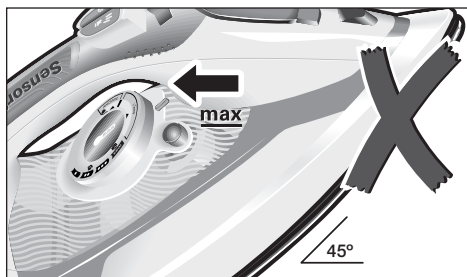
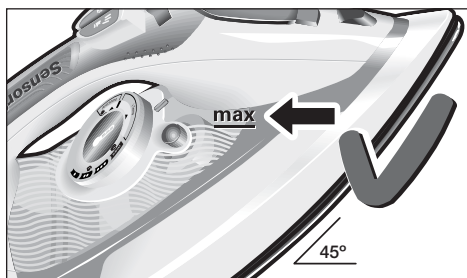
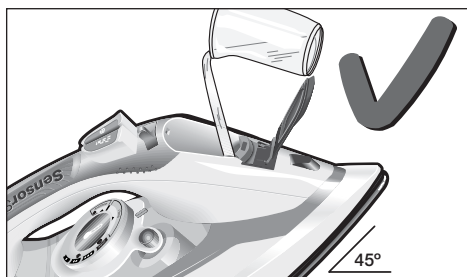

3. Close the water inlet lid.

* Model dependent

Tip: To prolong the optimum steam function, you may mix tap water with distilled water 1:1. If the tap water in your district is very hard, mix tap water with distilled water 1:2.

You can inquire about the water hardness with your local water supplier.

2. Setting the temperature

The temperature control (12) adjusts the temperature of the soleplate (7).

Set the temperature control to the corresponding position by lining it up with the temperature index (9) on the iron.

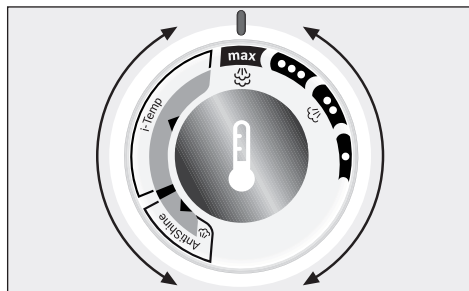

Temperature	Suitable for :
•	synthetics
••	silk – wool
•••	cotton
max	linen
i-Temp*	any type of fabric which can be ironed
AntiShine*	dark and delicate fabrics. Reduces the risk of shiny marks.

2.1 “TempOK” indicator

While the soleplate is heating up or cooling down to the selected temperature, the “TempOK” lights inside the temperature control (12) will flash. When the selected temperature is reached, the lights will stop flashing and remain lit continuously.

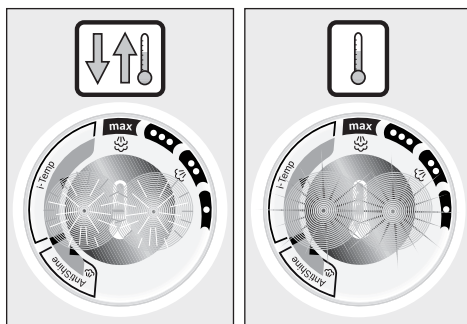

2.2 “i-Temp” function*

If this function is selected, an appropriate temperature is set which is suitable for all fabrics that can be ironed.

The “i-Temp” function prevents clothes from becoming damaged due to an unsuitable temperature being selected.

The “i-Temp” function does not apply to fabrics that cannot be ironed. Please check the garment care label for details or try ironing on a part of the fabric not visible normally.

When the “i-Temp” function is selected, the blue light inside the temperature control comes on.

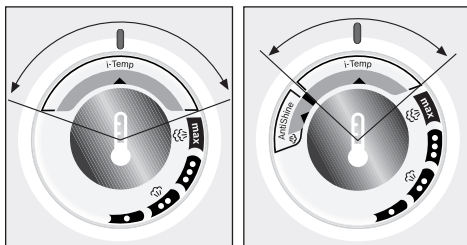



2.3 “AntiShine” function*

If this function is selected, the risk of shiny marks on the garment due to the ironing is reduced.

When the “AntiShine” function is selected, the blue light inside the temperature control comes on.

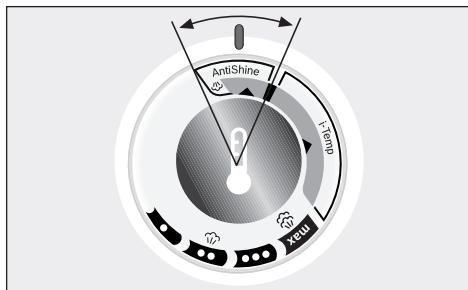

3. Ironing with steam

The steam regulator (3) is used to adjust the amount of steam produced when ironing.

Temperature control (12)	Recommended position of the steam regulator (3) *
	☀ 1 2 3 max
	☀ •eco• max
	☀ 1 2 3 max
	☀ •eco• max
i-Temp	☀ 1 2 3 max
AntiShine	☀ 1 2 3 max
	☀ •eco• max

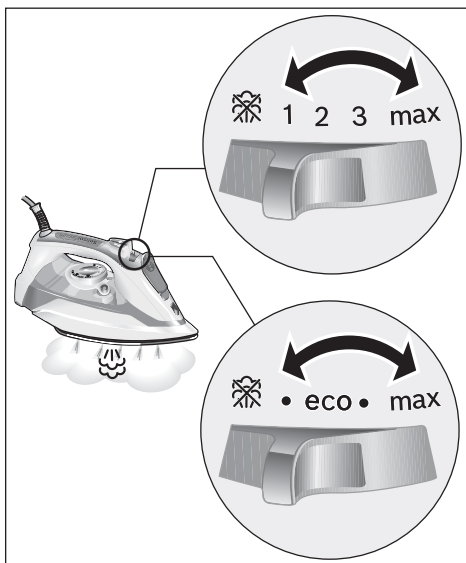
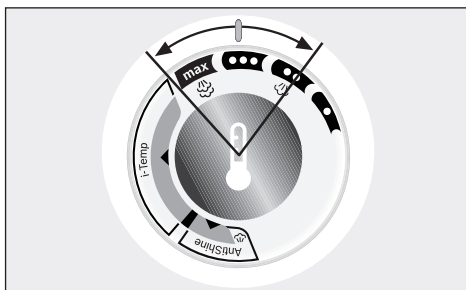

* Model dependent

 **Tip:** For better ironing results, iron the last strokes without steam to dry the garment.



4. Shot of steam

This can be used to remove stubborn wrinkles or to press in a sharp crease or pleat.

1. Set the temperature control (12) to "max".

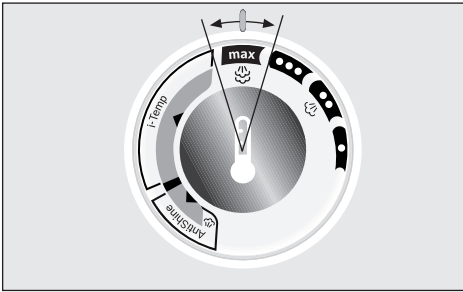

2. Press the shot of steam button  (2) repeatedly with intervals of at least 5 seconds.

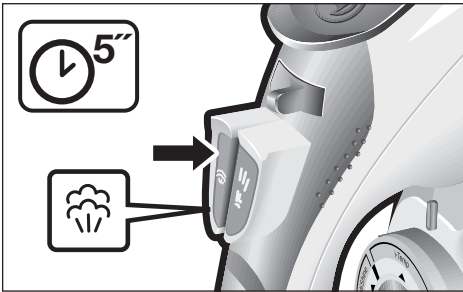

5. Vertical steam

This can be used to remove creases from hanging clothes, curtains etc.

Never direct the steam jet at garments that are being worn.

Never aim the steam at people or animals.

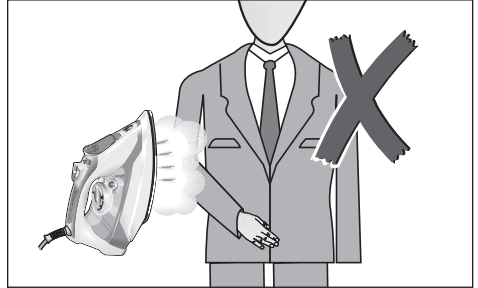

1. Set the temperature control (12) to "max".

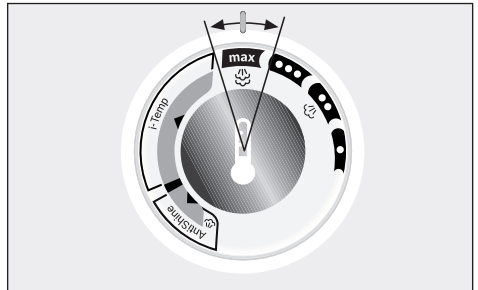

2. Hang article of clothing on a clothes hanger. Operate the iron in a vertical position at a distance of 10 cm / 4 in, and press the shot of steam button  (2) repeatedly with pauses of at least 5 seconds.

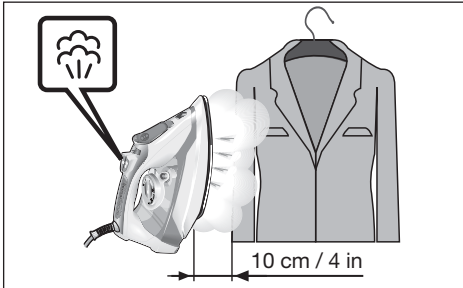

6. Ironing without steam

This enables the iron to be used for dry ironing.

1. Set steam regulator (3) to the  position.

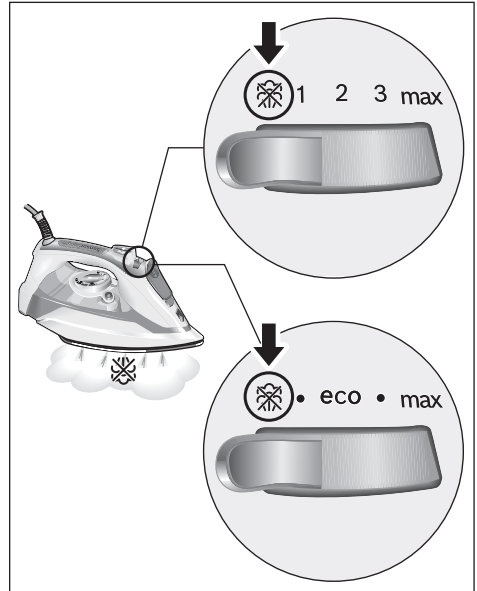

2. Select an appropriate temperature for the type of material being ironed (see "Setting the temperature" section).

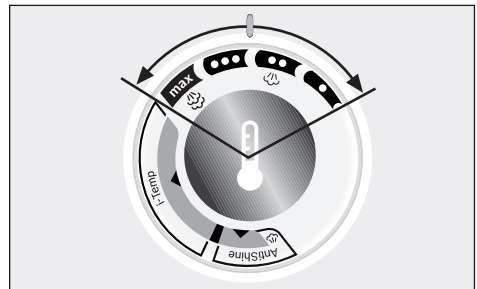



7. Drip protection *

If the temperature is set too low, the steam is automatically switched off to avoid dripping.
There may be an audible click when this occurs.

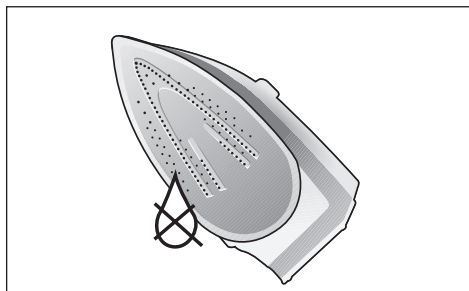

8. Spray

This can be used to remove stubborn wrinkles.

Do not use the spray function with silk.

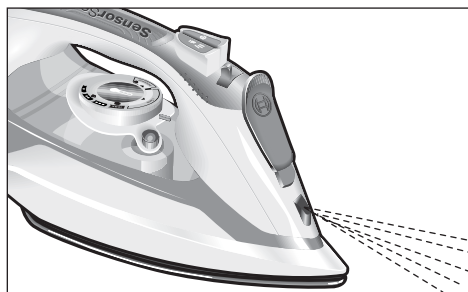
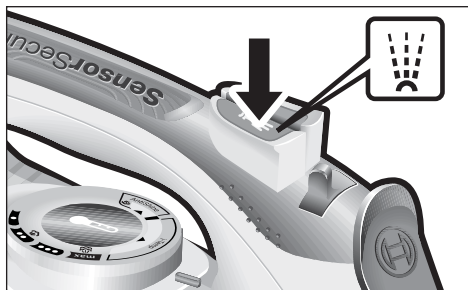

9. "SensorSecure" function

The "SensorSecure" function switches off the iron when the handle is no longer gripped, thus increasing safety and saving energy.

1. Plug in the iron.

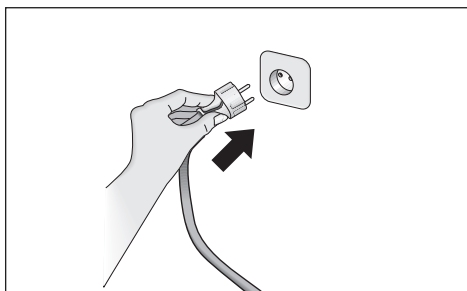

2. "SensorSecure" light (14) flashes when the handle is not gripped, and will show a continuous light when the handle is gripped.

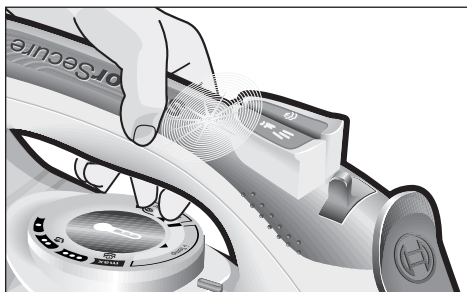
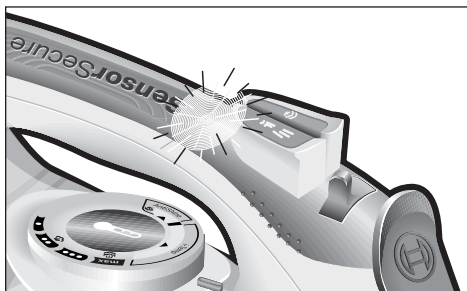

- If the iron handle is released for more than 10 seconds, the iron will stop heating automatically.
- When the handle is gripped again, the iron heating up and continuous steam generation processes will start again.

Initial heating up process: it is not necessary to grip the handle until the iron heats up to the set temperature. Once reached such temperature, the “TempOK” indicator will stop flashing and remain lit continuously.

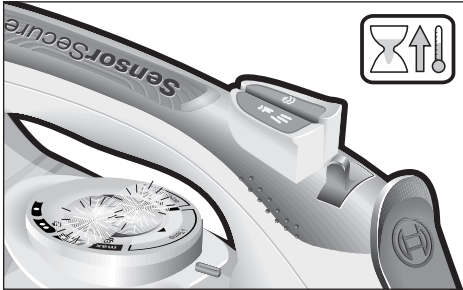

- Empty the tank. Hold the iron with the point down and shake lightly.

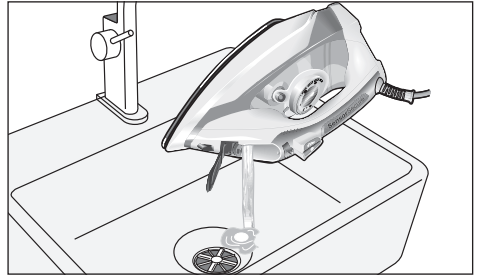

- Allow the soleplate (7) to cool down.

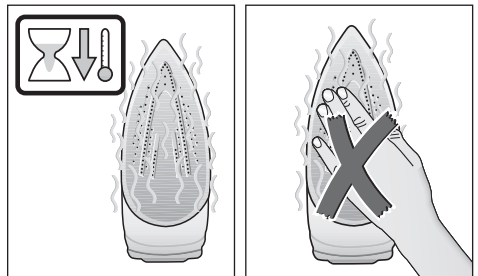

10. After ironing

- Switch the steam regulator (3) from  to “max” and back again several times (self-cleaning).

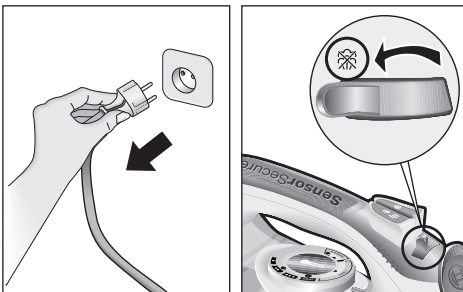

- Store the iron standing on the rear, not on the soleplate. Do not wrap the power cord (13) too tight!

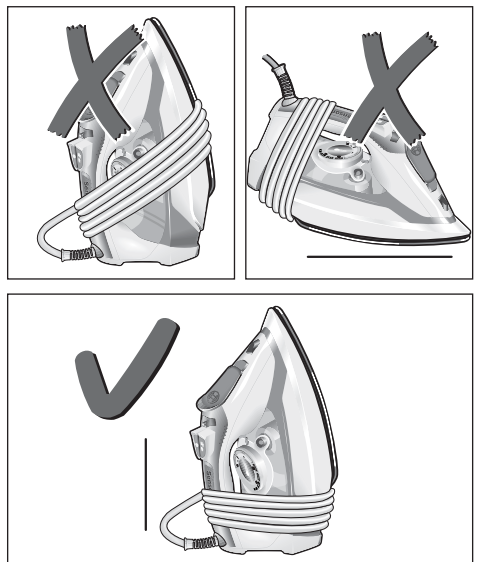



Tips to help you save energy

Steam production consumes the most energy. To help minimise the energy used, follow the advice below:

1. Start by ironing the fabrics that require the lowest ironing temperature. Check the recommended ironing temperature in the label on the garment.
2. Regulate the steam according to the selected ironing temperature, following the instructions in this manual.
3. Only use steam if necessary. If possible, use the spray function instead.
Try to iron the fabrics while they are still damp and reduce the steam setting. Steam will be generated from the fabrics rather than the iron.
If you tumble dry your fabrics before ironing them, set the tumble drier on the 'iron dry' program.
4. If the fabrics are damp enough, turn off the steam regulator (3) completely.
5. Stand the iron upright during pauses. Resting it horizontally with the steam regulator on generates wasted steam.



Cleaning & Maintenance



Attention! Risk of burns!

Always unplug the appliance from the mains supply before carrying out any cleaning or maintenance operation on it.

1. If the iron is only slightly soiled, pull out the plug and allow the soleplate (7) to cool down. Wipe the housing and the soleplate with a damp cotton cloth only.
2. If the cloth is synthetic, it may melt due to the high temperature on the soleplate, switch off the steam and rub off any residue immediately with a thickly folded, damp cotton cloth.

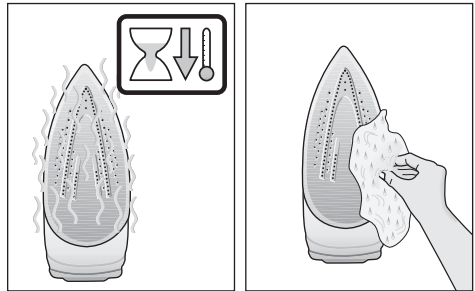

3. To keep the soleplate smooth, you should avoid hard contact with metal objects. Never use a scouring pad, or chemicals to clean the soleplate.

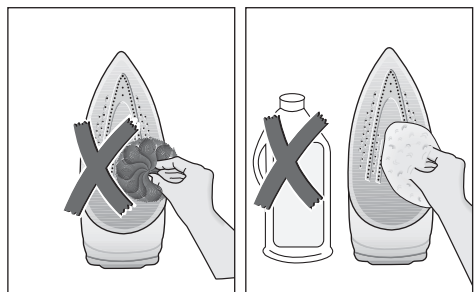



Multiple descaling system

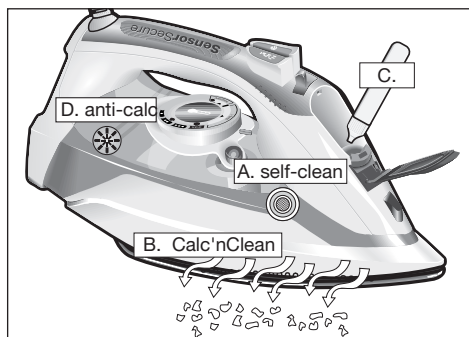

A self-clean

Each time you use the steam regulator (3), the “self-clean” system cleans the mechanism of scale deposits.

B Calc'nClean

The “Calc'nClean” function helps to remove scale particles out of the steam chamber. Use this function approximately every 2 weeks if the water in your area is very hard.

- 1 Unplug the iron from the mains socket, set the steam regulator (3) to the  position and fill the water tank (11) with water.

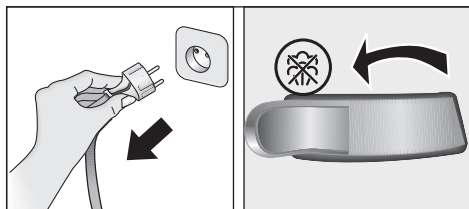

- 2 Set the temperature control (12) to the “max” position and plug in the iron.

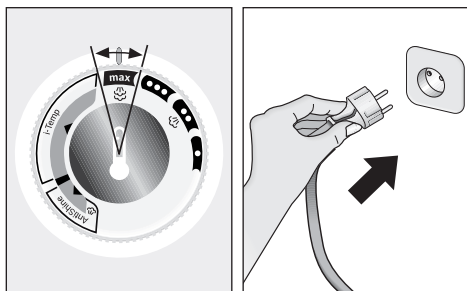

- 3 After the necessary warm-up period, the “TempOK” lights inside the temperature control (12) stop flashing. Then, unplug the iron (**very important!**).

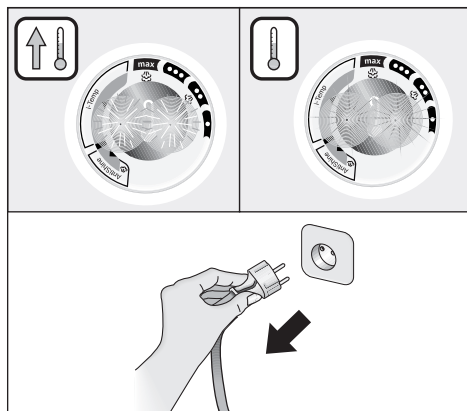

- 4 Set steam regulator to the “max” position.

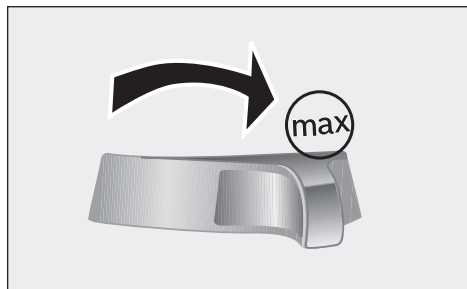

- 5 Hold the iron over a sink. Press the “clean” button (10) and shake the iron until approximately one third of the water capacity of the tank is evaporated. Boiling water and steam will come out, carrying scale or deposits that might be there.

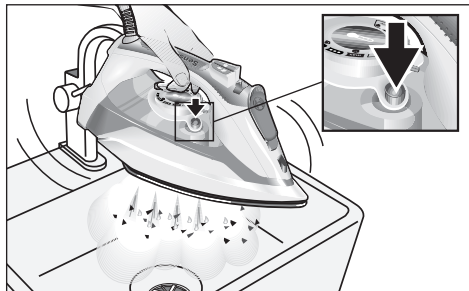

- 6 Release the “clean” button, and gently shake the iron for some seconds.

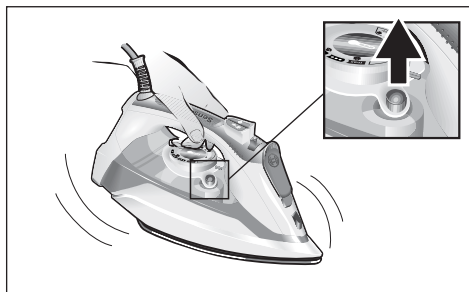

- 7 Repeat the steps 5 and 6 three times until the tank is empty.

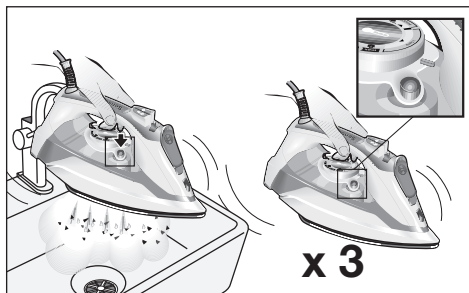

- 8 Then plug the iron in and heat it up again until the remaining water has evaporated. Push the “clean” button a few times more to clean the valve.

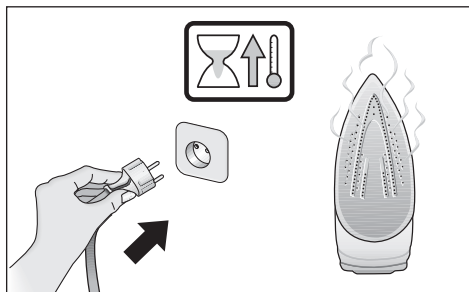

- 9 Unplug the iron and let the soleplate (7) cool down. Wipe the soleplate with a damp cotton cloth only.

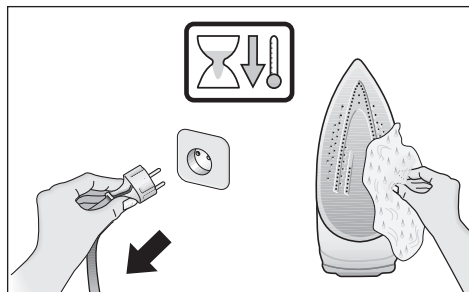

C “Calc’nClean” with descaling liquid *

For deep descaling, it is recommended to use the descaling liquid especially developed by Bosch. This procedure should be carried out every 3 months.

1. Fill the water tank (11) with tap water mixed with a measure (25 ml) of the descaling liquid (16*).
2. Then follow the procedure described above in section “Calc’nClean” (steps 2 to 9).

The descaling liquid may be purchased from our after-sales service or specialist shops.

Name of accessory: TDZ1101

D anti-calc*

The “anti-calc” cartridge has been designed to reduce the build-up of scale produced during steam ironing, helping to extend the useful life of your iron. Nevertheless the “anti-calc” cartridge cannot remove all of the scale that is produced naturally over time.



“TextileProtect” fabric protector *

The fabric protector (15*) is used for steam-ironing delicate garments at maximum temperature without damaging them.

The fabric protector may be purchased from our after-sales service or specialist shops.

Name of accessory: TDZ1550



“StoreProtect” *

The “StoreProtect” accessory (17*) enables an immediate and safe storage of the iron, even with a hot soleplate (7).

This accessory may be purchased from our after-sales service or specialist shops.

Name of accessory: TDZ1750

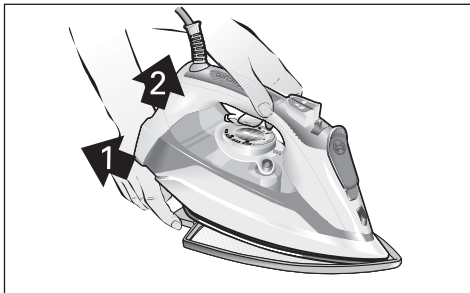
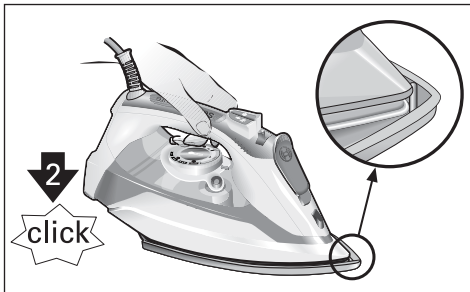

* Model dependent



Trouble shooting

Problem	Probable cause	Solution
The iron does not heat up.	<ol style="list-style-type: none">1. Temperature control (12) set to minimum.2. The "SensorSecure" system has been activated. The iron is set to stand-by.	<ol style="list-style-type: none">1. Turn to a higher position.2. Grip the handle of the iron to re-start it.
The "TempOK" lights inside the temperature control (12) flash.	<ol style="list-style-type: none">1. The soleplate (7) is heating up or cooling down to the selected temperature.	<ol style="list-style-type: none">1. This is normal and lights will stop flashing when the selected temperature is reached.
The clothes tend to stick	<ol style="list-style-type: none">1. The temperature is too high.	<ol style="list-style-type: none">1. Turn the temperature control (12) down and wait until the iron has cooled down.
Water drips out of the soleplate (7) together with steam.	<ol style="list-style-type: none">1. Temperature control (12) setting is too low.2. Steam regulator (3) is set too high in conjunction with a low temperature.3. You have pressed the shot of steam button (2) repeatedly without waiting for 5 seconds between each press.	<ol style="list-style-type: none">1. Turn the temperature control (12) to a higher setting and wait until the "TempOK" lights inside the temperature control stop flashing and remain lit continuously.2. Set the steam regulator (3) to a lower setting.3. Wait 5 seconds between each press of the shot of steam button.
Steam does not come out.	<ol style="list-style-type: none">1. Steam regulator (3) is set to  position.2. The temperature is too low. Anti-drip system is activated.	<ol style="list-style-type: none">1. Set the steam regulator to a higher position.2. Set to a higher temperature if compatible with the fabric.
Smoke comes out when connecting the iron for the first time.	<ol style="list-style-type: none">1. This may be caused by the lubrication of some of the internal parts.	<ol style="list-style-type: none">1. This is normal and will stop after a few minutes.
Excessive dripping or steaming.	<ol style="list-style-type: none">1. No proper closing of "Calc'nClean" system.	<ol style="list-style-type: none">1. Actuate a few times the "clean" button (10).
Deposits come out through the holes in the soleplate (7).	<ol style="list-style-type: none">1. Traces of lime scale are coming out of the steam chamber.	<ol style="list-style-type: none">1. Carry out a cleaning cycle (see "Calc'nClean" section).

If none of the above solves the problem, get in touch with an authorised technical service.



Guarantee conditions

The terms of the guarantee for this appliance are in accordance with that stated by our representative for the country in which it is sold.

The details of these conditions can be obtained from the retailer from whom the appliance was purchased. The purchase receipt must be presented when making any claims against the terms of this guarantee.



Customer Service

Great Britain

Bosch Customer Service

Grand Union House

Old Wolverton Road Milton Keynes

MK12 5PT

UK +44 (0)344 892 8979

IRL +353 (0)1450 2655

www.bosch-home.co.uk