



**SPEAR &  
JACKSON**

# ORIGINAL INSTRUCTION MANUAL

**34cm 1300W**

# Rotary Electric Lawnmower

**S1334ER**



**Important - Please read these instructions  
fully before starting assembly**

These instructions contain important information that will help you get the best from your mower, ensuring it is assembled correctly and safely. If you need help or have damaged or missing parts, call the Customer Helpline on 0345 605 2067

**AFTER SALES SUPPORT  
0345 605 2067**

# SPEAR & JACKSON SINCE 1760

For more than 250 years gardeners have enjoyed high quality performance and great results using Spear & Jackson tools.

Our garden power tools combine continuous innovation and the latest in manufacturing technologies with a proud heritage.

Each product is carefully designed with performance, comfort and durability firmly in mind, which has earned Spear & Jackson an enviable reputation as a maker of tools to trust.

## 3 YEARS GUARANTEE

As a testament to the quality of our products, we offer a 3 year manufacturers warranty and a comprehensive after sales service.

The warranty covers manufacturing faults, however in the event that the item has been deliberately damaged, used in a commercial environment or disassembled then the warranty will be null and void.

Please retain proof of purchase.

## 7 DAYS A WEEK TECHNICAL SUPPORT

We want you to get the best out of your products. Our easy-to-read instruction manual guides you with best practice use and maintenance tips. Please call **0345 605 2067** for technical support, we can solve around 80% of questions directly over the phone.

We hope you enjoy your product and we look forward to any feedback, as this allows us to develop even better products for the future.

# CONTENTS

|                                     |           |
|-------------------------------------|-----------|
| <b>Safety Information.....</b>      | <b>04</b> |
| Description of symbols.....         | 04        |
| General safety.....                 | 05        |
| Personal safety.....                | 08        |
| Operating safety.....               | 10        |
| Maintenance and storage safety..... | 15        |
| Intended use.....                   | 16        |
| <b>Box Content / Parts.....</b>     | <b>17</b> |
| <b>Assemble.....</b>                | <b>18</b> |
| Unpacking.....                      | 18        |
| Fix the cable retain relief .....   | 18        |
| Handle assemble .....               | 18        |
| Fix the cable .....                 | 19        |
| Assemble the grass bag .....        | 19        |
| Connection to the power supply..... | 20        |
| <b>Operate .....</b>                | <b>21</b> |
| Mowing tips.....                    | 21        |
| Switching on.....                   | 22        |
| Switching off.....                  | 22        |
| Mowing direction .....              | 23        |
| Grass bag full indicator .....      | 23        |
| <b>Maintenance .....</b>            | <b>24</b> |
| <b>Technical Data.....</b>          | <b>27</b> |
| <b>Troubleshooting.....</b>         | <b>29</b> |
| <b>Warranty.....</b>                | <b>30</b> |

# SAFETY INFORMATION

Please read these instructions fully before operating or maintaining your machine.

## DESCRIPTION OF SYMBOLS

The following warning symbols appear throughout this manual and indicate the appropriate safety measures you should take when operating and maintaining your lawnmower.



Before any use, refer to the corresponding paragraph in the present manual.



This symbol, before a safety comment, indicates a precaution, a warning or a danger. Ignoring this warning can lead to an accident for yourself or for others. To limit the risk of injury, fire, or electrocution always apply the recommendations indicated.



Wear hearing protection



Wear eye protection



Wear protective gloves



Do not expose and operate the product to rain or wet conditions.



Remove the plug from the mains immediately if cable is damaged or cut.



There is a risk that some objects could be thrown out by the shredder. Keep bystanders away.



Beware of sharp blades. Blade continue to rotate after the motor is switched off. Remove plug from mains before maintenance or if cord is damaged.



Never use mower unless the grass catcher or guard provided is in position.



Double insulation.



Keep supply flexible cord away from cutting means.



Guaranteed sound power level value in 96 dB.



The product complies with the applicable European directives and an evaluation method of conformity for these directives was done.



Waste electrical products should not be disposed of with household waste. Please recycle where facilities exist. Check with your local authority or retailer for recycling device.

# SAFETY INFORMATION

Please read these instructions fully before operating or maintaining your machine

## GENERAL SAFETY

### ! IMPORTANT!

- Keep this instruction manual in a safe place for future reference.
- Read the instructions carefully. Be familiar with the controls and the proper use of the equipment.
- Never allow children or people unfamiliar with these instructions to use this lawn mower. Local regulations can restrict the age of the operator.
- Never use the machine while people, especially children, or pets are nearby. Keep in mind that the operator or user is responsible for accidents or hazards occurring to other people or their property.
- This appliance is not intended for use by persons (including children) with reduced

physical, sensory or mental capabilities, or lack of experience and knowledge, unless they have been given supervision or instruction concerning use of the appliance by a person responsible for their safety.

- Don't use the appliance without reading the instruction sheet.
- Children should be supervised to ensure that they do not play with the appliance.

### WORK AREA SAFETY

- Inspect the area where the machine is to be used and remove all objects which can be thrown by the machine. If objects are hidden while operating stop the motor and remove them.
- Do not operate the machine in explosive atmospheres, such as in

## SAFETY INFORMATION

Please read these instructions fully before operating or maintaining your machine

the presence of flammable liquids, gases or dust. Power tools create sparks which may ignite the dust or fumes.

- Keep children and bystanders away while operating a power tool. Distractions can cause you to lose control.

### ELECTRICAL SAFETY

- The plug must match the outlet. Never modify the plug in any way. Do not use any adapter plugs with earthed (grounded) power tools. Unmodified plugs and matching outlets will reduce the risk of electric shock.
- Avoid body contact with earthed or grounded surfaces, such as pipes, radiators, ranges and refrigerators. There is an increased risk of electric shock if your body is earthed or grounded.
- Do not expose power tools to rain or wet conditions. Water entering a power tool will increase the risk of electric shock.
- Do not abuse the cord. Never use the cord for carrying, pulling or unplugging the power tool. Keep the cord away from heat, oil, sharp edges or moving parts. Damaged or entangled cords increase the risk of electric shock.
- When operating a power tool outdoors, use an extension cord suitable for outdoor use. Use of a cord suitable for outdoor use reduces the risk of electric shock.
- If operating a power tool in a damp location is unavoidable, use a residual current device (RCD) protected supply. Use of an RCD reduces the risk of electric shock. The maximum operating current of the RCD must

## SAFETY INFORMATION

Please read these instructions fully before operating or maintaining your machine

be less than 30mA.

- The voltage indicated on the rating plate must correspond to the voltage of the power source.
- Only use or replace power supply cables for this unit which correspond to the types indicated by the manufacturer. See the operating instructions for the order no. and types.
- Never touch the mains plug with wet hands.
- Do not run over, crush or pull the power supply cable or extension lead, otherwise it may be damaged. Protect the cable from heat, oil and sharp edges.
- The extension lead must have a cross section in accordance with the operating instructions and be protected against splashed water. The connection must not be in water.

### POWER TOOL USE AND CARE

- Do not force the power tool. Use the correct power tool for your application. The correct power tool will do the job better and more safely when operated at the rate for which it was designed.
- Do not use the power tool if the switch does not turn it on and off. Any power tool that cannot be controlled with the switch is dangerous and must be repaired.
- Disconnect the plug from the power source and/or the battery pack from the power tool before making any adjustments, changing accessories, or storing power tools. Such preventive safety measures reduce the risk of starting the power tool accidentally.
- Store idle power tools out of the reach of children

## SAFETY INFORMATION

Please read these instructions fully before operating or maintaining your machine

and do not allow persons unfamiliar with the power tool or these instructions to operate the power tool. Power tools are dangerous in the hands of untrained users.

- Maintain power tools. Check for misalignment or binding of moving parts, breakage of parts and any other condition that may affect the power tool's operation. If damaged, have the power tool repaired before use. Many accidents are caused by poorly maintained power tools.
- Keep cutting tools sharp and clean. Properly maintained cutting tools with sharp cutting edges are less likely to bind and are easier to control.
- Use the power tool, accessories and tool bits etc. in accordance with these instructions, taking into account the working

conditions and the work to be performed. Use of the power tool for operations different from those intended could result in a hazardous situation.

### PERSONAL SAFETY

- Stay alert, watch what you are doing and use common sense when operating the machine. Do not use the machine while you are tired or under the influence of drugs, alcohol or medication.
- Use personal protective equipment such as dust masks and non-skid safety shoes. Always wear eye protection.
- Prevent unintentional starting. Ensure the switch is in the off -position before connecting to power source and/or battery pack, picking up or carrying the tool.

## SAFETY INFORMATION

Please read these instructions fully before operating or maintaining your machine

- Do not carry the machine with your finger on the switch .
- Remove any adjusting key or wrench before turning the machine on. A wrench or a key left attached to a rotating part of the machine may result in personal injury.
- Do not overreach. Keep proper footing and balance at all times.
- Dress properly. Do not wear loose clothing or jewellery. Keep your hair, clothing and gloves away from moving parts. Loose clothes, jewellery or long hair can be caught in moving parts.
- If devices are provided for the connection of dust extraction and collection facilities, ensure these are connected and properly used. Use of dust collection can reduce dust-related hazards.
- Warning! Switch off, remove plug from mains before adjusting, cleaning or if cable is cut, damaged or entangled.
- The blades continue to rotate for a few seconds after the machine is switched off.
- The operating voltage is 230-240V~, 50Hz. If you want to use an extension cable should not be lighter than:
  - if rubber insulated, or ordinary tough rubber sheathed flexible cord
  - if polyvinyl chloride insulated, ordinary polyvinyl chloride sheathed flexible cord (code designation H05 VV-F) and the following cable dimensions should be used:
    - 1.0mm<sup>2</sup>: max. length 40m
    - 1.5 mm<sup>2</sup>: max. length 60m
    - 2.5 mm<sup>2</sup>: max. length 100m

## SAFETY INFORMATION

Please read these instructions fully before operating or maintaining your machine

### OPERATING SAFETY

- Note: If an extension cable is used it must be earthed and connected through the plug to the earth cable of your supply network in accordance with prescribed safety regulations.
- If in doubt contact a qualified electrician or call the after sales support.
- **WARNING!** Inadequate extension cables can be dangerous. Extension cable, plug and socket must be of watertight construction and intended for outdoor use.
- It is recommended for increased electrical safety to use a Residual Current Device (RCD) with a tripping current of not more than 30mA. Always check your RCD every time you use it.

### TRAINING

- Read the instructions carefully. Be familiar with the controls and the proper use of the machine.
- Never allow people unfamiliar with these instructions or children to use the product. Local regulations can restrict the age of the operator.
- Never use the machine while people, especially children, or pets are nearby. Keep in mind that the operator or user is responsible for accidents or hazards occurring to other people or their property.

### PREPARATION

- While operating the machine always wear substantial footwear and long trousers. Do not operate the machine when barefoot or wearing open sandals. Avoid wearing

## SAFETY INFORMATION

Please read these instructions fully before operating or maintaining your machine

clothing that is loose fitting or that has hanging cords or ties.

- Thoroughly inspect the area where the machine is to be used and remove all objects which can be thrown by the machine.
- Before using, always visually inspect to see that the blade, blade bolt and the blade assembly are not worn or damaged. Replace worn or damaged components in sets to preserve balance. Replace damaged or unreadable labels.
- Before use check the supply and extension cord for signs of damage or aging. If the cord becomes damaged during use, disconnect the cord from the supply immediately.

### OPERATION

- Operate the machine only in daylight or in good artificial light. Do not expose the product to rain or wet conditions. Avoid using the product in bad weather conditions especially when there is a risk of lightning.
- Never operate the machine with defective guards or shields, or without safety devices, for example deflectors and/or grass collector, in place.
- Do not put hands or feet near or under rotating parts. Keep clear of the discharge opening at all times.
- Before use check the controls and correct operation of the product.
- Before using the product or after any impact, check for signs of wear or damage and repair as necessary.

## SAFETY INFORMATION

Please read these instructions fully before operating or maintaining your machine

- Always disconnect the product from the power supply (i.e. remove the plug from the power supply or the battery pack)
  - Whenever leaving the product unattended;
  - Before clearing a blockage;
  - Before checking, cleaning or working on the product
  - After striking a foreign object;
  - Whenever the product starts vibrating abnormally.
- Always ensure that the air vents are kept clear of debris.
- Never use replacement parts or accessories not provided or recommended by the manufacturer.
- Position the cord so that it will not be caught by the cutting attachment during operation.
- Disconnect from the power supply when the cord becomes damaged or tangled.
- Do not use the product if the cord is damaged or worn.
- Warning! The cutting blade continue to move after the product is switched off.
- Keep the extension cord away from the blades at all times.
- Always be sure of your footing on slopes.
- Walk, never run.
- Mow across the face of slopes, never up and down.
- Exercise extreme caution when changing direction on slopes.
- Do not mow excessively steep slopes.
- Use extreme caution when reversing or pulling the machine towards you.
- Stop the blade(s) if the machine has to be tilted

## SAFETY INFORMATION

Please read these instructions fully before operating or maintaining your machine

- for transportation when crossing surfaces other than grass, and when transporting the machine to and from the area to be used.
- Never operate the machine with defective guards or shields, or without safety devices, for example deflectors and/or grass collector, in place.
- Switch on the motor carefully according to instructions and with feet well away from the blade(s).
- Do not tilt the machine when switching on the motor, except if the machine has to be tilted for starting. In this case, do not tilt it more than absolutely necessary and lift only the part, which is away from the operator.
- Do not start the machine when standing in front of the discharge opening.
- Do not transport the machine while the cutting blade is running. Stop the machine, and remove the key/battery pack from the machine. Make sure that all moving parts have come to a complete stop
  - whenever you leave the machine,
  - before clearing blockages or unclogging chute,
  - before checking, cleaning or working on the machine,
  - after striking a foreign object. Inspect the machine for damage and make repairs before restarting and operating the machine
- If the machine starts to vibrate abnormally (check immediately)
  - inspect for damage,
  - replace or repair any damaged parts,
  - check for and tighten any loose parts.

## SAFETY INFORMATION

Please read these instructions fully before operating or maintaining your machine

### EMERGENCY

- **WARNING!** Familiarize yourself with the use of this machine by means of this instruction manual. Memorise the safety directions and follow them to the letter. This will help to prevent risks and hazards.
- Always be alert when using the machine, so that you can recognize and handle risks early. Fast intervention can prevent serious injury and damage to property.
- Switch off and disconnect from the power supply if there is any malfunction. Have the machine checked by a qualified specialist and repaired, if necessary before you put it into operation again.

### RESIDUAL RISKS

- **WARNING!** Even if you are operating the machine in accordance with all safety requirements, potential risks of injury and damage remain. The following dangers can arise in connection with the structure and design of this machine:
  - Health defects resulting from vibration emission if the machine is being used over long periods of time or not adequately managed and properly maintained.
  - Injuries and damage to property due to broken application tools or sudden impact of hidden objects during use.
- **WARNING!** This machine produces an electromagnetic field during operation! This field may under some circumstances interfere

## SAFETY INFORMATION

Please read these instructions fully before operating or maintaining your machine

with active or passive medical implants!  
To reduce the risk of serious or fatal injury, we recommend persons with medical implants to consult their doctor and medical implant manufacturer before operating this product!

### MAINTENANCE AND STORAGE SAFETY

- Keep all nuts, bolts and screws tight to be sure the machine is in safe working condition.
- Check the grass collector frequently for wear or deterioration.
- On machines with multi blades, take care as rotating one blade can cause other blades to rotate.
- Be careful during adjustment of the machine to prevent entrapment of the fingers between

moving blades and fixed parts of the machine.

- Always allow the machine to cool down before storing.
  - When servicing the blades be aware that, even though the power source is switched off, the blades can still be moved.
  - Replace worn or damaged parts for safety. Use only genuine replacement parts and accessories.
- ### SERVICE
- Have your machine repaired by an authorized service agent. This machine is manufactured in accordance with the relevant safety regulations. To avoid danger, equipment must only be repaired by qualified technicians.
  - Only use parts and accessories made for this machine by the



## SAFETY INFORMATION

Please read these instructions fully before operating or maintaining your machine

manufacturer. Failure to do so can result in personal injury.

## INTENDED USE

This lawnmower is designed for domestic use only:

- This electric lawnmower is intended for mowing lawns in domestic and hobby gardens.
- This product is not to be used in wet weather conditions and may not be used to mow wet or unusually high grass, e. g. pasture grass or for shredding leaves.
- This product is intended for private domestic use only, not for any commercial trade use. It must not be used for any purposes other than those described. Any use of the machine that deviates from its intended use and is not included in these.

## BOX CONTENTS

### PARTS

- |   |   |    |   |
|---|---|----|---|
| 1 | Switch box                                | 8  | Wheel                                     |
| 2 | Switch bar                                | 9  | Height adjusting handle                   |
| 3 | Upper handle                              | 10 | Deck                                      |
| 4 | Lower handle                              | 11 | Power cable                               |
| 5 | Quick release lock for upper handle 2 pcs | 12 | Quick release lock for lower handle 2 pcs |
| 6 | Full grass indicator                      | 13 | Roller                                    |
| 7 | Grass bag                                 | 14 | Cable retain relief                       |
|   |   | 15 | Grass bag handle                          |

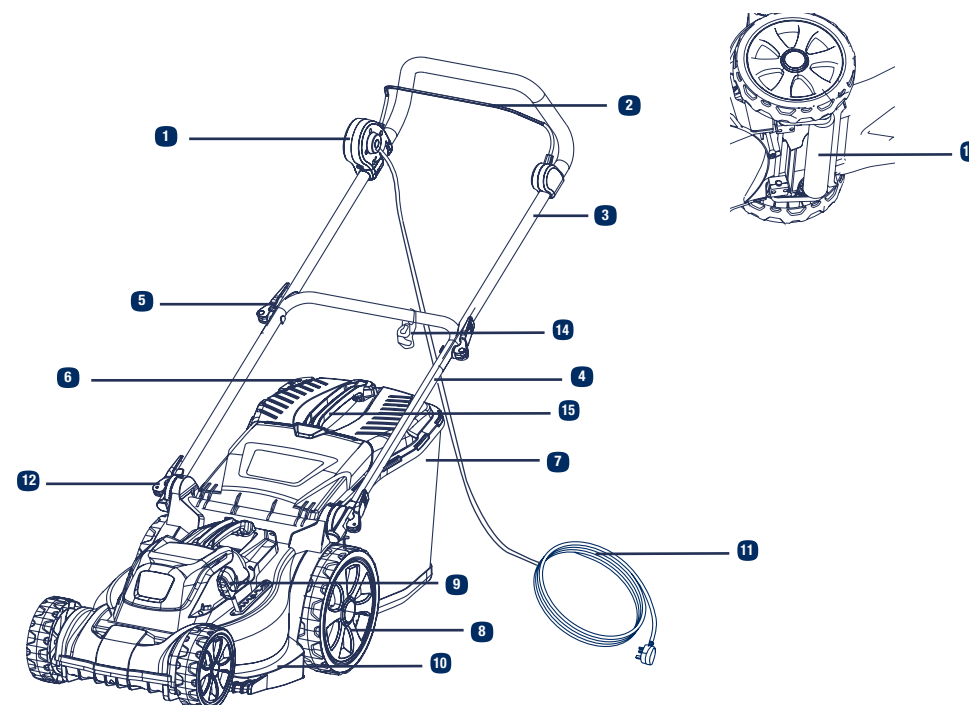

If there are any parts missing, please call the customer helpline on **0345 605 2067**

# ASSEMBLE

## 1 Unpacking

- i. Unpack all parts and lay them on a flat, stable surface.
- ii. Remove all packing materials and shipping devices if applicable.
- iii. Make sure the delivery contents are complete and free of any damage. If you find that parts are missing or show damage do not use the product but contact the aftersales service within 28 days of purchase. Using an incomplete or damaged product represents a hazard to people and property.
- iv. Ensure that you have all the accessories and tools needed for assembly and operation. This also includes suitable personal protective equipment.

## 2 Fix the cable retain relief

- i. Lead the lower handle through the hole in the cable retain relief, and hook on it.

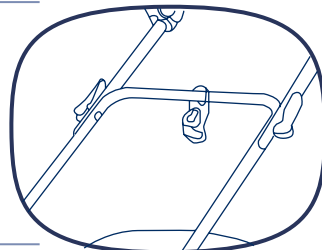

## 3 Handle assemble

- i. Slide the two fixing blocks to the end of lower handle.
- ii. Insert the quick release lock into the tube and handle seat. Screw the bolt in and clamp it to fix the lower handle.
- iii. Fit the upper handle and lower handle together with quick release lock system. You can rotate release lock to adjust the tightness of lock.

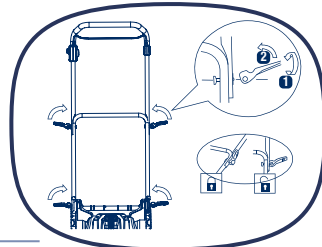
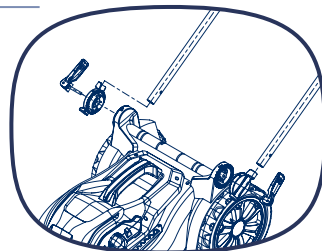

# ASSEMBLE

## 4 Fix the cable

- i. Ensure that the cables clips supplied are used to fix the cable to the handle.

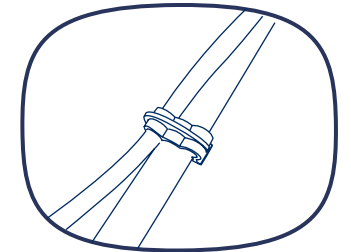

## 5 Assemble the grass bag

- i. Insert the grass bag handle in the upper cover of grass bag.

When assembling the handle, please insert the rear part of the handle (until it clicks) first then click the front part of the handle into place.

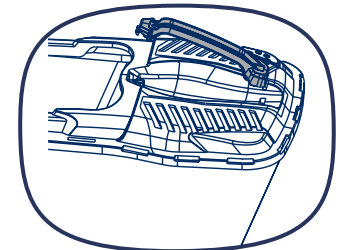

- ii. Place the metal frame inside the grass collection bag. Make sure that these clips are fully secured to the metal frame.

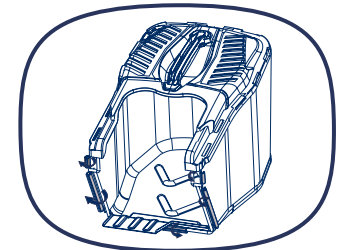

- iii. Lift up the rear flap before assemble the grass bag. Hang the collection bag on the mower.

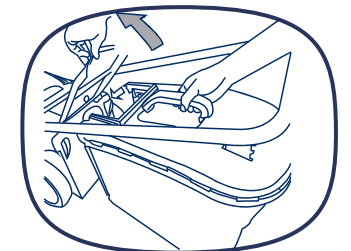

# ASSEMBLE

## 6 Connection to the power supply

- i. Double the extension cord, about a foot from the end. Hook the loop over the cord strain.

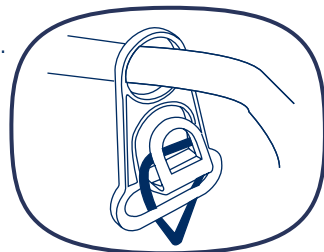

- ii. Connect the plug to the main socket.

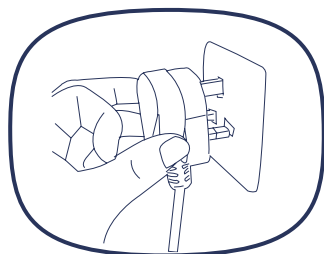

# OPERATE

## MOWING TIPS

- Verify that the lawn is free of stones, sticks, wires, and other objects that could damage the lawn mower.
- When cutting thick grass, reduce walking speed in order to allow for a more effective cut and a proper discharge of the clippings.
- Never cut off more than one-third of the total length of the grass for a healthy lawn. If it is roughly 6cm long, the grass should not be shorter than 4cm once mowed. If the grass is higher, you should gradually cut it down to the desired length so as not to damage the grass.
- Do not cut wet grass because it tends to stick to the underbody of the lawn mower, preventing the proper discharge of grass clippings.

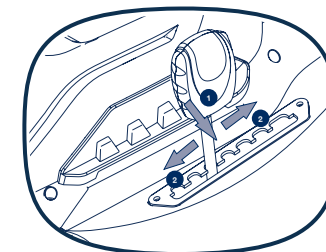

| Cutting position | Cutting height |
|------------------|----------------|
| 1                | 25mm           |
| 2                | 29mm           |
| 3                | 40mm           |
| 4                | 50mm           |
| 5                | 59mm           |
| 6                | 66mm           |
| 7                | 75mm           |

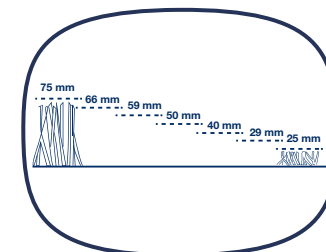

## IMPORTANT NOTE

This mower is fitted with a motor thermal protection device to protect the motor when it (or the blade) shuts down (or block) during operation, for whatever reasons .

Procedure to follow when the protection device is triggered:

- release the switch lever
- disconnect the extension lead
- check what caused the blade to suddenly come to a halt(clean the cutting chassis)
- allow the machine to cool down in a cool environment around 5 minutes

# OPERATE

## Switching on

- i. Press the button (1).
- ii. Pull the switch bar (2) towards the handle and hold in position.

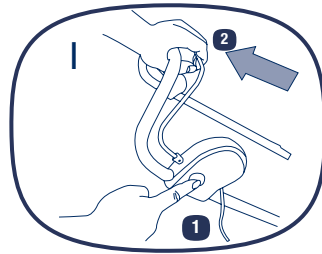

## Switching off

Release the switch bar.

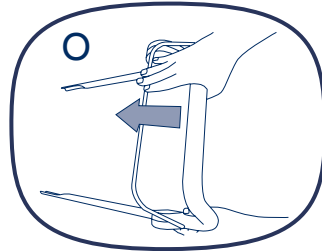

# OPERATE

## Mowing direction

- i. When you begin to mow please follow the arrow, avoiding twisting the power cord or the risk of cutting the cord.

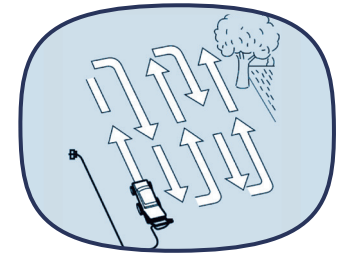

## Grass bag full indicator

- i. If the collection bag is empty or it is not full with grass, the grass full indicator will open.

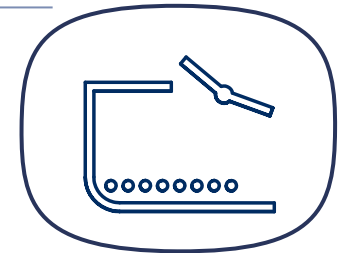

- ii. If the collection bag is full with grass the grass full indicator will close.

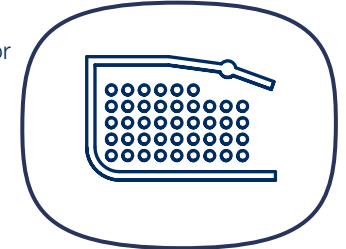

# MAINTENANCE



## WARNING!



Always switch the product off, disconnect it from the power supply and let the product cool down before performing inspection, maintenance and cleaning work!

- i. Keep the underbody and cutting blade clean and free of debris. Remove clippings from the discharge chute.
- ii. Check all nuts and bolts periodically for tightness before operation. After prolonged use, especially in sandy soil conditions, the cutting blade will become worn and lose some of its original shape. The cutting efficiency will be reduced and the cutting blade should be replaced.
- iii. Lubricate the cutting blade after each use to prolong the life span of the cutting blade and product. Apply light machine oil along the edge of the cutting blade.

## Replacing the cutting blade

Keep the cutting blade sharp to ensure a good cutting performance. Replace a worn or damaged cutting blade with a new one of the same type or have it sharpened by a qualified specialist.

- i. Loosen the bolt anticlockwise using a suitable wrench and remove it together with the blade.
- ii. Replace the blade with a new one of the same type.
- iii. Reattach the blade onto the spindle, pay attention to correct alignment. Tighten the bolt clockwise with 16 Nm min, 20 Nm max. to ensure safe operation of your product. temperature is between 10 and 30°C.

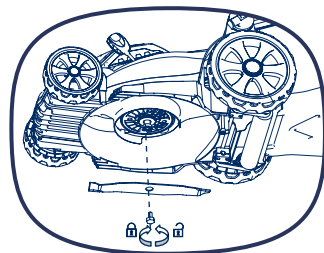

**NOTE: Replace this cutting device after 50 hours mowing or 2 years whichever is sooner regardless of condition. If the cutting device is cracked or damaged, immediately replace it with a new one.**

# MAINTENANCE

## Repair

This product does not contain any parts that can be repaired by the consumer. Contact an authorised service centre or a similarly qualified person to have it checked and repaired.

## Power cord

If the power cord is damaged, it must be replaced by the manufacturer.

## Storage

- Switch the product off and disconnect from power supply.
- Clean the product as described above.
- To reduce storage space, the upper handle can be folded down, unscrew the wing nuts by approximately 6 revolutions.
- We recommend using the original package for adjust formatting the product with a suitable cloth or enclosure to protect it against dust.

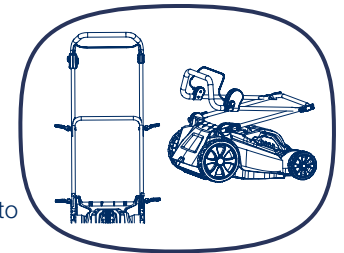

## Transportation

- Switch the product off and disconnect from power supply.
- Protect the product from any heavy impact or strong vibrations which may occur during transportation in vehicles.
- Secure the product to prevent it from slipping or falling over.

# MAINTENANCE

## Recycling and disposal

- The product comes in a package that protects it against damage during shipping. Keep the packaging until you are sure that all parts have been delivered and the product is functioning properly. Recycle the packaging afterwards.
- Old products are potentially recyclable and do not, therefore, belong in your household rubbish. You are requested to assist us and our contribution to saving resources and protecting the environment by handing in this product at an equipped collection centre (if there is one available).



# TECHNICAL DATA

| Model                | S1334ER                |
|----------------------|------------------------|
| Input voltage rating | 230-240~, 50Hz         |
| Input power          | 1300W                  |
| No load speed        | 3500 /min              |
| Cutting width        | 34cm                   |
| Cutting height       | 25-75mm, 7 adjustments |
| Grass bag capability | 35L                    |
| Safety class         | class II               |
| Weight               | 16kg                   |
| Waterproof degree    | IPX4                   |

| PART NUMBER | ACCESSORIES         |
|-------------|---------------------|
| 1491009     | Grass bag           |
| 1413601     | Quick release knobs |
| 1432209     | Blade               |

## Sound values

Sound pressure level  $L_{pA}$ : 84.60dB(A)

Sound power level  $L_{WA}$ : 93.50dB(A)

Uncertainty K: 2.86dB(A)

Guaranteed sound power level  $L_{WA}$ : 96dB(A)

## Vibration values

Hand arm vibration  $a_h$ : <2.5m/s<sup>2</sup> (0.99m/s<sup>2</sup>)

Uncertainty K: 1.5m/s<sup>2</sup>

## TECHNICAL DATA

The sound values have been determined according to noise test code given in EN 60335-2-77, using the basic standards EN ISO 11201 and EN ISO 3744.

The sound intensity level for the operator may exceed 80 dB(A) and ear protection measures are necessary.

The declared vibration value has been measured in accordance with a standard test method (according to EN 60335-2-77) and may be used for comparing one product with another. The declared vibration value may also be used in a preliminary assessment of exposure.



**WARNING!** Depending on the actual use of the product the vibration values can differ from the declared total! Adopt proper measures to protect yourself against vibration exposures! Take the whole work process including times the product is running under no load or switched off into consideration!

Proper measures include among others regular maintenance and care of the product and cutting attachments, keeping hands warm, periodical breaks and proper planning of work processes!

## TROUBLESHOOTING

Suspected malfunctions are often due to causes that the user can fix themselves. Therefore, check the product using this section. In most cases the problem can be solved quickly.



**WARNING!** Only perform the steps described within these instructions! All further inspection, maintenance and repair work must be performed by an authorised service centre or a similarly qualified specialist if you cannot solve the problem yourself!

Gloves and appropriate protective clothing must be worn when performing these instructions.

| Problem                                     | Possible cause  | Solution  |
|---|---|---|
| 1. Motor does not run                       | <ul style="list-style-type: none"> <li>Not connected to power supply</li> <li>Grass is too long, wrapped around the blade.</li> <li>Mower housing clogged with grass and debris.</li> <li>Cutting too much grass</li> </ul>                       | <ul style="list-style-type: none"> <li>Connect to power supply</li> <li>Start on short grass or on an area which has already been mown</li> <li>Clean discharge channel/housing (the mowing blade must rotate freely)</li> <li>Correct the cutting height.</li> </ul>             |
| 2. Motor power drops                        | <ul style="list-style-type: none"> <li>Cutting too much grass</li> <li>Mower housing clogged with grass and debris.</li> <li>Cutting blade worn or rusty.</li> <li>The grass box is full</li> </ul>   | <ul style="list-style-type: none"> <li>Correct the cutting height</li> <li>Clean discharge channel/housing (the mowing blade must rotate freely)</li> <li>Replace the mower cutter blade -see maintenance section</li> <li>Ensure the grass box is empty.</li> </ul>              |
| 3. Grass catcher is not filled sufficiently | <ul style="list-style-type: none"> <li>Cutting too much grass</li> <li>The lawn is too wet</li> <li>Cutting blade worn or rusty.</li> <li>Air vents on the grass box are blocked</li> <li>Mower housing clogged with grass and debris.</li> </ul> | <ul style="list-style-type: none"> <li>Correct the cutting height</li> <li>Allow the lawn to dry</li> <li>Replace the mower cutter blade - see maintenance section</li> <li>Clean the vents on the grass collection box</li> <li>Clean the discharge channel / housing</li> </ul> |

# WARRANTY

If your device develops a fault, please don't hesitate to contact our customer service department on 0345 605 2067, the majority of problems can be solved directly on the phone.

1. These warranty terms cover additional warranty rights and do not affect your statutory warranty rights. All our products are covered by a 3 year manufacturer warranty.
2. Claims must be accompanied by proof of purchase. This must be in the form of a Sales receipt or bank statement and must show that the product has been purchased within the warranty period as described under point 1, from the retailer that it was originally bought from. Please keep your receipt safe or staple it to the back of this manual for future reference.
3. Our warranty covers problems caused by material or manufacturing defects, and will result in the repair of these defects or replacement of the device with a like for like or similar article.
4. Our devices have not been designed for commercial, trade or industrial applications, any signs of use of the equipment in these application or equivalent activities, invalidates the warranty.
5. The following are also excluded from our warranty:
  - A. Faults due to accidents, customer misuse or unauthorized repairs
  - B. Consumable Parts such as blades, quick release locks, extension cables, wheels, grass bags and other accessories that are compatible with the product.
  - C. Failure due to lack of routine maintenance.
  - D. Failure as a result of not using the equipment in accordance with the manual and safety instructions
  - E. The adjustment of cables, drives belts or switch box.

Warranty claims should be submitted before the end of the warranty period, see point 1, but a paid service exists for repairs commissioned after this period. The original warranty period remains applicable to the device even if repairs are carried out or parts are replaced. In such cases, the work performed or parts fitted will not result in an extension of the warranty period, and no new warranty will become active for the work performed or parts fitted.

If you have any problems or questions concerning your garden power tool, please contact our after sales service at 0345 605 2067.