

Jasmin 4 Seater Table

Assembly Instructions - Please keep for future reference

276/8504

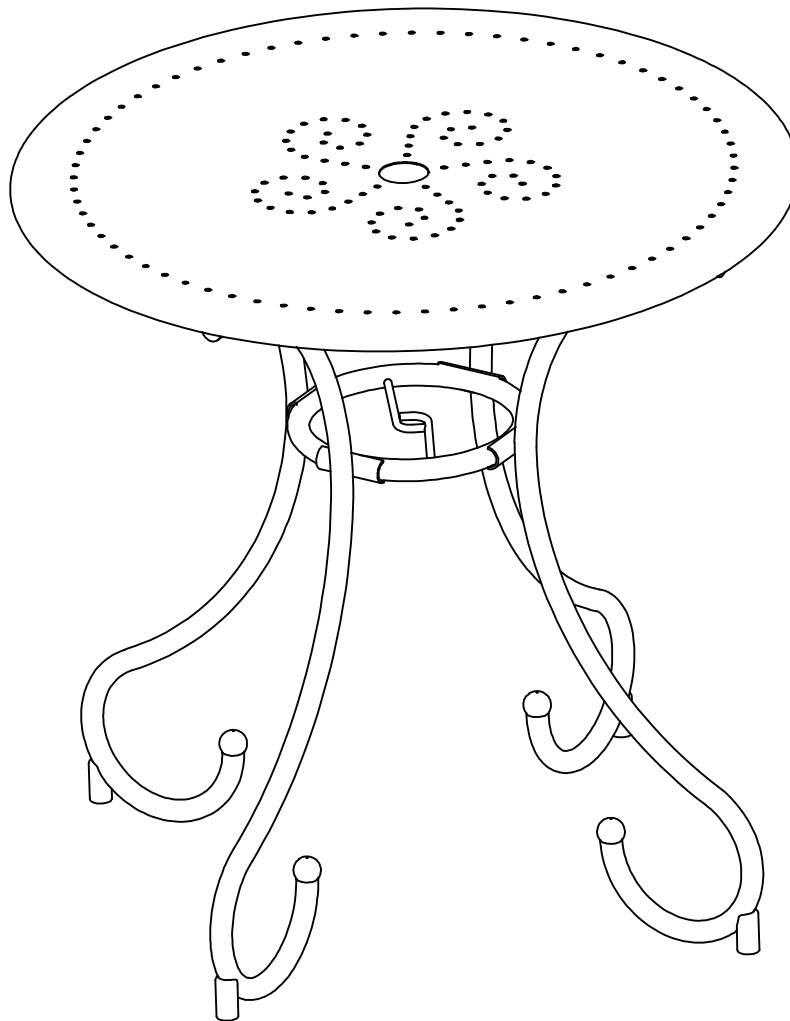

Dimensions

Diameter-95cm

Height-72.5cm

Important – Please read these instructions fully before starting assembly

If you need help or have damaged or missing parts, call the Customer Helpline: 03456 400800



Safety and Care Advice

Important – Please read these instructions fully before starting assembly

- Check you have all the components and tools listed on page 2.
- Remove all fittings from the plastic bags and separate them into their groups.
- Keep children and animals away from the work area, small parts could choke if swallowed.
- Make sure you have enough space to layout the parts before starting.

- Do not stand or put weight on the product during assembly, this could cause damage.
- Assemble the item as close to its final position (in the same room) as possible.
- Assemble on a soft level surface to avoid damaging the table or your floor.
- Parts of the assembly will be easier with 2 people.



- To reduce the likelihood of damaging your product please ensure that your power drill is set on a low torque setting.

Care and maintenance

- This product has been designed for careful domestic outdoor use.
- Only clean using a damp cloth and mild detergent, do not use bleach or abrasive cleaners.
- Make sure each screw matches the corresponding figure to ensure correct assembly.
- From time to time check that there are no loose screws on this table.
- Do not fully tighten all screws until assembly is complete.
- This product should not be discarded with household waste. Take to your local authority waste disposal centre.
- When using a parasol with this table, always use a parasol base.
- When moving the table remove the parasol and lift the table. Do not drag. We recommend the use of furniture covers when not in use. We recommend that the table is stored in a dry and secure area, during off season periods.

Components - Parts

Please check you have all the parts listed below

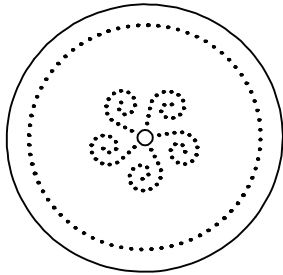

1 Table top x1

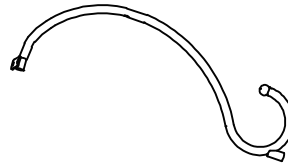

2 Table legs x4

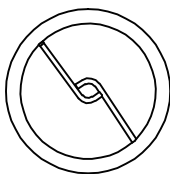







3 Small top x1

Components - Fittings

Please check you have all the fittings listed below

Note: The quantities below are the correct amount to complete the assembly.

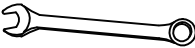
<p>A  M6*12 Screw x 8</p>	<p>B  M6*32 Screw x8</p>	<p>C  Metal washer x 24</p>
<p>D  Plastic cap x 4</p>	<p>E  Nut x8</p>	<p>F  Plastic cap x8</p>
<p>G  Allen key x1</p>	<p>H  Spanner x1</p>	

Ruler - Use this ruler to help correctly identify the screws

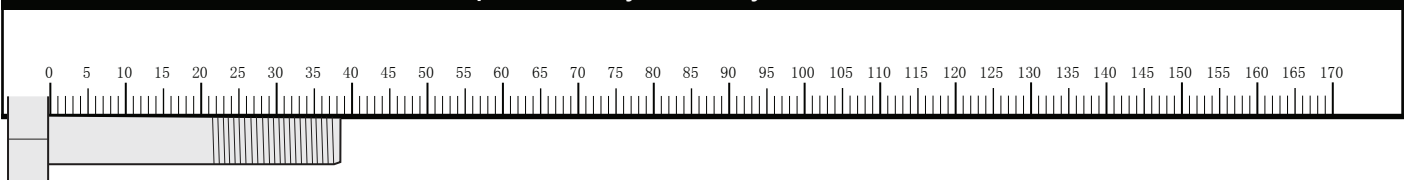

Assembly Instructions

Step 1

Assembly frame

Assembly should be carried out by two people.

Use allen Key **G**, screws **B**, metal washer **C**, nuts **E** and spanner **H** to fix the small top **3** to **4** table legs **2**.



Important: Do not fully tighten all screws until assembly is complete.

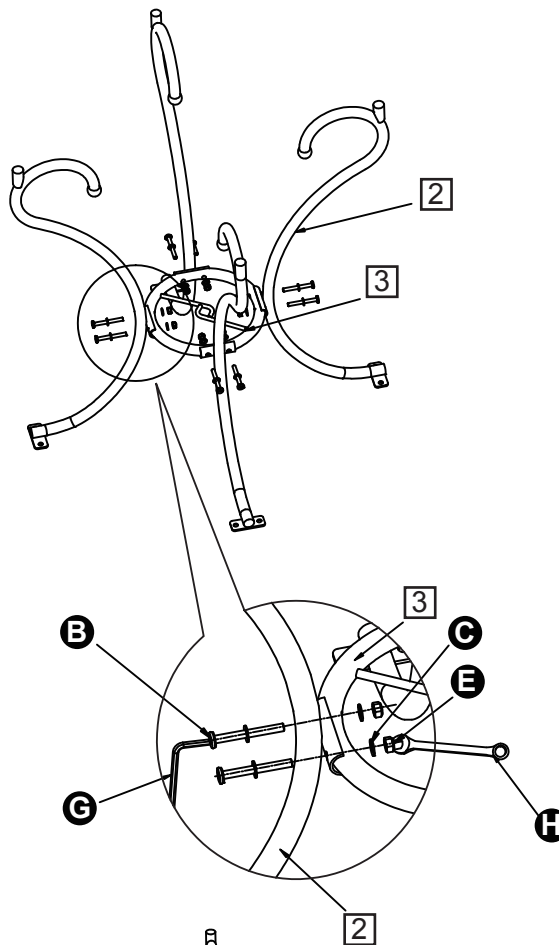

Step 2

Use allen key **G**, metal washer **C** and screws **A** to fix the table legs **2** to table top **1**.

Tighten all the screws

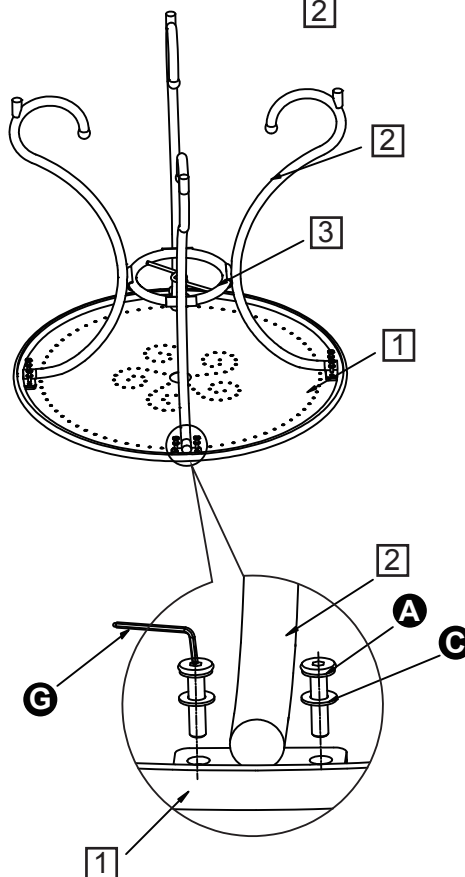

Assembly Instructions

Step 3

Seal all the screws **A** & **B** and nuts **E** with plastic caps **D** & **F**.

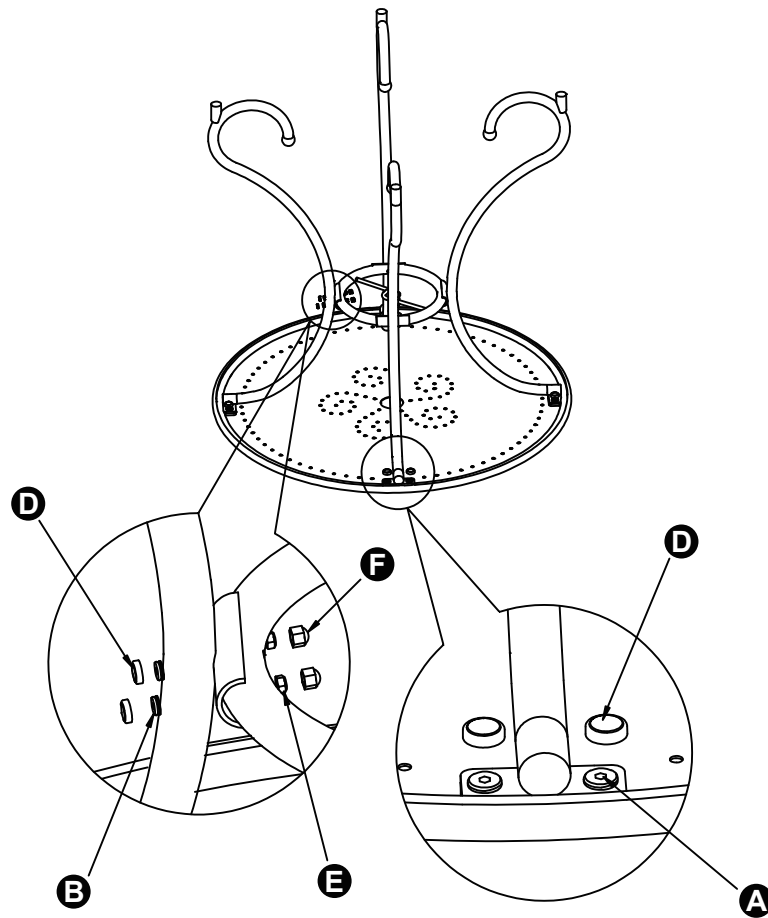

Step 4

Turn the table to its upright position.

Warning:

In order to use this table with a parasol, remove the plastic cap from the center of the table. Always use the parasol base

Assembly is complete.

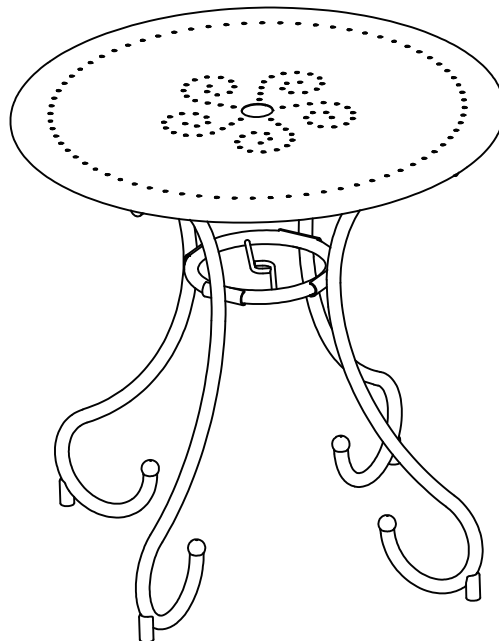

If you need help or have damaged or missing parts, call the **Customer Helpline: 03456 400800**
Argos Limited
489-499 Avebury Boulevard Saxon Gate West Central Milton Keynes Bucks, MK9 2NW