

# Hygena wall cabinet

Assembly Instructions - please keep for future reference

296/7378

**hygena**

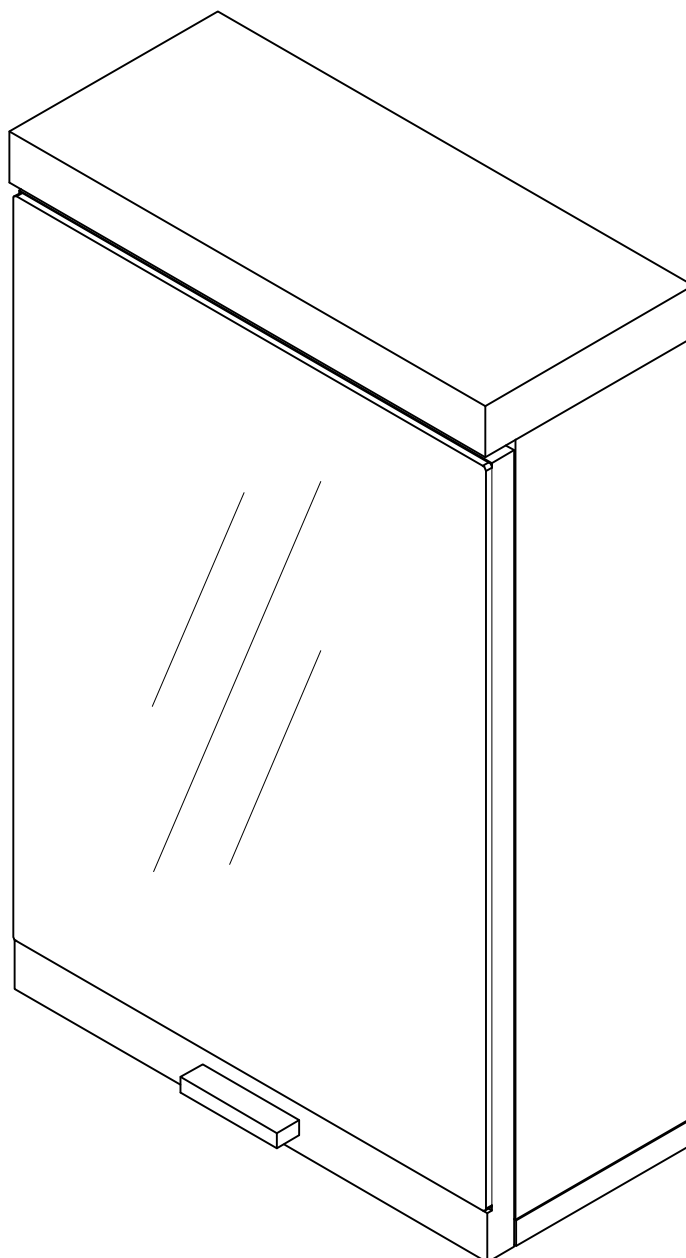

## Dimensions

Width - 32cm

Depth - 14cm

Height - 50cm

**Important - please read these instructions fully before starting assembly**

If you need help or have damaged or missing parts, call the **Customer Helpline: 0845 6400800**



## Safety and Care Advice

### Important - Please read these instructions fully before starting assembly

- Check you have all the components and tools listed on pages 1 and 2.
- Remove all fittings from the plastic bags and separate them into their groups.
- Keep children and animals away from the work area, small parts could choke if swallowed.
- Make sure you have enough space to layout the parts before starting.

- Do not stand or put weight on the product, this could cause damage.
- Assemble the item as close to its final position (in the same room) as possible.
- Assemble on a soft level surface to avoid damaging the unit or your floor.
- Parts of the assembly will be easier with 2 people.



- We do not recommend the use of power drill/drivers for inserting screws, as this could damage the unit. Only use hand screwdrivers.
- Dispose of all packaging carefully and responsibly.

### Glue safety - Take care when using glue, please follow the advice below

- Skin contact: Remove contamination by washing with soap and water. This procedure should also be followed prior to eating and drinking.

- Eye contact: Rinse immediately with clean water for 15 minutes and seek medical advice.

- If swallowed: Seek medical advice immediately.

### Care and maintenance

- Only clean using a damp cloth and mild detergent, do not use bleach or abrasive cleaners.

- From time to time check that there are no loose screws on this unit.

- This product should not be discarded with household waste. Take to your local authority waste disposal centre.

### Handy Hints

- Assemble all parts and bolts loosely during assembly, only once the product is complete should you fully tighten the bolts

- Regularly check and ensure that all bolts and fittings are tightened properly.

# Components - Panels

If you have damaged or missing components,  
call the Customer Helpline: 0845 6400800

Please check you have all the panels listed below

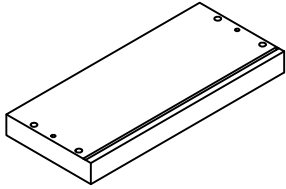

1 Top x1  
(32cm x 14cm)

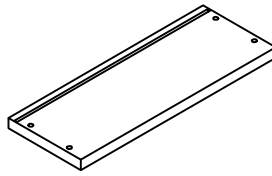

2 Bottom x1  
(32cm x 12cm)

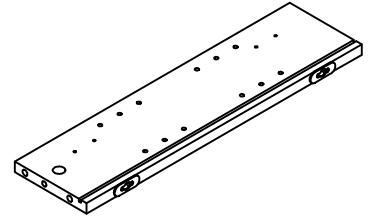

3 Left side x1  
(45.4cm x 11.9cm)

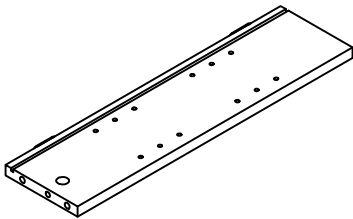

4 Right side x1  
(45.4cm x 11.9cm)

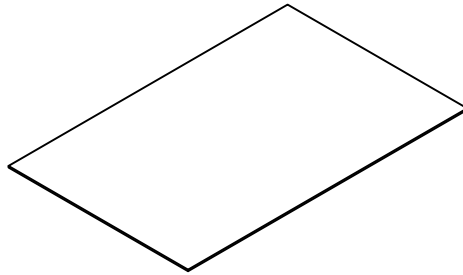

5 Back x1  
(46.2cm x 26.5cm)

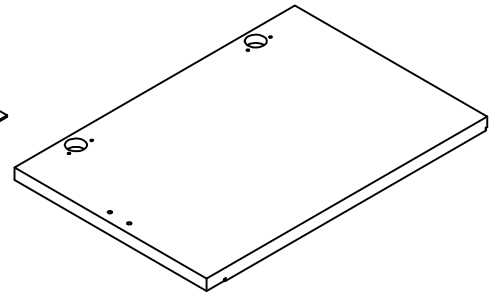

6 Door x1  
(47.4cm x 31.7cm)

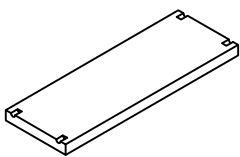











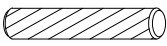
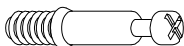

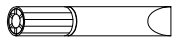

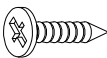

7 Adjustable shelf x2  
(28.6cm x 9.9cm)

# Components - Fittings

If you have damaged or missing components, call the Customer Helpline: 0845 6400800

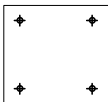
Please check you have all the fittings listed below

Note: The quantities below are the correct amount to complete the assembly. In some cases more fittings may be supplied than are required.

<p><b>A</b></p>  <p>30mm wooden dowel x 4</p>	<p><b>B</b></p>  <p>Male camlock x 2</p>	<p><b>C</b></p>  <p>Female camlock x 2</p>	<p><b>D</b></p>  <p>Glue x 1</p>
<p><b>E</b></p>  <p>Handle x 1</p>	<p><b>F</b></p>  <p>20mm Handle screw x 2</p>	<p><b>G</b></p>  <p>Shelf Support x 8</p>	<p><b>H</b></p>  <p>25mm Sticker x 2</p>
<p><b>I</b></p>  <p>Hinge x 2</p>	<p><b>J</b></p>  <p>14mm Screw x 8</p>	<p><b>K</b></p>  <p>50mm Screw x 4</p>	<p><b>L</b></p>  <p>Hex Key x 1</p>
<p><b>M</b></p>  <p>Panel Stiffeners x 4</p>	<p><b>N</b></p>  <p>Template x 1</p>	<p><b>O</b></p>  <p>Wall Plug x 4</p>	<p><b>P</b></p>  <p>32mm Screw x 4</p>
<p><b>Q</b></p>  <p>Plastic stopper x 2</p>			

## Tools required

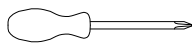

Phillips screwdriver  
(medium & large)

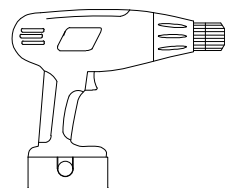

Drill

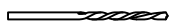

7mm Suitable drill bit  
(for use with wall plug)



Small  
hammer

## Ruler - Use this ruler to help correctly identify the screws

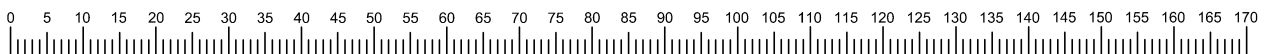

The screws length is measured from the head to the point (30mm screw shown).

# Components - Fittings

If you have damaged or missing components, call the Customer Helpline: 0845 6400800

Ruler - Use this ruler to help correctly identify the screws



## Using Camlocks

### Step 1

Connect the male camlock as directed in the assembly instructions using a screwdriver.

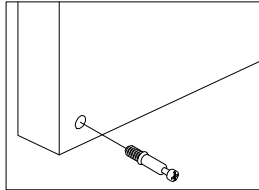

### Step 2

Insert the female camlock as shown in the instructions.

Note: ensure that the arrow on the top of the camlock points towards the entry hole for the male camlock.

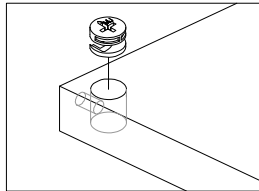

### Step 3

Push the male camlock into the entry hole.

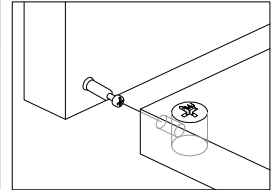

### Step 4

Turn the female camlock clockwise with a screwdriver.

You should feel a click when the camlock is locked in place.

The joint is now secure.

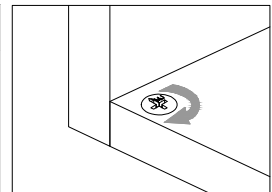

# Assembly Instructions

## Step 1

Fitting male comlocks

1. Insert 2 x male camlocks **B** into top panel **1**

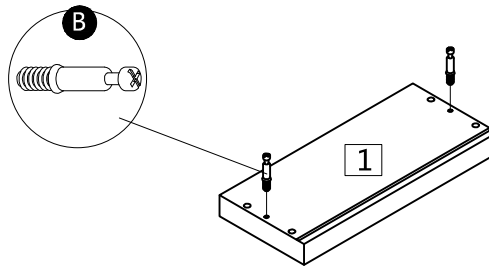

## Step 2

2. Glue and insert 4 x wooden dowels **A** into left side **3** and right side **4** as shown.

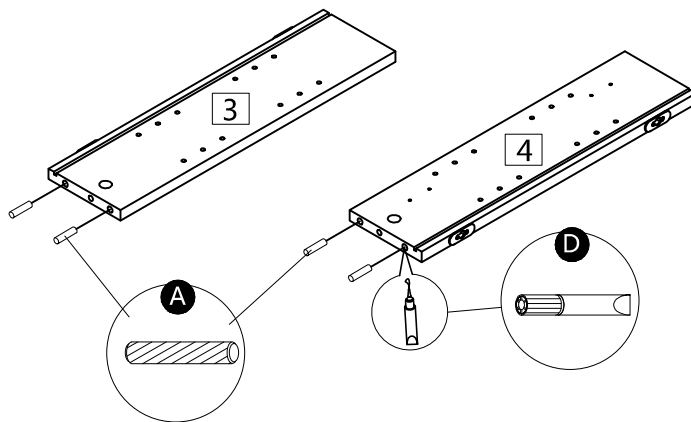

## Step 3

1. Attach bottom **2** to left side **3** and right side **4** with 4 x screws **K** using Hex key supplied to tighten

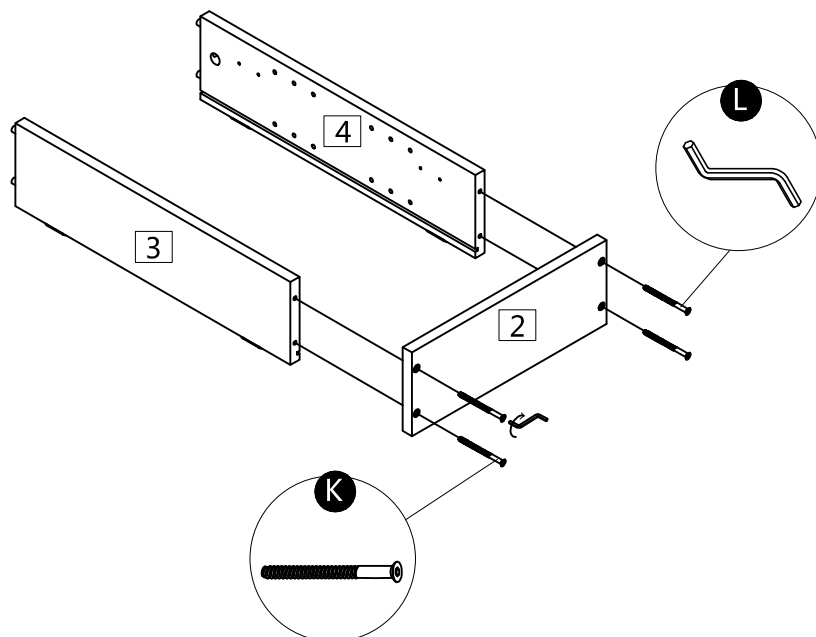

# Assembly Instructions

## Step 4

1. Slide back panel **5** along grooves in panels **3** and **4**

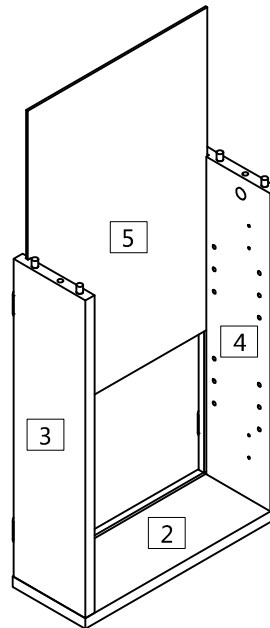

## Step 5

1. Glue holes in top panel **1** and connect to left side panel **3** and right side panel **4**

2. Insert 2 x female camlocks **C** to attach top panel **1** to left side panel **3** and right side panel **4**

Use a screwdriver to turn the female camlock clockwise to lock. Please refer to the "Using Camlocks" section at the front of this instruction for further assistance.

3. Cover visible camlocks with 2 x Stickers **H** as shown

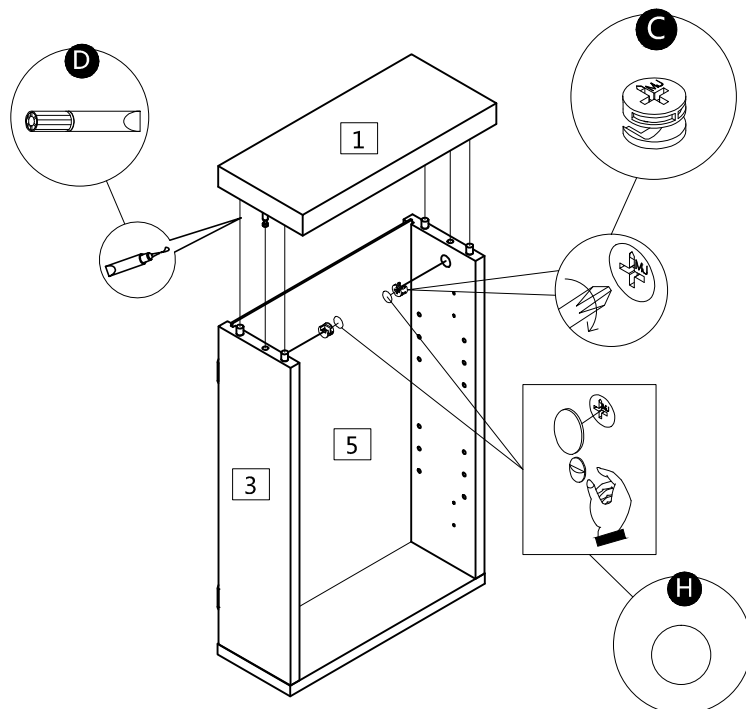

# Assembly Instructions

## Step 6

### Attach Hinge

1. Connect 2 x hinge **I** to the door with screw **J** as shown

Warning: Styrofoam or a towel should be placed beneath the mirror when doing this to prevent scratches

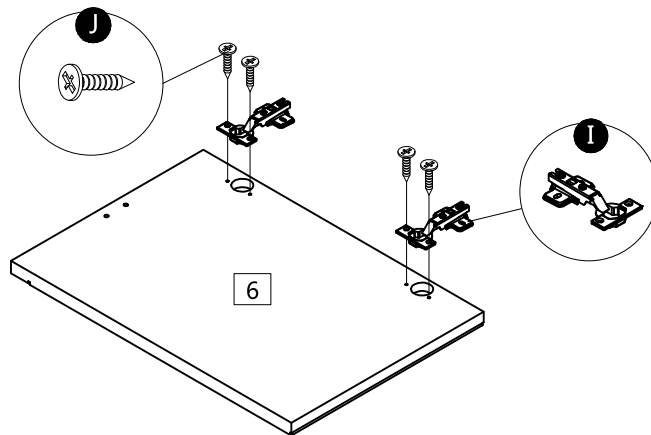

## Step 7

1. Connect door **6** to the unit with 4 x screw **J** as shown .

1. Connect 1 x handle **E** with 2 x screw **F**

### Hinge adjustment:

a: To move the doors up or down, loosen screws shown and move doors to suit

b: To move the doors in or out, loosen screws shown and move doors to suit.

### Retighten screws

c: To move the doors left or right, adjust screws shown.

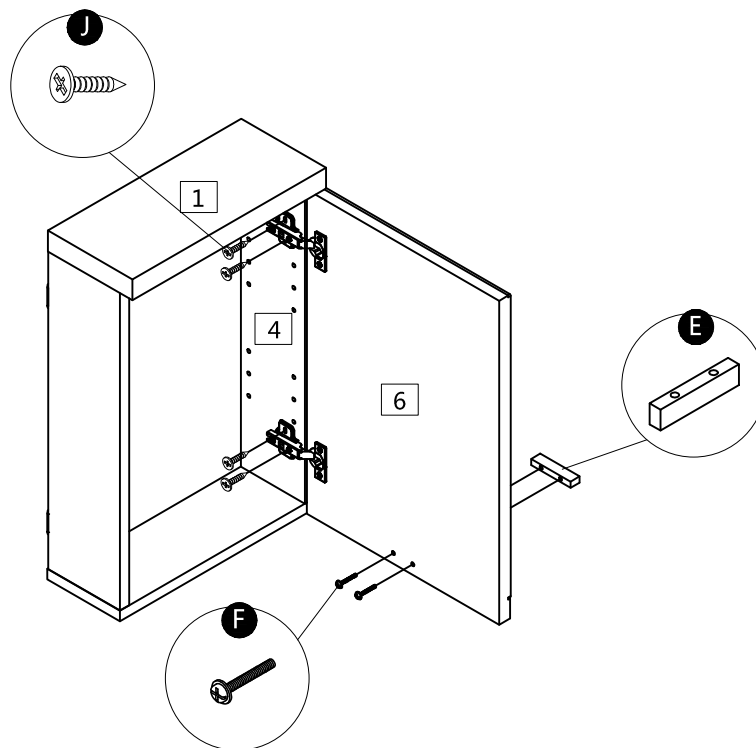

a:

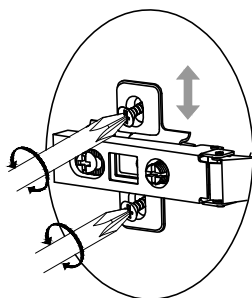

b:

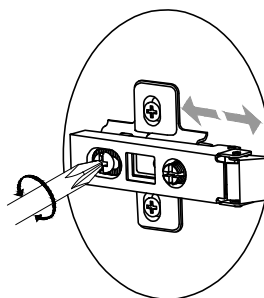

c:

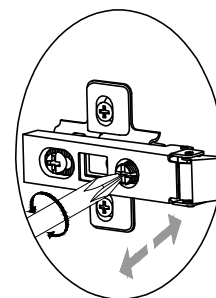



# Assembly Instructions

## Step 8

1. Insert 8 x shelf supports **G** to left side panel **3** and right side panel **4**, attach panel **7** onto shelf supports as shown.

2. Stick 2 x plastic stopper **Q** to the door as shown.

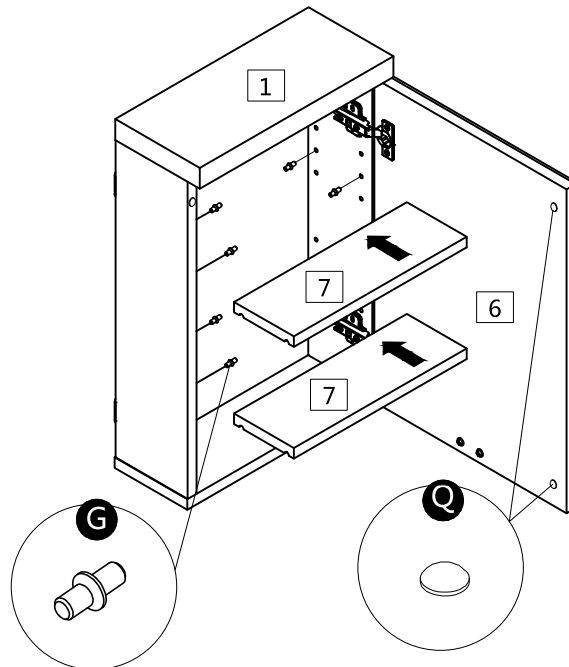

## Step 9

2. Insert 4 x panel stiffeners **M** into the back panel **5** grooves as shown. These add support and give the unit rigidity.

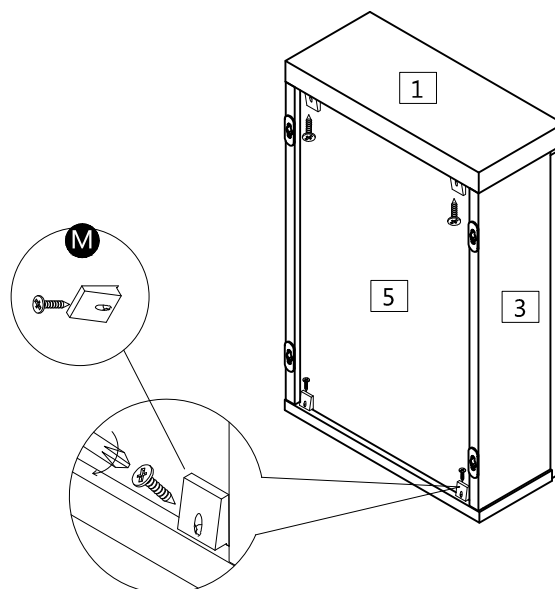

# Assembly Instructions

## Step 10

1. Use the template **N** provided to mark on the wall the position of the fixings. Please use a spirit level to ensure your markings are level



Warning:  
Before drilling, check wall for hidden pipes and cables.

2. Drill holes with a drill and a suitable drill bit.
3. Insert 4 x wall plugs **O** into each. Insert the 4 x screws **P** provided and tighten, leaving the screw head exposed by about 1/4 inch (6mm).

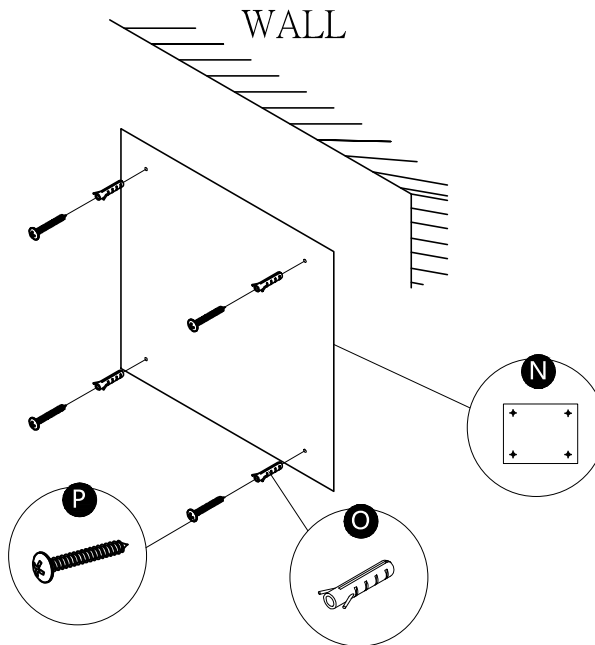

## Step 11

1. Lift the unit into position ensuring that the fixing clips attached to the unit are firmly hooked over the screw heads. Check the unit periodically to see that no fitting has loosened and needs attention

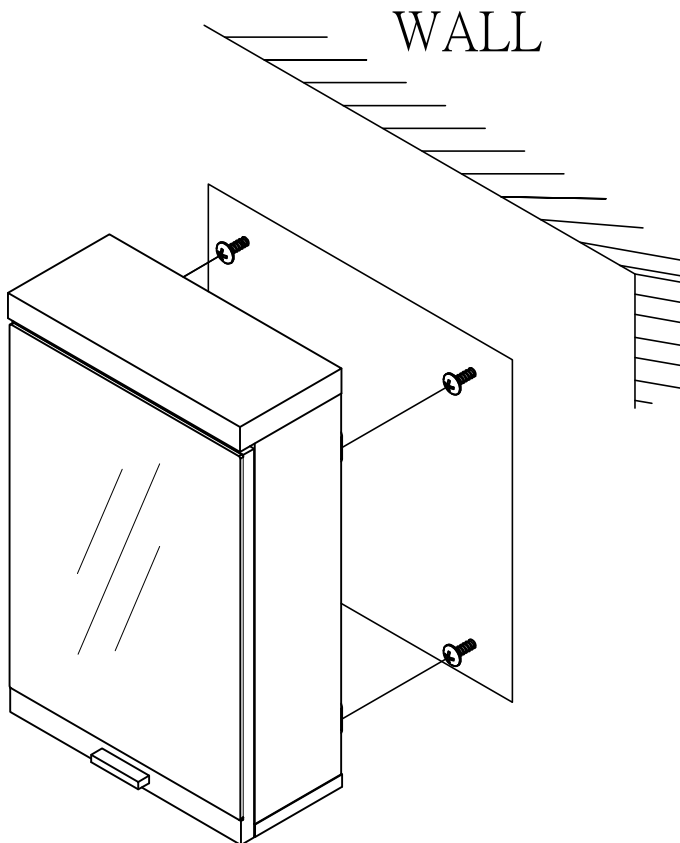

Assembly Complete

# A Guide to Wall Mounting & Fixings

## Important note:

If plastic wall plugs (rawl plugs) are supplied with your product, e.g.:

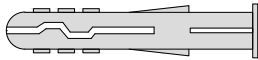

- these are only suitable for use in masonry walls.

If you are in any doubt about the correct wall plugs for your wall, seek professional advice.

Failure of the product due to using the incorrect fixings is the responsibility of the installer.



**Important:** when drilling into walls always check that there are no hidden wires or pipes etc.

Make sure that the screws and wall plugs being used are suitable for supporting your unit. Consult a qualified tradesperson if you are unsure.

Hints:

- 1: General rule:  always use a larger screw and wall plug if you are not sure.
- 2: Ensure you use the recommended drill bit to match the wall plug and hole size.
- 3: Ensure you drill the hole horizontally; do not force the drill or enlarge the hole.
- 4: Take extra care when drilling high walls, ceilings and ceramic tiles. Ensure wall plugs are inserted beyond the thickness of the ceramic tiles to avoid the tiles splitting or cracking.
- 5: Ensure wall plugs are well fitted and are a tight fit in the drilled hole.

## Types of walls

You can use one of the following types of wall plug if your walls are made of brick, breeze block, concrete, stone or wood.

No.1 "General Purpose" wall plug

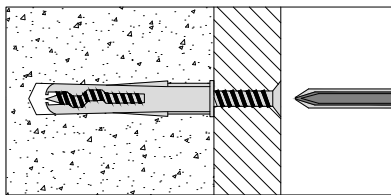

Generally aerated blocks should not be used to support heavy loads, use a specialist fitting in this case. For light loads, general purpose wall plugs can be used.

No.3 "Cavity Fixing" wall plug

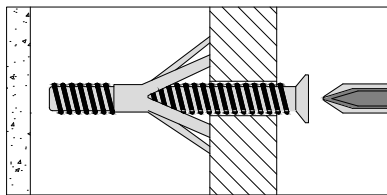

For use with plasterboard partitions or hollow wooden doors.

No.5 "Hammer Fixing" wall plug

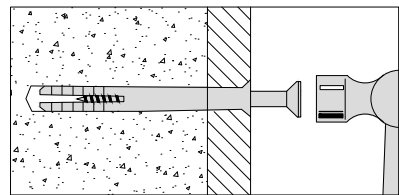

For use with walls stuck with plasterboard. The hammer fixing allows it to be fixed to the wall rather than the plasterboard. Always check the fixing is secure to the retaining wall.

No.2 "Plasterboard" wall plug

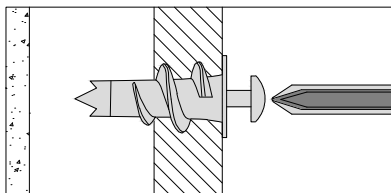

For use when attaching light loads onto plasterboard partitions.

No.4 "Cavity Fixing - Heavy Duty" wall plug

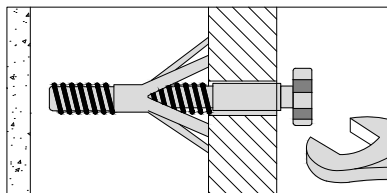

For use when fitting or supporting heavy loads such as shelving, wall cabinets and coat racks.

No.4 "Shield Anchor" wall plug - heavy loads

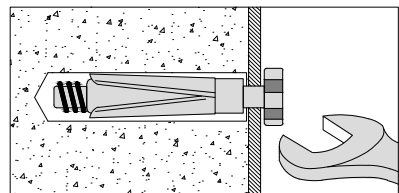

For use with heavier loads such as TV and HiFi speakers and satellite dishes etc.



## Care & Maintenance

**Safety:** always check the fitting and location to ensure your safety in and around the home.

**Fitting:** from time to time check the fitting: to ensure the wall plugs or screws do not become loose.

If you need help or have damaged or missing parts, call the

Customer Helpline: 0845 6400800