

# Cream Gazebo With Side Panels

Assembly Instructions - Please keep for future reference

292/6625

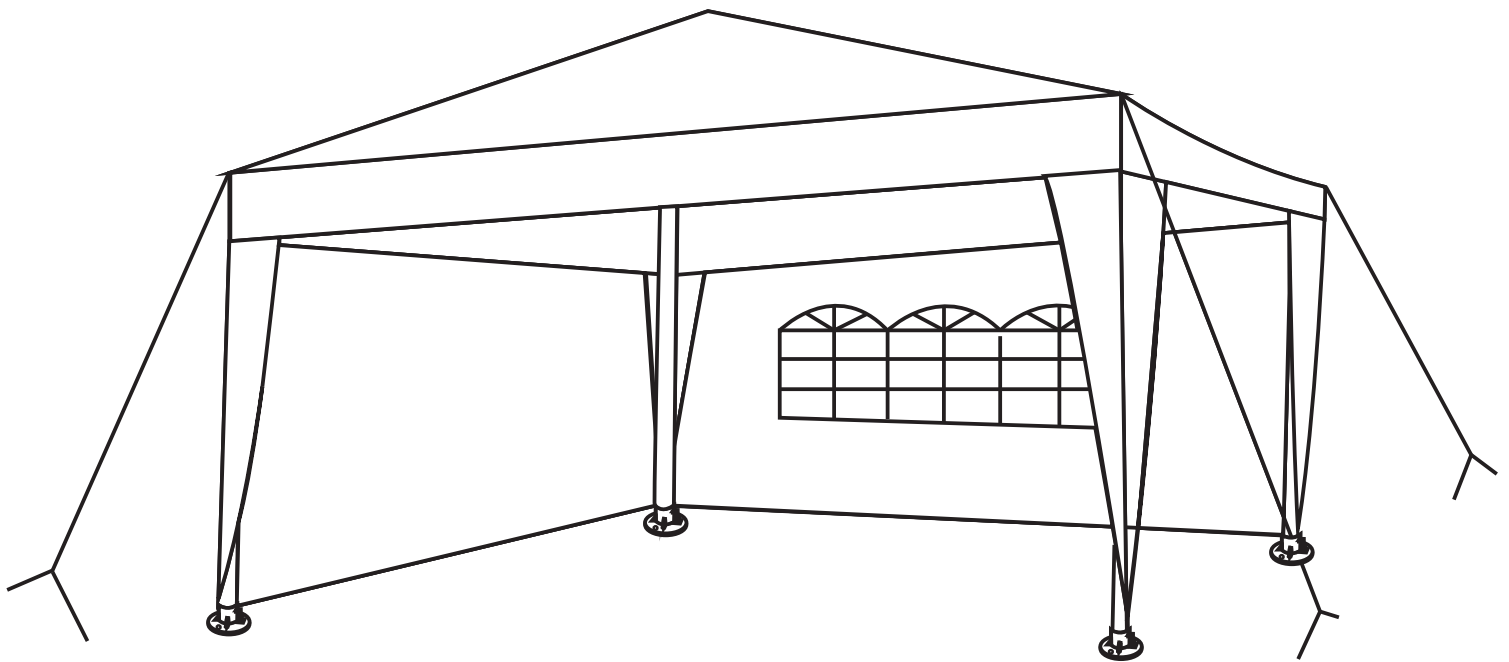

## Dimensions

Width - 270cm

Depth - 270cm

Height - 250cm

**Important** - Please read these instructions fully before starting assembly

If you need help or have damaged or missing parts, call the **Customer Helpline:**  
**Argos = 0345 640 0800**



# IMPORTANT SAFETY INSTRUCTIONS

**Read all instruction before using and keep for future reference**

- Read these instructions carefully and familiarise yourself with the procedure before assembling the unit.
- Check that you have all the component parts following the list on the page 3 and familiarise yourself with each part before proceeding.
- Take all the fittings out of the plastic bag and separate them into their groups.
- Ensure you have enough space to lay out all the parts before assembly.
- To avoid scratching it is recommended that you assemble the unit on a soft level surface.
- Please keep children away when assembly. Please keep children under direct supervision of adult when using.
- **Please do not use the gazebo under windy condition.**
- Always use guy rope and pegs to secure the gazebo when using.
- This Gazebo is not a permanent structure and should be disassembled and stored away after using.
- Do not repack your Gazebo until completely dry.
- We recommend assembly by four persons under light or no wind conditions.
- This Gazebo must not be left erect in windy conditions.
- Keep the Gazebo Fabric away from screws, nails, staples, hooks, etc to avoid damage to the fabric and frame.
- **Warning:** The unit weight approximately 7.8 kgs.
- **Please lift with care.**

## CAUTION

### Fire precautions

- Do not place the Gazebo near lights, fireplaces, gas or electric heaters, candles, radiators, or any other sources of heat, fire or flammable liquids.
- This Gazebo features a Fabric cover that is not retardant.
- We recommend caution and common sense when in use.
- This Gazebo can burning.
- Do not use naked flames in or around the Gazebo. We recommend you advise no smoking while inside.
- This Gazebo has no flame retardant cooking area and should not be use to house BBQs or other cooking methods.

### Safety

- To avoid any risks of suffocation to animals or children dispose of the plastic bags immediately.



### Cleaning

- As with all surfaces clean with a damp cloth and mild detergent, do not use bleach or abrasive products.

# Components - Parts

If you have damaged or missing components, call the Customer Helpline: Argos = 0345 640 0800

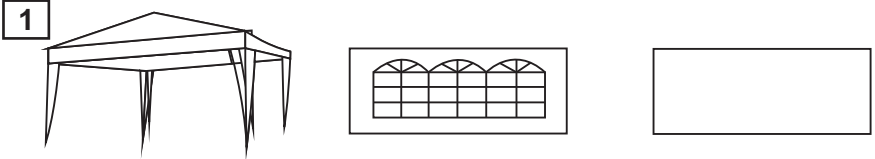
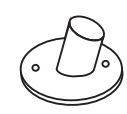
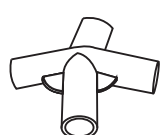
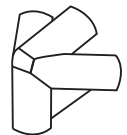
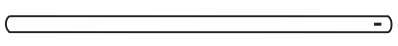
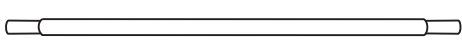
Please check you have all the parts listed below

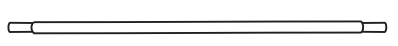
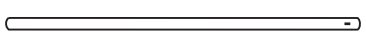
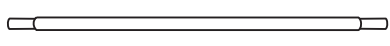
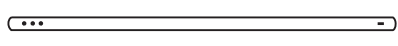
<p><b>1</b></p>  <p>1xGazebo Cover    1xPanel w/window    1xPanel w/o window</p>		<p><b>2</b></p>  <p>4xBase Plate</p>
<p><b>3</b></p>  <p>1xCenter Connector</p>	<p><b>4</b></p>  <p>4xCenter Joint</p>	<p><b>5</b></p>  <p>8xTop Pole (φ 18x565mm)</p>
<p><b>6</b></p>  <p>4xTop Pole (φ 18x688mm)</p>	<p><b>7</b></p>  <p>8xSupport Pole (φ18x810mm)</p>	<p><b>8</b></p>  <p>4xSupport Pole (φ18x785mm)</p>
<p><b>10</b></p>  <p>4xLeg Pole (φ 18x688mm)</p>	<p><b>11</b></p>  <p>4xLeg Pole (φ 18x688mm)</p>	<p><b>12</b></p>  <p>4xLeg Pole (φ 18x688mm)</p>

# Components - Fittings

Please check you have all the fittings listed below

**Note:** The quantities below are the correct amount to complete the assembly. In some cases more fittings may be supplied than are required.

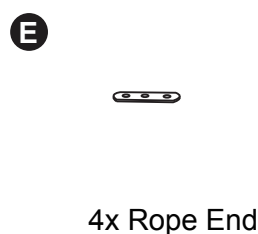
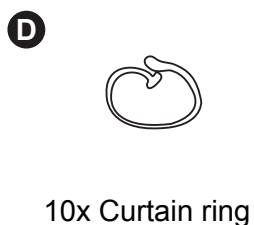
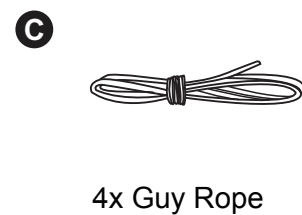
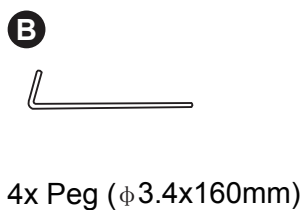
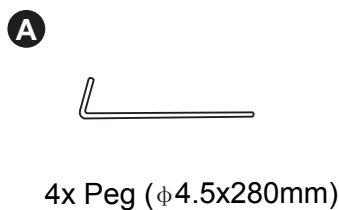

# Assembly Instructions

## Step 1

### Assembling support poles

Insert support pole **8** into the support pole **7** ensure all the poles are fully inserted and secure.



**Important note:** Because of the size of this unit we recommend that it

Ensure to locate the unite on the flat ground free from obstruction, in a sheltered area away from wind and heavy rain as this will damage the unit.

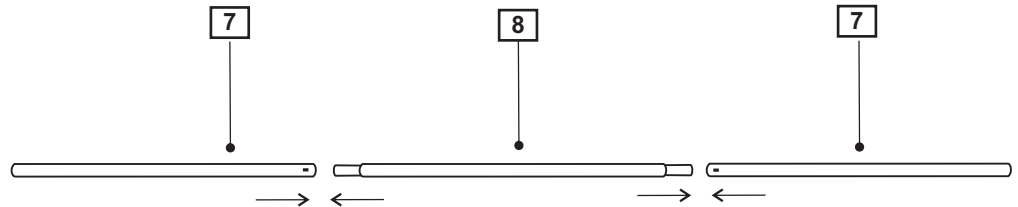

## Step 2

### Assembling corner joints

Use corner joints **4** to connect the support poles. Ensure all the poles are fully inserted and secure.

**Note:** It would be useful to ask someone to help you at this step.

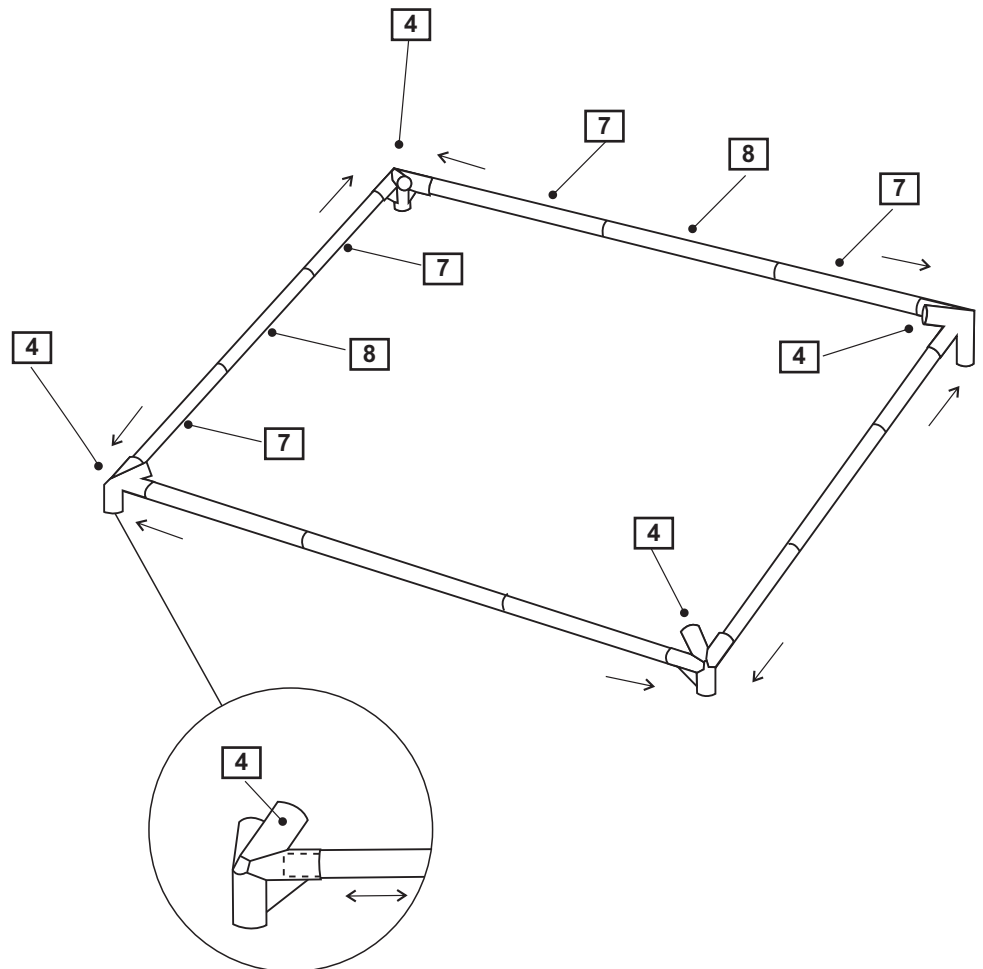

# Assembly Instructions

## Step 3

### Assembling top poles

Insert top poles **6** into the top poles **5**. Ensure all the poles are fully inserted and secure.

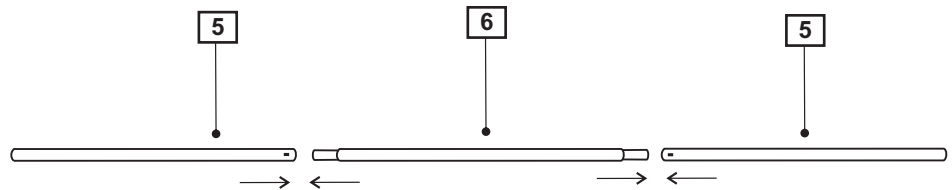

## Step 4

### Assembling corner joints and centre connector

Connect the top pole to corner joints **4** and centre connector **3**

**Note:** It would be useful to ask someone to help you at this step.

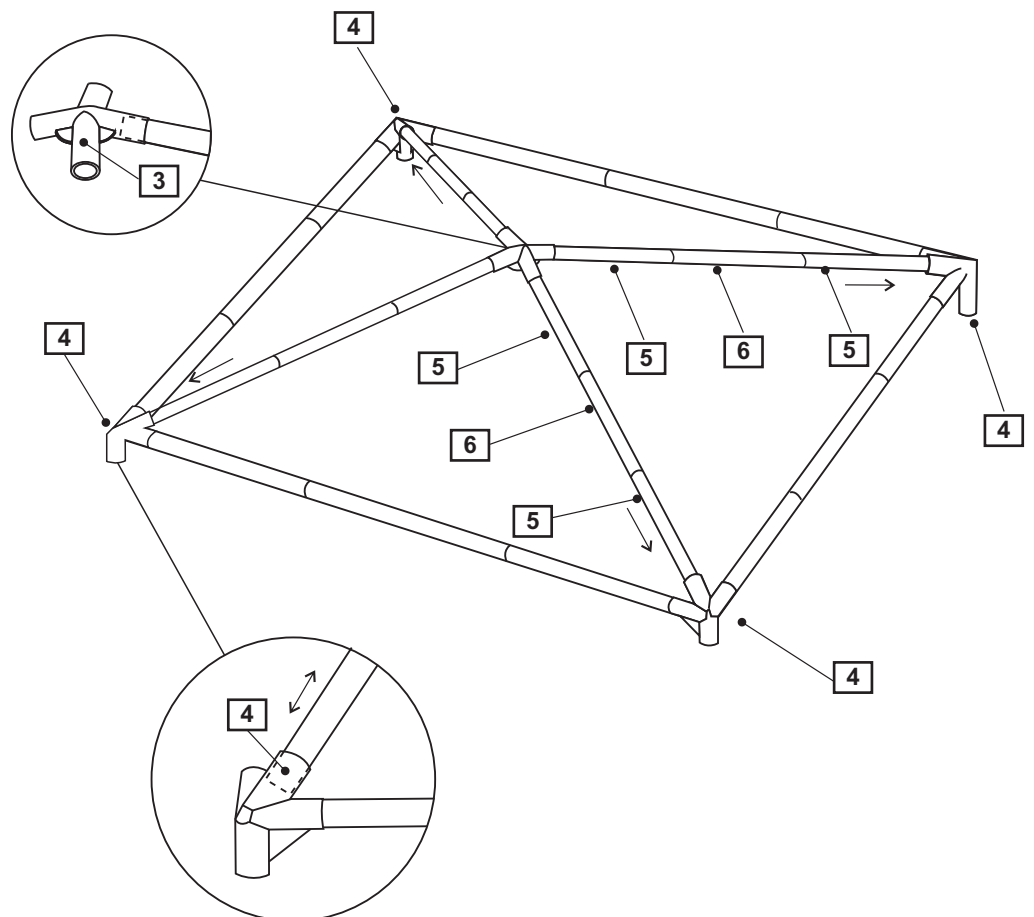

# Assembly Instructions

## Step 5

### Assembling leg poles

insert leg poles **10** into the unite. Ensure all the poles are fully inserted and secure.

**Note:** It would be useful to ask someone to help you at this step.

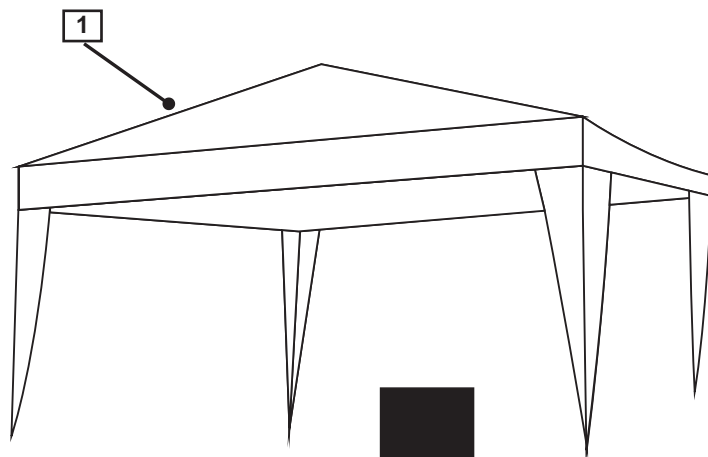
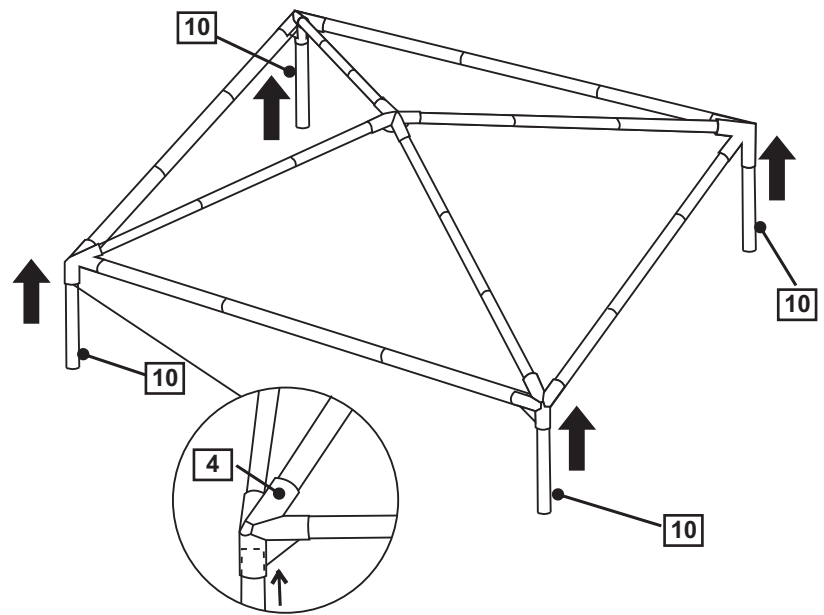

## Step 6

### Assembling gazebo covers

Carefully place the gazebo cover **1** over the assembled roof. Then pull the gazebo tightly over the assembled roof frame.

**Note:** It would be useful to ask someone to help you at this step.

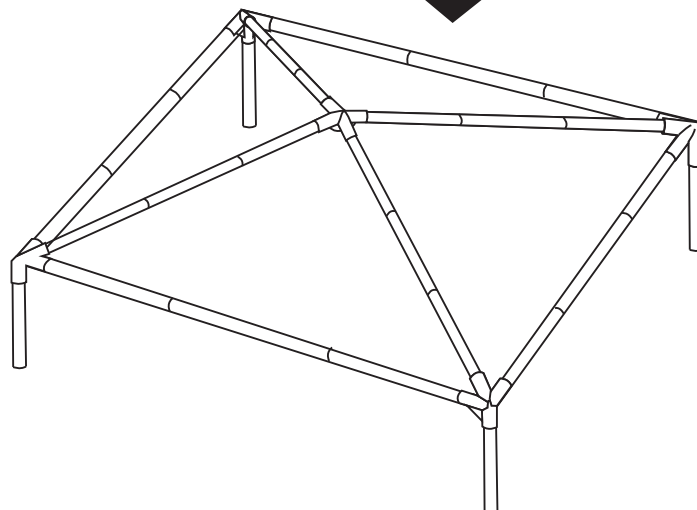

# Assembly Instructions

## Step 7

### Fixing leg poles

**a:** insert the base plate **2** into the leg pole **12**

**b:** insert leg poles **12** into leg poles **11**. Then insert the whole connected leg poles into the unit. Ensure all the poles are fully inserted and secure.

**Note:** It would be useful to ask someone to help you at this step.

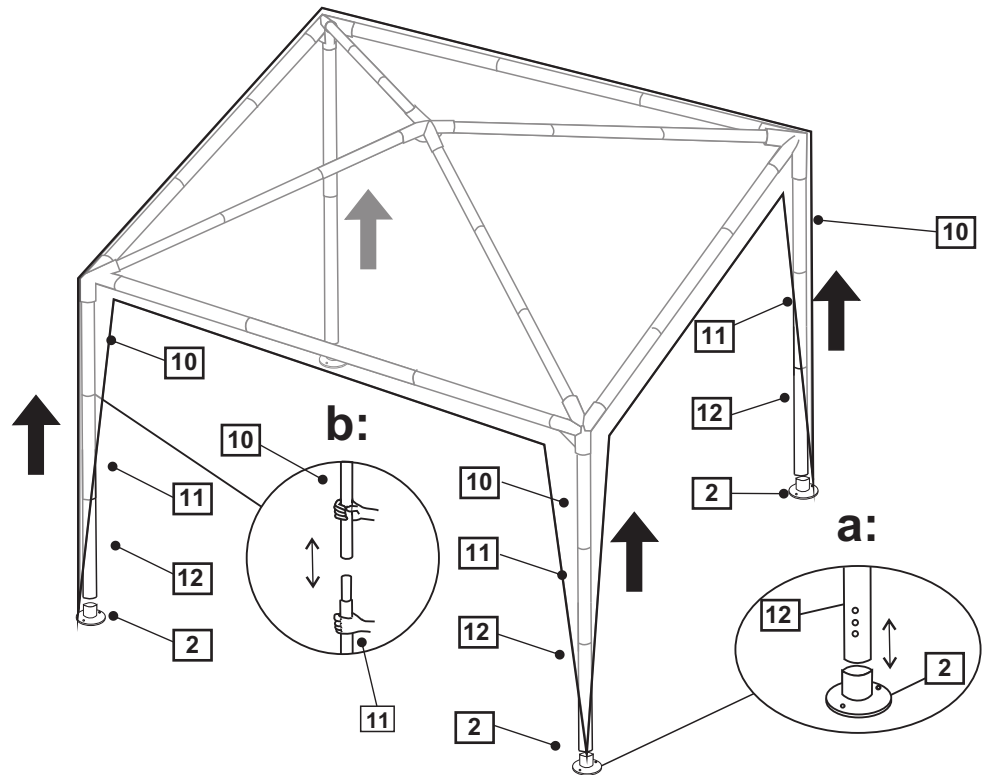

## Step 8

### Fixing the gazebo cover

**c:** use the velcro tapes inside the gazebo cover to fix it onto the assembled frame

**d:** attach the gazebo cover's hooks into holes on the leg poles **12**. Tighten by moving the hook to a lower hole.

**Note:** It would be useful to ask someone to help you at this step.

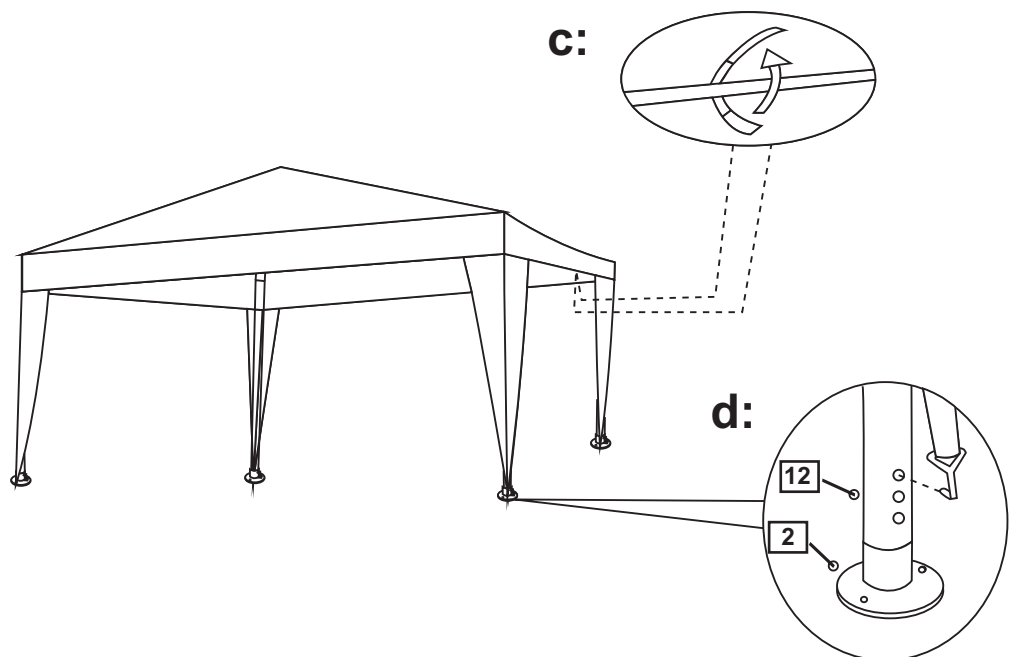

# Assembly Instructions

## Step 9

### Fitting the guy ropes

**a:** Attach **E** on the guy rope **C** so that the length of guy ropes can be adjusted.

**b:** attach the end of the guy rope **C** to the corner of the top cover ring on the gazebo. Then attach the other end to peg **A** and drive the peg into the ground.

*Repeat above steps to assemble the other guy ropes.*

**C:** use the peg **B** to fix the base plates **2**

**Note:** the pegs are for location purposes only, they will not support the unit in high winds, see above instructions.

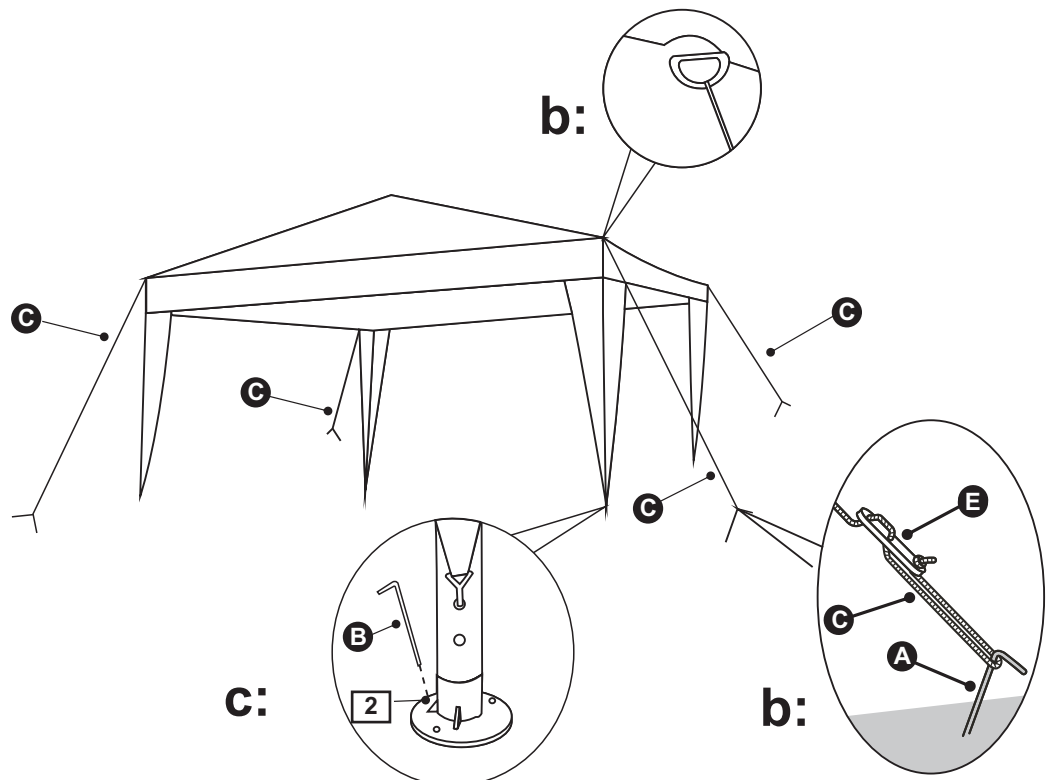
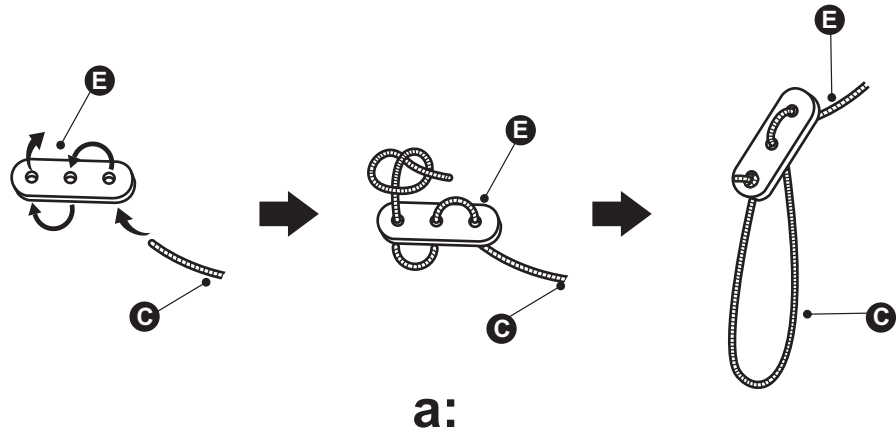



# Assembly Instructions

## Step 10

### Fitting the panels

**a:** Hang on the two panels at the top using the curtain ring **D**

**b:** Use the velcro tapes at side of panels to fasten to the gazebo legs.

Side panels can be taken off separately.

### **Warning:**

Do not assemble or disassemble during strong winds.

**Assembly is complete.**

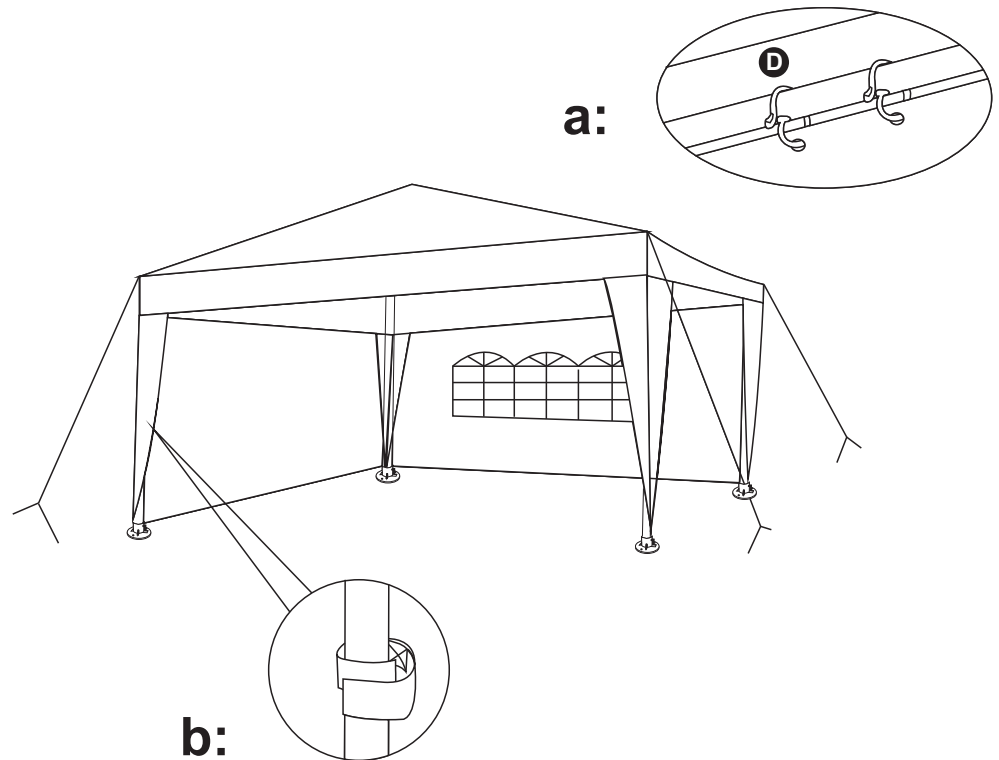

**Important note:** always use this product with caution and read the important safety instructions.

If you need help or have damaged or missing parts, call the **Customer Helpline:**  
**Argos = 0345 640 0800**