

# SOVEREIGN

24V Lithium-Ion Cordless Rotary Mower <sup>2908777</sup>  
(Model: CLMF2432M)

Instruction Manual



## After Sales Support

UK/Ireland  
Web

0345 640 0800  
[www.argosspares.co.uk](http://www.argosspares.co.uk)

**Important** - Please read these instructions fully before starting assembly

These instructions contain important information that will help you get the best from your mower, ensuring it is assembled correctly and safely.

If you need help or have damaged or missing parts, call the Customer Helpline on 0345 640 0800.

# Contents

Safety Information.....	3
Warning Symbols.....	3
General Safety.....	5
Isolator Key Safety.....	7
Frequent Maintenance.....	7
Battery Safety.....	8
In the Box .....	10
Parts.....	10
Assembly .....	11
Step 1 - Handle Base Assembly .....	11
Step 2 - Top Handle Assembly and Adjustment for Operator Height .....	12
Step 3 - Fitting / Removing the Grass Collector.....	13
Fitting and Removing the Battery .....	14
Operating Instructions & Tips .....	15
Setting the Cutting Heights.....	15
Starting and Stopping.....	16
Mowing Advice.....	16
ON/OFF Operation.....	17
After Mowing / Storage .....	18
Battery Charging.....	19
Charger LEDs.....	19
Battery LED Panel.....	20
Maintenance.....	21
General Maintenance.....	21
Battery Maintenance .....	21
Blade Maintenance .....	22
Troubleshooting .....	23
General Troubleshooting .....	23
Technical Data.....	25
Technical Data Table.....	25
Transport .....	25
Disposal.....	25
Disposal and Recycling.....	25
Getting Help .....	26

# Safety Information

Important - Please read these instructions fully before starting assembly

## Warning Symbols

The following warning symbols appear throughout this assembly manual and indicate the appropriate safety measures you should take when assembly and operating the mower.



Take extra care, beware of hazards.



Read instruction manual.



Do not use the machine in the rain or leave it outdoors when it is raining.



Pay attention that bystanders are not injured by objects thrown out from the machine.



Keep bystanders a safe distance away from the machine.



Sharp blade. Beware of injury to toes or fingers.



Switch off and remove the isolator key before adjusting, cleaning or before leaving the product unattended for any period.



Disconnect from the mains supply before any maintenance work.



Warning. Beware of electric shocks.



# Safety Information

Important - Please read these instructions fully before starting assembly

## Warning Symbols (continued)



Wait until all moving parts have stopped completely before touching them. The blade may continue to rotate after the machine is switched off, a rotating blade can cause injury.



Only use the battery charger indoors.



The battery charger contains a safety transformer.



**IMPORTANT!** When using equipment, the following safety precautions must be followed to avoid injuries and damage.

- Read all operating instructions carefully and comply with them. It is important to understand these instructions and to acquaint yourself with the machine, its correct usage and all safety requirements.
- Keep this manual in a safe place so that the information is available at all times.
- If you give the equipment to any other person, give them these operating instructions as well.

We accept no liability for damage or accidents which result from non-compliance with these instructions.



# Safety Information

Important - Please read these instructions fully before starting assembly

## General Safety

- Never allow children or people unfamiliar with these instructions to use the machine. Local regulations may restrict the age of the operator. When not in use, store the machine out of reach of children and remove the isolator key.
- This appliance is not intended for use by persons (including children) with reduced physical, sensory or mental capabilities, or lack of experience and knowledge, unless they are closely supervised or have received sufficient instruction concerning the use of the appliance by a person responsible for their safety. Children should be supervised to ensure that they do not play with the appliance.
- Never mow while people, especially children or pets, are nearby.
- The operator or user is responsible for accidents or hazards occurring to other people or their property.
- Do not operate the machine when barefoot or wearing open sandals, always wear substantial footwear and long trousers.
- Thoroughly inspect the area where the machine is to be used and remove all stones, sticks, wires, bones and other foreign objects.
- Before usage, always visually inspect to check that the blades, blade bolts and cutter assembly are not worn or damaged. Replace worn or damaged blades and bolts in sets to preserve balance.
- Mow only in daylight or in good artificial light.
- Avoid operating the machine in wet grass, where feasible.
- Walk, never run.



# Safety Information

Important - Please read these instructions fully before starting assembly

## General Safety (continued)

- Never operate the appliance with defective guards or shields. Only operate the device if all original safety devices, such as deflectors and/or grass catchers, are correctly fitted.
- Working on sloping areas can be dangerous.
  - Do not mow on excessively steep slopes.
  - Always be sure of your footing on slopes or wet grass.
  - Mow across the face of slopes – never up and down.

Exercise extreme caution when changing direction on slopes.

Use extreme caution when stepping back or pulling the machine towards you.

Never mow by pulling the mower towards you.

- Stop the motor and blade if the machine has to be tilted for moving across surfaces other than grass and when transporting the machine to and from areas to be mowed.
- Do not tilt the machine when starting or switching the motor on, except if the machine has to be tilted for starting in long grass. In this case, do not tilt it more than absolutely necessary and tilt only the part which is away from the operator. Always ensure that both hands are in the operating position on the handle before returning the machine to the ground.
- Switch the motor on according to the instructions with feet well away from rotating parts.
- Do not put hands or feet near or under rotating parts.
- Always stand clear of the discharge zone when operating the machine.



# Safety Information

Important - Please read these instructions fully before starting assembly

## General Safety (continued)

- Never pick up or carry the machine while the motor is running.
- **Do not modify this appliance.** Unauthorized modifications may impair the safety of your product and may result in increased noise and vibration.

## Isolator Key Safety

- Remove the isolator key-whenver you leave the machine,
- before clearing a blockage,
- before checking, cleaning or working on the machine,
- after striking a foreign object. Inspect the machine for damage and make repairs as necessary,
- if the machine starts to vibrate abnormally ( and check it immediately).

## Frequent Maintenance

- Always wear gardening gloves when handling or working near the sharp blade.
- Ensure all nuts, bolts and screws are tight before each operation to ensure the machine is in a safe working condition.
- Check the grass collector frequently for wear or deterioration.
- Examine the machine and replace worn or damaged parts.
- Ensure that replacement parts are correctly fitted.
- Only use approved replacement parts.



## Safety Information

Important - Please read these instructions fully before starting assembly

### Battery Safety

- **Ensure the switch is in the 'off' position and the key removed before inserting the battery pack.** Inserting the battery pack into a machine while the key is inserted could result in an accident.
- **Keep the battery charger away from rain or moisture.** Water penetration inside the battery charger increases the risk of an electric shock. Store in a dry environment.
- **Recharge only with the charger specified by the manufacturer.** A charger that is suitable for one type of battery pack may create a risk of fire when used with another battery pack.
- **Do not charge other batteries with this charger.** This could cause fire or an explosion.
- **Keep the battery charger clean.** Contamination can lead to danger of an electric shock.
- **Before each use, check the battery charger, cable and plug. If damage is detected, do not use the battery charger. Never open the battery charger yourself. Have repairs performed only by a qualified technician and only using original spare parts.** Damaged battery chargers, cables and plugs increase the risk of an electric shock.
- **Do not operate the battery charger on easily inflammable surfaces (e. g. paper, textiles, etc.) or surroundings.** The heating of the battery charger during the charging process could pose a fire hazard.





## Safety Information

Important - Please read these instructions fully before starting assembly

### Battery Safety (continued)

- **When the battery pack is not in use, keep it away from other metal objects such as paper clips, coins, keys, nails, screws or other small metal objects that could create a connection from one terminal to another.** Shorting the battery terminals together can cause burns or a fire.
- **Under abusive conditions, liquid may be ejected from the battery. Avoid any contact with this liquid. If contact accidentally occurs, flush with water. If liquid contacts eyes, also seek medical help.** Liquid ejected from the battery may cause irritations or burns.
- **Do not open the battery.** Danger of short-circuiting.
- Protect the battery from heat, e. g. from continuous intense sunlight, fire or other heat source. Danger of explosion.
- **Do not short-circuit the battery.** There is danger of explosion.
- **In case of damage or improper use of the battery, vapours may be emitted. Ensure the area is well ventilated and seek medical help in case of complaints.** The vapours can irritate the respiratory system.
- **Protect the battery against moisture and water.** Store in a dry environment. Make sure it's out of reach of children.
- Store the battery only within a temperature range between 0 °C and 25 °C. For example, do not leave the battery in the car in summer.
- Occasionally clean the venting slots of the battery using a soft, clean and dry brush.

# In the Box

## Parts

- |                          |                                   |                                  |                                   |
|--------------------------|-----------------------------------|----------------------------------|-----------------------------------|
| 1 Top handle             | 9 Front wheel                     | 15 Safety button                 | 21 Battery charger mains plug     |
| 2 Switch Lever           | 10 Deck of motor housing          | 16 Battery LED charge indicators | 22 Grass collector full indicator |
| 3 Handle fastner(x2)     | 11 Battery compartment cover      | 17 Battery release button        |                                   |
| 4 low handle bar(x2)     | 12 Height of cut adjustment lever | 18 Battery latch                 |                                   |
| 5 Grass collector handle | 13 Carrying slot                  | 19 Charger                       |                                   |
| 6 Deflector guard        | 14 Cable clip                     | 20 Battery charge status display |                                   |
| 7 Grass collector        |                                   |                                  |                                   |
| 8 Rear wheel             |                                   |                                  |                                   |



# Assembly

## Step 1 - Handle Assembly

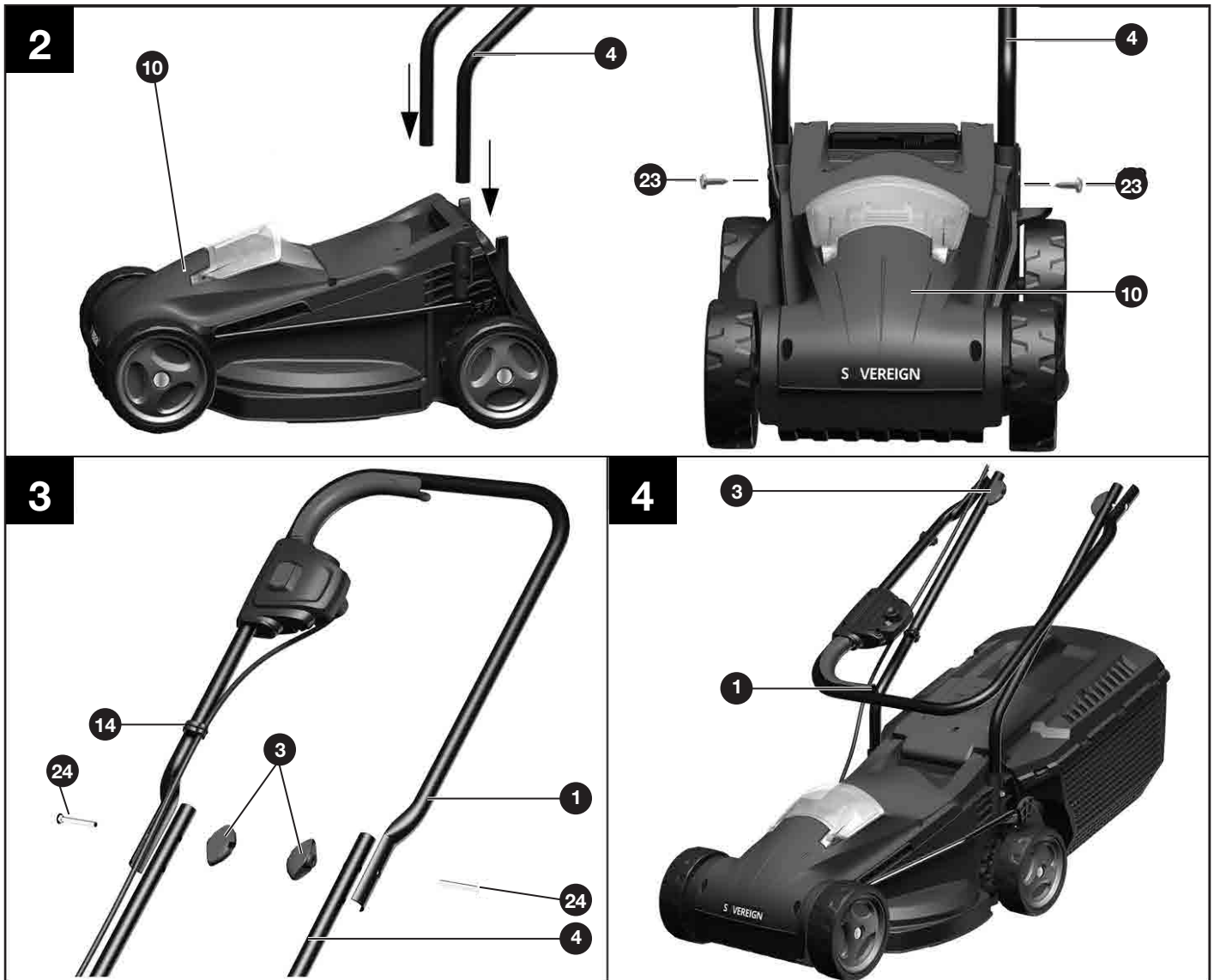

- Insert the each lower handle bar **4** into the slot in the deck **10**
- Use the 2 screws **23** provided to lock each bar into position in the deck.
- Fix the top curved handle **1** section to the lower handle bars **4**. Use the bolts **24** and wing nut fasteners **3** provided. There are two possible height positions. Chose the one most suitable to the operator's height.
- Clip the cable to the handle bar with the cable clip **14** provided.

When the two wing nuts are loosened, the handle can be folded (Fig.4 ) for easy storage. Ensure the power cable is not caught between the folding sections.

# Assembly

## Step 2 - Top Handle Assembly and Adjustment for Operator Height

5a

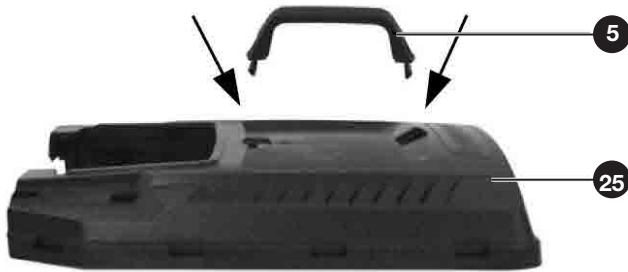

5b



5c



5d

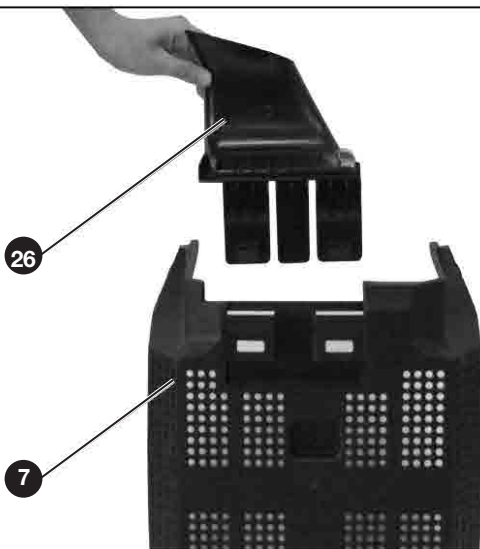

# Assembly

## Step 2 - Top Handle Assembly and Adjustment for Operator Height (continued)

- 5a.** Clip the handle **5** into the top half of the grass box **25**
- 5b.** Align the fronts end of the top half and the bottom half of the grass collector box. Clip the two halves together starting at the front.
- 5c.** Once the front clips on either side are secure, work back on either side to secure each clip . This method will help to keep the two halves of the box aligned.
- 5d.** Finally, press the insert **26** into the grass collector **7** as shown in 5d, and make sure the insert is located securely in position. This insert assists the grass flow into the grass collector when the grass collector is fitted to the mower.



**ATTENTION!** Never operate the mower unless the deflector guard and grass collector are fully installed. Risk of injury!

## Step 3 - Fitting / Removing the Grass Collector

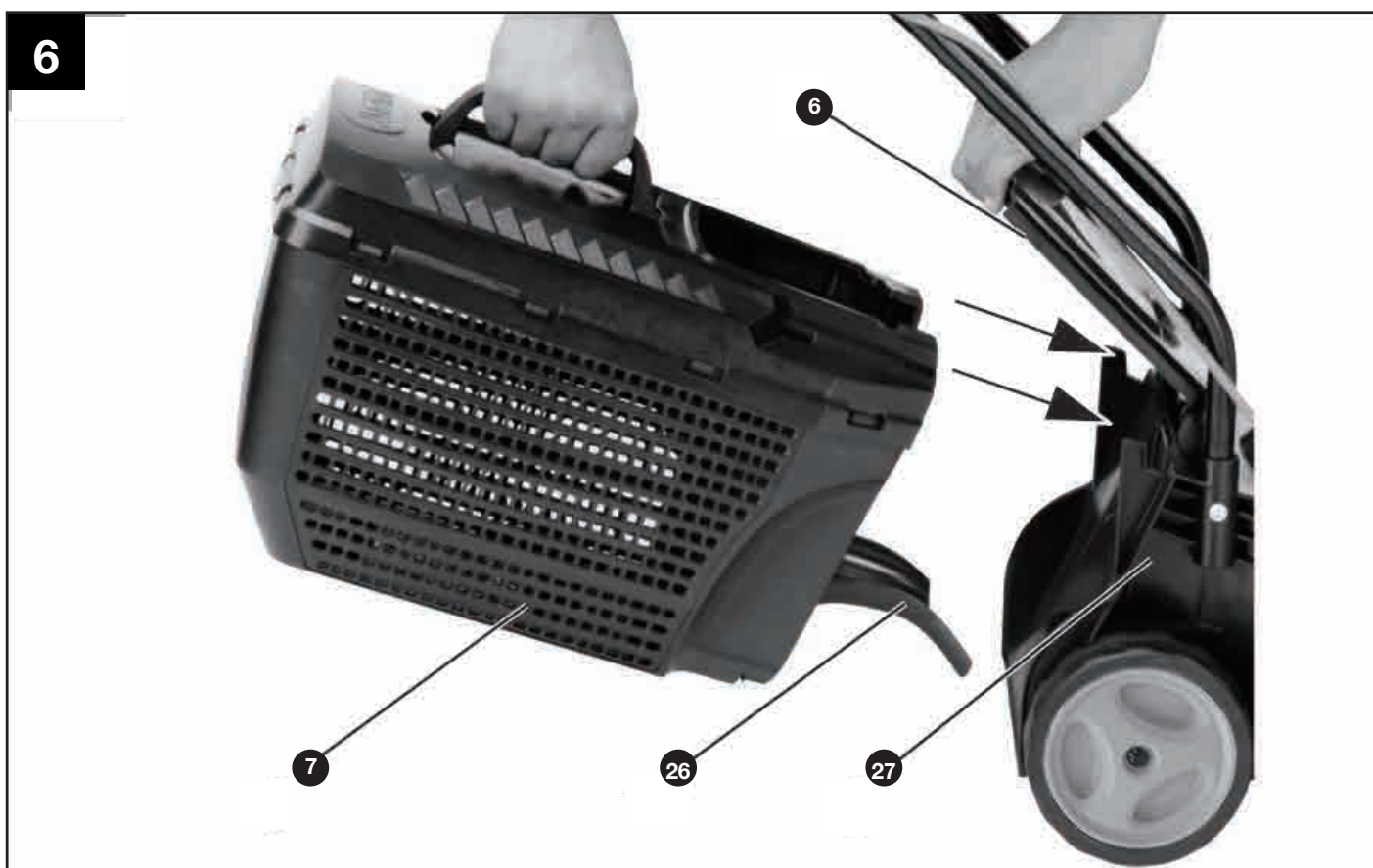

- Lift the deflector guard **6**
- Place the grass collector **7** on the mounting bracket **27** at the back of the lawn mower. Ensure the grass collector fits snugly against the mower deck.
- Lower the deflector guard **6** onto the grass collector **7** – a spring tensioner holds it in place.
- To remove the grass collector **7** , lift the deflector guard **6** and unhook the grass collector from the mounting bracket. Ensure the deflector returns down to its original position.

# Assembly

## Fitting and Removing the Battery

7



### Fitting the battery

Lift the battery cover **11** until it locks into standing position, slide the battery into the battery chamber. Ensure it slides smoothly along the support rails and locks into position. Close the battery cover.

### Removing battery

Stop the machine. Pull out the isolator key. Lift the battery cover, activate the release latch on the battery and slide the battery out. Close the battery cover.

# Operating Instructions & Tips

## Setting the Cutting Heights

8



**Stop the machine, release the switch lever and wait until the blade stops before adjusting the cutting height. Remember, the blade may continue to rotate after the machine is switched off. A rotating blade can cause injury.**



**CAUTION!** Do not touch rotating blades.

For the first cut each season, a higher cutting setting should be selected.

Using a cutting height that is too low in longer grass will use more power and shorten battery run time. It is recommended to cut longer grass in 2 times or more. This method will also cause less stress to your grass for a healthier lawn.

# Operating Instructions & Tips

## Starting and Stopping

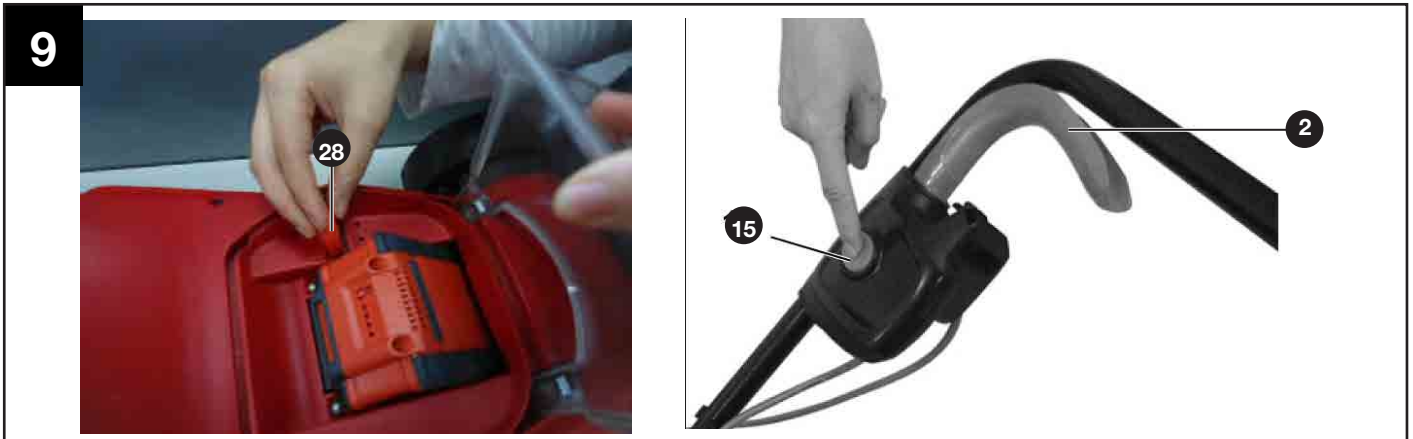

**Always remember that the blade may continue to rotate for a few seconds after the machine is switched off. Allow the motor/blade to stop rotating before switching “on” again. Do not rapidly switch off and on.**

### Starting:

- Insert the isolator key **28**.
- Press and hold the safety lock-off button **15**.
- squeeze the switch lever **2** towards the handle,
- release the safety button **15**.



**NOTE!** There is a short delay before the motor starts after engaging the switch lever.

### Stopping:

Release the switch lever. If the mower is not going to be used immediately pull out the isolator key.

## Mowing Advice



**When mowing do not allow the motor to labour, particularly in heavy conditions. When the motor labours the speed of the motor drops and you will hear a change in the motor sound. If the problem persists, set the cutting height to a higher setting.**

Protect the battery from heat, from continuous exposure to sun and keep away from radiation or other heat sources. Do not leave the battery in the mower in direct sunlight over long periods.



**The mower will not function if temperature is below -5°C or above 70°C!**



The Electronic Cell Protection (ECP) protects the Lithium-ion battery against deep discharging. When the battery is run down or discharged, a protective circuit shuts power off to the motor. The motor will not run and the blade will not rotate until the battery is recharged.



# Operating Instructions & Tips

## ON/OFF Operation

10

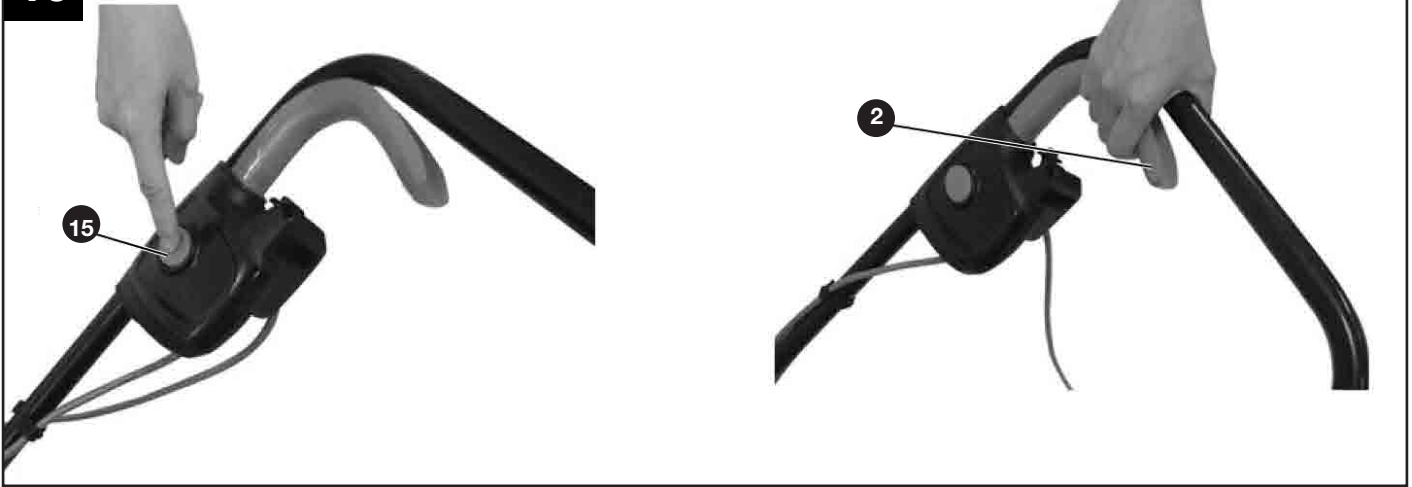

- Connect the mower to your power supply socket.
- Before switching on, ensure that the mower is not in contact with any foreign objects.
- To switch on, press the safety lock-off button **15** on the handle, then activate the start/stop switch lever **2**. Release the lock-off button **15**.
- To switch off, release the start/stop switch lever **2**.



After switching off the equipment, the blade may continue to turn for several seconds. Do not touch the moving blade. There is a risk of serious injury.

# Operating Instructions & Tips

## After Mowing / Storage

11



### Safety warnings

Always wear gloves when handling or working near sharp blades

Switch off, remove the isolator key, battery and grass collecto before adjusting or cleaning

For safety of other users remove the isolator key before storage.

It is recommended that you remove the battery from the product and store it at room temperature when it is not in use. As a guide the ideal storage temperature for maximum battery longevity is 0 °C ~ 25 °C. Storing the battery in an environment below 0 °C or above 25 °C will affect the longevity of the battery.

Clean the exterior of the machine thoroughly using a soft brush and cloth. Do not use water, solvents or polishes. Remove all grass and debris, especially from the ventilation slots.

Turn the machine on its side and clean the blade area. If grass cuttings are compacted in the blade area, remove with a wooden or plastic implement.

Store the machine in a dry place. Do not place other objects on top of the machine.

To aid storage lift then loosen the quick release fasteners and fold the handles.

Ensure cables are not trapped when folding/unfolding top handles, do not drop the handles onto the mower body.

# Operating Instructions & Tips

## Battery Charging

12



- **Do not use other battery chargers.** The battery charger supplied is specifically designed for the Lithium-Ion battery used in this garden appliance.
- **Check the mains voltage!** The voltage of the power supply must correspond with the data on the nameplate of the battery charger. Battery chargers operate on 220-240 V.

The battery is equipped with a temperature monitor that allows charging only within a temperature range between -5 °C and 50 °C. This ensures an optimum battery service life.



**NOTE!** The battery is supplied partially charged. To ensure full capacity of the battery, charge the battery in the battery charger before using your appliance for the first time. The Lithium Ion battery can be charged at any time without reducing its service life. Interrupting the charging procedure does not affect the battery.

## Charger LEDs

**Preparation:** The charging process starts as soon as the mains plug of the battery charger is plugged into a mains socket and the battery is inserted into the charging compartment.

If the battery is not inserted, a **continuous red light** indicates that the mains plug is plugged into a mains socket and the battery charger is ready for operation.

**Charging: a flashing green LED** on the charger indicates that the battery is charging normally.

**Charged: continuous green LED** on the charger indicates that the battery is ready for use.

# Operating Instructions & Tips

## Charger LEDs (continued)

The intelligent charger measures the charge level of the battery and charges the battery accordingly with the required current and voltage based on battery temperature and voltage. This ensures maximum battery life charge it fully before storage.

A **flashing red LED** light on the charger indicates that the battery temperature is not within the charging temperature range of -5 °C– 50 °C or the charging current is too high. As soon as the permitted temperature and the charging current ranges are reached, the battery charger will automatically switch to charging.

After continuous or repeated charging cycles without interruption, the charger may warm up. This is normal and does not indicate a technical defect of the battery charger.

## Battery LED Panel

The battery is equipped with a charge-level indicator panel which indicates its' charge condition. This charge-level indicator panel consists of 4 LEDs on the battery. Press and hold the charge indicator button on the battery to actuate the charge level indicator. The charge level indicator LEDs go out after releasing the button. The battery's charge level can be checked either when the battery is fitted on the machine or removed from the machine.

LED indicators on battery	Battery Capacity
Continuous lighting of 4 LEDs (inc 2 green)	Fully charged
Continuous lighting of 3 LEDs (inc 1 green)	≥ 50%
Continuous lighting of 2 LEDs (orange & red)	≥ 25%
Continuous lighting of 1 LED (red only)	≤ 25%. Recharge required.

# Maintenance

## General Maintenance



**Always wear gardening gloves when handling or working near sharp blades.**



**Switch off, remove the isolator key, battery and grass collector before adjusting or cleaning.**



**NOTE!** To ensure long and reliable product life, carry out the following maintenance regularly:

- Check for obvious defects such as loose, dislodged or damaged blade, loose fixings, and worn or damaged components.
- Check that covers and guards are undamaged and correctly fitted.
- Carry out necessary maintenance or repairs before using. Repairs should only be carried out by a qualified service agent.

## Battery Maintenance

The following maintenance will ensure a long battery life:

- Protect the battery against moisture and water. Store in a cool dry environment.
- Store the battery only within a temperature range between 0 °C and 25 °C. For example, do not leave the battery in a car in summer.
- Do not leave the battery in the product in direct sunlight.
- The ideal storage condition for the battery is 0 °C ~ 25 °C.
- Occasionally clean the venting slots of the battery using a soft, clean and dry brush.
- A significantly reduced battery working time after a full charge indicates that the battery is worn and should be replaced.

# Maintenance

## Blade Maintenance

13

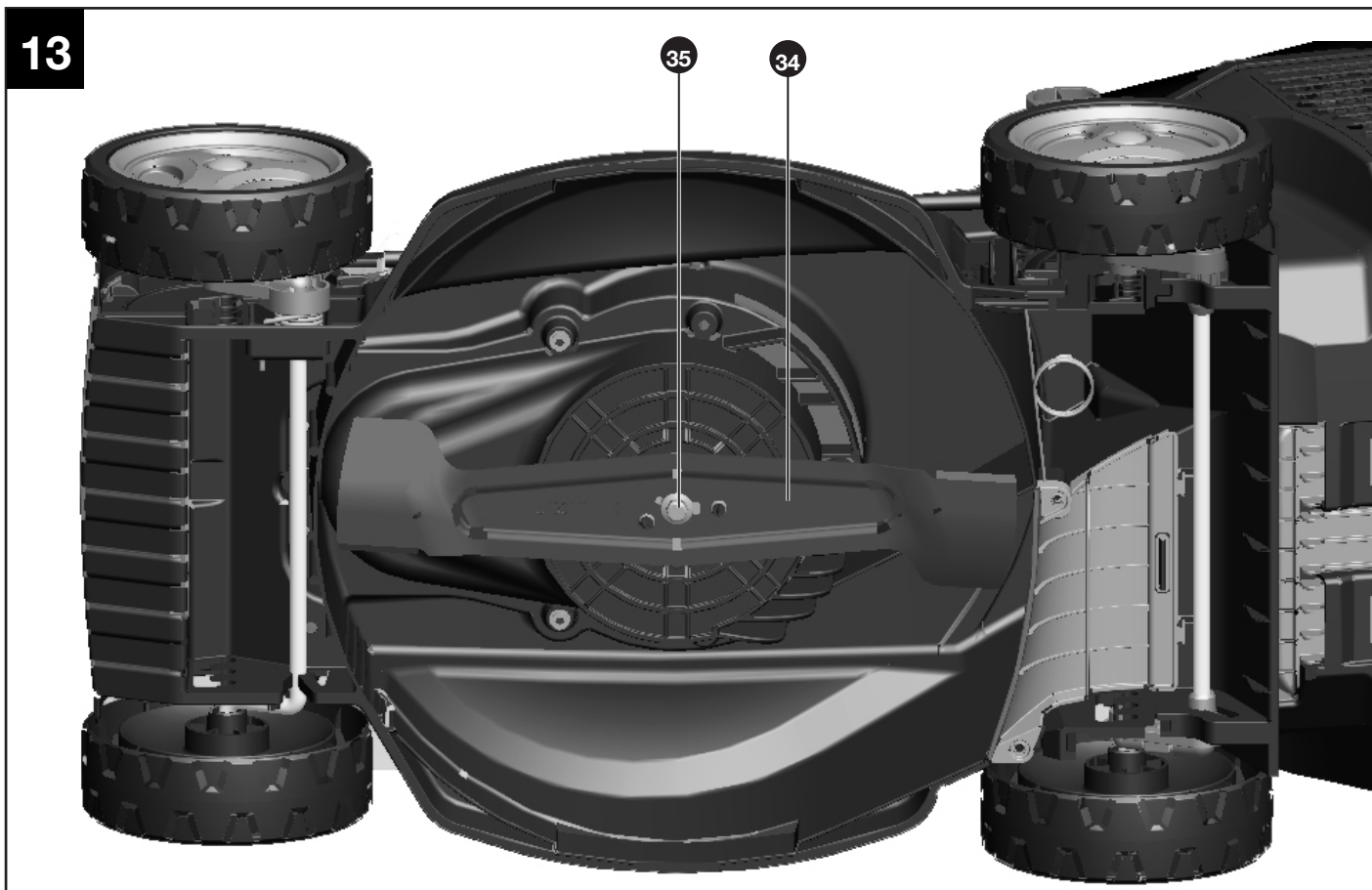

Turn the machine carefully onto its right side and inspect the blade. If blunt or damaged, replace it.

Use the following procedure to remove and replace the blade:

Wear thick gardening gloves. Hold the blade and using a spanner (not provided) loosen the blade bolt and remove the blade. Fit the new blade and the blade bolt. Ensure that the blade is the correct way up (so that the blade number can be seen.) and tighten the bolt securely.

If the blade is difficult to remove or fit, insert a screwdriver into the hole to help prevent blade rotation. Ensure the screwdriver is removed before attempting to turn the machine on.



**Do not lubricate blade or blade bolt during refitting.**

# Troubleshooting

## General Troubleshooting

The following table provides solutions to common problems encountered with the mower.

<b>Fault</b>	<b>Possible Cause</b>	<b>Solution</b>
Mower fails to operate	Possible clogging	Check underneath the mower and clear as necessary (always wear gardening gloves)
	Battery not fully charged	Charge battery
	Battery not inserted (properly)	Ensure battery is correctly inserted
	Grass too long	Increase height of cut and tilt garden product to reduce starting load
	Battery too hot/cold	Allow to cool/warm
	Isolator key not inserted correctly/fully	Fit key correctly
	There is a short delay in the motor starting after engaging the On/Off switch	This is normal. Hold On/Off switch for 1– 3secs to start motor.
Motor starts and stops immediately	Battery not fully charged	Charge battery
	Isolator key not inserted correctly/fully	Fit correctly
	Battery not inserted (properly)	Ensure battery is correctly inserted
	Battery too hot/cold	Allow to cool/warm Increase height of cut
Garden product functions intermittently	Internal wiring of garden product damaged	Contact a service agent/ helpline
	Motor protector has activated	Allow motor to cool and increase height of cut
Lawnmower leaves ragged cut	Height of cut too low	Increase height of cut
	Cutting blade blunt	Replace the blade
Poor cutting or motor labours	Possible clogging	Check underneath the mower and clear out as necessary (always thick gardening gloves)
	Blade fitted upside down	Refit blade correctly
Area of cut (battery duration) not large enough	Height of cut too low	Increase height of cut and walk slower
	Grass too high	Increase height of cut and walk slower
	Grass wet or damp	Wait until grass is dry and walk slower
	Grass is dense	Increase height of cut, walk slower and cut more frequently

# Troubleshooting

## General Troubleshooting (continued)

The following table provides solutions to common problems encountered with the mower.

<b>Fault</b>	<b>Possible Cause</b>	<b>Solution</b>
Cutting blade not rotating while garden product switched on	Cutting blade obstructed	Switch off garden product Clear obstruction (always wear gardening gloves)
	Blade nut/bolt loose	Tighten blade nut/bolt (17 Nm)
Excessive vibrations/noise	Blade nut/bolt loose	Tighten blade nut/bolt (17 Nm)
	Cutting blade damaged	Replace the blade
No charging procedure possible	Battery contacts contaminated	Clean the battery contacts (e.g. by inserting and removing the battery several times) or replace the battery
	The battery is defective, due to a disconnection in the battery (individual cells)	Replace the battery
The charge control LEDs do not light up after inserting the mains plug into the socket	Mains plug of battery charger not plugged in (properly)	Insert mains plug (fully) into the socket outlet
	Socket outlet, mains cable or battery charger defective	Check the mains voltage and if necessary, have the battery charger checked by an authorized customer service station.



# Technical Data

## Technical Data Table

Specification	Value
Cutting width	32cm
Height of cut	25/35/45/55/65mm
Grass collector capacity	33l
Speed	3400min <sup>-1</sup>
Weight	9.5kg
Charger input	220-240V~ 50Hz 145W
Rated voltage of battery	24V
Capacity of battery	4.0Ah
Charging period (battery fully discharged)	100Min
Charging current of charger	3A
Permitted charging temperature range (for charger)	-5°C~50°C
Weight of charger	0.6kg
Insulation protection of charger	<input type="checkbox"/>

## Transport

Only post or dispatch a battery if the housing is undamaged..

Tape or mask off open contacts and pack up the battery in such a manner that it cannot move around in the packaging. Pack carefully to avoid damage in transit

When dispatching lithium-ion batteries, compulsory labeling may be required. Please observe the respective national regulations.

## Disposal

### Disposal and Recycling



Do not dispose of any garden product, battery charger, battery, or recharger into household waste!

#### **Only for EC countries:**

According to the European law 2002/96/EC, electrical and electronic equipments that are no longer usable, and according to the European law 2006/66/EC, defective or used battery packs/batteries, must be collected separately and disposed of in an environmentally correct manner.

# Disposal

## Disposal and Recycling (continued)



### **Li-ion batteries:**

Please observe the instructions in section "Transport".

Do not dispose of with household waste.

Dispose of safely according to local legal requirements.

Due to a program of continuous product improvement features and instructions are liable to change without notice.

## Getting Help

**After sales helpline number: 0345 640 0800**

**Spare parts purchases: [www.argosspares.co.uk](http://www.argosspares.co.uk)**