

SOVEREIGN

Electric Grass Trimmer



N1F-GT-220/250-C

CE   **OPERATING INSTRUCTIONS**

Sep 2014 Rev B

ORIGINAL INSTRUCTIONS

INTRODUCTION

Thank you for purchasing a Sovereign grass trimmer.

We would you like to be completely satisfied with your new product and hope you will enjoy using this tool for many years.

Your Sovereign Grass Trimmer has been designed for cutting grass and similar soft vegetation and for trimming grass edges in private and hobby garden areas which are not accessible with a lawn mower.

The device is not allowed to be used in public gardens, parks, sports centres or at roadsides as well as agriculture and forestry.

GENERAL POWER TOOL SAFETY WARNINGS



WARNING!

Read all instructions. Failure to follow all instructions listed below may result in electric shock, fire and/or serious injury. The term "power tool" in all warnings listed below refers to your mains operated power tool.

1. **Read the instruction carefully.** Be familiar with the controls and the proper use of the appliance. Read and understand the operator's manual and observe the warnings and instruction labels affixed to the appliance.
2. **Users.** Never allow children or people unfamiliar with these instructions to use the appliance. Local regulations may restrict the age of operator. Never operate the tool under the influence of alcohol, medication or drugs.
3. **Use appropriate tool.** This device is only intended for cutting grass and soft vegetation outdoors and only designated for use on private property. Do not force small tools or attachments to do the job of a heavy duty tool.
4. **Keep work areas clean.** Cluttered areas can cause accidents.
5. **Consider work area environment.** Do not expose your tool to high humidity or rain. Do not use your tool in damp and wet conditions. Keep the work area well lit. Do not use your tool where there is a risk of causing fire or explosion, e.g. in the presence of flammable liquids and gases.
6. **Keep all bystanders, children, and pets away.** The operator or user is responsible for accidents or hazards occurring to other people or the property.

7. **Dress appropriately.** Do not wear loose clothing or jewelry, as these can be caught in moving parts. Preferably wear non-slip footwear when working outdoors. Wear protective hair covering to keep long hair out of the way.
8. **Head protection.** Always use safety glasses and gloves. Use a face or dust mask whenever the operations may produce dust or flying particles. Wear ear protection whenever the sound level seems uncomfortable.
9. **Do not overreach.** Keep proper footing and balance at all times.
10. **Stay alert, watch what you are doing.** Use common sense when operating the appliance. Do not operate the tool when you are tired.
11. **Grip the tool securely.** Operator should one hand on the main handle, the other on the front handle. Keep finger off trigger until ready to use.
12. **Remove adjusting keys and wrenches.** Always check that adjusting keys and wrenches are removed from the tool before operating the tool.
13. **Risk of cut.** Do not touch or try to stop the cutting lines when they are moving.
14. **Disconnect the plug.** Disconnect plug from the tool when not in use or when servicing or cleaning.
15. **Check for damaged parts.** Before further use, carefully check the tool for damage. Check for alignment of moving parts, binding of moving parts, breakage of parts, mounting and any other condition that may affect its operation. Do not use the tool if any parts are damaged or defective. Have any damaged or defective parts repaired or replaced by an authorized service agent. Never attempt any repairs yourself.
16. **Avoid unintentional starting.** Do not carry the tool without disconnect the plug and be sure the tool is switched off.
17. **Use an extension cord suitable for outdoor use when operating a power tool outdoors.** Use a cord suitable for outdoor use reduces the risk of electric shocks.
18. **If operating a power tool in a damp location is unavoidable, use a residual current device (RCD) protected supply.** Use of an RCD reduces the risk of electric shock.
19. **Store idle tools.** When not in use, tools should be stored in a dry, locked-up place out

Customer Helpline 01904 727503
www.gardenservicecentre.co.uk

ORIGINAL INSTRUCTIONS

of reach of children.

20. **Maintain tools with care.** Keep tools clean and in good condition for better and safer performance. Follow the instructions for maintenance and changing accessories. Keep handles and switches dry, clean and free from oil and grease.

21. **Have your tool repaired by an authorized service agent.** This tool is manufactured in accordance with the relevant safety regulations. To avoid danger, electrical appliances must only be repaired by qualified technicians.



WARNING!

Do not use any attachments or accessories not recommended by the manufacturer of this tool. The use of attachments or accessories not recommended can result in serious personal injury.

ADDITIONAL SAFETY WARNINGS FOR YOUR GRASS TRIMMER

- a) Wear protective glasses or goggles;
- b) Never allow children or people unfamiliar with the instructions to use the machine;
- c) Stop using the machine while people, especially children, or pets are nearby;
- d) Only use the machine in daylight or good artificial light;
- e) Before using the machine and after any impact, check for signs of wear or damage and repair as necessary;
- f) Never operate the machine with damaged guards or without the guards in place;
- g) Keep hands and feet away from the cutting means at all times and especially;
- h) Take care against injury from any device fitted for trimming the filament line length. After extending new cutter line always return the machine to its normal operating position before switching on;
- i) Never fit metal cutting elements;
- j) Never use replacement parts or accessories not provided or recommended by the manufacturer;
- k) Always ensure that ventilation openings are kept clear of debris;

ELECTRICAL SAFETY



WARNING!

Read these safety instructions thoroughly before connecting this product to the mains supply.

Before switching on, make sure that the voltage of your electricity supply is the same as that indicated on the rating plate. This product is designed to operate on 230-240VAC 50Hz. Connecting it to any other power source may cause damage.

This product may be fitted with a non-rewireable plug. If it is necessary to change the fuse in the plug, the fuse cover must be refitted. If the fuse cover becomes lost or damaged, the plug must not be used until a suitable replacement is obtained.

If the plug has to be changed because it is not suitable for your socket, or due to damage, it should be cut off and a replacement fitted, following the wiring instructions shown below. The old plug must be disposed of safely, as insertion into a 13 amp socket could cause an electrical hazard.

ORIGINAL INSTRUCTIONS

DESCRIPTION OF SYMBOLS

Symbols are used in this manual to attract your attention to possible risks. The safety symbols and the explications which accompany them must be perfectly understood. The warning themselves do not prevent the risks and can not be a substitute for proper methods of avoiding accidents.



Before any use, refer to the corresponding paragraph in the present manual.



Warning!
This symbol, before a safety comment, indicates a precaution, a warning or a danger. Ignoring this warning can lead to an accident for yourself or for others. To limit the risk of injury, fire, or electrocution always apply the recommendations indicated.



Wear ear protection.



Wear eye protection.



Wear dust mask.



Do not expose and operate the tool in rain.

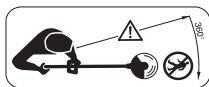

Keep all other people, including children, pet and bystanders outside the 15 meters hazard zone, stop the trimmer immediately if you are approached.



Remove the plug from the mains supply immediately if the cable is damaged or cut.



Double insulation.



Recycle unwanted materials instead of disposing of them as waste. All tools, hoses and packaging should be sorted, taken to the local recycling centre and disposed of in an environmentally safe way.

ORIGINAL INSTRUCTIONS

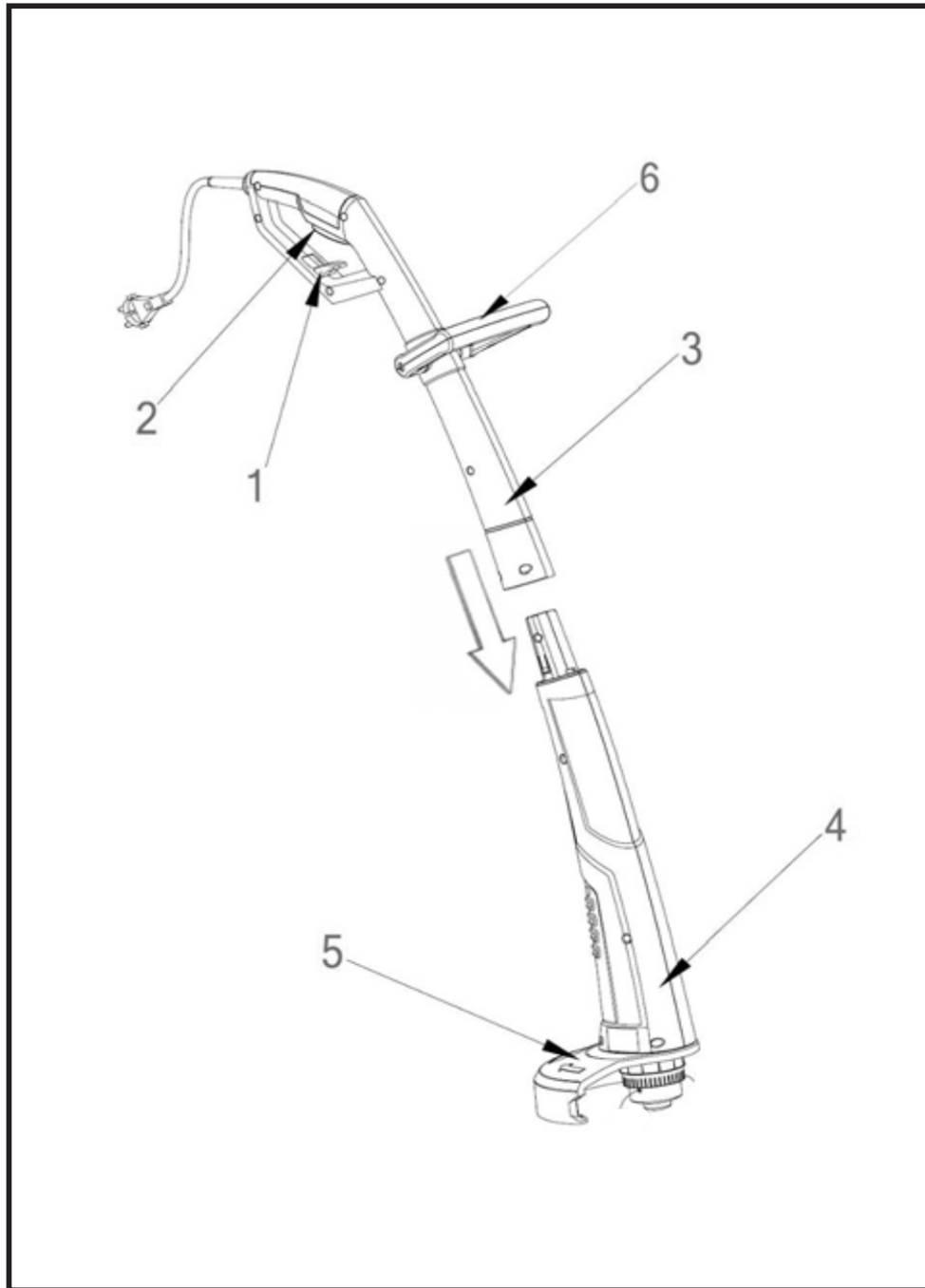

Customer Helpline **01904 727503**
www.gardenservicecentre.co.uk

ORIGINAL INSTRUCTIONS

1. Hook

2. On/off switch

3. Upper handle

4. Motor housing

5. Safety guard

6. Auxiliary handle

ORIGINAL INSTRUCTIONS

PACK CONTENTS

1. grass trimmer
2. safety guard
3. assembly screw for safety guard

EXTENSION CABLES



WARNING!

Do not use two-core extension cords or reels on power tools with an earth path.

Use only extension cords suitable for outdoor use, preferably with a high visibility cable colour. Always unwind all extension cables fully, coiled cables can overheat and reduce the efficiency of your product.

For extension cables up to 15metres , use a wire cross section of 1.5mm². For extension cables over 15 meters but less than 40 meters, use a wire cross section of 2.5 mm².

If the insulation on a power cable or extension lead is found to be cut or damaged, do not touch it! Disconnect the power supply immediately and have the damaged cable replaced.

Do not repair damaged cables.

Always follow the manufacture's instructions.

ASSEMBLY:

1. ASSEMBLY THE TRIMMER HEAD. (See below Fig.A1 A2)

Insert the trimmer head into the upper handle, making sure the handle are locked-in.

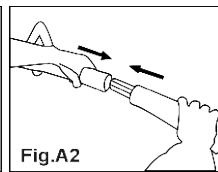
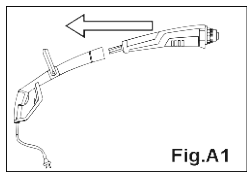

WARNING!

Do not use the product without fitting the guard.

2. ASSEMBLY THE GUARD (See Fig B.)

Push the line guard over the cutting line spool and onto the trimmer head.

Make sure that the cutting line is not trapped under the line guard.

Make sure that the sides are located into the grooves on the trimmer head.

Secure the safety guard with screw provided.

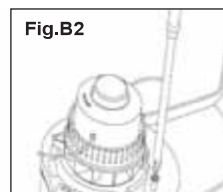
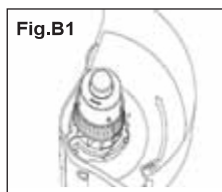

3. FITTING THE AUXILIARY HANDLE (See Fig. C1 C2)

Locate the auxiliary handle to the bracket. Take care of its orientation.

Insert the bolt through the bracket and the handle then screw into the captivated nut.

Tighten the screw with tool.

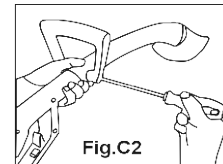
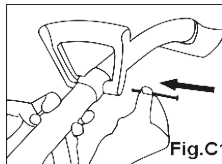

4. MAINS SUPPLY CABLE STRAIN RELIEF (See Fig. D)

To prevent excessive strain on the cable connections, the hedge trimmer is fitted with a cable restraint.

Before switching on, push a loop of cable through the space in the handle and secure it over the cable restraint.

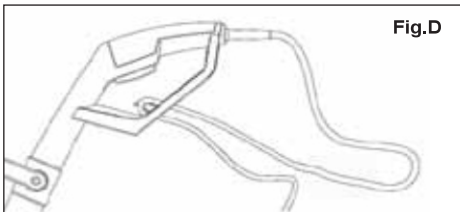

ORIGINAL INSTRUCTIONS

OPERATING THE ON/OFF SWITCH

Press the on/off switch, your switch is now on.
(See Fig. E)

To switch off, simply release the on/off switch.



! WARNING!

The cutting head continues to rotate after the trimmer has been switched off, wait until it has stopped then lay down the tool.

OPERATION

! WARNING!

Always wear eye protection. Never lean over the trimmer head. Rocks or debris can ricochet or be thrown into eyes and face and cause blindness or other serious injury.

When operating unit, check for the following:

Wear eye protection and heavy clothing.

Hold front handle with one hand and auxiliary handles with the other hand.

Keep unit below waist levels. Work only from your right to your left to ensure debris is thrown away from you.

Without bending over, keep line near and parallel to the ground (perpendicular when edging). Do not switch the machine on with the cutting head on or near material to be cut.

Ensure the cutting line is at full speed before contacting material to be cut.

! WARNING!

Make sure that line is fed out before operation. Make sure motor is up to full speed before trimming.

1. Let the trimmer run for a few seconds without touching the working area, and allow the trimmer to cut the line.
2. Use the trimmer at an angle of approximately 15 degree to the working area.
3. Swing the trimmer head from side to side.
(See Fig.F)

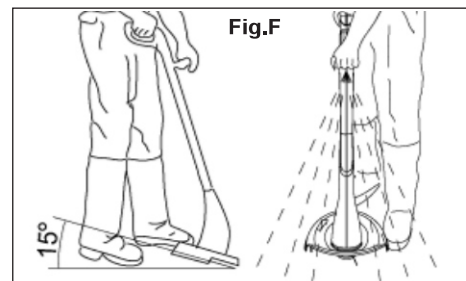

4. If the grass is very long cut in stages rather than trying to cut in one go. Do not overload your trimmer, take small cuts this will keep machine operating at high speed and will greatly improve cutting efficiency.
(See Fig. G).

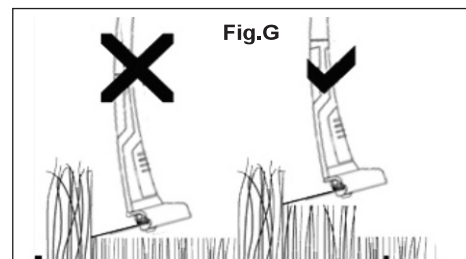

ORIGINAL INSTRUCTIONS

TO MANUALLY FEED THE LINE (See Fig.H)

If required, line can be fed out manually. To operate, press and release manual line feed button, while gently pulling out the lines until the lines reach the line cutter.

When the required amount of line is fed out, gently pull on the second line (there is no need to press the manual line feed button again), If the line extends past the line cutter, too much line has been fed out.

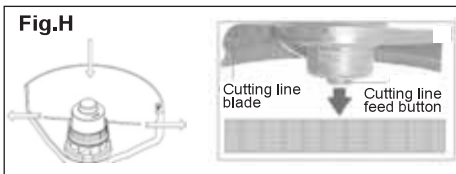

If too much line is fed out, remove the spool cap and turn spool counter-clockwise until the line is at the desired length .

TO REMOVE THE CUTTING HEAD COVER (See Fig.I1)

Press the release latch on the spool head cover and remove cover, pulling it straight off the cutting head assembly.

Pull the cutting head cover away from the spool holder.

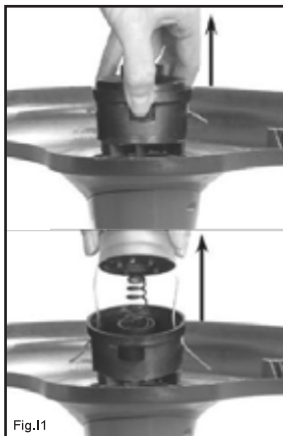

WHEN REFITTING THE SPOOL CAP (See Fig.I2)

Keep all areas of the cutting head cover and spool holder clean.

Replace the spool head cover, pressing firmly down towards the spool holder to ensure the cover is fully located.

Check that the cap is correctly fitted by trying to remove it without depressing the two latches.



TO REPLACE CUT LINE

For your convenience it is recommended you buy spool and line complete.

TO FIT SPOOL AND LINE COMPLETE

Remove old spool.

Place new spool into cutting head with cut out areas of the spool in line with eyelets.

Release line from cleat and feed line through eyelet.

Refit the spool head cover.

TO FIT NYLON LINE ONLY :

⚠ WARNING!

Take approximately 4m of line. Insert line into the spool holes and wind line in the direction of the arrows on the top of spool. (See Fig.J)

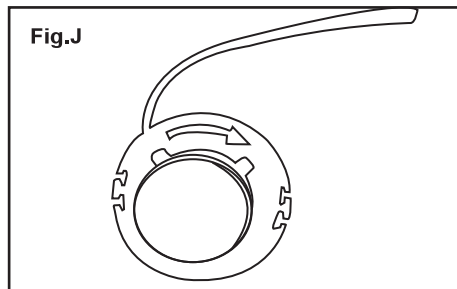

ORIGINAL INSTRUCTIONS

Your trimmer is designed to use only line with a maximum diameter of 1.2mm.

IMPORTANT:

Leave approximately 100mm of line unwound and place into cleat.

Care should be taken to ensure that the line is neatly coiled on the spool. Failure to do so will impair the efficiency of the automatic line feed. (See Fig. K1 K2 K3)

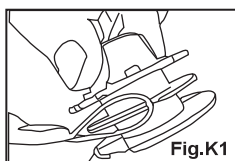

Fig.K1



Fig.K2

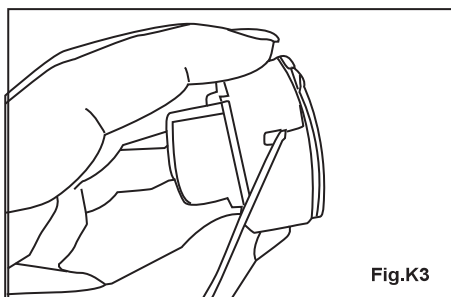

Fig.K3

Then fit spool as described in "To fit spool and line complete".

MAINTENANCE AND STORAGE

1. Never use water or chemical cleaners to clean your power tool. Wipe clean with a dry cloth.
2. Always check the cutting head and guard before each use.
3. Always store your power tool in a dry place.
4. Keep the motor ventilation slots clean.
5. Have the unit professionally repaired should any damage parts.

TROUBLE SHOOTING

Although your new grass trimmer is really easy to operate. If you do experience problems, check the following:



WARNING!

Before proceeding, unplug the tool.

Tool runs slowly

- Check that the spool housing can rotate freely. Carefully clean it if necessary.
- Check that the cutting line does not protrude more than 9 cm from the spool housing. If it does, cut it off so that it just reaches the line trimming blade.

If the trimmer is not cutting properly

Check the condition of the cutting head, if the cutting line is too short or cutting head damaged. Note: Do not use damaged cutting head.

If a fault is suspected return the trimmer to an authorized dealer for repair.

Customer Helpline **01904 727503**
www.gardenservicecentre.co.uk

ORIGINAL INSTRUCTIONS

TECHINICAL DATA

Model No.	N1F-GT-220/250-C
Rated voltage	230-240V AC 50Hz
Input power	250W
No load speed	12000rpm
Cutting Width	220MM
Cutting line Diameter	1.2mm
Protection class	II
Machine Weight	2.1kg

NOISE AND VIBRATION DATA

Sound pressure level(LpA)	88dB(A), K _{PA} : 1,5dB(A)	
Power sound level(LwA)	95dB(A)	
Vibrations	2,7m/s ² , K: 1,5m/s ²	

ORIGINAL INSTRUCTIONS

WARNING!

The vibration emission value during actual use of the power tool can differ from the declared value depending on the ways in which the tool is used dependant on the following examples and other variations on how the tool is used:

How the tool is used and the materials is cut or drilled.

The tool being in good condition and well maintained.

The use the correct accessory for the tool and ensuring it is sharp and in good condition.

The tightness of the grip on the handles and any anti vibration accessories are used.

And the tool is being used as intended by its design and these instructions.

This tool may cause hand vibration syndrome if tie use is not adequately managed.

PLUG REPLACEMENT

Your grass trimmer is fitted with a moulded plug. However if you need to replace a fitted plug then follow the instructions below.

IMPORTANT

The wires in the mains lead are coloured in accordance with the following code:

Blue - Neutral Brown – Live

As the colours of the wires in the mains lead of this appliance may not correspond with the coloured markings identifying the terminals in your plug, proceed as follows.

The wire which is coloured blue must be connected to the terminal which is marked with N

The wire which is coloured brown must be connected to the terminal which is marked with the letter L

If a 13AMP (BS1363/A) plug is used, a 13A fuse must be fitted, or if any other type of plug is used a 13AMP fuse must be fitted, either in the plug or adapter, or on the distribution board.

Note: If a moulded plug is fitted and has to be removed take great care in disposing of the plug and severed cable, it must be destroyed to prevent engaging into a socket. If the supply cord is damaged it must be replaced by a service agent or a similarly qualified person in order to avoid hazard.

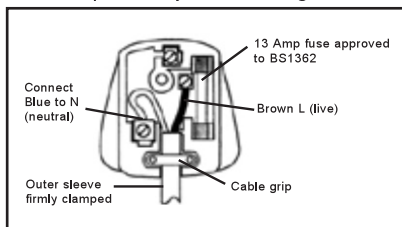

ENVIRONMENTAL PROTECTION



Waste electrical products should not be disposed of with household waste. Please recycle where facilities exist. Check with your local authority or retailer for recycling advices.

GUARANTEE

This product is selected for **DOMESTIC USE ONLY** and not for business use. This product is guaranteed against manufacturing defects for a period of 12 months. This does not cover the product where the fault is due to misuse, abuse, use in contravention of the instructions, or where the product has been the subject of unauthorised modifications or alterations, or has been the subject of commercial use. In the event of a problem with the product within the guarantee period please return it to your nearest store. If the item is shown to have an inherent defect present at the time of sale, the store will provide you with a replacement. Your statutory rights remain unaffected.

Customer Helpline **01904 727503**
www.gardenservicecentre.co.uk