



# **iP8700 series**

# **Online Manual**

Read Me First  
Useful Functions Available on the Printer  
Overview of the Printer  
Printing  
Troubleshooting

# Contents

Read Me First. . . . .	12
How to Use the Online Manual. . . . .	13
Trademarks and Licenses. . . . .	14
Search Tips. . . . .	15
Notes on Operation Explanations. . . . .	17
Useful Functions Available on the Printer. . . . .	18
Useful Functions Available from Applications and the Main Unit. . . . .	19
Helpful Functions Available Through the Network. . . . .	23
Printing with Google Cloud Print. . . . .	25
Preparations for Printing with Google Cloud Print. . . . .	26
Printing from Computer or Smartphone with Google Cloud Print. . . . .	29
Using Remote UI. . . . .	31
Printing from AirPrint Compliant Device. . . . .	34
Overview of the Printer. . . . .	39
Safety Guide. . . . .	40
Safety Precautions. . . . .	41
Regulatory and Safety Information. . . . .	42
Main Components and Basic Operations. . . . .	46
Main Components. . . . .	47
Front View. . . . .	48
Rear View. . . . .	50
Inside View. . . . .	51
About the Power Supply of the Printer. . . . .	52
Confirming that the Power Is On. . . . .	53
Turning the Printer On and Off. . . . .	54
Notice for the Power Plug/Power Cord. . . . .	56
Notice for Unplugging the Power Cord. . . . .	57
Loading Paper. . . . .	58
Loading Paper. . . . .	59
Loading Plain Paper / Photo Paper. . . . .	60
Loading Envelopes. . . . .	63
Media Types You Can Use. . . . .	66

Paper Load Limit. . . . .	69
Media Types You Cannot Use. . . . .	71
Before Printing on Art Paper. . . . .	72
Printing Area. . . . .	74
Printing Area. . . . .	75
Other Sizes than Letter, Legal, Envelopes. . . . .	76
Letter, Legal. . . . .	77
Sizes for Art Paper. . . . .	78
Envelopes. . . . .	80
Printable Discs. . . . .	81
Placing a Printable Disc. . . . .	82
Cautions When Printing on a Printable Disc. . . . .	83
Before Placing a Printable Disc. . . . .	84
Placing a Printable Disc. . . . .	85
Removing a Printable Disc. . . . .	87
Replacing an Ink Tank. . . . .	89
Replacing an Ink Tank. . . . .	90
Checking the Ink Status. . . . .	95
Checking the Ink Status with the Ink Lamps. . . . .	96
Maintenance. . . . .	98
When Printing Becomes Faint or Colors Are Incorrect. . . . .	99
Maintenance Procedure. . . . .	100
Printing the Nozzle Check Pattern. . . . .	102
Examining the Nozzle Check Pattern. . . . .	103
Cleaning the Print Head. . . . .	104
Aligning the Print Head. . . . .	105
Performing Maintenance from a Computer. . . . .	106
Cleaning the Print Heads from Your Computer. . . . .	107
Cleaning the Paper Feed Rollers from Your Computer. . . . .	109
Aligning the Print Head. . . . .	110
Aligning the Print Head Position from Your Computer. . . . .	111
Aligning the Print Head Position Manually from Your Computer. . . . .	112
Use Your Computer to Print a Nozzle Check Pattern. . . . .	116
Cleaning Inside the Printer. . . . .	117
Cleaning the Printer. . . . .	118
Cleaning the Exterior of the Printer. . . . .	119
Cleaning the Inside of the Printer (Bottom Plate Cleaning). . . . .	120

<b>Changing the Printer Settings.</b> . . . . .	<b>122</b>
Changing Printer Settings from Your Computer. . . . .	123
Changing the Print Options. . . . .	124
Registering a Frequently Used Printing Profile. . . . .	125
Managing the Printer Power. . . . .	127
Reducing the Printer Noise. . . . .	129
Changing the Printer Operation Mode. . . . .	131
Initializing the Printer Settings. . . . .	133
<b>Information about Network Connection.</b> . . . . .	<b>134</b>
Useful Information about Network Connection. . . . .	135
Initial Values Set at Factory (Network). . . . .	136
Connecting the Printer to the Computer Using a USB Cable. . . . .	137
When Detecting the Printers Have the Same Name during Setup. . . . .	138
Connecting to Other Computer with LAN/Changing the Connection Method from USB to LAN. . . . .	139
Printing Out Network Setting Information. . . . .	140
<b>About Network Communication.</b> . . . . .	<b>142</b>
Changing and Confirming Network Settings. . . . .	143
IJ Network Tool. . . . .	144
Changing the Settings in the Wireless LAN Sheet. . . . .	145
Changing the WEP Detailed Settings. . . . .	147
Changing the WPA or WPA2 Detailed Settings. . . . .	149
Changing the Settings in the Wired LAN Sheet. . . . .	152
Changing the Settings in the Admin Password Sheet. . . . .	153
Monitoring Wireless Network Status. . . . .	154
Initializing the Network Settings of the Machine. . . . .	157
Viewing the Modified Settings. . . . .	158
Screens for Network Connection of IJ Network Tool. . . . .	159
Canon IJ Network Tool Screen. . . . .	160
Configuration Screen. . . . .	163
Wireless LAN Sheet. . . . .	164
Search Screen. . . . .	166
WEP Details Screen. . . . .	168
WPA Details Screen. . . . .	169
WPA2 Details Screen. . . . .	170
Authentication Type Confirmation Screen. . . . .	171
PSK: Passphrase and Dynamic Encryption Setup Screen. . . . .	172
Setup Information Confirmation Screen. . . . .	173

Wired LAN Sheet. . . . .	174
Admin Password Sheet. . . . .	175
Network Information Screen. . . . .	176
Access Control Sheet. . . . .	177
Edit Accessible MAC Address Screen/Add Accessible MAC Address Screen. . . . .	181
Edit Accessible IP Address Screen/Add Accessible IP Address Screen. . . . .	182
Other Screens of IJ Network Tool. . . . .	183
Canon IJ Network Tool Screen. . . . .	184
Status Screen. . . . .	187
Connection Performance Measurement Screen. . . . .	188
Maintenance Screen. . . . .	190
Network Setup of the Card Slot Screen. . . . .	191
Associate Port Screen. . . . .	193
Network Information Screen. . . . .	194
Appendix for Network Communication. . . . .	195
Using the Card Slot over a Network. . . . .	196
When the Printer Driver Is Not Associated with a Port. . . . .	198
About Technical Terms. . . . .	199
Restrictions. . . . .	205
About Firewall. . . . .	206
Tips for Ensuring Optimal Printing Quality. . . . .	207
Useful Information about Ink. . . . .	208
Key Points to Successful Printing. . . . .	210
Be Sure to Make Paper Settings after Loading Paper. . . . .	211
Canceling a Print Job. . . . .	212
Printer Handling Precautions. . . . .	213
Key to Enjoying Consistent Printing Quality. . . . .	214
Precautions for Safe Transport of the Printer. . . . .	215
Legal Limitations on Use of Your Product and Use of Images. . . . .	216
Specifications. . . . .	217
Printing. . . . .	220
Printing from a Computer. . . . .	221
Printing with Application Software that You are Using (Printer Driver). . . . .	222
Printing with Easy Setup. . . . .	223
Setting the Media Type with the Printer Driver. . . . .	225
Various Printing Methods. . . . .	226

Setting a Page Size and Orientation. . . . .	227
Setting the Number of Copies and Printing Order. . . . .	228
Setting the Stapling Margin. . . . .	230
Execute Borderless Printing. . . . .	232
Fit-to-Page Printing. . . . .	235
Scaled Printing. . . . .	237
Page Layout Printing. . . . .	240
Tiling/Poster Printing. . . . .	242
Booklet Printing. . . . .	245
Duplex Printing. . . . .	247
Stamp/Background Printing. . . . .	249
Registering a Stamp. . . . .	252
Registering Image Data to be Used as a Background. . . . .	255
Setting Up Envelope Printing. . . . .	258
Printing on Postcards. . . . .	260
Displaying the Print Results before Printing. . . . .	262
Setting Paper Dimensions (Custom Size). . . . .	263
Editing the Print Document or Reprinting from the Print History. . . . .	265
Changing the Print Quality and Correcting Image Data. . . . .	268
Setting the Print Quality Level (Custom). . . . .	269
Printing a Color Document in Monochrome. . . . .	271
Adjusting Tone. . . . .	273
Specifying Color Correction. . . . .	275
Optimal Photo Printing of Image Data. . . . .	277
Adjusting Colors with the Printer Driver. . . . .	278
Printing with ICC Profiles. . . . .	280
Interpreting the ICC Profile. . . . .	283
Adjusting Color Balance. . . . .	284
Adjusting Color Balance Using Sample Patterns (Printer Driver). . . . .	286
Adjusting Brightness. . . . .	290
Adjusting Intensity. . . . .	292
Adjusting Contrast. . . . .	294
Adjusting Intensity/Contrast Using Sample Patterns (Printer Driver). . . . .	296
Overview of the Printer Driver. . . . .	300
Canon IJ Printer Driver. . . . .	301
How to Open the Printer Driver Setup Window. . . . .	302
Canon IJ Status Monitor. . . . .	303
Checking the Ink Status from Your Computer. . . . .	304
Canon IJ Preview. . . . .	305

Deleting the Undesired Print Job. . . . .	306
Instructions for Use (Printer Driver). . . . .	307
Printer Driver Description. . . . .	309
Quick Setup tab Description. . . . .	310
Main tab Description. . . . .	316
Page Setup tab Description. . . . .	322
Maintenance tab Description. . . . .	334
Canon IJ Preview Description. . . . .	341
Canon IJ XPS Preview Description. . . . .	344
Canon IJ Status Monitor Description. . . . .	353
Updating the Printer Driver. . . . .	356
Obtaining the Latest Printer Driver. . . . .	357
Deleting the Unnecessary Printer Driver. . . . .	358
Before Installing the Printer Driver. . . . .	359
Installing the Printer Driver. . . . .	360
Printing from a Digital Camera. . . . .	361
Printing Photographs Directly from a PictBridge (Wireless LAN) Compliant Device. . . . .	362
About PictBridge (Wireless LAN) Print Settings. . . . .	364
<b>Troubleshooting. . . . .</b>	<b>366</b>
<b>Problems with Network Communication. . . . .</b>	<b>367</b>
Problems with the Printer While Using with Network. . . . .	368
The Printer Stopped Working Suddenly. . . . .	369
Ink Remaining Level Is Not Displayed on Printer Status Monitor of the Printer. . . . .	371
Printing Speed Is Slow. . . . .	372
Cannot Use the Printer on Replacing an Access Point or Changing Its settings. . . . .	373
Cannot Detect a Printer on a Network. . . . .	374
Cannot Detect the Printer When Setting up Network Communication. . . . .	375
Cannot Detect the Printer during Wireless LAN Setup: Check 1. . . . .	376
Cannot Detect the Printer during Wireless LAN Setup: Check 2. . . . .	377
Cannot Detect the Printer during Wireless LAN Setup: Check 3. . . . .	378
The Printer Cannot Be Detected in the Wireless LAN. . . . .	379
Other Problems with Network. . . . .	381
Forgot an Access Point Name, SSID, or a Network Key. . . . .	382
The Message Is Displayed on the Computer Screen During Setup. . . . .	383
The Admin Password Set to the Printer Was Forgotten. . . . .	384
Checking Information about the Network. . . . .	385

How to Restore the Printer's Network Settings to Factory Default. . . . .	387
<b>Problems with Printing. . . . .</b>	<b>388</b>
Printing Does Not Start. . . . .	389
Paper Jams. . . . .	392
Paper Does Not Feed Properly/"No Paper" Error Occurs. . . . .	393
Cannot Print on the Disc Label. . . . .	396
Printing Stops Before It Is Completed. . . . .	397
<b>Problems with Printing Quality. . . . .</b>	<b>398</b>
Print Results Not Satisfactory. . . . .	399
Cannot Print to End of Job. . . . .	400
No Printing Results/Printing Is Blurred/Colors Are Wrong/White Streaks. . . . .	401
Lines Are Misaligned. . . . .	403
Line Does Not Print or Prints Partially. . . . .	404
Image Does Not Print or Prints Partially. . . . .	405
Printed Paper Curls or Has Ink Blots. . . . .	406
Paper Is Smudged/Printed Surface Is Scratched. . . . .	407
Back of the Paper Is Smudged. . . . .	410
Vertical Lines Are Printed on the Sides of the Printout. . . . .	411
Colors Are Uneven or Streaked. . . . .	412
Ink Is Not Ejected. . . . .	414
<b>Problems with the Printer. . . . .</b>	<b>415</b>
The Printer Cannot Be Powered On. . . . .	416
The Printer Turns Off Unintentionally. . . . .	417
Cannot Connect to Computer with a USB Cable Properly. . . . .	418
Cannot Communicate with the Printer with USB Connection. . . . .	419
Print Head Holder Does Not Move to the Position for Replacing. . . . .	420
Printer Status Monitor Is Not Displayed. . . . .	421
<b>Problems with Installation/Downloading. . . . .</b>	<b>422</b>
Cannot Install the Printer Driver. . . . .	423
Easy-WebPrint EX Does Not Start Up or Easy-WebPrint EX Menu Does Not Appear. . . . .	425
How to Update Printer Driver in Network Environment. . . . .	426
Uninstalling IJ Network Tool. . . . .	427
<b>About Errors/Messages Displayed. . . . .</b>	<b>428</b>
If an Error Occurs. . . . .	429
A Message Is Displayed. . . . .	432
Error Message Appears on a PictBridge (Wireless LAN) Compliant Device. . . . .	437
<b>If You Cannot Resolve the Problem. . . . .</b>	<b>439</b>



Support Code List. . . . .	440
Support Code List (When Paper Is Jammed). . . . .	442
1300. . . . .	443
Paper Is Jammed inside the Printer. . . . .	445
In Other Cases. . . . .	448
1000. . . . .	450
1001. . . . .	451
1002. . . . .	452
1200. . . . .	453
1250. . . . .	454
1401. . . . .	455
1403. . . . .	456
1405. . . . .	457
1410. . . . .	458
1411. . . . .	459
1412. . . . .	460
1413. . . . .	461
1414. . . . .	462
1415. . . . .	463
1600. . . . .	464
1660. . . . .	465
1680. . . . .	466
1681. . . . .	467
1683. . . . .	468
1684. . . . .	469
1688. . . . .	470
1700. . . . .	471
1701. . . . .	472
1830. . . . .	473
1850. . . . .	474
1851. . . . .	475
1855. . . . .	476
1856. . . . .	477
1857. . . . .	478

1858.	479
2100.	480
2101.	481
2102.	482
2103.	483
2500.	484
4100.	485
4103.	486
5100.	487
5101.	488
5200.	489
5400.	490
5700.	491
5B00.	492
5B01.	493
5C00.	494
5C20.	495
6000.	496
6001.	497
6500.	498
6502.	499
6800.	500
6801.	501
6900.	502
6901.	503
6902.	504
6910.	505
6911.	506
6930.	507
6931.	508
6932.	509
6933.	510
6940.	511
6941.	512

6942.....	513
6943.....	514
6944.....	515
6945.....	516
6946.....	517
6A80.....	518
6A81.....	519
6A90.....	520
B200.....	521
C000.....	522

# Read Me First

➔ [Notes on Online Manual Usage](#)

➔ [How to Print](#)

## Notes on Online Manual Usage

- Reproduction, diversion or copying of any text, photo or image published in the *Online Manual* (hereinafter referred to as "this guide"), in whole or in part, is prohibited.
- In principle, Canon shall change or delete the contents of this guide without prior notice to customers. In addition, Canon may suspend or stop the disclosure of this guide due to unavoidable reasons. Canon shall not be liable for any damage suffered by customers as a result of changes in or deletion of information in this guide, or suspension/stoppage of disclosure of this guide.
- Although the contents of this guide have been prepared with utmost care, please contact the service center if you find any incorrect or missing information.
- In principle, the descriptions in this guide are based on the product at the time of its initial sale.
- This guide does not disclose the manuals of all the products sold by Canon. See the manual supplied with the product when using a product that is not described in this guide.

## How to Print

Use the print function of your Web browser to print this guide.

To set to print background colors and images, follow the steps below.

### ➤➤ Note

- In Windows 8, print in the desktop version.

#### • In Internet Explorer 9 or 10

1. Select  (Tools) > **Print** > **Page setup...**
2. Select the **Print Background Colors and Images** checkbox.

#### • In Internet Explorer 8

1. Press the Alt key to display the menus.  
Alternatively, from **Tools**, select **Toolbars** > **Menu Bar** to display the menus.
2. Select **Page Setup...** from the **File** menu.
3. Select the **Print Background Colors and Images** checkbox.

#### • In Mozilla Firefox

1. Press the Alt key to display the menus.  
Alternatively, click **Firefox**, then select **Menu Bar** from the right arrow of **Options** to display the menus.
2. Select **Page Setup...** from the **File** menu.
3. Select the **Print Background (colors & images)** checkbox in **Format & Options**.

# How to Use the Online Manual

## Symbols Used in This Document

### **Warning**

Instructions that, if ignored, could result in death or serious personal injury caused by incorrect operation of the equipment. These must be observed for safe operation.

### **Caution**

Instructions that, if ignored, could result in personal injury or material damage caused by incorrect operation of the equipment. These must be observed for safe operation.

### **Important**

Instructions including important information. To avoid damage and injury or improper use of the product, be sure to read these indications.

### **Note**

Instructions including notes for operation and additional explanations.

### **Basic**

Instructions explaining basic operations of your product.

### **Note**

- 
- Icons may vary depending on your product.
- 

## Touch-enabled Device Users

For touch actions, you need to replace "right-click" in this document with the action set on the operating system. For example, if the action is set to "press and hold" on your operating system, replace "right-click" with "press and hold."

## Trademarks and Licenses

- Microsoft is a registered trademark of Microsoft Corporation.
- Windows is a trademark or registered trademark of Microsoft Corporation in the U.S. and/or other countries.
- Windows Vista is a trademark or registered trademark of Microsoft Corporation in the U.S. and/or other countries.
- Internet Explorer is a trademark or registered trademark of Microsoft Corporation in the U.S. and/or other countries.
- Mac, Mac OS, AirPort, Safari, Bonjour, iPad, iPhone and iPod touch are trademarks of Apple Inc., registered in the U.S. and other countries. AirPrint and the AirPrint logo are trademarks of Apple Inc.
- IOS is a trademark or registered trademark of Cisco in the U.S. and other countries and is used under license.
- Google Cloud Print, Google Chrome, Android, Google Play and Picasa are either registered trademarks or trademarks of Google Inc.
- Adobe, Photoshop, Photoshop Elements, Lightroom, Adobe RGB and Adobe RGB (1998) are either registered trademarks or trademarks of Adobe Systems Incorporated in the United States and/or other countries.
- Photo Rag is a trademark of Hahnemühle FineArt GmbH.
- Bluetooth is a trademark of Bluetooth SIG, Inc., U.S.A. and licensed to Canon Inc.

### Note

- The formal name of Windows Vista is Microsoft Windows Vista operating system.

Enter keywords in the search window and click  (Search).

You can search for target pages in this guide.

Entry example: "(your product's model name) load paper", "(your product's model name) 1000"

## Search Tips

You can search for target pages by entering keywords in the search window.

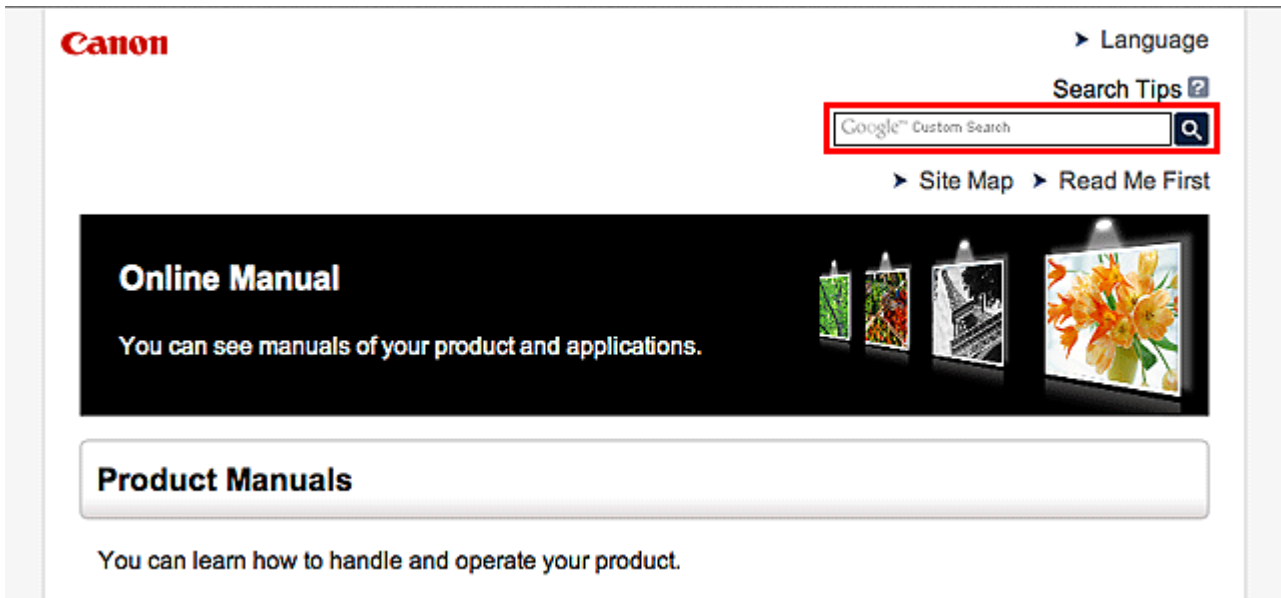

### ▶▶▶ Note

- The displayed screen may vary.

- **Searching for Functions**

Enter your product's model name and a keyword for the function you want to learn about

Example: When you want to learn how to load paper

Enter "(your product's model name) load paper" in the search window and perform a search

- **Troubleshooting Errors**

Enter your product's model name and a support code

Example: When the following error screen appears

Enter "(your product's model name) 1000" in the search window and perform a search

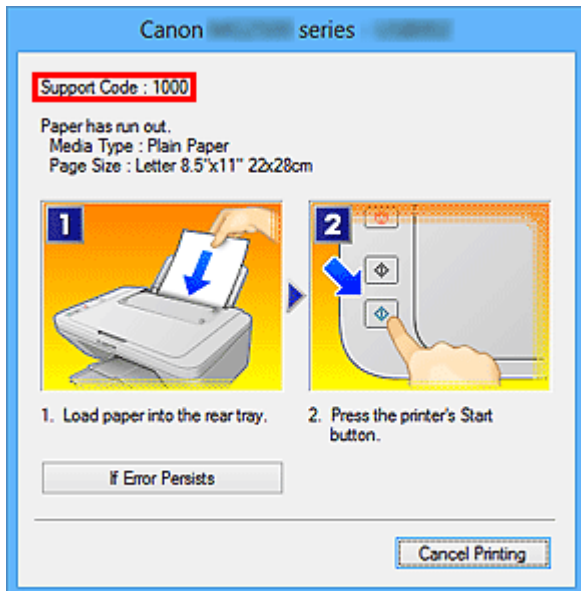

### ►►► Note

- The displayed screen varies depending on your product.

#### • Searching for Application Functions

Enter your application's name and a keyword for the function you want to learn about

Example: When you want to learn how to print collages with My Image Garden

Enter "My Image Garden collage" in the search window and perform a search

#### • Searching for Reference Pages

Enter your model name and a reference page title\*

\* You can find reference pages more easily by entering the function name as well.

Example: When you want to browse the page referred to by the following sentence on a scanning procedure page

Refer to "Color Settings Tab" for your model from Home of the *Online Manual* for details.

Enter "(your product's model name) scan Color Settings Tab" in the search window and perform a search



## Notes on Operation Explanations

In this guide, most of the operations are described based on the windows displayed when Windows 8 operating system (called Windows 8 below) is used.

## Useful Functions Available on the Printer

The following useful functions are available on the printer.  
Enjoy pleasant photography experience by utilizing various functions.

### ▶ Helpful Functions Available Through the Network



You can print more conveniently through integration with smartphones and other devices or with services on the web.

### ▶ Useful Functions Available from Applications and the Main Unit



You can create items such as collages easily or download delightful printing materials, and print them.

## Useful Functions Available from Applications and the Main Unit

On the printer, the following useful functions are available from applications and the main unit.

- [Print Photos Easily](#)
- [Print Disc Labels \(CD/DVD/BD\)](#)
- [Download Content Materials](#)
- [Print Photos on Facebook](#)

### Print Photos Easily Using an Application

#### Organize Images Easily

In My Image Garden, you can register the names of people and events to photos.

You can organize photos easily as you can display them not only by folder but also by calendar, event, and person. This also allows you to find the target photos easily when you search for them later on.

<Calendar View>



<People View>

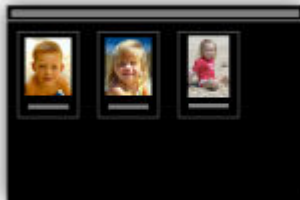

#### Display Recommended Items in Slide Shows

Based on the information registered to photos, Quick Menu automatically selects the photos on your computer and creates recommended items such as collages and cards. The created items appear in slide shows.



If there is an item you like, you can easily print it in just two steps.

1. In Image Display of Quick Menu, select the item you want to print.
2. Print the item with My Image Garden.



## Place Photos Automatically

Delightful items are created easily as the selected photos are placed automatically according to the theme.



## Other Various Functions

My Image Garden has many other useful functions.

Refer to "What You Can Do with My Image Garden" for details.

## Create and Print Personalized Disc Labels (CD/DVD/BD) Easily and Beautifully

### Create Items with Applications and Print Them

Use My Image Garden to combine your favorite photos with preset themes to create and print personalized disc labels.

Refer to "Printing Disc Labels (CD/DVD/BD)" for details.



## Download a Variety of Content Materials

### CREATIVE PARK

A "printing materials site" where you can download all the printing materials for free.

Various types of content such as seasonal cards and paper crafts that can be made by assembling paper parts are provided.

It is easily accessible from Quick Menu.

### CREATIVE PARK PREMIUM

A service where customers using models that support PREMIUM Contents can download exclusive printing materials.

PREMIUM Contents can be downloaded easily via My Image Garden. Downloaded PREMIUM Contents can be printed directly with My Image Garden.

To download PREMIUM Contents, make sure that genuine Canon ink tanks/ink cartridges are installed for all colors on a supported printer.



## ►► Note

- The designs of PREMIUM Contents provided in this page are subject to change without prior notice.

### Print Photos on Facebook Easily Using a Facebook App "Print Your Days"

Use Print Your Days to collect Facebook photos of memories of parties and travel, recent activity of your family and friends, your hobbies, etc., then create and print a work of art.

Print Your Days is available from the Print Your Days Facebook page.



## Helpful Functions Available Through the Network

The following useful functions are available on the machine.

Enjoy even more pleasant photography experience by utilizing various functions.

- ➔ [Print by using Google Cloud Print](#)
- ➔ [Print directly from your iPad, iPhone, or iPod touch](#)
- ➔ [Manage your printer from a remote location by using Remote UI](#)
- ➔ [Print easily from your smartphone by using PIXMA Printing Solutions](#)
- ➔ [Printing with Windows RT](#)

### Print in Various Environments with Google Cloud Print

The machine is compatible with Google Cloud Print (Google Cloud Print is a service provided by Google Inc.).

By using Google Cloud Print, you can print from anywhere with applications or services supporting Google Cloud Print.

Refer to "[Printing with Google Cloud Print](#)" for details.

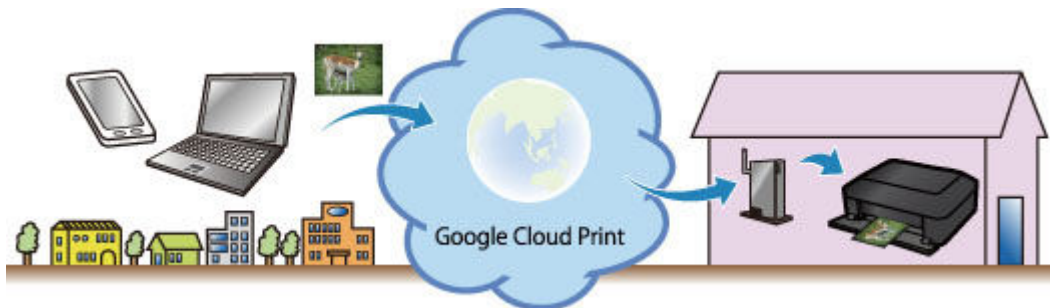

### Print Directly from iPad, iPhone, or iPod touch with Apple AirPrint

The machine is compatible with the AirPrint function of Apple iOS devices.

You can directly print e-mails, photos, web pages, etc. from iPad, iPhone, or iPod touch to the machine over wireless LAN.

Refer to "[Printing from AirPrint Compliant Device](#)" for details.



### Manage your printer from a remote location by using Remote UI

By using **Remote UI**, you can set up this machine, check the machine status, and even perform maintenance from your computer or smartphone.

Because you can use this service from a remote location through the network, you can check printer information even when you're out away from the printer.

Refer to "[Using Remote UI](#)" for details.

## **Print Easily from a Smartphone with PIXMA Printing Solutions**

Use PIXMA Printing Solutions to easily print photos saved on a smartphone wirelessly.

You can also receive scanned data (PDF or JPEG) directly on a smartphone without using a computer.

PIXMA Printing Solutions can be downloaded from App Store and Google Play.



## **Printing with Windows RT**

When you use Windows RT, printing is easy because you simply connect this machine to the network.

For information about connecting to the network, see [here](#).

When the connection is complete, the Canon Inkjet Print Utility software, which allows you to specify detailed print settings, is downloaded automatically.

By using Canon Inkjet Print Utility, you can check the printer status and specify detailed print settings. (The available functions will differ depending on your usage environment and connection method.)



# Printing with Google Cloud Print

The machine is compatible with Google Cloud Print™ (Google Cloud Print is a service provided by Google Inc.).

By using Google Cloud Print, you can print from anywhere with applications or services supporting Google Cloud Print.

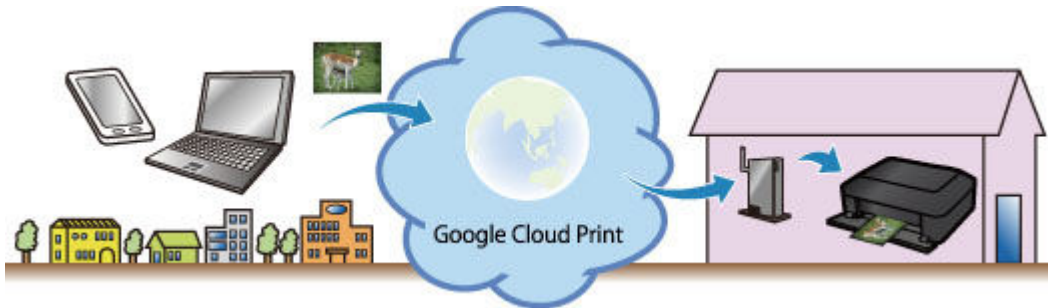

1. [Preparations for Printing with Google Cloud Print](#)
2. [Printing from Computer or Smartphone with Google Cloud Print](#)

## ►► Important

- LAN connection with the machine and Internet connection are required to register the machine and to print with Google Cloud Print. Internet connection fees apply.
- This function may not be available depending on the country or region you live in.

# Preparations for Printing with Google Cloud Print

To print with Google Cloud Print, you need to get Google account and register the machine with Google Cloud Print in advance.

➔ [Getting Google Account](#)

If you already have Google account, register the machine.

➔ [Registering the Machine with Google Cloud Print](#)

## Getting Google Account

First, get your Google account in order to register the machine with Google Cloud Print.

Access to Google Cloud Print with the web browser on the computer or the mobile device, then register the required information.

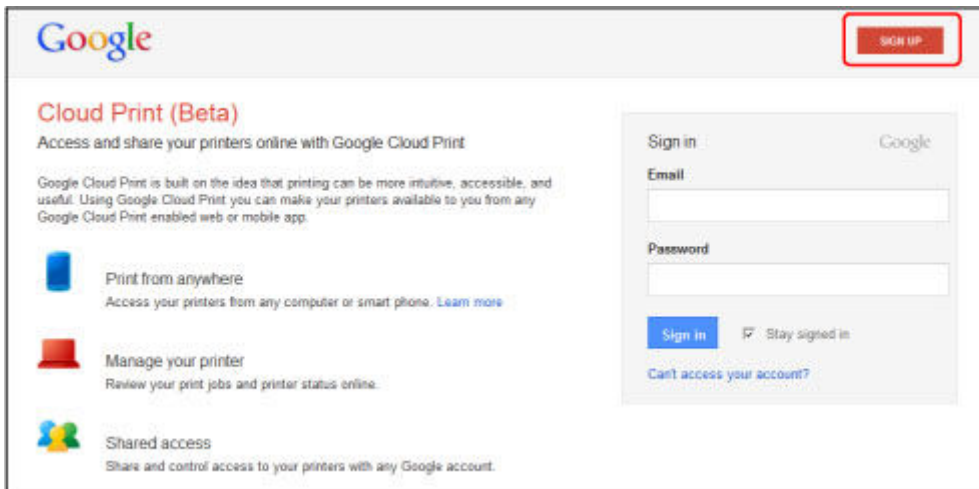

\* The screen above may change without prior notice.

## Registering the Machine with Google Cloud Print

Register the machine with Google Cloud Print.

The authentication procedure using the web browser on the computer or the mobile device is required in the process of registering. Because the authentication URL is printed from machine when the authentication process is performed, prepare A4 or Letter-sized plain paper.

### ➤➤➤ Important

- LAN connection with the machine and Internet connection are required to register the machine and to print with Google Cloud Print. Internet connection fees apply.
- If the machine's owner changes, [delete the machine from Google Cloud Print](#).

1. Make sure that the machine is turned on

### If your printer has a LCD monitor

2. From the Home screen, select **Setup** (or press the **Setup** button on the operation panel)

3. Select **Web service setup** -> **Connection setup** -> **Google Cloud Print setup (GoogleCloudPrint)** -> **Register with Google Cloud Print (Register w/ service)**

»» **Note**

- If you have already registered the machine with Google Cloud Print, the confirmation message to re-register the machine is displayed.

4. When the confirmation screen to register the machine is displayed, select **Yes**

5. Select a display language on the print setting screen of Google Cloud Print

The confirmation message to print the authentication URL is displayed.

6. Load A4 or Letter-sized plain paper, then select OK

The authentication URL is printed.

7. Ensure that the authentication URL is printed, select **Yes**

8. Perform the authentication process using the web browser on the computer or the mobile device

Access to the URL using the web browser on the computer or the mobile device and perform the authentication process following the on-screen instructions.

»» **Note**

- Perform the authentication process with your Google account which you have gotten in advance.

9. When the message that the registration is complete is displayed on the LCD of the machine, select OK

When authentication process is complete properly, the registration items are displayed. When authentication process is complete, [you can print the data with Google Cloud Print](#).

When authentication process is not complete properly and the error message is displayed, select OK. When the confirmation message to print the authentication URL is displayed, print the authentication URL, then perform the authentication process on the computer again.

## If your printer does not have a LCD monitor

2. [Remote UI startup](#)

3. Select **Google Cloud Print setup** -> **Register with Google Cloud Print**

»» **Note**

- If you have already registered the machine with Google Cloud Print, the confirmation message to re-register the machine is displayed.

4. When the confirmation screen to register the machine is displayed, select **Yes**
5. In the print setup for Google Cloud Print, select the display language, and then select **Authentication**
6. When the registration completion message appears, select OK

## Deleting the Machine from Google Cloud Print

If the machine's owner changes or if you want to re-register the machine, delete the machine from Google Cloud Print by following the steps below.

1. Make sure that the machine is turned on

### If your printer has a LCD monitor

2. From the Home screen, select **Setup** (or press the **Setup** button on the operation panel)
3. Select **Web service setup** -> **Connection setup** -> **Google Cloud Print setup (GoogleCloudPrint)** -> **Delete from Google Cloud Print (Delete from service)**
4. When the confirmation screen to delete the machine is displayed, select **Yes**

### If your printer does not have a LCD monitor

2. [Remote UI startup](#)
3. Select **Google Cloud Print setup** -> **Delete from Google Cloud Print**
4. When the confirmation screen to delete the machine is displayed, select **Yes**

# Printing from Computer or Smartphone with Google Cloud Print

When you send print data with Google Cloud Print, the machine receives the print data and prints it automatically if the machine is turned on.

When printing from a computer, smartphone, or other external device with Google Cloud Print, load paper into the machine in advance.

## Sending the Print Data with Google Cloud Print

1. Make sure that the machine is turned on

### ►►► Note

- If you want to send the print data from an outside location, turn on the machine in advance.

2. Print from the computer or smartphone

The figure below is an example of when printing from the web browser corresponding with Google Cloud Print. The screen differs depending on the applications or services supporting Google Cloud Print.

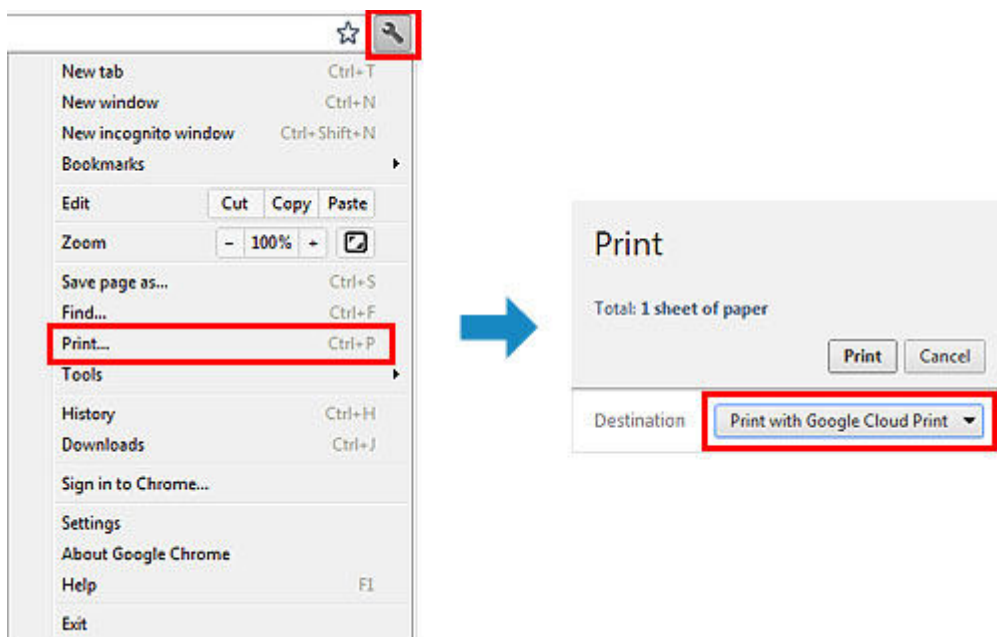

When the preparation for printing with Google Cloud Print is complete and when the machine is turned on, the machine receives the print data and prints it automatically.

### ►►► Note

- Depending on the communication status, it may take a while to print the print data or the machine may not receive the print data.
- While printing with Google Cloud Print, the printing may be canceled depending on the machine's status, such as when the machine is being operated or an error has occurred. To resume printing, check the machine's status, then print with Google Cloud Print again.
- For print settings:
  - If you select the media type other than plain paper or if you select the paper size other than A4/ Letter/B5/A5-size, the print data is printed in single-sided even when you select the duplex print setting. (\* The paper size differs depending on the model of your printer. For information about

the supported paper sizes, go to the *Online Manual* home page, and refer to the "Cannot Print Properly with Automatic Duplex Printing" for your model.)

- If you select plain paper as media type or if you select B5/A5-size as paper size, the print data is printed with border even when you select the borderless print setting.
- The print results may differ from the print image depending on the print data.
- Depending on the device sending the print data, you may not select the print settings when sending the print data with Google Cloud Print.

## When you want to print from Google Cloud Print immediately

When the machine cannot receive the print data, or you want to start printing immediately, you can check whether there is a print job on the Google Cloud Print and start printing manually.

Follow the steps below.

### ▶▶▶ Important

- Depending on your printer model, this function may not be available.

1. Make sure that the machine is turned on
2. From the Home screen, select **Setup** (or press the **Setup** button on the operation panel)
3. Select **Web service inquiry**

### ▶▶▶ Note

- If you have not registered the machine with Google Cloud Print, **Web service inquiry** is not displayed.

[Register the machine with Google Cloud Print.](#)

## If your LCD monitor is a color model

4. Select **Print from Google Cloud Print**

The confirmation screen to check is displayed.

5. Select **Yes**

If there is the print data, the machine receives the print data and prints it.

## If your LCD monitor is a monochrome model

4. Select **GoogleCloudPrint**

5. Press the **OK** button

Connect to the server. If print data is available, print that data.

## Using Remote UI

This service allows you to check printer information and execute utility functions from your computer or smartphone.

You can also use the convenient web services presented by Canon.

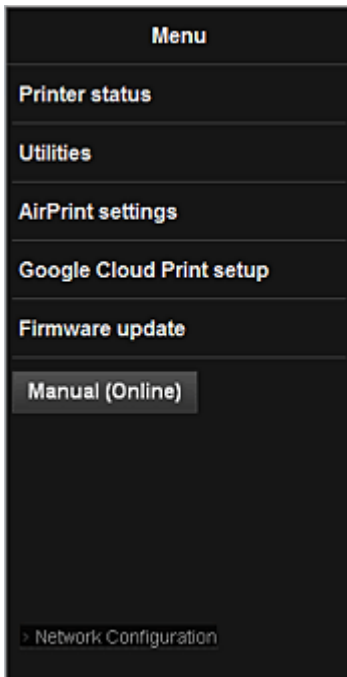

### Checking the printer IP address

To use this service, first check the IP address of this machine from the operation panel of the machine.

#### ►► Important

- Before you check the IP address of this machine or use the **Remote UI**, make sure that the machine is connected to the LAN and the LAN environment is connected to the Internet. Note that the customer is responsible for paying all Internet connection fees.

1. Check that the machine has been turned on

#### If your printer has a LCD monitor

2. From the home window, select  **Setup** ->  **Device settings** -> **LAN settings** -> **Confirm LAN settings** -> **WLAN setting list** or **LAN setting list**. Then from the displayed window, check the IP address.

#### ►► Note

- To print the IP address, load one sheet of A4 size or Letter size plain paper. Then from the

home window, select  **Setup** ->  **Device settings** -> **LAN settings** -> **Confirm LAN settings** -> **Print LAN details**, in sequence.

## If your printer does not have a LCD monitor

2. Load one sheet of A4 size or Letter size plain paper
3. Hold down the **Stop** button until the **Alarm** lamp flashes 6 times
4. Release the button

Printing of the network setup information starts.

## Remote UI startup

In the Web browser, directly enter the IPv4 address that you checked from the LCD monitor of the machine. The **Remote UI** starts.

1. From your computer, smartphone, or tablet device, open the Web browser, and enter the following URL:

http:// <Printer IP address>

For "<Printer IP address>" enter the IP address that you checked in "Checking the printer IP address."

2. **Remote UI** startup

The **Remote UI** starts and the top window is displayed.

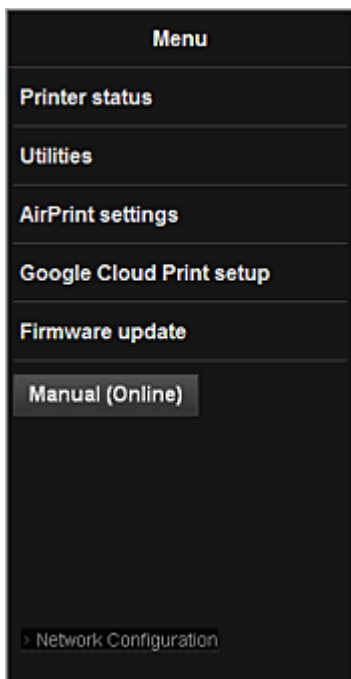

### Printer status

This function displays printer information such as the remaining ink amount, the status, and detailed error information.

You can also connect to the ink purchase site or support page, and use Web Services.

### Utilities

This function allows you to set and execute the machine utility functions such as cleaning.



**AirPrint settings**

This function allows you to specify the Apple AirPrint settings, such as position information.

**Google Cloud Print setup**

This function allows you to register this machine to Google Cloud Print or delete the machine.

**Firmware update**

This function allows you to update the firmware and check version information.

**Manual (Online)**

This function displays the *Online Manual*.

**Network Configuration**

This function displays the network settings.

## Printing from AirPrint Compliant Device

This document explains how to use AirPrint to print wirelessly from your iPad, iPhone and iPod touch to a Canon printer.

AirPrint enables you to print photos, email, Web pages and documents from your Apple device directly to your printer without installing a driver.



### Checking Your Environment

First, check your environment.

- **AirPrint Operation Environment**

To use AirPrint, you will need one of the following Apple devices running the latest version of iOS:

- iPad (all models)
- iPhone (3GS or later)
- iPod touch (3rd generation or later)

- **Network Environment**

The Apple device (iPad, iPhone, or iPod touch) and this machine must be connected to the same Wi-Fi network.

### Printing with AirPrint

1. Check that this machine is turned on and is connected to the LAN.
2. From the app of your Apple device, tap the operation icon to display the menu options.

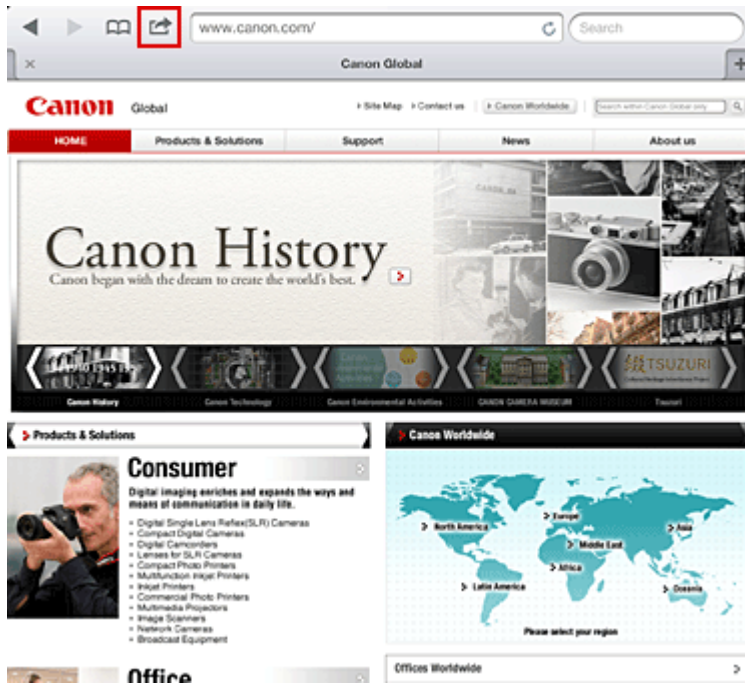

3. From the menu options, tap **Print**.



4. From **Printer Options**, select the model that you are using.

### Important

- Because some app does not support AirPrint, **Printer Options** may not be displayed. If an app does not let you use printer options, you cannot print from that app.

### Note

- The printer options differ depending on the app and model you are using. Normally, when you tap **Print** and select a model name, the displayed printer options will include up to the following four options:
  - Printer: Select a model that can be used in your wireless LAN.

- Copies: Select the number of print copies.
- Duplex Printing: If the model supports duplex printing, you can select **On** or **Off**.
- Range: The page range can be used only with specific app and file types (such as PDF files).

5. For **1 Copy**, click **+** or **-** to set the number of required copies.
6. For **Duplex Printing**, click **On** to enable duplex printing or click **Off** to disable the function.
7. When printing a file type that has multiple pages, such as a PDF file, click **Range** and then click **All Pages** or select the range of pages to be printed.
8. Tap the **Print**.

When you execute printing, the printer prints according to the specified settings.

## Paper Size

With AirPrint, the paper size is selected automatically according to the app being used on the Apple device and the region in which AirPrint is used.

When Apple's photo app is used, the default paper size is L size in Japan, and 4"x6" or KG in other countries and regions.

When documents are printed from Apple's Safari app, the default paper size is letter size in the U.S. region, and A4 in Japan and Europe.

### ▶▶ Important

- Your app may support different paper sizes.

## Checking the Print Status

During printing, a **Print** icon is displayed in the list of recently used app, and you can use it to check the print progress.

To display the list of latest used app, press the **Home** button on the Apple device twice. The **Print** icon is displayed at the bottom of the **Home** screen.



## Deleting a Print Job

To delete a print job with AirPrint, use one of the following two methods:

- From the machine: If your printer has a LCD monitor, use the operation panel to cancel the print job. If your printer does not have a LCD monitor, press the **Stop** button on the machine to cancel the print job.
- From an Apple device: Press the **Home** button on the Apple device twice. Tap the **Print** icon and display the print job list. Tap the print job to be canceled, and then tap **Cancel Print**.

## AirPrint Troubleshooting

If the document does not print, check the following:

1. Check that the machine power is on. If the machine power is on, turn it off and then back on again, and check whether the issue is resolved.
2. Check that the machine is connected by LAN to the same network subnet as the device on which iOS is installed.
3. Check that the machine has enough paper and ink.
4. If your printer has a LCD monitor, check that no error message is displayed on the LCD monitor.

If the problem persists, use the printer driver on your computer to execute printing and check whether the document can be printed normally on the machine.

If the document cannot be printed, refer to the *Online Manual* for your model.

**»» Note**

- After you turn on the machine, it may take few minutes before the machine can communicate through a wireless LAN connection. Confirm that the machine is connected to the wireless LAN, and then try printing.
- If Bonjour on the machine is disabled, AirPrint cannot be used. Check the LAN settings on the machine, and enable Bonjour.

**»» Note**

- The windows used in the explanations may differ from those displayed by your Apple product or app.

# Overview of the Printer

## ▶ **Safety Guide**

- Safety Precautions
- Regulatory and Safety Information

## ▶ **Main Components and Basic Operations**

- Main Components
- About the Power Supply of the Printer

## ▶ **Loading Paper**

- Loading Paper
- Placing a Printable Disc

## ▶ **Replacing an Ink Tank**

- Replacing an Ink Tank
- Checking the Ink Status

## ▶ **Maintenance**

- When Printing Becomes Faint or Colors Are Incorrect
- Performing Maintenance from a Computer
- Cleaning the Printer

## ▶ **Changing the Printer Settings**

- Changing Printer Settings from Your Computer
- Initializing the Printer Settings

## ▶ **Information about Network Connection**

- Useful Information about Network Connection

## ▶ **About Network Communication**

- Changing and Confirming Network Settings
- Screens for Network Connection of IJ Network Tool
- Other Screens of IJ Network Tool
- Appendix for Network Communication

## ▶ **Tips for Ensuring Optimal Printing Quality**

- Useful Information about Ink
- Key Points to Successful Printing
- Be Sure to Make Paper Settings after Loading Paper
- Canceling a Print Job
- Printer Handling Precautions
- Key to Enjoying Consistent Printing Quality
- Precautions for Safe Transport of the Printer

## ▶ **Legal Limitations on Use of Your Product and Use of Images**

## ▶ **Specifications**

## **Safety Guide**

- ▶ **Safety Precautions**
- ▶ **Regulatory and Safety Information**



# Safety Precautions

## Choosing a location

- Do not install the machine in a location that is unstable or subject to excessive vibration.
- Do not install the machine in locations that are very humid or dusty, in direct sunlight, outdoors, or close to a heating source.  
To avoid the risk of fire or electric shocks, use the machine under the operating environment specified in the On-screen Manual.
- Do not place the machine on a thick rug or carpet.
- Do not place the machine with its back attached to the wall.

## Power supply

- Ensure that the area around the power outlet is kept clear at all times so you can easily unplug the power cord if necessary.
- Never remove the plug by pulling on the cord.  
Pulling the cord may damage the power cord, leading to possible fire or electrical shock.
- Do not use an extension lead/cord.

## Working around the machine

- Never put your hands or fingers in the machine while it is printing.
- When moving the machine, carry the machine at both ends. In case the machine weighs more than 14 kg, it is recommended to have two people lifting the machine. Accidental dropping of the machine causes injury. For the machine's weight, refer to the On-screen Manual.
- Do not place any object on the machine. Especially do not place metal objects (paper clips, staples, etc.) or containers of flammable solvents (alcohol, thinners, etc.) on top of the machine.
- Do not transport or use the machine on a slant, vertically or upside-down, as the ink may leak and damage the machine.

## Working around the machine (For the multifunction printer)

- When loading a thick book on the Platen Glass, do not press hard on the Document Cover. The Platen Glass may break and cause injury.

## Print Heads/ink tanks and FINE Cartridges

- Keep ink tanks out of the reach of children. In case ink\* is accidentally licked or swallowed, rinse out mouth or give one or two glasses of water to drink. If irritation or discomfort occurs, obtain medical advice immediately.  
\* Clear Ink contains nitrate salts (For models containing Clear Ink).
- In case ink gets in contact with eyes, rinse with water immediately. In case ink gets in contact with skin, wash with soap and water immediately. If irritation to eyes or skin persists, obtain medical advice immediately.
- Never touch the electrical contacts on a Print Head or FINE Cartridges after printing.  
The metal parts may be very hot and could cause burns.
- Do not throw ink tanks and FINE Cartridges into fire.
- Do not attempt to disassemble or modify the Print Head, ink tanks, and FINE Cartridges.

# Regulatory and Safety Information

## About the disposal of the battery (For models containing lithium battery)

Dispose of used batteries according to the local regulations.

## Users in the U.S.A.

FCC Notice (U.S.A. Only)

For 120V, 60Hz model

Model Number: K10390/K10391 (Contains FCC ID: AZDK30357)

This device complies with Part 15 of the FCC Rules. Operation is subject to the following two conditions:

(1) This device may not cause harmful interference, and (2) this device must accept any interference received, including interference that may cause undesired operation.

Note: This equipment has been tested and found to comply with the limits for a Class B digital device, pursuant to Part 15 of the FCC Rules. These limits are designed to provide reasonable protection against harmful interference in a residential installation. This equipment generates, uses and can radiate radio frequency energy and, if not installed and used in accordance with the instructions, may cause harmful interference to radio communications.

However, there is no guarantee that interference will not occur in a particular installation. If this equipment does cause harmful interference to radio or television reception, which can be determined by turning the equipment off and on, the user is encouraged to try to correct the interference by one or more of the following measures:

- Reorient or relocate the receiving antenna.
- Increase the separation between the equipment and receiver.
- Connect the equipment into an outlet on a circuit different from that to which the receiver is connected.
- Consult the dealer or an experienced radio/TV technician for help.

Use of a shielded cable is required to comply with Class B limits in Subpart B of Part 15 of the FCC Rules.

Do not make any changes or modifications to the equipment unless otherwise specified in the manual. If such changes or modifications should be made, you could be required to stop operation of the equipment.

FCC ID:AZDK30357

Changes or modifications not expressly approved by the party responsible for compliance could void the user's authority to operate equipment.

This transmitter must not be co-located or operating in conjunction with any other antenna or transmitter.

The equipment complies with FCC radiation exposure limits for uncontrolled equipment. This equipment should be installed and operated with minimum distance at least 20cm between the radiator and persons body (excluding extremities: hands, wrists, feet and ankles) and must not be colocated or operated with any other antenna or transmitter.

Canon U.S.A., Inc.

One Canon Park

Melville, New York 11747

1-800-652-2666

## Users in Canada

This device complies with Industry Canada license-exempt RSS standard(s). Operation is subject to the following two conditions:

(1) this device may not cause interference, and (2) this device must accept any interference, including interference that may cause undesired operation of the device.

This equipment complies with IC radiation exposure limits set forth for an uncontrolled environment and meets RSS-102 of the IC radio frequency (RF) Exposure rules. This equipment should be installed and operated keeping the radiator at least 20cm or more away from person's body (excluding extremities: hands, wrists, feet and ankles).

## Pour les usagers résidant au Canada

Le présent appareil est conforme aux CNR d'Industrie Canada applicables aux appareils radio exempts de licence. L'exploitation est autorisée aux deux conditions suivantes :

(1) l'appareil ne doit pas produire de brouillage, et (2) l'utilisateur de l'appareil doit accepter tout brouillage radioélectrique subi, même si le brouillage est susceptible d'en compromettre le fonctionnement.

Cet équipement est conforme aux limites d'exposition aux rayonnements énoncées pour un environnement non contrôlé et respecte les règles d'exposition aux fréquences radioélectriques (RF) CNR-102 de l'IC. Cet équipement doit être installé et utilisé en gardant une distance de 20 cm ou plus entre le dispositif rayonnant et le corps (à l'exception des extrémités : mains, poignets, pieds et chevilles).

## Users in Jordan

This printer contains WLAN Module approved by TRC/LPD/2013/130

Name of WLAN Module : K30357

## European Union (and EEA) only.



This symbol indicates that this product is not to be disposed of with your household waste, according to the WEEE Directive (2002/96/EC) and your national law. This product should be handed over to a designated collection point, e.g., on an authorized one-for-one basis when you buy a new similar product or to an authorized collection site for recycling waste electrical and electronic equipment (EEE). Improper handling of this type of waste could have a possible negative impact on the environment and human health due to potentially hazardous substances that are generally associated with EEE. At the same time, your cooperation in the correct disposal of this product will contribute to the effective usage of natural resources. For more information about where you can drop off your waste equipment for recycling, please contact your local city office, waste authority, approved WEEE scheme or your household waste disposal service. For more information regarding return and recycling of WEEE products, please visit [www.canon-europe.com/environment](http://www.canon-europe.com/environment).

(EEA: Norway, Iceland and Liechtenstein)

## India only.



This product is not to be disposed of with your household waste, according to the e-waste (Management and Handling) Rules, 2011.

This product should be handed over to a designated collection point, e.g., to an authorized collection site for recycling waste electrical and electronic equipment (EEE). Improper handling of this type of waste could have a possible negative impact on the environment and human health due to potentially hazardous substances that are generally associated with EEE. At the same time, your cooperation in the correct disposal of this product will contribute to the effective usage of natural resources. For more information regarding return and recycling of WEEE products, please visit <http://www.canon.co.in/environment/>.

Also, this product complies with the "India E-waste Rule 2011" and prohibits use of lead, mercury, hexavalent chromium, polybrominated biphenyls or polybrominated diphenyl ethers in concentrations exceeding 0.1 % by weight and 0.01 % by weight for Cadmium, except for the exemptions set in Schedule II of the Rule.

## Environmental Information

Reducing your environmental impact while saving money

### Power Consumption and Activation Time

The amount of electricity a device consumes depends on the way the device is used. This product is designed and set in a way to allow you to reduce your electricity costs. After the last print it switches to Ready Mode. In this mode it can print again immediately if required. If the product is not used for a time, the device switches to its Power Save Mode. The devices consume less power (Watt) in these modes. If you wish to set a longer Activation Time or would like to completely deactivate the Power Save Mode, please consider that this device may then only switch to a lower energy level after a longer period of time or not at all.

Canon does not recommend extending the Activation Times from the optimum ones set as default.

### Energy Star®

The Energy Star® programme is a voluntary scheme to promote the development and purchase of energy efficient models, which help to minimise environmental impact.

Products which meet the stringent requirements of the Energy Star® programme for both environmental benefits and the amount of energy consumption will carry the Energy Star® logo accordingly.

### Paper types

This product can be used to print on both recycled and virgin paper (certified to an environmental stewardship scheme), which complies with EN12281 or a similar quality standard. In addition it can support printing on media down to a weight of 64g/m<sup>2</sup>, lighter paper means less resources used and a lower environmental footprint for your printing needs.



## **Main Components and Basic Operations**

- **Main Components**
- **About the Power Supply of the Printer**

## **Main Components**

- ▶ **Front View**
- ▶ **Rear View**
- ▶ **Inside View**

## Front View

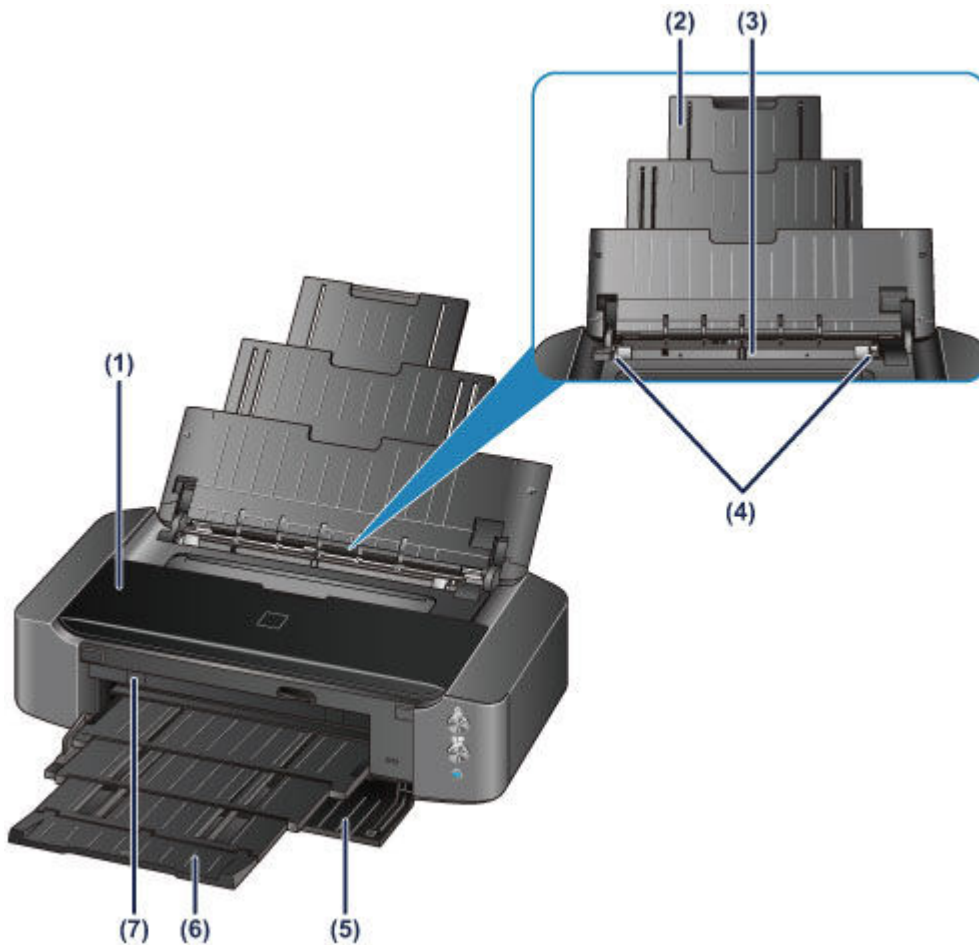

### (1) top cover

Open to replace an ink tank or remove jammed paper inside the printer.

### (2) paper support

Extend to load paper in the rear tray.

### (3) rear tray

Load paper here. Two or more sheets of the same size and type of paper can be loaded at the same time, and fed automatically one sheet at a time.

➡ [Loading Plain Paper / Photo Paper](#)

➡ [Loading Envelopes](#)

### (4) paper guides

Align with both sides of the paper stack.

### (5) front cover

Open to pull out the paper output tray before printing.

### (6) paper output tray

Printed paper is ejected. Open it before printing.

### (7) disc tray guide

Attach the disc tray here. Use when printing onto a printable disc. Keep closed for normal operation.



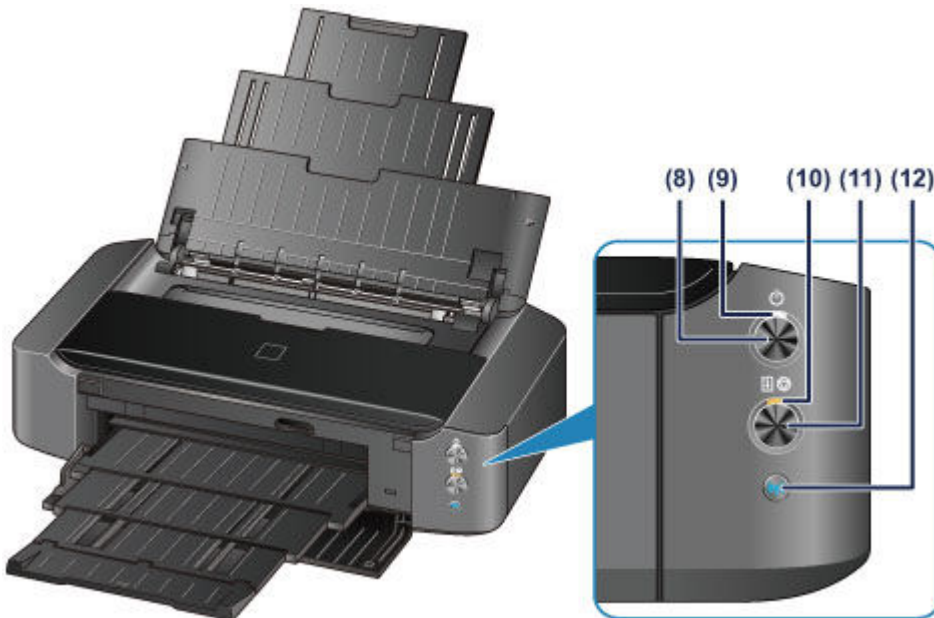

\* All lamps are shown lit in the above figure for explanatory purposes.

**(8) ON button**

Press to turn the power on or off.

➔ [Turning the Printer On and Off](#)

**(9) POWER lamp**

Lights white after flashing when the power is turned on.

**➤➤➤ Note**

- You can check the status of the printer by the **POWER** and **Alarm** lamps.
  - **POWER** lamp is off: The power is off.
  - **POWER** lamp lights white: The printer is ready to print.
  - **POWER** lamp flashes white: The printer is getting ready to print, or printing is in progress.
  - **Alarm** lamp flashes orange: An error has occurred and the printer is not ready to print.
  - **POWER** lamp flashes white and **Alarm** lamp flashes orange alternately: An error that requires contacting the service center may have occurred.

➔ [If an Error Occurs](#)

**(10) Alarm lamp**

Lights or flashes orange when an error occurs.

**(11) RESUME/CANCEL button**

Press to cancel a print job in progress. You can press this button to release from printer error status and resume printing, after the printer problem is resolved.

**(12) Wi-Fi button/Wi-Fi lamp**

Hold down to automatically set up the wireless LAN connection.

Lights or flashes blue to indicate the wireless LAN status.

**Lights:**

Wireless LAN connection is enabled.

**Flashes:**

Printing or scanning over wireless LAN. Also flashes while configuring the wireless LAN connection.

## Rear View

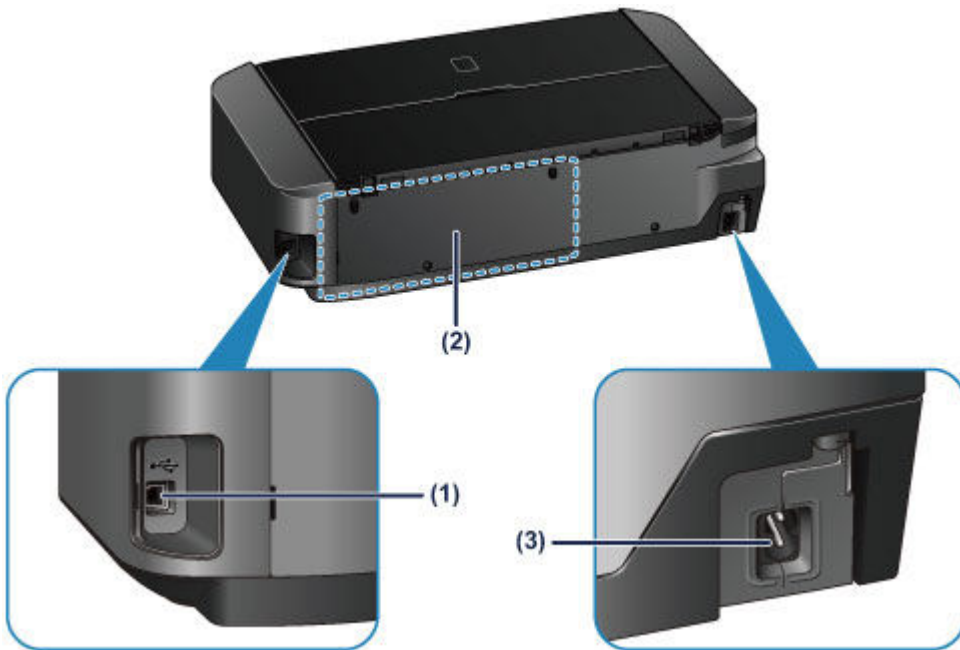

### (1) USB port

Plug in the USB cable to connect the printer with a computer.

### (2) disc tray storage compartment

The disc tray supplied with the printer can be stored here.

➔ [Storing the disc tray](#)

### (3) power cord connector

Plug in the supplied power cord.

## ▶▶▶ Important

- Do not touch the metal casing.
- Do not plug in or unplug the USB cable while printing.

## Inside View

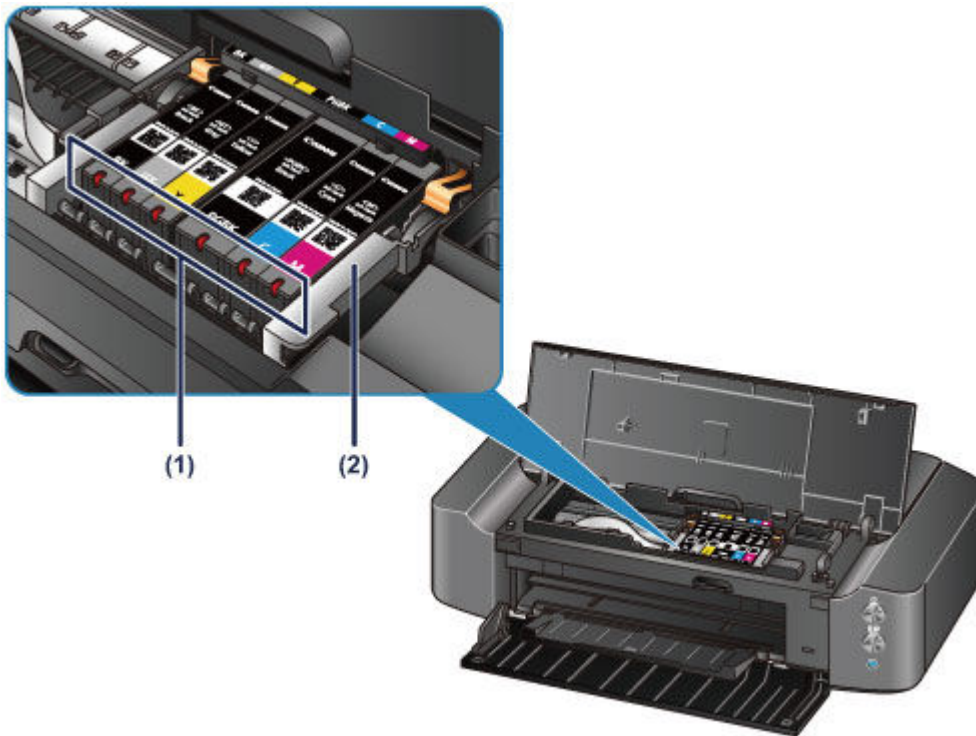

### (1) ink lamps

Lights or flashes red to indicate the ink tank status.

➔ [Checking the Ink Status with the Ink Lamps](#)

### (2) print head holder

The print head is pre-installed.

### »» Note

- For details on replacing an ink tank, see [Replacing an Ink Tank](#).

## **About the Power Supply of the Printer**

- **Confirming that the Power Is On**
- **Turning the Printer On and Off**
- **Notice for the Power Plug/Power Cord**
- **Notice for Unplugging the Power Cord**

## Confirming that the Power Is On

The **POWER** lamp is lit white when the printer is turned on.



### ▶▶ Note

- It may take a while for the printer to start printing immediately after you turn on the printer.

# Turning the Printer On and Off

## Turning on the printer

1. Press the **ON** button to turn on the printer.

The **POWER** lamp flashes and then remains lit white.

➔ [Confirming that the Power Is On](#)



### ➤➤➤ Note

- It may take a while for the printer to start printing immediately after you turn on the printer.
- If the **Alarm** lamp flashes orange, see [If an Error Occurs](#).
- You can set the printer to automatically turn on when a print operation is performed from a computer connected by USB cable or wireless network. This feature is set to off by default.

➔ [Managing the Printer Power](#)

## Turning off the printer

1. Press the **ON** button to turn off the printer.

When the **POWER** lamp stops flashing, the printer is turned off.



### ➤➤➤ Important

- When you [unplug the power cord](#) after turning off the printer, be sure to confirm that the **POWER** lamp is off.

### ➤➤➤ Note

- You can set the printer to automatically turn off when no print jobs are sent to the printer for a certain interval. This is the default setting.



## Notice for the Power Plug/Power Cord

Unplug the power cord once a month to confirm that the power plug/power cord does not have anything unusual described below.

- The power plug/power cord is hot.
- The power plug/power cord is rusty.
- The power plug/power cord is bent.
- The power plug/power cord is worn.
- The power plug/power cord is split.

### **Caution**

- If you find anything unusual with the power plug/power cord described above, [unplug the power cord](#) and call for service. Using the printer with one of the unusual conditions above may cause a fire or an electric shock.



## Notice for Unplugging the Power Cord

To unplug the power cord, follow the procedure below.

### ▶▶▶ Important

- When you unplug the power cord, press the **ON** button, then confirm that the **POWER** lamp is off. Unplugging the power cord while the **POWER** lamp is lit or flashing white may cause drying or clogging of the print head and print quality may be reduced.

1. Press the **ON** button to turn the printer off.



2. Confirm that the **POWER** lamp is off.



3. Unplug the power cord.

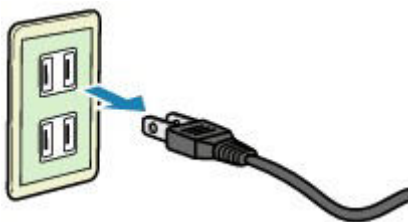

The specification of the power cord differs depending on the country or region of use.

## **Loading Paper**

- ▶ **Loading Paper**
- ▶ **Placing a Printable Disc**

## **Loading Paper**

- ▶ **Loading Plain Paper / Photo Paper**
- ▶ **Loading Envelopes**
- ▶ **Media Types You Can Use**
- ▶ **Media Types You Cannot Use**
- ▶ **Before Printing on Art Paper**
- ▶ **Printing Area**

## Loading Plain Paper / Photo Paper

You can load plain paper or photo paper.

### ▶▶▶ Important

- If you cut plain paper into small size such as 4" x 6" (10 x 15 cm) or 5" x 7" (13 x 18 cm) to perform trial print, it can cause paper jams.

### ▶▶▶ Note

- We recommend Canon genuine photo paper for printing photos.  
For details on the Canon genuine paper, see [Media Types You Can Use](#).
- You can use general copy paper.  
For the page size and paper weight you can use for this printer, see [Media Types You Can Use](#).

#### 1. Prepare paper.

Align the edges of paper. If paper is curled, flatten it.

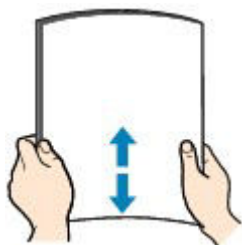

### ▶▶▶ Note

- Align the edges of paper neatly before loading. Loading paper without aligning the edges may cause paper jams.
- If paper is curled, hold the curled corners and gently bend them in the opposite direction until the paper becomes completely flat.  
For details on how to flatten curled paper, see "Load the paper after correcting its curl." in [Paper Is Smudged/Printed Surface Is Scratched](#).
- When using Photo Paper Plus Semi-gloss SG-201, even if the sheet is curled, load one sheet at a time as it is. If you roll up this paper to flatten, this may cause cracks on the surface of the paper and reduce the print quality.

#### 2. Load paper.

1. Open the paper support, and pull it out.
2. Open the front cover gently.

### ▶▶▶ Important

- If the disc tray guide (A) is open, close it.

3. Pull out the paper output tray.

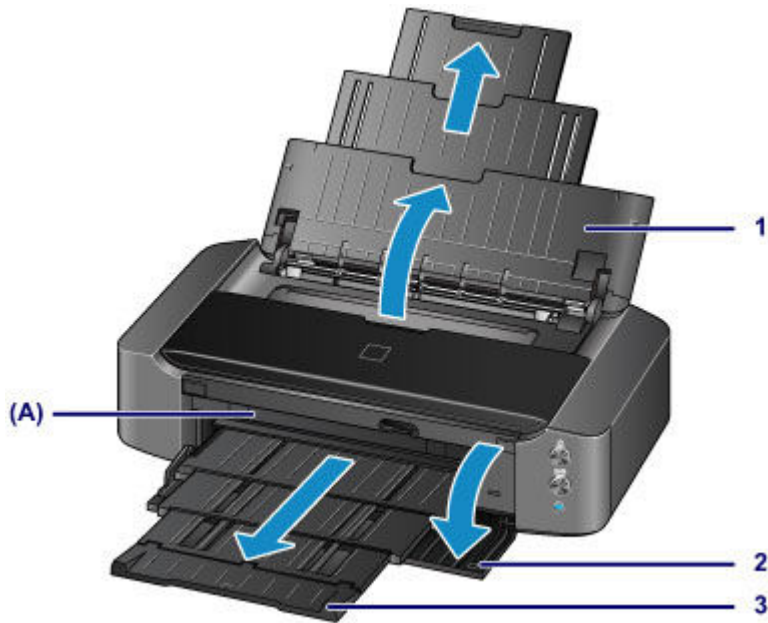

4. Slide the paper guides (B) to open them, and load the paper in the center of the rear tray WITH THE PRINT SIDE FACING YOU.
5. Slide the paper guides (B) to align them with both sides of the paper stack.  
Do not slide the paper guides too hard. The paper may not be fed properly.

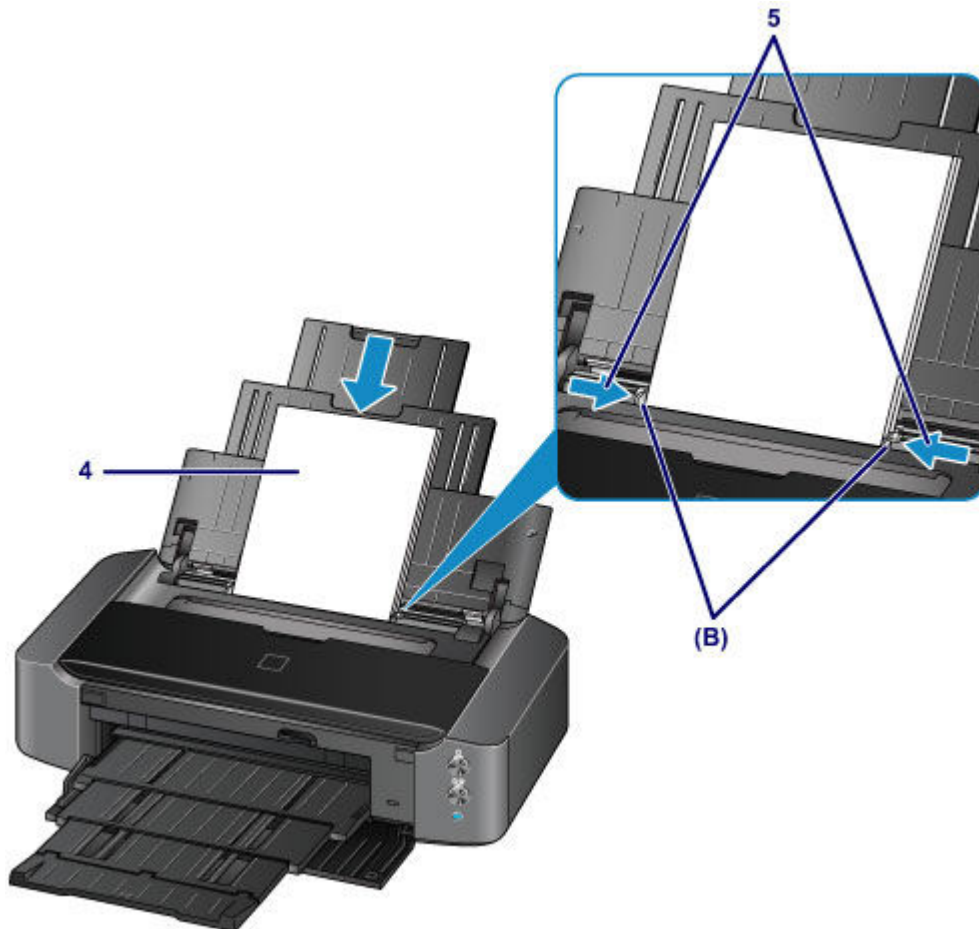

**»» Important**

- Always load paper in the portrait orientation (C). Loading paper in the landscape orientation (D) can cause paper jams.



(C)

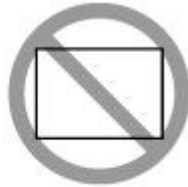

(D)

▶▶▶ **Note**

- Do not load sheets of paper higher than the load limit mark (E).

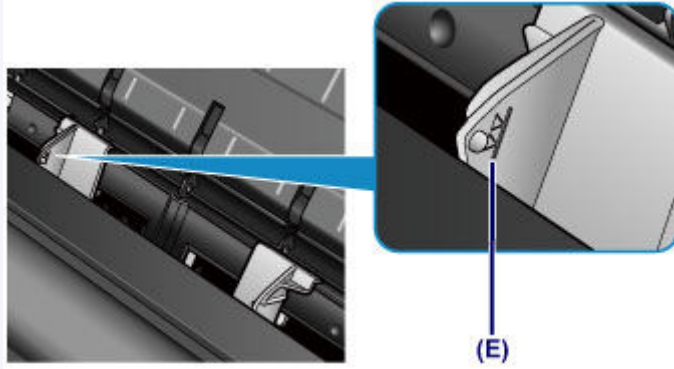

▶▶▶ **Note**

- After loading paper, select the size and type of the loaded paper on the print settings screen of the printer driver.

# Loading Envelopes

You can load Envelope DL and Envelope Com 10.

The address is automatically rotated and printed according to the envelope's direction by specifying with the printer driver properly.

## ▶▶▶ Important

- Printing of envelopes from a digital camera is not supported.
- Do not use the following envelopes. They could jam in the printer or cause the printer to malfunction.
  - Envelopes with an embossed or treated surface
  - Envelopes with a double flap
  - Envelopes whose gummed flaps are already moistened and adhesive

### 1. Prepare envelopes.

- Press down on all four corners and edges of the envelopes to flatten them.

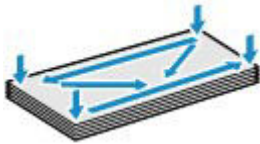

- If the envelopes are curled, hold the opposite corners and gently twist them in the opposite direction.



- If the corner of the envelope flap is folded, flatten it.
- Use a pen to press the leading edge in the inserting direction flat and sharpen the crease.

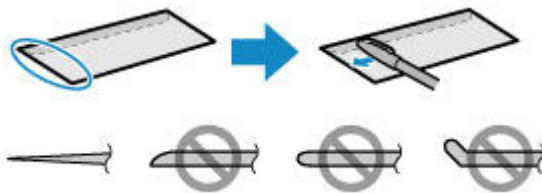

The figures above show a side view of the leading edge of the envelope.

## ▶▶▶ Important

- The envelopes may jam in the printer if they are not flat or the edges are not aligned. Make sure that no curl or puff exceeds 0.1 inch (3 mm).

### 2. Load envelopes.

1. Open the paper support, and pull it out.
2. Open the front cover gently.

## ▶▶▶ Important

- If the disc tray guide (A) is open, close it.

3. Pull out the paper output tray.

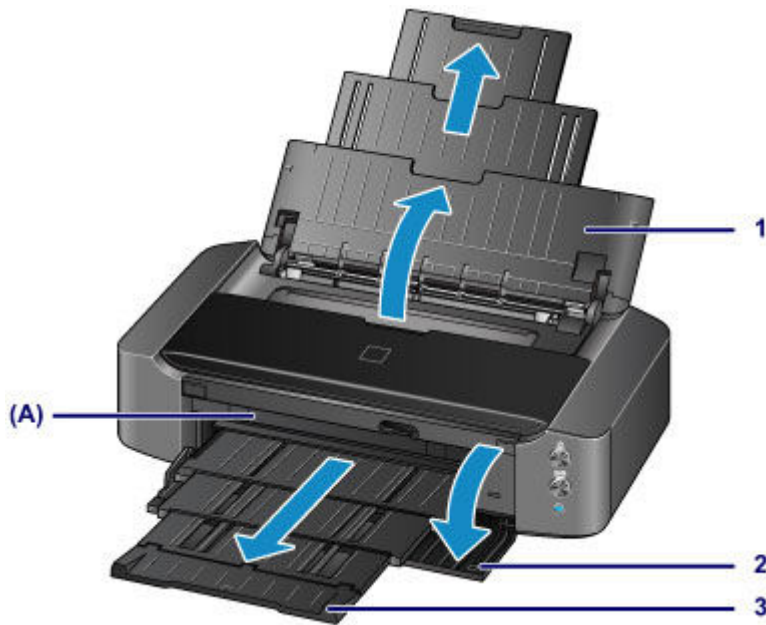

4. Slide the paper guides (B) to open them, and load the paper in the center of the rear tray WITH THE PRINT SIDE FACING YOU.

The folded flap of the envelope will be faced up on the left side.

Up to 10 envelopes can be loaded at once.

5. Slide the paper guides (B) to align them with both sides of the envelopes.

Do not slide the paper guides too hard against the envelopes. The envelopes may not be fed properly.

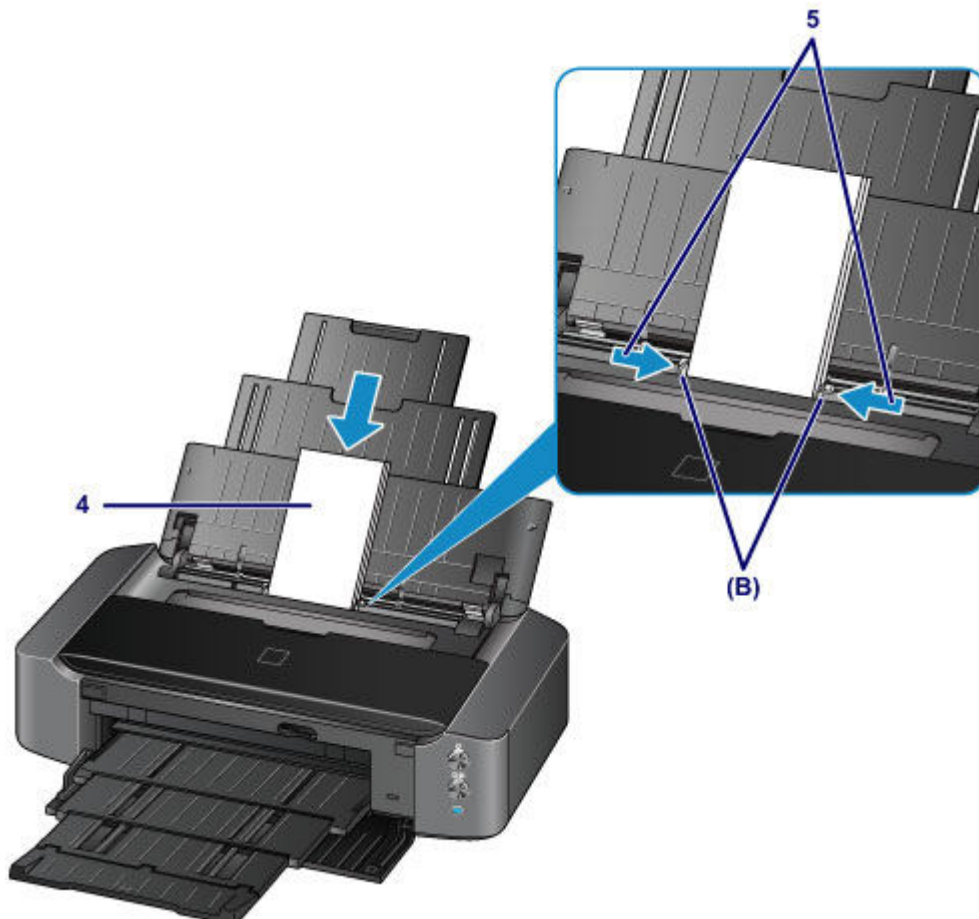



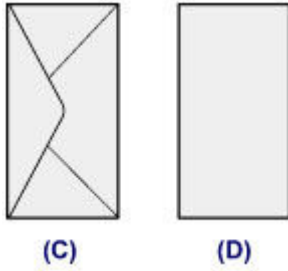

(C) Rear side  
(D) Address side

**▶▶▶ Note**

- Do not load envelopes higher than the load limit mark (E).

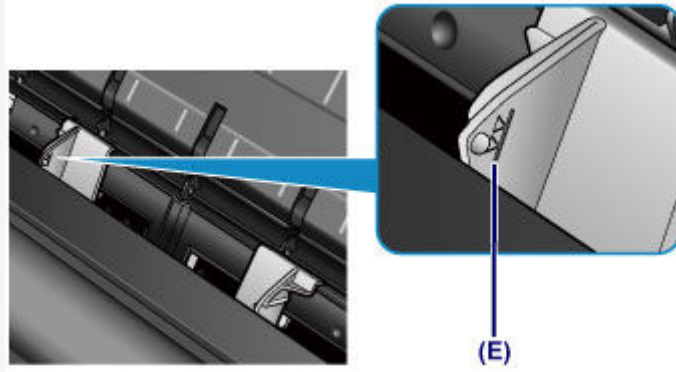

**▶▶▶ Note**

- After loading envelopes, select the size and type of the loaded envelopes on the print settings screen of the printer driver.

# Media Types You Can Use

Choose paper suitable for printing, for the best print results. Canon provides you various types of paper to enhance the fun of printing, such as stickers as well as papers for photo or document. We recommend the use of Canon genuine paper for printing your important photos.

## Media Types

### Commercially available papers

- Plain Paper (including recycled paper)\*[1](#)
- Envelopes\*[2](#)

### Canon genuine papers

The Model Number of Canon genuine paper is shown in brackets. Refer to the instruction manual supplied with the paper for detailed information on the printable side and notes on handling paper. For information on the page sizes available for each Canon genuine paper, access our website.

#### ▶▶▶ Note

- You may not be able to purchase some Canon genuine papers depending on the country or region of purchase. Paper is not sold in the US by Model Number. Purchase paper by name.

#### Paper for printing photos:

- Photo Paper Pro Platinum <PT-101>
- Glossy Photo Paper "Everyday Use" <GP-501/GP-601>
- Photo Paper Glossy <GP-601>
- Photo Paper Plus Glossy II <PP-201>
- Photo Paper Pro Luster <LU-101>
- Photo Paper Plus Semi-gloss <SG-201>
- Matte Photo Paper <MP-101>

#### Paper for printing business documents:

- High Resolution Paper <HR-101N>\*[2](#)

#### Paper for creating your own prints:

- T-Shirt Transfers <TR-301>\*[2](#)
- Photo Stickers <PS-101>

\*1 100% recycled paper can be used.

\*2 Printing to this paper from a digital camera is not supported.

- ➡ [Paper Load Limit](#)
- ➡ [Setting the Media Type with the Printer Driver](#)

#### ▶▶▶ Note

- You can print onto a printable disc using the disc tray supplied with the printer.
  - ➡ [Placing a Printable Disc](#)
- When printing photos saved on a PictBridge compliant device, you must specify the page size and media type.

➡ [Printing from a Digital Camera](#)

- You can use non-Canon genuine art paper. For details, access our website. You cannot print in the top and bottom 1.38 inch (35 mm) margins of the paper (in the printing direction).

➡ [Sizes for Art Paper](#)

➡ [Before Printing on Art Paper](#)

## Page Sizes

You can use the following page sizes.

### ▶▶▶ Note

- Printing on the following paper sizes from a digital camera is not supported.
  - B4, B5, A5, Legal, 11" x 17" (279.4 x 431.8 mm), and Envelopes

### Standard sizes:

- Letter
- Legal
- 11" x 17" (279.4 x 431.8 mm)
- A5
- A4
- A3
- A3+
- B5
- B4
- 4" x 6" (10 x 15 cm)
- 5" x 7" (13 x 18 cm)
- 8" x 10" (20 x 25 cm)
- 10" x 12" (25 x 30 cm)
- Envelope DL
- Envelope Com 10

### Non-standard sizes:

You can print on non-standard size paper within the following ranges.

- Minimum size: 3.50 x 5.00 inches (89.0 x 127.0 mm)
- Maximum size: 12.95 x 26.61 inches (329.0 x 676.0 mm)

## Paper Weight

You can use paper in the following weight range.

- 17 to 28 lb (64 to 105 g /m<sup>2</sup>) (plain paper except for Canon genuine paper)

\* You can use non-Canon genuine specialty paper that is up to 53 lb (200 g /m<sup>2</sup>).

Do not use heavier or lighter paper (except for Canon genuine paper), as it could jam in the printer.

## Notes on Storing Paper

- Take out only the necessary number of paper from the package, just before printing.

- To avoid curling, when you do not print, put unused paper back into the package and keep it on a level surface. And also, store it avoiding heat, humidity, and direct sunlight.

# Paper Load Limit

## Commercially Available Papers

Media Name	Rear Tray	Paper Output Tray
Plain Paper (including recycled paper)* <a href="#">1</a>	Approx. 150 sheets	Approx. 50 sheets
Envelopes	10 envelopes	<a href="#">*2</a>

## Canon Genuine Papers

### ▶▶▶ Note

- We recommend that you remove the previously printed sheet from the paper output tray before continuously printing to avoid blurs and discoloration (except for High Resolution Paper <HR-101N>).

### Paper for printing photos:

Media Name <Model No.>	Rear Tray
Photo Paper Pro Platinum <PT-101> <a href="#">*3</a>	1 sheet: A3+ 10 sheets: A3, A4, Letter, and 8" x 10" (20 x 25 cm) 20 sheets: 4" x 6" (10 x 15 cm)
Glossy Photo Paper "Everyday Use" <GP-501/GP-601> <a href="#">*3</a>	1 sheet: A3+ 10 sheets: A4 and Letter 20 sheets: 4" x 6" (10 x 15 cm)
Photo Paper Glossy <GP-601> <a href="#">*3</a>	1 sheet: A3+ 10 sheets: A4 and Letter 20 sheets: 4" x 6" (10 x 15 cm)
Photo Paper Plus Glossy II <PP-201> <a href="#">*3</a>	1 sheet: A3+ 10 sheets: A3, A4, Letter, 5" x 7" (13 x 18 cm), and 8" x 10" (20 x 25 cm) 20 sheets: 4" x 6" (10 x 15 cm)
Photo Paper Pro Luster <LU-101> <a href="#">*3</a>	1 sheet: A3+ 10 sheets: A3, A4, and Letter
Photo Paper Plus Semi-gloss <SG-201> <a href="#">*3</a>	1 sheet: A3+ and 10" x 12" (25 x 30 cm) 10 sheets: A3, A4, Letter, 5" x 7" (13 x 18 cm), and 8" x 10" (20 x 25 cm) 20 sheets: 4" x 6" (10 x 15 cm)
Matte Photo Paper <MP-101>	1 sheet: A3+ 10 sheets: A3, A4, and Letter 20 sheets: 4" x 6" (10 x 15 cm)

### Paper for printing business documents:

Media Name <Model No.>	Rear Tray	Paper Output Tray
------------------------	-----------	-------------------

High Resolution Paper <HR-101N>	20 sheets: A3+ 50 sheets: A3 80 sheets: A4 and Letter	20 sheets: A3+ and A3 50 sheets: A4 and Letter
---------------------------------	---	---

**Paper for creating your own prints:**

Media Name <Model No.>	Rear Tray
T-Shirt Transfers <TR-301>	1 sheet
Photo Stickers <PS-101>	1 sheet

\*1 Proper feeding of paper may not be possible at the maximum capacity depending on the type of paper or environmental conditions (either very high or low temperature or humidity). In such cases, reduce the number of paper you load at a time to less than half.

\*2 We recommend that you remove the previously printed envelope from the paper output tray before continuously printing to avoid blurs and discoloration.

\*3 When loading paper in stacks, the print side may become marked as it is fed or paper may not feed properly. In this case, load one sheet at a time.

**▶▶ Note**

- When using non-Canon genuine art paper, load one sheet at a time in the rear tray.

## Media Types You Cannot Use

Do not use the following types of paper. Using such paper will cause not only unsatisfactory results, but also the printer to jam or malfunction.

- Folded, curled, or wrinkled paper
- Damp paper
- Paper that is too thin (weighing less than 17 lb (64 g /m<sup>2</sup>))
- Paper that is too thick (plain paper weighing more than 28 lb (105 g /m<sup>2</sup>), except for Canon genuine paper)
  - \* However, you can use non-Canon genuine specialty paper that is up to 53 lb (200 g /m<sup>2</sup>)
- Paper thinner than a postcard, including plain paper or notepad paper cut to a small size (when printing on paper smaller than A5)
- Picture postcards
- Postcards affixed with photos or stickers
- Envelopes with a double flap
- Envelopes with an embossed or treated surface
- Envelopes whose gummed flaps are already moistened and adhesive
- Any type of paper with holes
- Paper that is not rectangular
- Paper bound with staples or glue
- Paper with adhesives
- Paper decorated with glitter, etc.

## Before Printing on Art Paper

When using art paper, dust is liable to be generated. It is therefore recommended that paper dust be removed on art paper just before printing.

**You will need a soft hair brush (or similar brush used to clean office automation equipment).**

The wider the brush, the more effective it will be.



OK - soft brush made from material such as polypropylene, polyethylene, horse hair or goat hair.

### ►► Important

- Be sure not to use brushes as shown below. The printing surface may be damaged.



Not OK - brush made from hard material, cloth or washcloth, sticky and abrasive materials.

### Paper dust removal procedure:

1. Check that the brush is not wet and free from dust or dirt.
2. Brush the overall printing surface carefully in one direction.

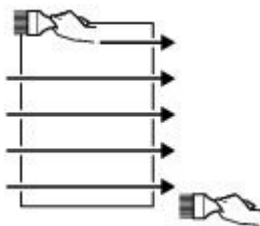

### ►► Important

- Be sure to brush all the way across the paper; do not start brushing at the middle or stop halfway.
- Be careful not to touch the printing surface as much as possible.

3. To complete the removal of paper dust, brush the paper in the other direction from top to bottom.





## **Printing Area**

- ▶ **Printing Area**
- ▶ **Other Sizes than Letter, Legal, Envelopes**
- ▶ **Letter, Legal**
- ▶ **Sizes for Art Paper**
- ▶ **Envelopes**
- ▶ **Printable Discs**

## Printing Area

To ensure the best print quality, the printer allows a margin along each edge of media. The actual printable area will be the area inside these margins.

Recommended printing area  : Canon recommends that you print within this area.

Printable area  : The area where it is possible to print. However, printing in this area can affect the print quality or the paper feed precision.

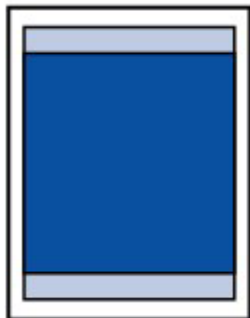

### ▶▶ Note

- By selecting Borderless Printing option, you can make prints with no margins.
- When performing Borderless Printing, slight cropping may occur at the edges since the printed image is enlarged to fill the whole page.
- For Borderless Printing, use the following paper:
  - Photo Paper Pro Platinum <PT-101>
  - Glossy Photo Paper "Everyday Use" <GP-501/GP-601>
  - Photo Paper Glossy <GP-601>
  - Photo Paper Plus Glossy II <PP-201>
  - Photo Paper Pro Luster <LU-101>
  - Photo Paper Plus Semi-gloss <SG-201>
  - Matte Photo Paper <MP-101>

Performing Borderless Printing on any other type of paper may substantially reduce printing quality and/or result in printouts with altered color hues.

Borderless Printing on plain paper may result in printouts with reduced quality. Use them only for test printing.

- Borderless Printing is not available for legal, A5, B5, or B4 sized paper, envelopes, or non-Canon genuine art paper.
- Depending on the type of paper, Borderless Printing may reduce the print quality at the top and bottom edges of the paper or cause these parts to become smudged.

## Other Sizes than Letter, Legal, Envelopes

Size	Printable Area (width x height)
A5	5.56 x 7.95 inches (141.2 x 202.0 mm)
A4	8.00 x 11.38 inches (203.2 x 289.0 mm)
A3	11.43 x 16.22 inches (290.2 x 412.0 mm)
A3+	12.69 x 18.70 inches (322.2 x 475.0 mm)
B5	6.90 x 9.80 inches (175.2 x 249.0 mm)
B4	9.85 x 14.02 inches (250.2 x 356.0 mm)
4" x 6" (10 x 15 cm)	3.73 x 5.69 inches (94.8 x 144.4 mm)
5" x 7" (13 x 18 cm)	4.73 x 6.69 inches (120.2 x 169.8 mm)
8" x 10" (20 x 25 cm)	7.73 x 9.69 inches (196.4 x 246.0 mm)
10" x 12" (25 x 30 cm)	9.73 x 11.69 inches (247.2 x 296.8 mm)
11" x 17" (279.4 x 431.8 mm)	10.73 x 16.69 inches (272.6 x 423.8 mm)

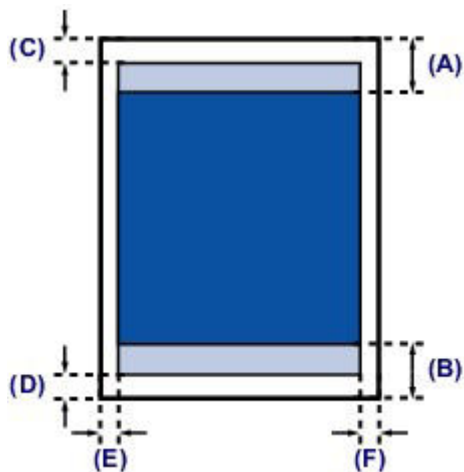

 Recommended printing area

(A) 1.59 inches (40.4 mm)

(B) 1.47 inches (37.4 mm)

 Printable area

(C) 0.12 inch (3.0 mm)

(D) 0.20 inch (5.0 mm)

(E) 0.13 inch (3.4 mm)

(F) 0.13 inch (3.4 mm)

## Letter, Legal

Size	Printable Area (width x height)
Letter	8.00 x 10.69 inches (203.2 x 271.4 mm)
Legal	8.00 x 13.69 inches (203.2 x 347.6 mm)

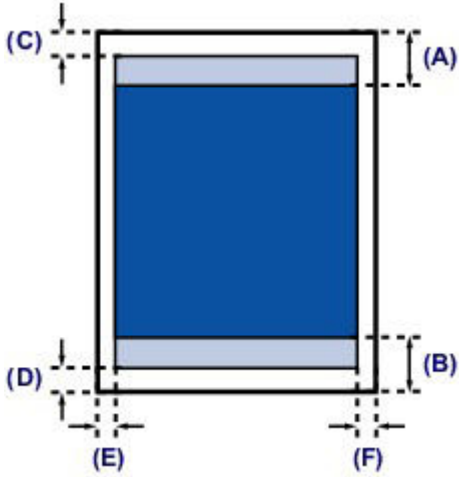

 Recommended printing area

(A) 1.59 inches (40.4 mm)

(B) 1.47 inches (37.4 mm)

 Printable area

(C) 0.12 inch (3.0 mm)

(D) 0.20 inch (5.0 mm)

(E) 0.25 inch (6.4 mm)

(F) 0.25 inch (6.3 mm)

## Sizes for Art Paper

A limit is set to prevent printing along a 1.38 inch (35 mm) margin on the top and bottom edges when a paper size for art paper is selected in the printer driver. We recommend checking the printing area in the preview screen before printing.

### A4/A3/A3+

Size	Recommended Printing Area (width x height)
A4 (art paper, 1.38 inch (35 mm) margin)	8.00 x 8.94 inches (203.2 x 227.0 mm)
A3 (art paper, 1.38 inch (35 mm) margin)	11.43 x 13.78 inches (290.2 x 350.0 mm)
A3+ (art paper, 1.38 inch (35 mm) margin)	12.69 x 16.26 inches (322.2 x 413.0 mm)

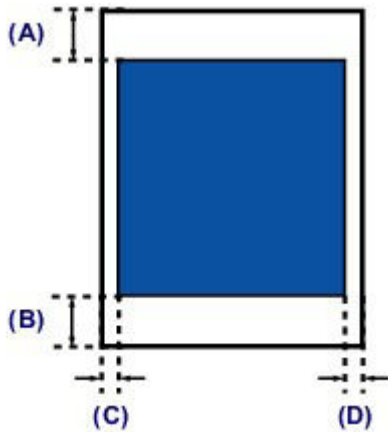

Recommended printing area

(A) 1.38 inches (35.0 mm)

(B) 1.38 inches (35.0 mm)

(C) 0.13 inch (3.4 mm)

(D) 0.13 inch (3.4 mm)

### Letter

Size	Recommended Printing Area (width x height)
Letter (art paper, 1.38 inch (35 mm) margin)	8.00 x 8.24 inches (203.2 x 209.4 mm)

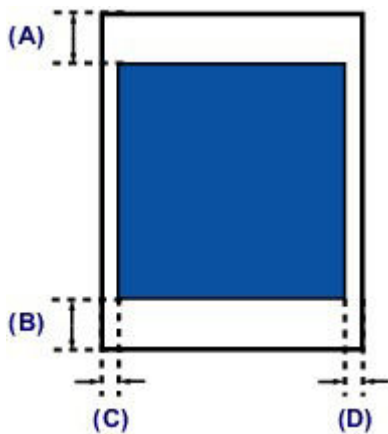

Recommended printing area

(A) 1.38 inches (35.0 mm)

- (B) 1.38 inches (35.0 mm)
- (C) 0.25 inch (6.4 mm)
- (D) 0.25 inch (6.3 mm)

# Envelopes

Size	Recommended Printing Area (width x height)
Envelope DL	3.88 x 7.06 inches (98.8 x 179.6 mm)
Envelope Com 10	3.68 x 7.90 inches (93.5 x 200.9 mm)

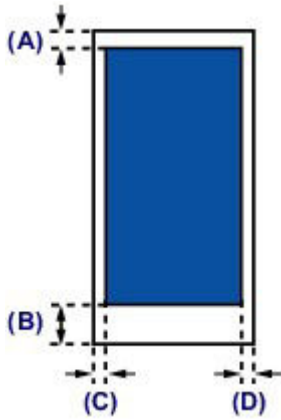

 Recommended printing area

- (A) 0.12 inch (3.0 mm)
- (B) 1.47 inches (37.4 mm)
- (C) 0.22 inch (5.6 mm)
- (D) 0.22 inch (5.6 mm)



## Printable Discs

The printing area of the printable disc is from 0.67 inch (17 mm) of the internal diameter to 0.04 inch (1 mm) from the external diameter of the printing surface.

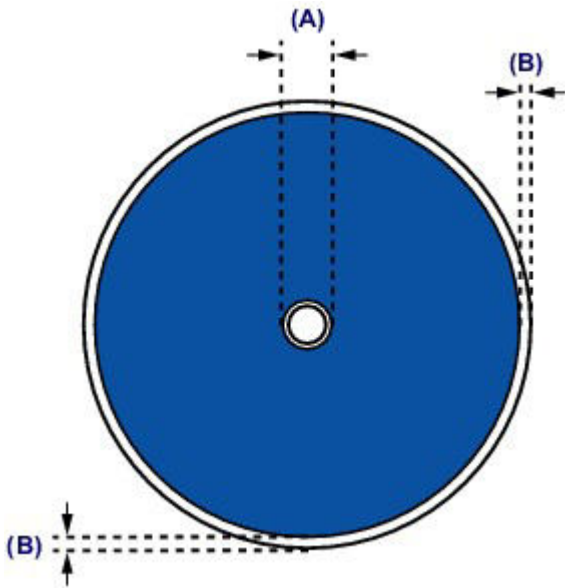

 Recommended printing area

(A) 0.67 inch (17.0 mm)

(B) 0.04 inch (1.0 mm)

## **Placing a Printable Disc**

- ▶ **Cautions When Printing on a Printable Disc**
- ▶ **Before Placing a Printable Disc**
- ▶ **Placing a Printable Disc**
- ▶ **Removing a Printable Disc**

## Cautions When Printing on a Printable Disc

- Be sure to use the disc tray supplied with this printer. It has a "L" on the upper side.
- Do not print on printable discs that are not compatible with inkjet printing. The ink will not dry and may cause problems with the disc itself or devices which the disc is loaded onto.
- Do not print on the printable discs' recording surface. Doing so will make data recorded on discs unreadable.
- Hold the printable discs by their edges. Do not touch either the label surface (printing surface) or recording surface.
- Remove any dirt from the disc tray before placing printable discs on the disc tray. Loading discs in a dirty disc tray may scratch the recording surface of the discs.
- After printing, allow the printing surface of the disc to dry naturally. Do not use hairdryers or expose the disc to direct sunlight to dry the ink. Do not touch the printing surface until the ink has dried.
- Do not attach the disc tray while the printer is in operation.
- Do not remove the disc tray while printing on printable discs. Doing so may damage the printer, the disc tray, or the disc.
- Do not get dirt or scratches on the reflectors of the disc tray. The printer may not be able to recognize loading of the printable disc, or printing may become misaligned. If the reflectors on the disc tray become dirty, wipe the reflector clean with a soft and dry cloth, taking care not to scratch the plate.
- Be sure not to bend or peel off the transparency film on the leading edge of the disc tray. The disc tray may not attach properly.
- The disc tray may become dirty if software other than My Image Garden is used.
- Always close the disc tray guide after printing on printable discs.
- To keep the print quality at an optimal level, it is recommended to stop printing discs once every ten discs when printing more than ten discs continuously.

To stop the printing operation, detach the disc tray from the printer, then close the disc tray guide. After approximately three minutes have elapsed, open the disc tray guide, attach the disc tray to the printer, then resume printing.

## Before Placing a Printable Disc

The following items are needed to print onto the printable disc:

- disc tray (supplied with the printer)



\* Use the disc tray with "L" on the surface.

The disc tray may be stored on the back of the printer.

➔ [Storing the disc tray](#)

- 4.72 inches (12 cm) printable disc



Obtain a printable disc with a label surface compatible with inkjet printing.

### ▶▶▶ Note

- A "printable disc" differs from regular disc (BD/DVD/CD, etc.) in that its label surface has been specially processed to be printed on by an inkjet printer.

## Placing a Printable Disc

To print onto a printable disc, place it on the disc tray supplied with the printer, then insert it into the printer.

### »» Important

- Do not attach the disc tray until the message asking you to load the printable disc is displayed. Doing so can damage the printer.

1. Open the front cover (A) gently.
2. When the message asking you to load the printable disc is displayed, open the disc tray guide (B).

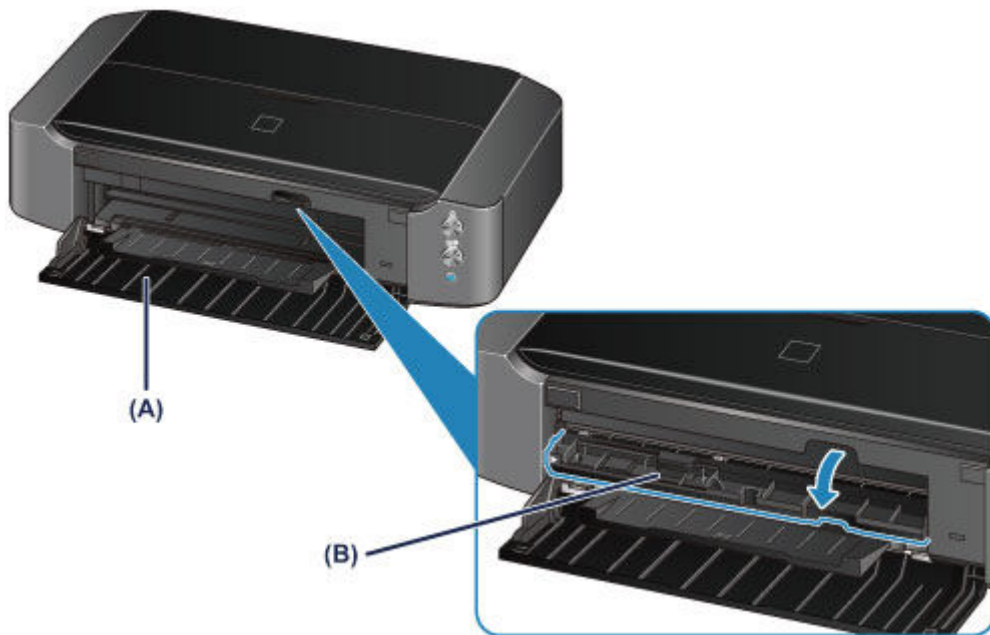

3. Place the printable disc with the printable surface facing up.

### »» Important

- Make sure that there is no dirt on the disc tray before placing a printable disc on the disc tray.
- When placing a printable disc on the disc tray, do not touch the printing surface of the disc or the reflectors (C) on the disc tray.

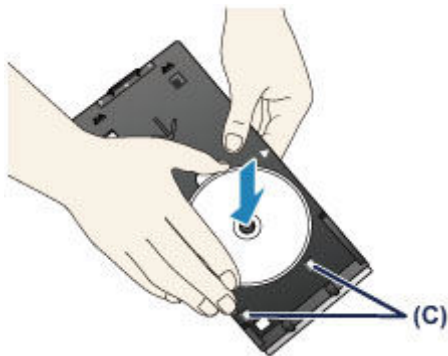

4. Attach the disc tray to the printer.

## ▶▶▶ Important

- Do not attach the disc tray while the printer is operating (the **POWER** lamp is flashing white).

## ▶▶▶ Note

- The disc tray may be ejected after a specified period of time has elapsed. In this case, follow the on-screen instructions to attach the disc tray.

1. Place the disc tray on the disc tray guide.
2. Insert the disc tray straight until the arrow (▶) on the disc tray guide is almost aligned with the arrow (◀) on the disc tray.

## ▶▶▶ Important

- Do not insert the disc tray beyond the arrow (▶) on the disc tray guide.

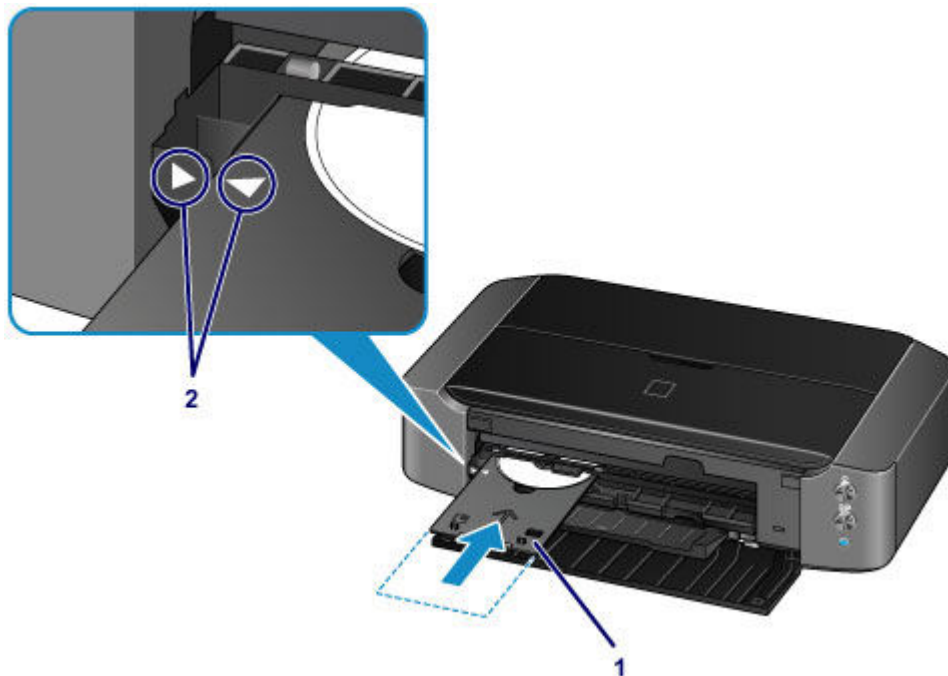

## Removing a Printable Disc

1. Pull out the disc tray.

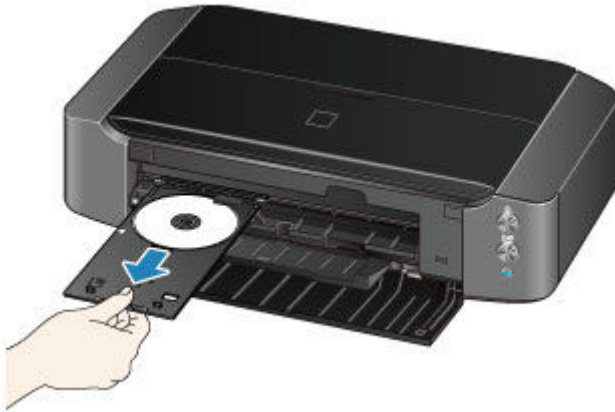

2. Close the disc tray guide.

### ►►► Important

- If the disc tray guide is opened, you cannot print on paper as it will not feed properly. Make sure that the disc tray guide is closed.

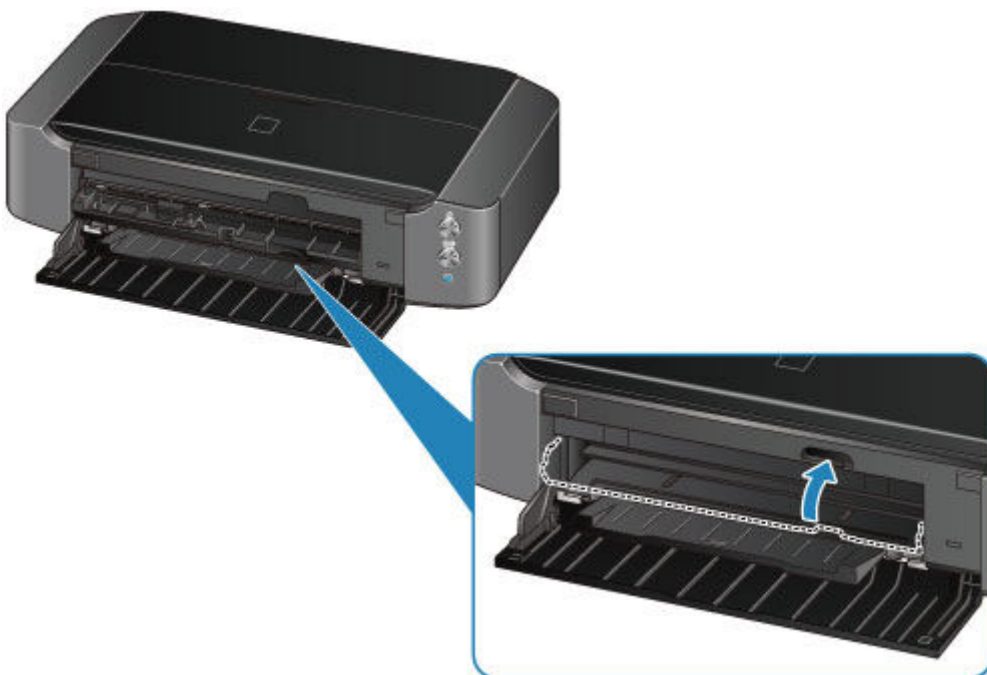

3. Remove the printable disc from the disc tray.

### ►►► Important

- Do not touch the printing surface when removing the disc from the disc tray.

### ►►► Note

- Dry the printing surface sufficiently before removing the disc. If you see printing on the disc tray or the transparent parts on inner or outer diameter of the printable disc, wipe them off after the printing surface has dried.

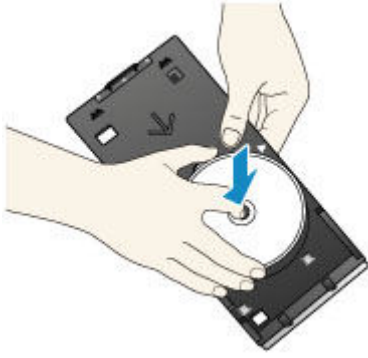

## Storing the disc tray

When not using the disc tray, hook it onto the hooks on the back of the printer.

Hook disc mounting side in, as shown in the figure.

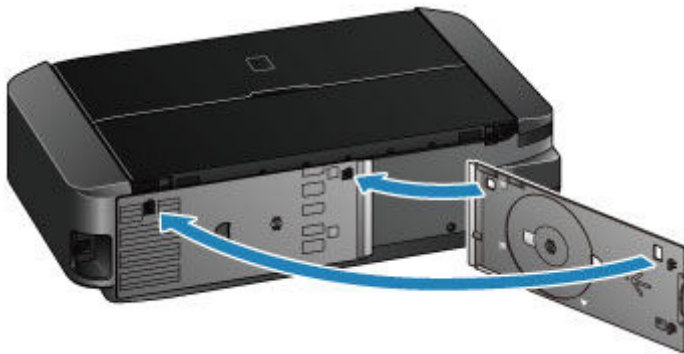

### »» Important

- If the disc tray is bent, it may become unusable. Be sure to store it on the back of the printer.
- When storing the disc tray, be sure not to bend or peel off the transparency film on its leading edge.



## Replacing an Ink Tank

- ▶ Replacing an Ink Tank
- ▶ Checking the Ink Status

# Replacing an Ink Tank

When remaining ink cautions or errors occur, the **Alarm** lamp will flash orange to inform you of the error. Count the number of flashes and take appropriate action.

➔ [If an Error Occurs](#)

## ▶▶▶ Note

- For information on the compatible ink tank, refer to the printed manual: *Safety and Important Information*.
- If print results become faint or white streaks appear despite sufficient ink levels, see [Maintenance Procedure](#).

## Replacing Procedure

When you need to replace an ink tank, follow the procedure below.

## ▶▶▶ Important

- If you remove an ink tank, replace it immediately. Do not leave the printer with the ink tank removed.
- Use a new ink tank for replacement. Installing a used ink tank may cause the nozzles to clog. Furthermore, with such an ink tank, the printer will not be able to inform you when to replace the ink tank properly.
- Once an ink tank has been installed, do not remove it from the printer and leave it out in the open. This will cause the ink tank to dry out, and the printer may not operate properly when it is reinstalled. To maintain optimal printing quality, use an ink tank within six months of first use.

## ▶▶▶ Note

- Color ink may be consumed even when printing a black-and-white document or when black-and-white printing is specified.  
  
Every ink is also consumed in the standard cleaning and deep cleaning of the print head, which may be necessary to maintain the performance of the printer. When an ink tank is out of ink, replace it immediately with a new one.  
  
➔ [Useful Information about Ink](#)

1. Make sure that the power is turned on.
2. Open the top cover.  
  
The print head holder moves to the replacement position.



### **⚠ Caution**

- Do not hold the print head holder to stop or move it forcibly. Do not touch the print head holder until it stops completely.

### **➤➤ Important**

- Do not place any object on the top cover. It will fall into the rear tray when the top cover is opened and cause the printer to malfunction.
- Do not touch the metallic parts or other parts inside the printer.
- If the top cover is left open for more than 10 minutes, the print head holder moves to the right. In this case, close and reopen the top cover.

### 3. Remove the ink tank with the lamp flashing fast.

Push the tab (A) and lift the ink tank to remove.

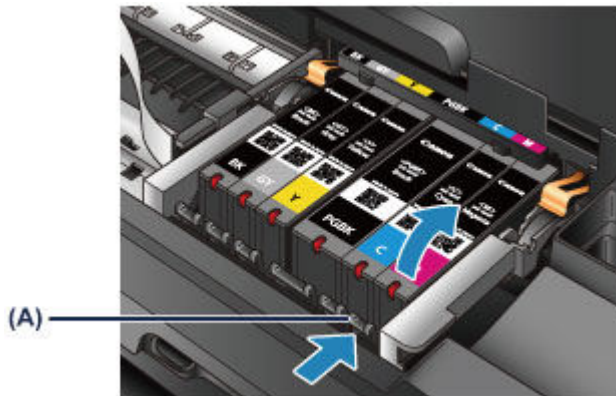

### **➤➤ Important**

- Do not touch other parts besides the ink tanks.
- Handle the ink tank carefully to avoid staining of clothing or the surrounding area.
- Discard the empty ink tank according to the local laws and regulations regarding disposal of consumables.

### **➤➤ Note**

- Do not remove two or more ink tanks at the same time. Be sure to replace ink tanks one by one when replacing two or more ink tanks.
- For details on ink lamp flashing speed, see [Checking the Ink Status with the Ink Lamps](#).

### 4. Prepare a new ink tank.

1. Take a new ink tank out of its package, remove the orange tape (1) completely, then remove the protective film (2) completely.

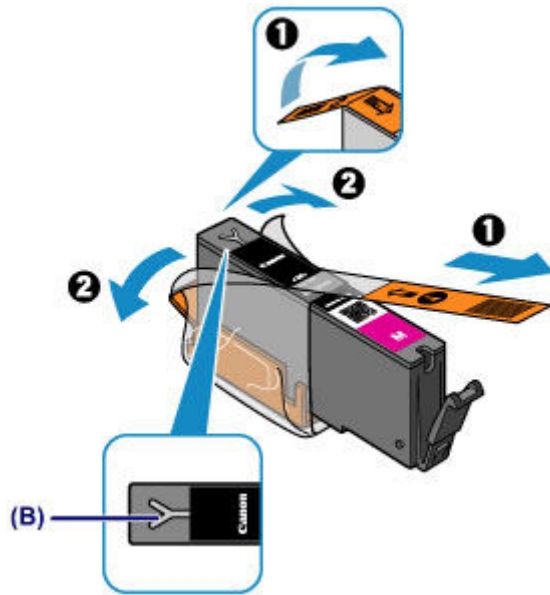

### ►► Important

- Handle an ink tank carefully. Do not drop or apply excessive pressure to it.
- If the orange tape remains on the Y-shape air hole (B), ink may splash or the printer may not print properly.

2. Hold the ink tank with the orange protective cap (C) pointing up while being careful not to block the Y-shape air hole (B).

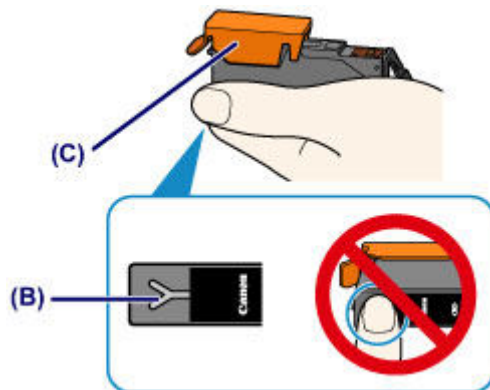

3. Lift up the tab on the orange protective cap (C) to remove it off GENTLY.

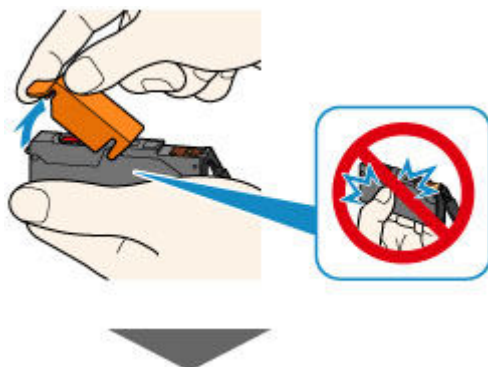

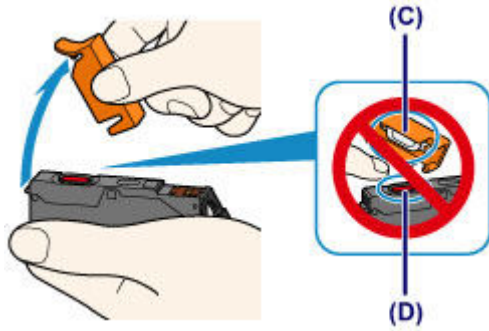

### ►► Important

- Do not push the sides of the ink tank. If you push the sides of the ink tank with the Y-shape air hole (B) blocked, ink may splash.
- Do not touch the inside of the orange protective cap (C) or the open ink port (D). The ink may stain your hands if you touch them.
- Do not reattach the protective cap (C) once you have removed it. Discard it according to the local laws and regulations regarding disposal of consumables.

## 5. Install the new ink tank.

1. Insert the front end of the ink tank into the print head at a slant.

Make sure that the position of the ink tank matches the label.

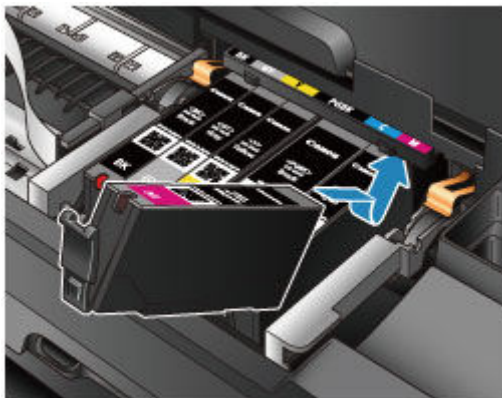

2. Press on the top of the ink tank until the ink tank snaps firmly into place.

Make sure that the ink lamp lights up red.

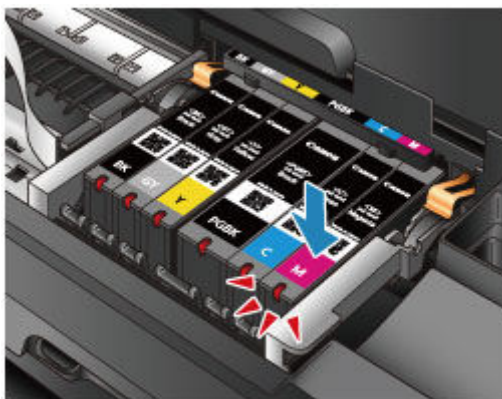

### ►► Important

- You cannot print if the ink tank is installed in the wrong position. Be sure to install the ink tank in the correct position according to the label on the print head holder.

- You cannot print unless all the ink tanks are installed. Be sure to install all the ink tanks.

6. Close the top cover.

**▶▶▶ Note**

- If the **Alarm** lamp still flashes orange after the top cover is closed, take appropriate action.
  - ➔ [If an Error Occurs](#)
- When you start printing after replacing the ink tank, the printer starts cleaning the print head automatically. Do not perform any other operations until the printer completes the cleaning of the print head. While cleaning is in progress, the **POWER** lamp is flashing white.
- If the print head is out of alignment, as indicated by misaligned printed ruled lines or similar symptoms, [align the print head](#).

## Checking the Ink Status

- ▶ **Checking the Ink Status with the Ink Lamps**

You can also check the ink status on the computer screen.

- ▶ **Checking the Ink Status from Your Computer**

# Checking the Ink Status with the Ink Lamps

1. Make sure that the power is turned on.
2. Open the top cover.

➔ [Replacing Procedure](#)

3. Check the ink lamp.

Close the top cover after checking the ink lamp status.

➔ [Replacing Procedure](#)

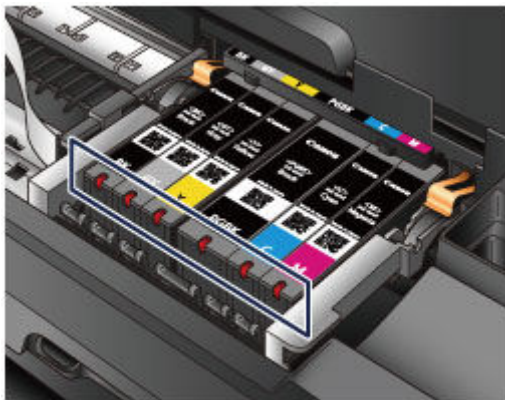

- The ink lamp is on.  
The ink tank is correctly installed.
- The ink lamp is flashing.

### Flashing slowly (at around 3-second intervals)



Ink tank is running low. Prepare a new ink tank.

### ➤➤ Note

- When printing on A3 size or larger paper, ink may run out during printing. This may cause blurred print results or horizontal white streaks.

### Flashing fast (at around 1-second intervals)



- The ink tank is installed in the wrong position.

Or

- The ink has run out.

Make sure that the ink tank is installed in the correct position as indicated by the label on the print head holder. If the position is correct but the lamp flashes, there has been an error and the printer cannot print. Check the **Alarm** lamp on the printer.

➔ [If an Error Occurs](#)

- The ink lamp is off.



The ink tank is not installed properly or the function for detecting the remaining ink level is disabled. If the ink tank is not firmly in place, make sure that the orange protective cap has been removed from the bottom of the ink tank, then press on the top of the ink tank until the ink tank clicks into place.

If the ink lamp is still off after reinstalling the ink tank, there has been an error and the printer cannot print. Check the **Alarm** lamp on the printer.

➔ [If an Error Occurs](#)

## ▶▶▶ Note

- You can also check the ink status on the computer screen.

➔ [Checking the Ink Status from Your Computer](#)

## **Maintenance**

- **When Printing Becomes Faint or Colors Are Incorrect**
- **Performing Maintenance from a Computer**
- **Cleaning the Printer**

## **When Printing Becomes Faint or Colors Are Incorrect**

- **Maintenance Procedure**
- **Printing the Nozzle Check Pattern**
- **Examining the Nozzle Check Pattern**
- **Cleaning the Print Head**
- **Aligning the Print Head**

# Maintenance Procedure

If print results are blurred, colors are not printed correctly, or print results are unsatisfactory (e.g. misaligned printed ruled lines), perform the maintenance procedure below.

## ▶▶▶ Important

- Do not rinse or wipe the print head and ink tank. This can cause trouble with the print head and ink tank.

## ▶▶▶ Note

- Make sure that the orange protective tape does not remain on the ink tank.

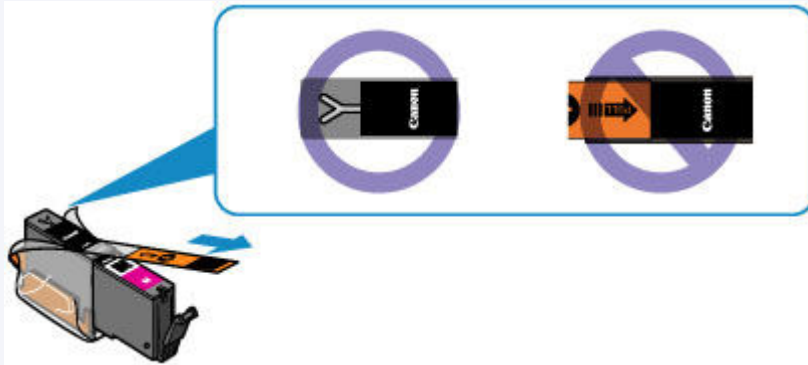

- Open the top cover and make sure that the lamp on the ink tank is lit red. If the lamp is flashing or off, take appropriate action.
  - ➔ [Checking the Ink Status with the Ink Lamps](#)
- Increasing the print quality in the printer driver settings may improve the print result.
  - ➔ [Changing the Print Quality and Correcting Image Data](#)

## When the Print Results Are Blurred or Uneven:

**Step1** Print the nozzle check pattern.

From the printer

- ➔ [Printing the Nozzle Check Pattern](#)

From the computer

- ➔ [Use Your Computer to Print a Nozzle Check Pattern](#)

**Step2** [Examine the nozzle check pattern.](#)

If there are missing lines or horizontal white streaks in the pattern:



**Step3** Clean the print head.

From the printer

- ➔ [Cleaning the Print Head](#)

From the computer

➔ [Cleaning the Print Heads from Your Computer](#)

After cleaning the print head, print and examine the nozzle check pattern: ➔ [Step 1](#)

**If the problem is not resolved after performing from step 1 to step 3 twice:**



**Step 4** Clean the print head deeply.

From the computer

➔ [Cleaning the Print Heads from Your Computer](#)

**▶▶▶ Note**

- When you have performed the procedure until step 4 and the problem has not been resolved, turn off the power and clean the print head deeply again after 24 hours.  
If the problem is still not resolved, the print head may be damaged. Contact the service center.

**When the Print Results Are Not Even such as the Ruled Lines Are Misaligned:**

**Step** Align the print head.

From the printer

➔ [Aligning the Print Head](#)

From the computer

➔ [Aligning the Print Head Position from Your Computer](#)

## Printing the Nozzle Check Pattern

Print the nozzle check pattern to determine whether the ink ejects properly from the print head nozzle.

### Note

- If the remaining ink level is low, the nozzle check pattern will not be printed correctly. [Replace the ink tank](#) whose ink is low.

**You need to prepare: a sheet of A4 or Letter-sized plain paper**

1. Make sure that the power is turned on.
2. Load a sheet of A4 or Letter-sized plain paper in the rear tray.
3. Open the front cover gently, then pull out the paper output tray.

### Important

- If the disc tray guide is open, close it.

4. Hold down the **RESUME/CANCEL** button until the **POWER** lamp flashes white twice, then release it immediately.

The nozzle check pattern will be printed.

Do not perform any other operations until the printer completes the printing of the nozzle check pattern.

5. [Examine the nozzle check pattern.](#)

# Examining the Nozzle Check Pattern

Examine the nozzle check pattern, and clean the print head if necessary.

1. Check if there are missing lines in the pattern (A) or horizontal white streaks in the pattern (B).

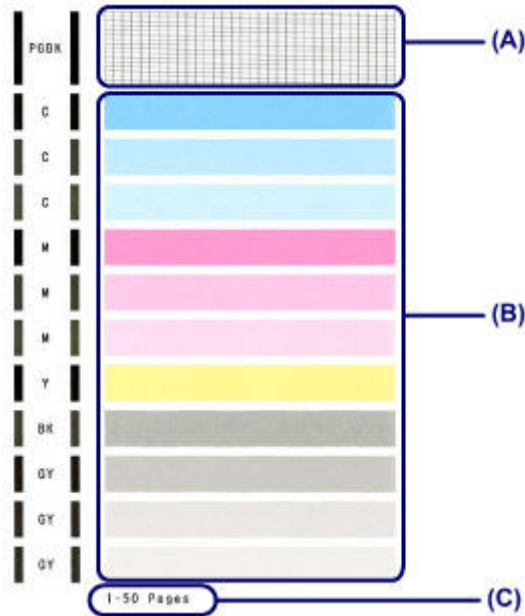

(C) Number of sheets printed so far

**If there are missing lines in the pattern (A):**

[Cleaning the print head](#) is required.



(D) Good

(E) Bad (lines are missing)

**If there are horizontal white streaks in the pattern (B):**

[Cleaning the print head](#) is required.



(F) Good

(G) Bad (horizontal white streaks are present)

## ►► Note

- The total number of sheets printed so far is shown in increments of 50 sheets on the printout of the nozzle check pattern.

## Cleaning the Print Head

Clean the print head if lines are missing or if horizontal white streaks are present in the printed nozzle check pattern. Cleaning unclogs the nozzles and restores the print head condition. Cleaning the print head consumes ink, so clean the print head only when necessary.

1. Make sure that the power is turned on.
2. Hold down the **RESUME/CANCEL** button until the **POWER** lamp flashes white once, then release it immediately.

The printer starts cleaning the print head.

The cleaning will be complete when the **POWER** lamp lights white after flashing.

Do not perform any other operations until the printer completes the cleaning of the print head. This takes about 2 minutes.

3. Check the print head condition.

[Print the nozzle check pattern](#) to check the print head condition.

### ▶▶ Note

- If the problem is not resolved after cleaning the print head twice, clean the print head deeply.
  - ➔ [Cleaning the Print Heads from Your Computer](#)



## Aligning the Print Head

If printed ruled lines are misaligned or print results are otherwise unsatisfactory, adjust the print head position.

### ▶▶▶ Note

- If the remaining ink level is low, the print head alignment sheet will not be printed correctly. [Replace the ink tank](#) whose ink is low.

**You need to prepare: a sheet of A4 or Letter-sized plain paper (including recycled paper)\***

\* Be sure to use paper that is white and clean on both sides.

1. Make sure that the power is turned on.
2. Load a sheet of A4 or Letter-sized plain paper in the rear tray.
3. Open the front cover gently, then pull out the paper output tray.

### ▶▶▶ Important

- If the disc tray guide is open, close it.

4. Hold down the **RESUME/CANCEL** button until the **POWER** lamp flashes white four times, then release it immediately.

The print head alignment sheet will be printed and the print head position will be adjusted automatically.

Do not perform any other operations until the printer completes the printing of the print head alignment sheet. This takes about 2 to 3 minutes.

### ▶▶▶ Note

- If the automatic adjustment of the print head position has failed, the **Alarm** lamp flashes orange.
  - ➔ [If an Error Occurs](#)
- If the print results are still not satisfactory after adjusting the print head position as described above, adjust the print head position manually from the computer.
  - ➔ [Aligning the Print Head Position Manually from Your Computer](#)

## Performing Maintenance from a Computer

- ➔ [Cleaning the Print Heads from Your Computer](#)
- ➔ [Cleaning the Paper Feed Rollers from Your Computer](#)
- ➔ [Aligning the Print Head](#)
- ➔ [Aligning the Print Head Position from Your Computer](#)
- ➔ [Use Your Computer to Print a Nozzle Check Pattern](#)
- ➔ [Cleaning Inside the Printer](#)

# Cleaning the Print Heads from Your Computer

The print head cleaning function allows you to clear up clogged print head nozzle. Perform print head cleaning if printing is faint or a specific color fails to print, even though there is enough ink.

The procedure for cleaning the print head is as follows:



## Cleaning

1. Open the [printer driver setup window](#)

2. Click **Cleaning** on the **Maintenance** tab

When the **Print Head Cleaning** dialog box opens, select the ink group for which cleaning is to be performed.

Click **Initial Check Items** to display the items you need to check before performing cleaning.

3. Execute cleaning

Make sure that the printer is on and then click **Execute**.

Print head cleaning starts.

4. Complete cleaning

The **Nozzle Check** dialog box opens after the confirmation message.

5. Check the results

To check whether the print quality has improved, click **Print Check Pattern**. To cancel the check process, click **Cancel**.

If cleaning the head once does not resolve the print head problem, clean it once more.

## »» Important

- **Cleaning** consumes a small amount of ink.  
Cleaning the print head frequently will rapidly deplete your printer's ink supply. Consequently, perform cleaning only when necessary.



## Deep Cleaning

**Deep Cleaning** is more thorough than cleaning. Perform deep cleaning when two **Cleaning** attempts do not resolve the print head problem.

1. Open the [printer driver setup window](#)

2. Click **Deep Cleaning** on the **Maintenance** tab

When the **Deep Cleaning** dialog box opens, select the ink group for which deep cleaning is to be performed.

Click **Initial Check Items** to display the items you need to check before performing deep cleaning.

### 3. Execute deep cleaning

Make sure that the printer is on and then click **Execute**.

Click **OK** when the confirmation message appears.

Print head deep cleaning starts.

### 4. Complete deep cleaning

The **Nozzle Check** dialog box opens after the confirmation message.

### 5. Check the results

To check whether the print quality has improved, click **Print Check Pattern**. To cancel the check process, click **Cancel**.

## ►► Important

- **Deep Cleaning** consumes a larger amount of ink than **Cleaning**.  
Cleaning the print head frequently will rapidly deplete your printer's ink supply. Consequently, perform cleaning only when necessary.

## ►► Note

- If there is no sign of improvement after **Deep Cleaning**, switch off the printer, wait 24 hours, and then perform **Deep Cleaning** again. If there is still no sign of improvement, the ink may have run out or the print head may be worn. For details on the remedial action to be taken, see "[Ink Is Not Ejected](#)."

## Related Topic

- ➔ [Use Your Computer to Print a Nozzle Check Pattern](#)

# Cleaning the Paper Feed Rollers from Your Computer

Cleans the paper feed rollers. Perform feed roller cleaning when there are paper particles sticking to the paper feed rollers and paper is not fed properly.

The procedure for performing the feed roller cleaning is as follows:



## Roller Cleaning

1. Prepare the printer

Remove all sheets of paper from the rear tray.

2. Open the [printer driver setup window](#)

3. Click **Roller Cleaning** on the **Maintenance** tab

The confirmation message appears.

4. Execute paper feed roller cleaning

Make sure that the printer is on and then click **OK**.

Paper feed roller cleaning starts.

5. Complete paper feed roller cleaning

After the rollers have stopped, follow the instruction in the message, load three sheets of plain paper into the rear tray, and click **OK**.

Paper will be ejected and feed roller cleaning will be completed.

## Aligning the Print Head

When you perform head position adjustment, errors in the print head adjustment position are corrected and conditions such as color and line streaking are improved.

If the print results appear uneven because of line shifts or other conditions, adjust the position of the print head.

On this printer, you can adjust the print head either [automatically](#) or [manually](#).

# Aligning the Print Head Position from Your Computer

Print head alignment corrects the installation positions of the print head and improves deviated colors and lines.

This printer supports two head alignment methods: automatic head alignment and manual head alignment. Normally, the printer is set for automatic head alignment.

If the printing results of automatic print head alignment are not satisfactory, [perform manual head alignment](#).

The procedure for performing automatic print head alignment is as follows:

## »» Note

- If the disc tray guide is open, close it.
- The pattern is printed only in black and blue.



## Print Head Alignment

1. Open the [printer driver setup window](#)
2. Click **Print Head Alignment** on the **Maintenance** tab

The **Start Print Head Alignment** dialog box opens.

3. Load paper in the printer

Load one sheet of A4 size or Letter size plain paper into the rear tray.

## »» Note

- The number of sheets to be used differs when you select the manual head alignment.

4. Execute head alignment

Make sure that the printer is on and click **Align Print Head**.

Follow the instruction in the message.

## »» Important

- Do not open the top cover while printing is in progress.

## »» Note

- Wait until printing ends before performing other operations. Printing takes about 2 to 3 minutes to complete.
- To print and check the current setting, open the **Start Print Head Alignment** dialog box, and click **Print Alignment Value**.

# Aligning the Print Head Position Manually from Your Computer

Print head alignment corrects the installation positions of the print head and improves deviated colors and lines.

This printer supports two head alignment methods: [automatic head alignment](#) and manual head alignment. Normally, the printer is set for automatic head alignment.

If the printing results of automatic print head alignment are not satisfactory, perform manual head alignment.

The procedure for performing manual print head alignment is as follows:

## »» Note

- If the disc tray guide is open, close it.
- The pattern is printed only in black and blue.

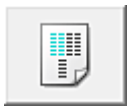

## Print Head Alignment

1. Open the [printer driver setup window](#)
2. Click **Custom Settings** on the **Maintenance** tab

The **Custom Settings** dialog box opens.

## »» Note

- If the printer is off or if communication between the printer and the computer is disabled, an error message may appear because the computer cannot collect the printer status. If this happens, click **OK** to display the most recent settings specified on your computer.

3. Switch head alignment to manual
4. Apply the settings
5. Click **Print Head Alignment** on the **Maintenance** tab

The **Start Print Head Alignment** dialog box opens.

6. Load paper in the printer  
Load three sheets of A4 size or Letter size plain paper into the rear tray.
7. Execute head alignment  
Make sure that the printer is on and click **Align Print Head**.  
Follow the instruction in the message.

## »» Important

- Do not open the top cover while printing is in progress.



8. Check the printed pattern

Enter the numbers of the patterns with the least amount of streaks in the associated boxes.

Even if the patterns with the least amount of streaks are clicked in the preview window, their numbers are automatically entered in the associated boxes.



When you have entered all the necessary values, click **OK**.

➤➤➤ **Note**

- If it is difficult to pick the best pattern, pick the setting that produces the least noticeable vertical streaks.



(A)



(B)

(A) Least noticeable vertical streaks

(B) Most noticeable vertical streaks

- If it is difficult to pick the best pattern, pick the setting that produces the least noticeable horizontal streaks.



(A)



(B)

(A) Least noticeable horizontal streaks

(B) Most noticeable horizontal streaks

9. Confirm the displayed message and click **OK**

The second pattern is printed.

➤➤➤ **Important**

- Do not open the top cover while printing is in progress.

10. Check the printed pattern

Enter the numbers of the patterns with the least noticeable horizontal stripes in the associated boxes. Even if the patterns with the least noticeable horizontal stripes are clicked in the preview window, their numbers are automatically entered in the associated boxes.

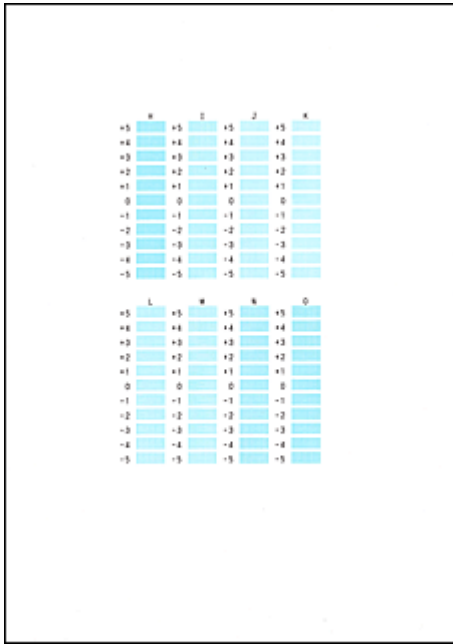

When you have entered all the necessary values, click **OK**.

**▶▶▶ Note**

- If it is difficult to pick the best pattern, pick the setting that produces the least noticeable vertical streaks.



(A)



(B)

- (A) Least noticeable vertical streaks
- (B) Most noticeable vertical streaks

11. Confirm the displayed message and click **OK**

The third pattern is printed.

**▶▶▶ Important**

- Do not open the top cover while printing is in progress.

12. Check the printed pattern

Enter the numbers of the patterns with the least noticeable horizontal stripes in the associated boxes. Even if the patterns with the least noticeable horizontal stripes are clicked in the preview window, their numbers are automatically entered in the associated boxes.

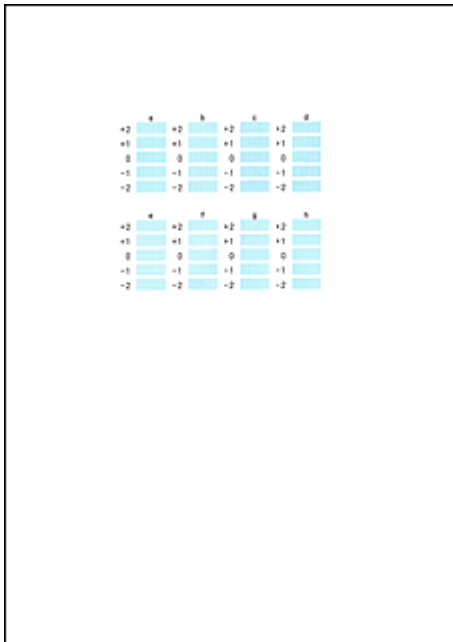

When you have entered all the necessary values, click **OK**.

➤➤ **Note**

- If it is difficult to pick the best pattern, pick the setting that produces the least noticeable horizontal stripes.



(A)



(B)

(A) Least noticeable horizontal stripes

(B) Most noticeable horizontal stripes

➤➤ **Note**

- To print and check the current setting, open the **Start Print Head Alignment** dialog box, and click **Print Alignment Value**.

# Use Your Computer to Print a Nozzle Check Pattern

The nozzle check function allows you to check whether the print head is working properly by printing a nozzle check pattern. Print the pattern if printing becomes faint, or if a specific color fails to print.

The procedure for printing a nozzle check pattern is as follows:



## Nozzle Check

1. Open the [printer driver setup window](#)

2. Click **Nozzle Check** on the **Maintenance** tab

The **Nozzle Check** dialog box opens.

Click **Initial Check Items** to display the items that you need to check before printing the nozzle check pattern.

3. Load paper in the printer

Load one sheet of A4 size or Letter size plain paper into the rear tray.

4. Print a nozzle check pattern

Make sure that the printer is on and click **Print Check Pattern**.

Printing of the nozzle check pattern begins.

Click **OK** when the confirmation message appears.

The **Pattern Check** dialog box opens.

5. Check the print result

Check the print result. When the print result is normal, click **Exit**.

If the print result is smudged or if there are any unprinted sections, click **Cleaning** to clean the print head.

## Related Topic

- ➔ [Cleaning the Print Heads from Your Computer](#)

# Cleaning Inside the Printer

Perform bottom plate cleaning before you execute duplex printing to prevent smudges on the back side of the paper.

Also perform bottom plate cleaning if ink smudges caused by something other than print data appear on the printed page.

The procedure for performing bottom plate cleaning is as follows:



## Bottom Plate Cleaning

1. Open the [printer driver setup window](#)
2. Click **Bottom Plate Cleaning** on the **Maintenance** tab

The **Bottom Plate Cleaning** dialog box opens.

3. Load paper in the printer

As instructed in the dialog box, fold the A4 size or Letter size plain paper in half lengthwise, and then unfold the sheet.

Load the paper into the rear tray in the landscape orientation with the crest of the crease facing down.

4. Perform the bottom plate cleaning

Make sure that the printer is on and then click **Execute**.

Bottom plate cleaning starts.

## **Cleaning the Printer**

- **Cleaning the Exterior of the Printer**
- **Cleaning the Inside of the Printer (Bottom Plate Cleaning)**

You can also clean the paper feed roller from a computer.

- **Cleaning the Paper Feed Rollers from Your Computer**

## Cleaning the Exterior of the Printer

Be sure to use a soft and dry cloth such as eyeglasses cleaning cloth and wipe off dirt on the surface gently. Smooth out wrinkles on the cloth if necessary before cleaning.

### »» Important

- Be sure to turn off the power and unplug the power cord before cleaning the printer.
- Do not use tissue paper, paper towels, rough-textured cloth, or similar materials for cleaning so as not to scratch the surface. Paper tissue powder or fine threads may remain inside the printer and cause problems such as print head blockage and poor printing results.
- Never use volatile liquids such as thinners, benzene, acetone, or any other chemical cleaner to clean the printer, as this may cause a malfunction or damage the surface of the printer.

## Cleaning the Inside of the Printer (Bottom Plate Cleaning)

Remove stains from the inside of the printer. If the inside of the printer becomes dirty, printed paper may get dirty, so we recommend performing cleaning regularly.

**You need to prepare: a sheet of A4 or Letter-sized plain paper\***

\* Be sure to use a new piece of paper.

1. Make sure that the power is turned on and remove any paper from the rear tray.
2. Prepare paper.
  1. Fold a single sheet of A4 or Letter-sized plain paper in half lengthwise, then unfold the paper.
  2. Load this sheet of paper sideways in the rear tray with the open side facing you.
  3. Open the front cover gently, then pull out the paper output tray.



3. Hold down the **RESUME/CANCEL** button until the **POWER** lamp flashes white five times, then release it immediately.

The paper cleans the inside of the printer as it feeds through the printer.

Check the folded parts of the ejected paper. If they are smudged with ink, perform Bottom Plate Cleaning again.

### ▶▶▶ Note

- When performing Bottom Plate Cleaning again, be sure to use a new piece of paper.

If the problem is not resolved after performing cleaning again, the protrusions inside the printer may be stained. Wipe off any ink from the protrusions using a cotton swab or the like.

### ▶▶▶ Important

- Be sure to turn off the power and unplug the power cord before cleaning the printer.



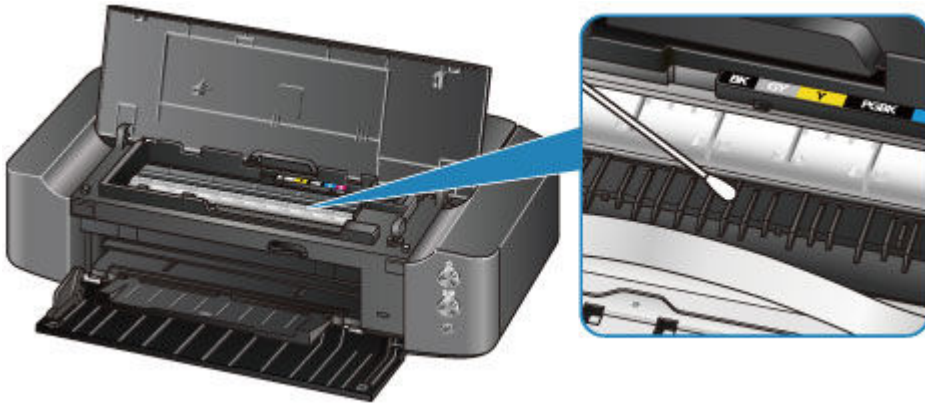

## **Changing the Printer Settings**

- ▶ **Changing Printer Settings from Your Computer**
- ▶ **Initializing the Printer Settings**

## **Changing Printer Settings from Your Computer**

- ▶ **Changing the Print Options**
- ▶ **Registering a Frequently Used Printing Profile**
- ▶ **Managing the Printer Power**
- ▶ **Reducing the Printer Noise**
- ▶ **Changing the Printer Operation Mode**

# Changing the Print Options

You can change the detailed printer driver settings for print data that is sent from an application software. Specify this option if you encounter print failures such as part of an image data being cut off.

The procedure for changing the print options is as follows:

1. Open the [printer driver setup window](#)
2. Click **Print Options...** on the **Page Setup** tab

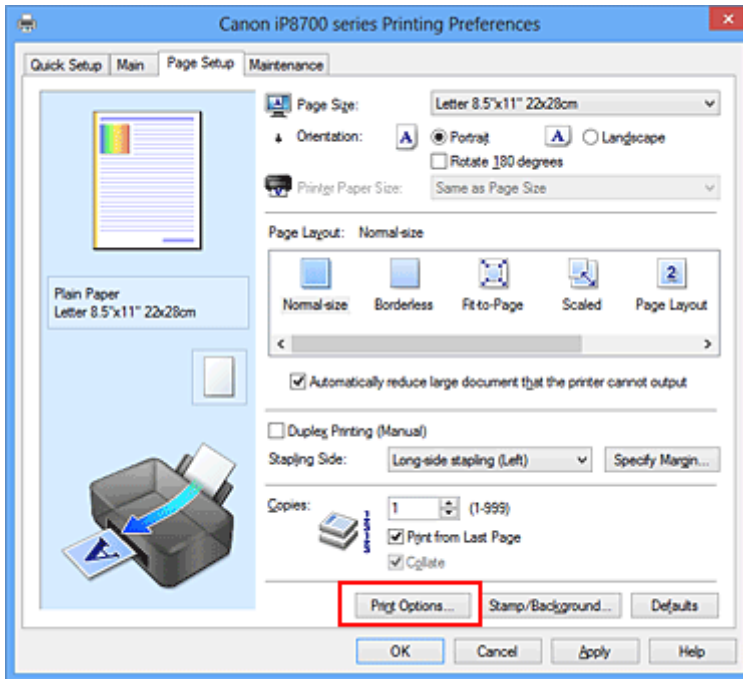

The **Print Options** dialog box opens.

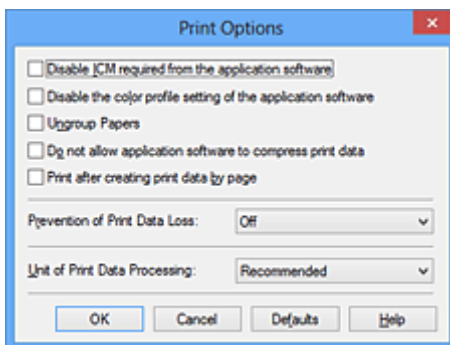

## ▶▶▶ Note

- When you use the XPS printer driver, the functions available to you are different.

3. Change the individual settings

If necessary, change the setting of each item, and then click **OK**.

The **Page Setup** tab is displayed again.

## Registering a Frequently Used Printing Profile

You can register the frequently used printing profile to **Commonly Used Settings** on the **Quick Setup** tab. Unnecessary printing profiles can be deleted at any time.

The procedure for registering a printing profile is as follows:

### Registering a Printing Profile

1. Open the [printer driver setup window](#)

2. Set the necessary items

From **Commonly Used Settings** on the **Quick Setup** tab, select the printing profile to be used and if necessary, change the settings after **Additional Features**.

You can also register necessary items on the **Main** and **Page Setup** tabs.

3. Click **Save...**

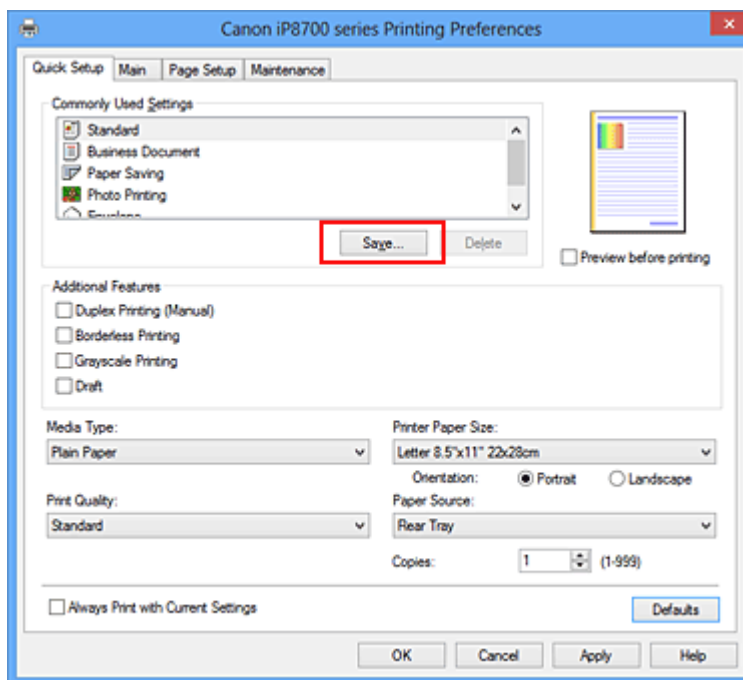

The **Save Commonly Used Settings** dialog box opens.

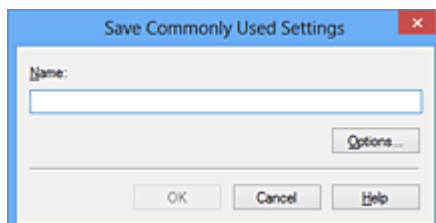

4. Save the settings

Enter a name in the **Name** field. If necessary, click **Options...**, set the items, and then click **OK**.

In the **Save Commonly Used Settings** dialog box, click **OK** to save the print settings and return to the **Quick Setup** tab.

The name and icon are displayed in **Commonly Used Settings**.

## »» Important

- To save the page size, orientation, and number of copies that was set in each sheet, click **Options...**, and check each item.

## »» Note

- When you re-install the printer driver or upgrade the printer driver version, the print settings that are already registered will be deleted from **Commonly Used Settings**.  
Registered print settings cannot be saved and preserved. If a profile is deleted, register the print settings again.

## Deleting Unnecessary Printing Profile

1. Select the printing profile to be deleted

Select the printing profile you want to delete from the **Commonly Used Settings** list on the **Quick Setup** tab.

2. Delete the printing profile

Click **Delete**. When the confirmation message appears, click **OK**.

The selected printing profile is deleted from the **Commonly Used Settings** list.

## »» Note

- Printing profiles that are registered in the initial settings cannot be deleted.

# Managing the Printer Power

This function allows you to manage the printer power from the printer driver.

The procedure for managing the printer power is as follows:



## Power Off

The **Power Off** function turns off the printer. When you use this function, you will not be able to turn the printer on from the printer driver.

1. Open the [printer driver setup window](#)
2. Execute power off

Click **Power Off** on the **Maintenance** tab. When the confirmation message appears, click **OK**.

The printer power switches off, and the **Maintenance** tab is displayed again.



## Auto Power

**Auto Power** allows you to set **Auto Power On** and **Auto Power Off**.

The **Auto Power On** function automatically turns on the printer when data is received.

The **Auto Power Off** function automatically turns off the printer when there are no operations from the printer driver or the printer for a specified period of time.

1. Open the [printer driver setup window](#)
2. Make sure that the printer is on and then click **Auto Power** on the **Maintenance** tab

The **Auto Power Settings** dialog box opens.

### ▶▶▶ Note

- If the printer is off or if communication between the printer and the computer is disabled, an error message may appear because the computer cannot collect the printer status. If this happens, click **OK** to display the most recent settings specified on your computer.

3. If necessary, complete the following settings:

#### **Auto Power On**

Specifying **Enable** from the list will turn the printer on upon receipt of print data.

#### **Auto Power Off**

Specify the time from the list. When this time lapses without any operations from the printer driver or the printer, the printer is turned off automatically.

4. Apply the settings

Click **OK**. When the confirmation message appears, click **OK**.

The **Maintenance** tab is displayed again.

The setting is enabled after this. When you want to disable this function, select **Disable** from the list according to the same procedure.

### ▶▶▶ Note

- When the printer is turned off, the Canon IJ Status Monitor message varies depending on the **Auto Power On** setting.

When the setting is **Enable**, "Printer is standing by" is displayed. When the setting is **Disable**, "Printer is offline" is displayed.

### ▶▶▶ Important

- If you connect this printer to a network and use it, you can set **Auto Power Off** but the power will not switch off automatically.



# Reducing the Printer Noise

The silent function allows you to reduce the operating noise of this printer. Select when you wish to reduce the operating noise of the printer at night, etc.

Using this function may lower the print speed.

The procedure for using the quiet mode is as follows:



## Quiet Settings

1. Open the [printer driver setup window](#)
2. Click **Quiet Settings** on the **Maintenance** tab

The **Quiet Settings** dialog box opens.

### ▶▶▶ Note

- If the printer is off or if communication between the printer and the computer is disabled, an error message may appear because the computer cannot collect the printer status.

3. Set the quiet mode

If necessary, specify one of the following items:

#### **Do not use quiet mode**

Select this option when you wish to use the printer with volume of normal operating noise.

#### **Always use quiet mode**

Select this option when you wish to reduce the operating noise of the printer.

#### **Use quiet mode during specified hours**

Select this option when you wish to reduce the operating noise of the printer during a specified period of time.

Set the **Start time** and the **End time** of the quiet mode you wish to be activated. If both are set to the same time, the quiet mode will not function.

### ▶▶▶ Important

- You can set the quiet mode from the printer or the printer driver.  
No matter how you use to set the quiet mode, the mode is applied when you perform operations from the printer or printing from the computer.
- If you specify a time for **Use quiet mode during specified hours**, quiet mode is not applied to operations (direct print, etc.) performed directly from the printer.

4. Apply the settings

Make sure that the printer is on and click **OK**.

Click **OK** when the confirmation message appears.

The settings are enabled hereafter.

**»» Note**

- The effects of the quiet mode may be less depending on the print quality settings.

# Changing the Printer Operation Mode

If necessary, switch between various modes of printer operation.

The procedure for configuring **Custom Settings** is as follows:



## Custom Settings

1. Open the [printer driver setup window](#)
2. Make sure that the printer is on, and then click **Custom Settings** on the **Maintenance** tab

The **Custom Settings** dialog box opens.

### ▶▶▶ Note

- If the printer is off or if communication between the printer and the computer is disabled, an error message may appear because the computer cannot collect the printer status. If this happens, click **OK** to display the most recent settings specified on your computer.

3. If necessary, complete the following settings:

#### **Detects a printable disc in the disc tray**

Detects whether a printable disc is loaded on the disc tray during disc label printing and displays a message if a disc is not loaded. Check this check box to print with detecting whether a printable disc is loaded.

Uncheck this check box to print without detecting whether a printable disc is loaded.

#### ▶▶▶ Important

- If you leave this check box unchecked, the printer may print to the disc tray even if a printable disc is not loaded on the disc tray. Therefore, you should check this check box under normal circumstances.
- If you load a printable disc that has already been printed onto the disc tray, the printer may detect that no printable disc is loaded on the disc tray. In this case, uncheck this check box.

#### **Prevent paper abrasion**

The printer can increase the gap between the print head and the paper during high-density printing to prevent paper abrasion.

Check this check box to prevent paper abrasion.

#### **Align heads manually**

Usually, the **Print Head Alignment** function on the **Maintenance** tab is set to automatic head alignment, but you can change it to manual head alignment.

If the printing results of automatic print head alignment are not satisfactory, [perform manual head alignment](#).

Check this check box to perform the manual head alignment. Uncheck this check box to perform the automatic head alignment.

#### **Prevent paper jam**

Check this item only if A3 plain paper jams frequently near the paper exit.

### »»» Important

- When this function is used, it takes longer to print to A3 plain paper. Also the print quality may deteriorate.

#### Rotate 90 degrees left when orientation is [Landscape]

On the **Page Setup** tab, you can change the rotation direction of the **Landscape** in the **Orientation**.

To rotate the print data 90 degrees to the left during printing, select this item. To rotate the print data 90 degrees to the right during printing, clear this item.

### »»» Important

- Do not change this setting while the print job is displayed in the print wait list. Otherwise, characters may be omitted or the layout may become corrupt.

#### Detect the paper width when printing from computer

When you print from the computer, this function identifies the paper that was loaded into this printer.

When the paper width detected by the printer differs from the width of the paper specified in **Page Size** on the **Page Setup** tab, a message is displayed.

To use paper width detection when printing from the computer, select the check box.

### »»» Important

- If you are using user-defined paper, use the **Custom Paper Size** to correctly set the size of the paper loaded in the printer.  
If an error message is displayed even though the same size that was set is loaded, clear the check box.

#### Ink Drying Wait Time

You can set the length of the printer rest time until printing of the next page begins. Moving the slider to the right increases the pause time, and moving the slider to the left decreases the time.

If the paper gets stained because the next page is ejected before the ink on the printed page dries, increase the ink drying wait time.

Reducing the ink drying wait time speeds up printing.

#### 4. Apply the settings

Click **OK** and when the confirmation message appears, click **OK**.

The printer operates with the modified settings hereafter.

## Initializing the Printer Settings

You can initialize the printer settings.

### ▶▶▶ Important

- When using the printer over wireless LAN, note that initialization erases all network settings on the printer, and printing operation from a computer over network may become impossible. To use the printer over network, perform setup with the Setup CD-ROM or perform it according to the instructions on our website.

To initialize the printer settings, press and hold the **RESUME/CANCEL** button, then release the button when the **POWER** lamp flashes white 15 times.

All the printer settings are initialized.

### ▶▶▶ Note

- You cannot initialize the current position of the print head.

## Information about Network Connection

- ▶ [Useful Information about Network Connection](#)

## **Useful Information about Network Connection**

- **Initial Values Set at Factory (Network)**
- **Connecting the Printer to the Computer Using a USB Cable**
- **When Detecting the Printers Have the Same Name during Setup**
- **Connecting to Other Computer with LAN/Changing the Connection Method from USB to LAN**
- **Printing Out Network Setting Information**

## Initial Values Set at Factory (Network)

Item	Initial Values
Enable/disable Wireless LAN	Enable
SSID	BJNPSETUP
Communication mode	Infrastructure
Wireless LAN security	Disable
IPv4 IP address	Auto setup
IPv6 IP address	Auto setup
Set printer name*	XXXXXXXXXXXXXX
Enable/disable IPv6	Enable
Enable/disable WSD (WSD settings)	Enable
Timeout setting (WSD settings)	1 minute
Enable/disable Bonjour (Bonjour settings)	Enable
Service name (Bonjour settings)	Canon iP8700 series
LPR protocol setting	Enable
PictBridge communication	Enable
Wireless LAN DRX	Enable

(\* The initial value in this item varies by the printer.)



## Connecting the Printer to the Computer Using a USB Cable

Connect the printer and the computer using a USB cable as the illustration below. The USB port is located on the rear of the printer.



## When Detecting the Printers Have the Same Name during Setup

When the printer is detected during setup, you may see multiple printers of the same name on the detection result screen.

Select a printer with checking the MAC address set to the printer against the MAC address on detection result screen.

To check the MAC address of the printer, print out the network setting information.

➡ [Printing Out Network Setting Information](#)

## **Connecting to Other Computer with LAN/Changing the Connection Method from USB to LAN**

To add the computer connecting the printer with LAN or to change the connection method between the printer and the computer from USB to LAN, perform setup with the Setup CD-ROM or perform it according to the instructions on our website.

### **Connecting to Other Computer with LAN**

To add the computer connecting the printer with LAN, perform setup with the Setup CD-ROM or perform it according to the instructions on our website.

### **Changing the Connection Method from USB to LAN**

To change the connection method between the printer and the computer from USB to LAN, perform setup with the Setup CD-ROM or perform it according to the instructions on our website.

To change the connection method to LAN while you are using the printer with USB connection, perform setup again with the Setup CD-ROM or perform it again according to the instructions on our website and select **Change Connection Method**.

# Printing Out Network Setting Information

You can print out the network settings of the printer such as its IP address and SSID.

## ▶▶▶ Important

- This print out contains valuable information about your computer. Handle it with care.

1. [Make sure that the printer is turned on.](#)
2. [Load a sheet of A4 or Letter-sized plain paper.](#)
3. Press and hold the **RESUME/CANCEL** button, then release the button when the **POWER** lamp flashes white 6 times.

The printer starts printing the network setting information.

The following information on the printer's network setting is printed out.

Item	Explanations of the item	Setting
Wireless LAN	Wireless LAN	Enable/Disable
Connection	Status of the Wireless LAN	Active/Inactive
MAC Address	MAC Address	XX:XX:XX:XX:XX:XX
SSID	SSID	SSID of the wireless LAN
Communication Mode	Communication Mode	Infrastructure
Channel	Channel	XX (1 to 13)
Encryption	Method of the Encryption	none/WEP/TKIP/AES
WEP Key Length	WEP Key Length	Inactive/128/64
Authentication	Method of the Authentication	none/auto/open/shared/WPA-PSK/WPA2-PSK
Signal Strength	Signal Strength	0 to 100 [%]
TCP/IP Version	TCP/IP Version	IPv4 & IPv6/IPv4
IPv4 IP Address	Selected IP Address (IPv4)	XXX.XXX.XXX.XXX
IPv4 Default Gateway	Default Gateway (IPv4)	XXX.XXX.XXX.XXX
Subnet Mask	Subnet Mask	XXX.XXX.XXX.XXX
IPv6 IP Address *1	Selected IP Address (IPv6)	XXXX:XXXX:XXXX:XXXX XXXX:XXXX:XXXX:XXXX
IPv6 Default Gateway *1	Default Gateway (IPv6)	XXXX:XXXX:XXXX:XXXX XXXX:XXXX:XXXX:XXXX
Subnet Prefix Length*1	Subnet Prefix Length	XXX
IPsec*2	IPsec setting	Active

Security Protocol*2	Method of the Security Protocol	ESP/ESP & AH/AH
WPS PIN CODE	WPS PIN code	XXXXXXXX
Wireless LAN DRX	Discontinuous reception (wireless LAN)	Enable/Disable
Other Settings	Other settings	-
Printer Name	Printer name	Printer name (Up to 15 characters)
WSD	WSD setting	Enable/Disable
WSD Timeout	Timeout	1/5/10/15/20 [min]
LPR Protocol	LPR protocol setting	Enable/Disable
Bonjour	Bonjour setting	Enable/Disable
Bonjour Service Name	Bonjour service name	Bonjour service name (Up to 52 characters)
PictBridge Commun.	PictBridge Communication	Enable/Disable
DNS Server	Getting DNS Server automatically	Auto/Manual
Primary Server	Primary server address	XXX.XXX.XXX.XXX
Secondary Server	Secondary server address	XXX.XXX.XXX.XXX
Proxy Server	Proxy Server setting	Enable/Disable
Proxy Port	Specifying Proxy Port	1 to 65535
Proxy Address	Proxy Address	XXXXXXXXXXXXXXXXXXXXXX
IP Address Filtering	IP Address Filtering	Enable/Disable

("XX" represents alphanumeric characters.)

\*1 Only when IPv6 is activated, the status of the network is printed.

\*2 Only IPv6 and the IPsec setting are activated, the status of the network is printed.

## **About Network Communication**

- ▶ **Changing and Confirming Network Settings**
- ▶ **Screens for Network Connection of IJ Network Tool**
- ▶ **Other Screens of IJ Network Tool**
- ▶ **Appendix for Network Communication**

## **Changing and Confirming Network Settings**

- **IJ Network Tool**
- **Changing the Settings in the Wireless LAN Sheet**
- **Changing the WEP Detailed Settings**
- **Changing the WPA or WPA2 Detailed Settings**
- **Changing the Settings in the Wired LAN Sheet**
- **Changing the Settings in the Admin Password Sheet**
- **Monitoring Wireless Network Status**
- **Initializing the Network Settings of the Machine**
- **Viewing the Modified Settings**

# IJ Network Tool

IJ Network Tool is a utility that enables you to display and modify the machine network settings. It is installed when the machine is set up.

## ▶▶▶ Important

- To use the machine over LAN, make sure you have the equipment necessary for the connection type, such as an access point or a LAN cable.
- Do not start up IJ Network Tool while printing.
- Do not print when IJ Network Tool is running.
- If the firewall function of your security software is turned on, a message may appear warning that Canon software is attempting to access the network. If the warning message appears, set the security software to always allow access.
- IJ Network Tool has been verified to work on Windows XP, however, it does not support Fast User Switching. It is recommended to exit IJ Network Tool when switching users.

## Starting up IJ Network Tool

1. Start up IJ Network Tool as shown below.

- In Windows 8, select **IJ Network Tool** on the **Start** screen to start IJ Network Tool. If **IJ Network Tool** is not displayed on the **Start** screen, select the **Search** charm, then search for "IJ Network Tool".
- In Windows 7, Windows Vista, or Windows XP, click **Start** and select **All programs**, **Canon Utilities**, **IJ Network Tool**, and then **IJ Network Tool**.

## ▶▶▶ Note

- You can also start up IJ Network Tool by clicking  **Network Settings** from **Device Settings & Maintenance** on Quick Menu.



## Changing the Settings in the Wireless LAN Sheet

To change the wireless network settings of the printer, connect the printer and the computer with a USB cable temporarily. If you modify the wireless network settings of the computer over wireless connection without USB connection, your computer may not be able to communicate with the machine after modifying the settings.

### ▶▶▶ Note

- This screen is not available depending on the printer you are using.
- Activate the wireless LAN setting of the printer to change the settings in the **Wireless LAN** sheet.

1. [Start up IJ Network Tool.](#)

2. Select the printer in **Printers**:

When the printer is connected to the computer with a USB cable temporarily, select the printer with "USBnnn" (where "n" is a number) appearing in the **Port Name** column.

3. Select **Configuration...** from the **Settings** menu.

4. Click the **Wireless LAN** tab.

The **Wireless LAN** sheet is displayed.

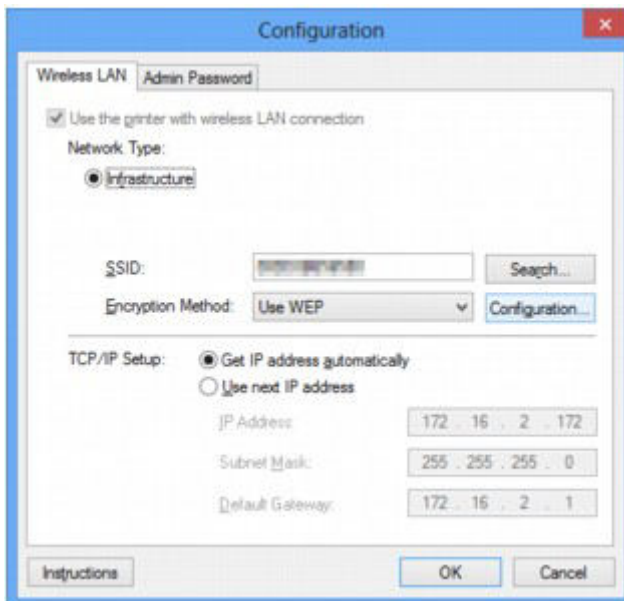

For details on the **Wireless LAN** sheet, see [Wireless LAN Sheet](#).

5. Change the settings or confirm.

#### SSID:

Enter the same value that was set for the target access point.

When the printer is connected with USB, the **Search** screen appears by clicking **Search...**. Set the SSID of the access point by selecting the one of the detected access points.

➡ [Search Screen](#)

## »» Note

- Enter the same SSID that the access point is configured to use. The SSID is case-sensitive.

### Encryption Method:

Select the encryption method used over the wireless LAN.

You can change WEP settings with selecting **Use WEP** and clicking **Configuration....**

➔ [Changing the WEP Detailed Settings](#)

You can change WPA or WPA2 settings with selecting **Use WPA** or **Use WPA2** and clicking **Configuration....**

➔ [Changing the WPA or WPA2 Detailed Settings](#)

## »» Important

- If all encryption types of the access point, printer, or computer do not match, the printer cannot communicate with the computer. If the printer cannot communicate with the computer after the encryption type of the printer was switched, make sure that encryption types for the computer and the access point match that set to the printer.
- If you connect to a network that is not protected with security measures, there is a risk of disclosing data such as your personal information to a third party.

### TCP/IP Setup:

Sets the IP address of the printer to be used over the LAN. Specify a value appropriate for your network environment.

## 6. Click **OK**.

After changing configuration, a screen is displayed asking you for confirmation before the settings are sent to the printer. If you click **Yes**, the settings are sent to the printer and the **Transmitted Settings** screen is displayed.

## »» Note

- Changing the network settings with the USB cable temporarily may switch the default printer. In this case, reset **Set as Default Printer**.

# Changing the WEP Detailed Settings

## ▶▶▶ Note

- This screen is not available depending on the printer you are using.

To change the wireless network settings of the printer, connect the printer and the computer with a USB cable temporarily. If you modify the wireless network settings of the computer over wireless connection without USB connection, your computer may not be able to communicate with the machine after modifying the settings.

1. [Start up IJ Network Tool.](#)

2. Select the printer in **Printers:**.

When the printer is connected to the computer with a USB cable temporarily, select the printer with "USBnnn" (where "n" is a number) appearing in the **Port Name** column.

3. Select **Configuration...** from the **Settings** menu.

4. Click the **Wireless LAN** tab.

5. Select **Use WEP** in **Encryption Method:** and click **Configuration...**

The **WEP Details** screen is displayed.

6. Change the settings or confirm.

When changing the password (WEP key), the same change must be made to the password (WEP key) of the access point.

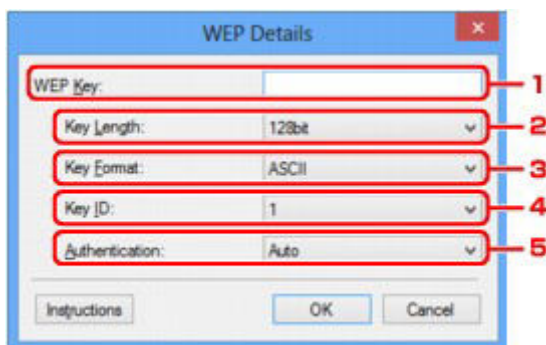

### 1. WEP Key:

Enter the same key as the one set to the access point.

The number of characters and character type that can be entered differ depending on the combination of the key length and key format.

		Key Length	
		64bit	128bit
Key Format	ASCII	5 characters	13 characters
	Hexadecimal (Hex)	10 digits	26 digits

2. **Key Length:**

Select either **64bit** or **128bit**.

3. **Key Format:**

Select either **ASCII** or **Hex**.

4. **Key ID:**

Select the Key ID (index) set to the access point.

5. **Authentication:**

Select the authentication method to authenticate the printer's access to the access point.

Normally, select **Auto**. If you want to specify the method manually, select **Open System** or **Shared Key** according to the setting of the access point.

7. Click **OK**.

 **Important**

- If the printer cannot communicate with the computer after the encryption type of the printer was switched, make sure that encryption types for the computer and the access point match that set to the printer.

 **Note**

- Changing the network settings with the USB cable temporarily may switch the default printer. In this case, reset **Set as Default Printer**.

# Changing the WPA or WPA2 Detailed Settings

## ▶▶▶ Note

- This screen is not available depending on the printer you are using.

To change the wireless network settings of the printer, connect the printer and the computer with a USB cable temporarily. If you modify the wireless network settings of the computer over wireless connection without USB connection, your computer may not be able to communicate with the machine after modifying the settings.

The example screenshots in this section refer to the WPA detailed settings.

1. [Start up IJ Network Tool.](#)

2. Select the printer in **Printers:**.

When the printer is connected to the computer with a USB cable temporarily, select the printer with "USBnnn" (where "n" is a number) appearing in the **Port Name** column.

3. Select **Configuration...** from the **Settings** menu.

4. Click the **Wireless LAN** tab.

5. Select **Use WPA** or **Use WPA2** in **Encryption Method:** and click **Configuration...**

The **WPA Details** screen is displayed (For WPA2, the **WPA2 Details** screen is displayed).

If encryption is not set to the printer, the **Authentication Type Confirmation** screen is displayed. Go to step 7.

6. Click **Change Settings....**

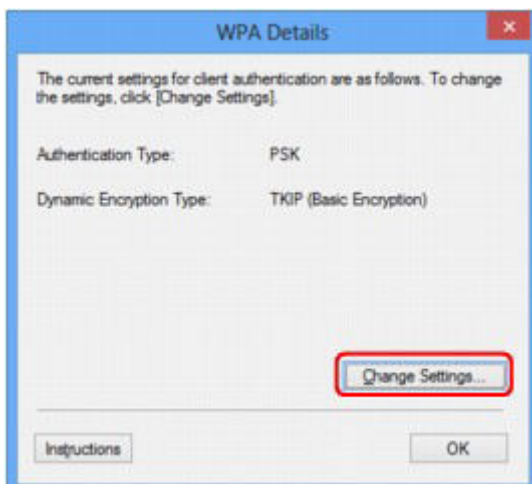

7. Check the client authentication type and click **Next>**.



8. Enter the passphrase, confirm the type of dynamic encryption and click **Next>**.

Enter the passphrase set to the access point. The passphrase should be a string of 8 to 63 alphanumeric characters or a 64-digit hexadecimal value.

If you do not know the access point passphrase, refer to the instruction manual provided with the access point or contact its manufacturer.

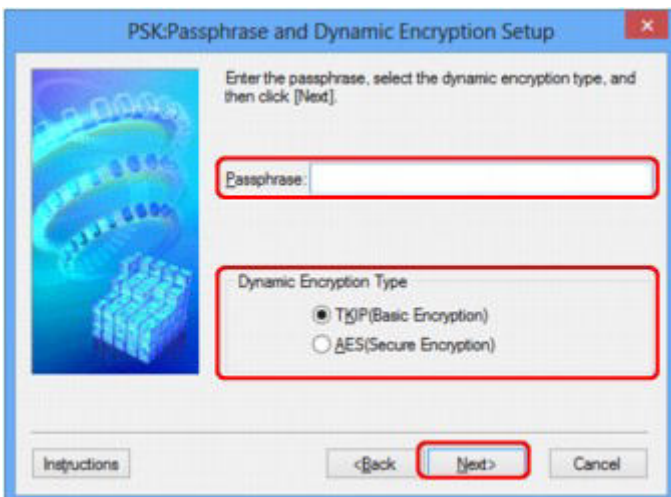

9. Click **Finish**.

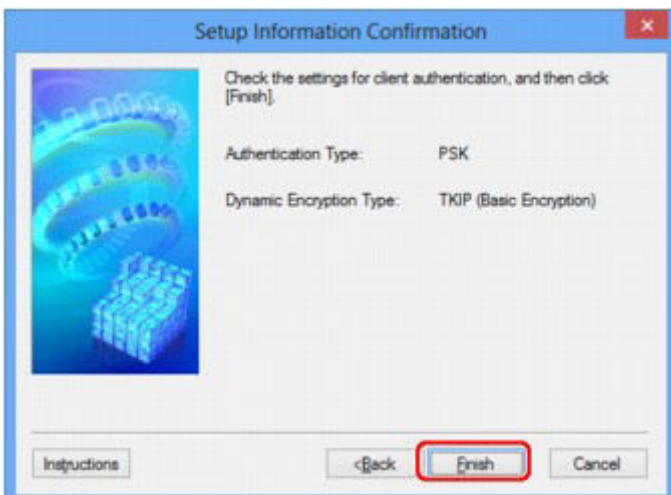

## Important

- If the printer cannot communicate with the computer after the encryption type of the printer was switched, make sure that encryption types for the computer and the access point match that set to the printer.

## Note

- Changing the network settings with the USB cable temporarily may switch the default printer. In this case, reset **Set as Default Printer**.

# Changing the Settings in the Wired LAN Sheet

## ►►► Note

- This screen is not available depending on the printer you are using.
- Activate the wired LAN setting of the printer to change the settings in the **Wired LAN** sheet.

1. [Start up IJ Network Tool.](#)
2. Select the printer in **Printers:**.
3. Select **Configuration...** from the **Settings** menu.
4. Click the **Wired LAN** tab.

The **Wired LAN** sheet is displayed.

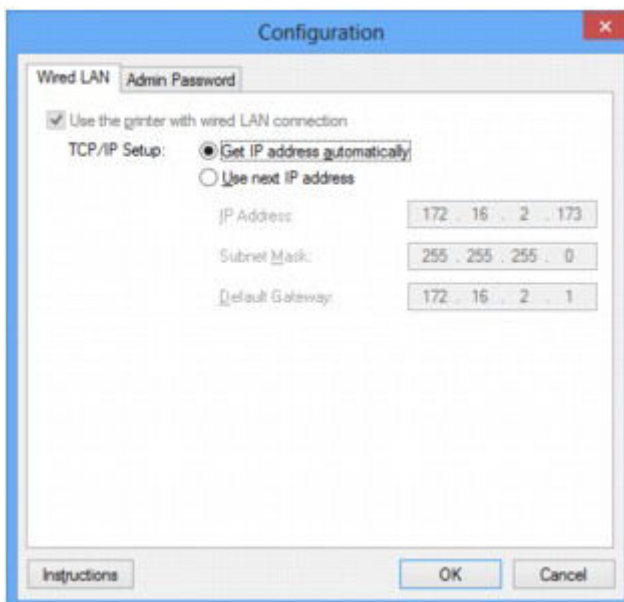

For details on the **Wired LAN** sheet, see [Wired LAN Sheet](#).

5. Change the settings or confirm.

Set the IP address of the printer to be used over the LAN. Specify a value appropriate for your network environment.

6. Click **OK**.

After changing configuration, a screen is displayed asking you for confirmation before the settings are sent to the printer. If you click **Yes**, the settings are sent to the printer and the **Transmitted Settings** screen is displayed.



## Changing the Settings in the Admin Password Sheet

1. [Start up IJ Network Tool.](#)
2. Select the printer in **Printers:**.
3. Select **Configuration...** from the **Settings** menu.
4. Click the **Admin Password** tab.

The **Admin Password** sheet is displayed.

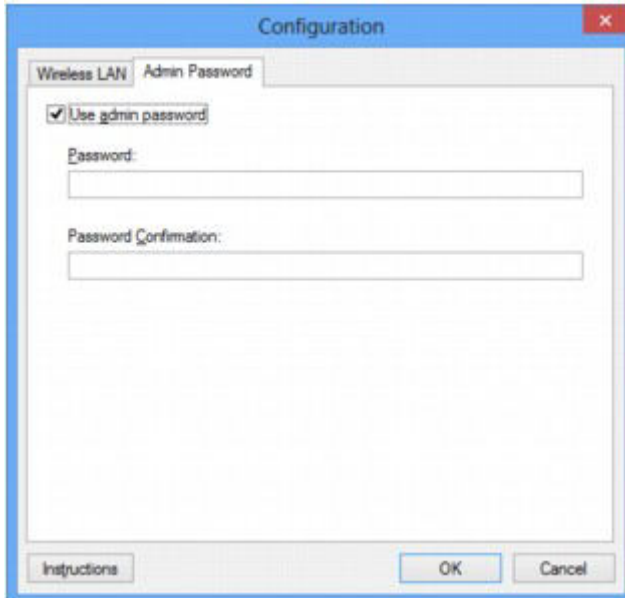

For details on the **Admin Password** sheet, see [Admin Password Sheet](#).

5. Change the settings or confirm.

To use admin password, select the **Use admin password** check box and enter a password.

### ►►► Important

- The password should consist of alphanumeric characters and be no longer than 32 characters. The password is case-sensitive. Do not forget the password you set.

6. Click **OK**.

A screen is displayed asking you for confirmation before the settings are sent to the printer. If you click **Yes**, the settings are sent to the printer and the **Transmitted Settings** screen is displayed.

# Monitoring Wireless Network Status

## ►►► Note

- This screen is not available depending on the printer you are using.
- When using the machine over the wired LAN, you cannot monitor network status.

1. [Start up IJ Network Tool.](#)
2. Select the printer in **Printers:**.
3. Select **Status** from the **View** menu.

The **Status** screen is displayed and you can check the printer status and connection performance.

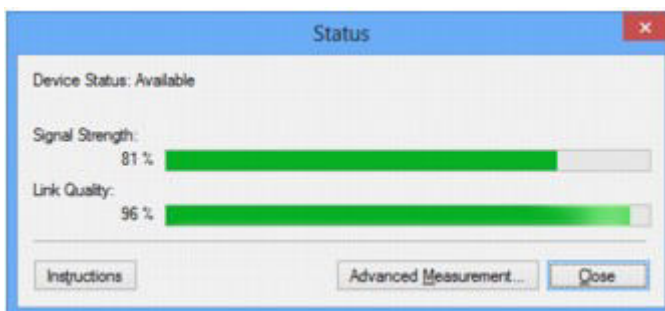

## ►►► Important

- If the indicated value is low, move your printer closer to the wireless network device.

4. If you measure the connection performance in detail, click **Advanced Measurement...**  
The **Connection Performance Measurement** screen is displayed.
5. Click **Next>**.

The measurement starts and the status displays. Measurement takes a few minutes.

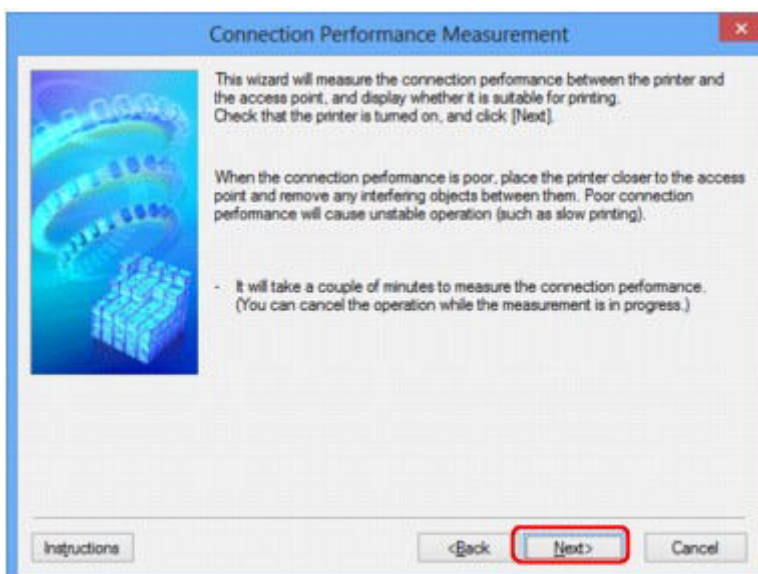

## 6. Check the status.

When the measurement is complete, the status is displayed.

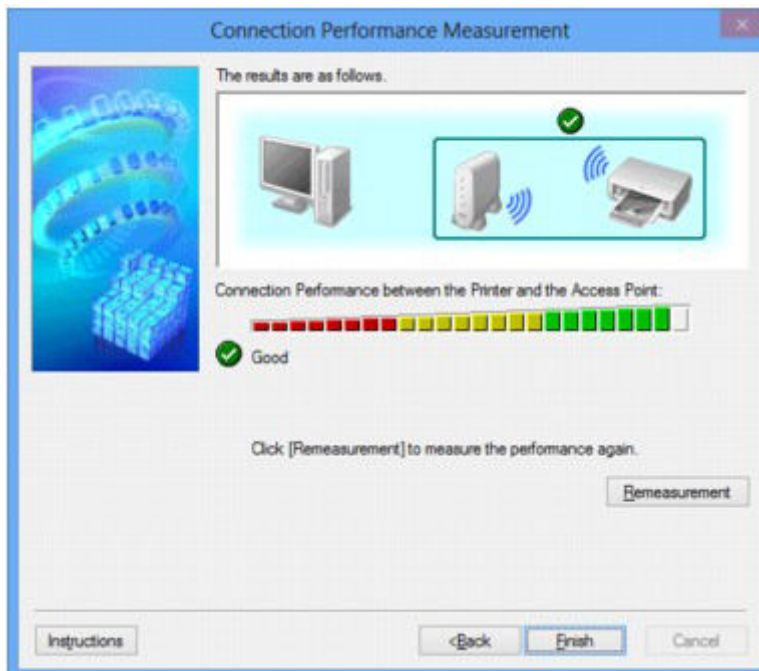

When  is displayed in **Connection Performance between the Printer and the Access Point:**, the printer can communicate with the access point. Otherwise, refer to displayed comments and the following to improve the status of communication link, and click **Remeasurement**.

- Check that the printer and the access point are located within the wireless connectivity range with no obstacles between them.
- Check if the distance between the printer and the access point is not too far.  
If they are too far, move them closer together (within 164 ft./50 m).
- Check that there is no barrier or obstacle between the printer and the access point.  
In general, connection performance decreases for communications through walls or between different floors. Adjust the locations to avoid such situations.
- Check that there are no sources of radio interference near the printer and the access point.  
The wireless connection may use the same frequency band as microwave ovens and other sources of radio interference. Try to keep the printer and the access point away from such sources.
- Check if the radio channel of the access point is close to that of other access points nearby.  
If the radio channel of the access point is close to that of other access points nearby, the connection performance may become unstable. Be sure to use a radio channel that does not interfere with other access points.
- Check that the printer and the access point face each other.  
Connection performance may depend on the orientations of the wireless devices. Replace the access point and the printer in another direction to achieve the best performance.
- Check whether other computers are not accessing the printer.

If  appears in the result of the measurement, check whether other computers are not accessing the printer.

If  still appears even if you have tried the above, finish the measurement, then restart the IJ Network Tool to start over the measurement.

7. Click **Finish**.

 **Note**

- If any messages appear on **Overall Network Performance:**, move the machine and access point as instructed to improve the performance.

# Initializing the Network Settings of the Machine

## ▶▶▶ Important

- Note that initialization erases all network settings on the machine, printing or scanning operation from a computer over network may become impossible. To use the machine over network, perform setup with the Setup CD-ROM or perform setup according to the instructions on our website.

1. [Start up IJ Network Tool.](#)
2. Select the printer in **Printers:**.
3. Select **Maintenance...** from the **Settings** menu.  
The **Maintenance** screen is displayed.
4. Click **Initialize**.

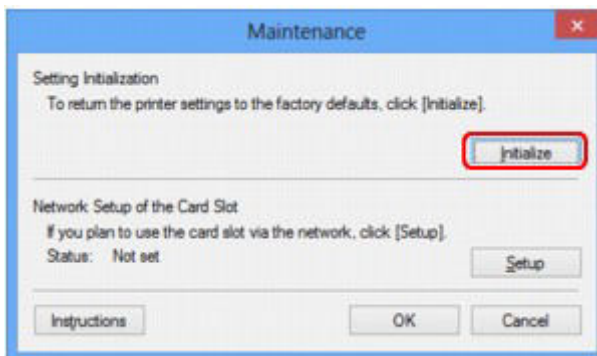

5. When the confirmation screen is displayed, click **Yes**.

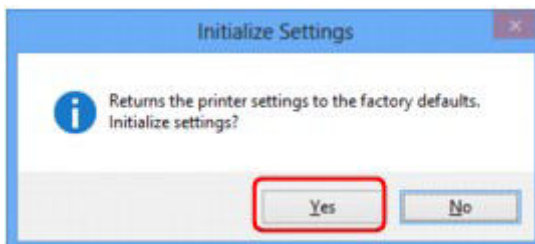

The network settings of the printer is initialized.

Do not turn off the printer during initialization.

Click **OK** when initialization is complete.

Performing initialization when connected over wireless LAN will break the connection, so perform setup with the Setup CD-ROM or perform setup according to the instructions on our website.

## ▶▶▶ Note

- You can change the network settings of the printer using IJ Network Tool with USB connection after initializing the LAN settings. To change the network settings using Canon IJ Network Tool, activate wireless LAN in advance.

## Viewing the Modified Settings

The **Confirmation** screen is displayed when you modified the printer settings on the **Configuration** screen. When you click **Yes** on the **Confirmation** screen, the following screen is displayed for confirming the modified settings.

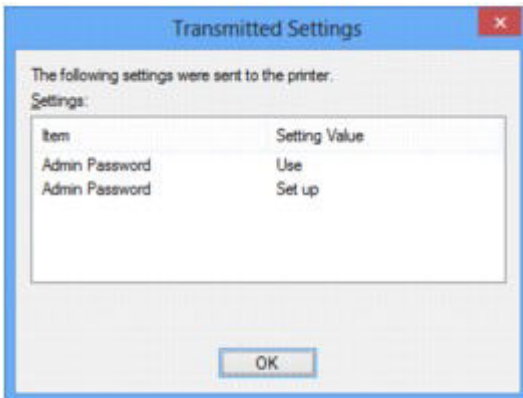

## **Screens for Network Connection of IJ Network Tool**

- ▶ **Canon IJ Network Tool Screen**
- ▶ **Configuration Screen**
- ▶ **Wireless LAN Sheet**
- ▶ **Search Screen**
- ▶ **WEP Details Screen**
- ▶ **WPA Details Screen**
- ▶ **WPA2 Details Screen**
- ▶ **Authentication Type Confirmation Screen**
- ▶ **PSK: Passphrase and Dynamic Encryption Setup Screen**
- ▶ **Setup Information Confirmation Screen**
- ▶ **Wired LAN Sheet**
- ▶ **Admin Password Sheet**
- ▶ **Network Information Screen**
- ▶ **Access Control Sheet**
- ▶ **Edit Accessible MAC Address Screen/Add Accessible MAC Address Screen**
- ▶ **Edit Accessible IP Address Screen/Add Accessible IP Address Screen**

# Canon IJ Network Tool Screen

This section describes the items and menus displayed on the **Canon IJ Network Tool** screen.

➔ [Items on the Canon IJ Network Tool Screen](#)

➔ [Canon IJ Network Tool Menus](#)

## Items on the Canon IJ Network Tool Screen

The following item is displayed on the **Canon IJ Network Tool** screen.

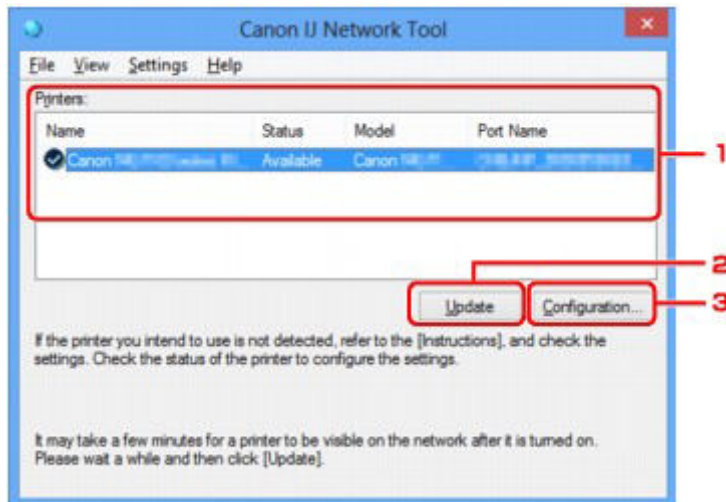

### 1. Printers:

The printer name, status, printer model name, and port name are displayed.

A check mark next to the printer in the **Name** list indicates it is set as the default printer.

Configuration changes are applied to the selected printer.

### 2. Update

Performs printer detection again. Click this button if the target printer is not displayed.

#### ➔➔➔ Important

- To change the printer's network settings using IJ Network Tool, it must be connected via a LAN.
- If **No Driver** is displayed for the name, associate the port with the printer.
  - ➔ [When the Printer Driver Is Not Associated with a Port](#)
- If **Not Found** is displayed for the status, check the followings:
  - The access point is turned on.
  - When using wired LAN, the LAN cable is connected properly.
- If the printer on a network is not detected, make sure that the printer is turned on, then click **Update**. It may take several minutes to detect printers. If the printer is not yet detected, connect the machine and the computer with a USB cable, then click **Update**.
- If the printer is being used from another computer, a screen is displayed informing you of this condition.



## ►►► Note

- This item has the same function as **Refresh** in the **View** menu.

### 3. Configuration...

Click to configure settings of the selected printer.

➔ [Configuration Screen](#)

## ►►► Note

- You cannot configure a printer that has the status **Not Found**.
- This item has the same function as **Configuration...** in the **Settings** menu.

## Canon IJ Network Tool Menus

The following menu is displayed from the **Canon IJ Network Tool** screen.

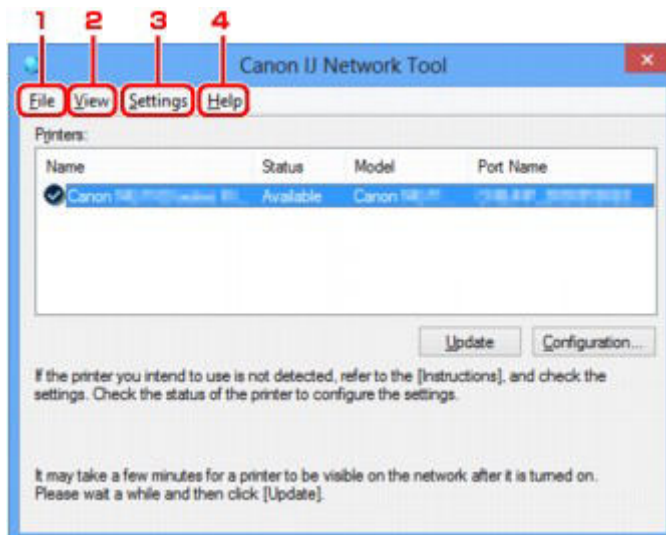

### 1. File menu

#### Exit

Exits IJ Network Tool.

### 2. View menu

#### Status

Displays the **Status** screen to confirm the printer connection status and wireless communication status.

➔ [Status Screen](#)

#### Refresh

Updates and displays the contents of **Printers:** on the **Canon IJ Network Tool** screen to the latest information.

## ►►► Important

- To change the printer's network settings using IJ Network Tool, it must be connected via a LAN.
- If **No Driver** is displayed for the name, associate the port with the printer.

➔ [When the Printer Driver Is Not Associated with a Port](#)

- If **Not Found** is displayed for the status, check the followings:
  - The access point is turned on.
  - When using wired LAN, the LAN cable is connected properly.
- If the printer on a network is not detected, make sure that the printer is turned on, then select **Refresh**. It may take several minutes to detect printers. If the printer is not yet detected, connect the machine and the computer with a USB cable, then select **Refresh**.
- If the printer is being used from another computer, a screen is displayed informing you of this condition.

➔➔➔ **Note**

- This item has the same function as **Update** in the **Canon IJ Network Tool** screen.

**Network Information**

Displays the **Network Information** screen to confirm the network settings of the printer and the computer.

➔ [Network Information Screen](#)

**Display Warning Automatically**

Enables or disables automatic display of the instruction screen.

When this menu is selected, the instruction screen is displayed if one or more ports are unavailable for printing.

3. **Settings** menu

**Configuration...**

Displays the **Configuration** screen to configure settings of the selected printer.

➔ [Configuration Screen](#)

➔➔➔ **Note**

- This item has the same function as **Configuration...** in the **Canon IJ Network Tool** screen.

**Associate Port...**

Displays the **Associate Port** screen and you can associate a port with the printer.

➔ [Associate Port Screen](#)

This menu is available when **No Driver** is displayed for the selected printer. Associating a port with the printer enables you to use it.

**Maintenance...**

Displays the **Maintenance** screen to revert the network settings of the printer to factory default and to mount the card slot as the network drive.

➔ [Maintenance Screen](#)

4. **Help** menu

**Instructions**

Displays this guide.

**About**

Displays the version of IJ Network Tool.

## Configuration Screen

You can change the configuration of the printer selected on the **Canon IJ Network Tool** screen.

Click the tab to select the sheet to change the settings.

The following screen is the example to change the setting on the **Wireless LAN** sheet.

### ▶▶▶ Note

- This screen is not available depending on the printer you are using.

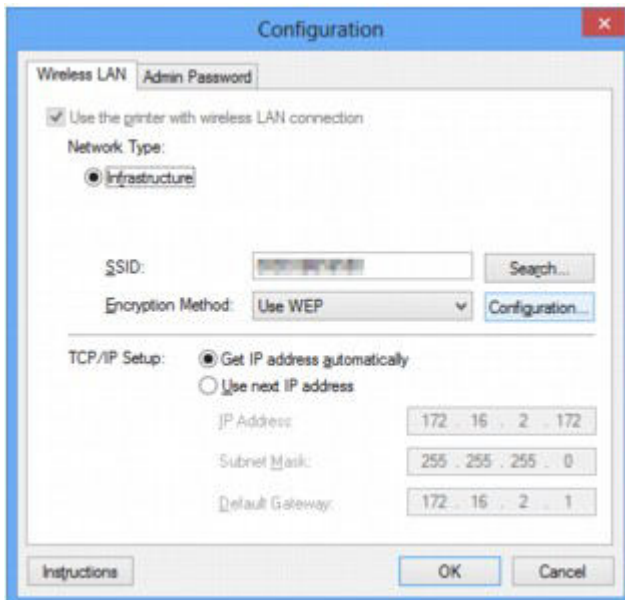

For details on each sheet, see the following.

➔ [Wireless LAN Sheet](#)

➔ [Wired LAN Sheet](#)

➔ [Admin Password Sheet](#)

# Wireless LAN Sheet

## ▶▶▶ Note

- This screen is not available depending on the printer you are using.

Allows you to set the printer with wireless LAN connection.

To display the **Wireless LAN** sheet, click the **Wireless LAN** tab on the **Configuration** screen.

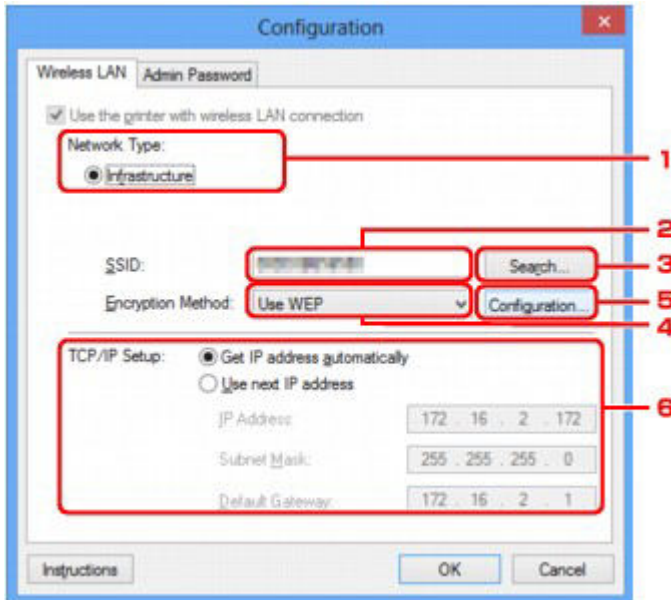

### 1. Network Type:

#### Infrastructure

Connects the printer to the wireless LAN with an access point.

### 2. SSID:

The SSID of the wireless LAN is displayed.

As the initial settings, the unique value is displayed.

## ▶▶▶ Note

- Enter the same SSID that the access point is configured to use. The SSID is case-sensitive.

### 3. Search...

The **Search** screen is displayed to select an access point to connect to.

➔ [Search Screen](#)

## ▶▶▶ Note

- When IJ Network Tool runs over a LAN, the button is grayed out and cannot be selected. Connect the printer and the computer with a USB cable temporarily to change the settings.

### 4. Encryption Method:

Select the encryption method used over the wireless LAN.

**Do not use**

Select to disable encryption.

**Use WEP**

Transmission is encrypted using a WEP key you specified.

If a WEP key has not been set, the **WEP Details** screen is displayed automatically. To change WEP settings set before, click **Configuration...** to display the screen.

➡ [Changing the WEP Detailed Settings](#)

**Use WPA/Use WPA2**

Transmission is encrypted using a WPA or WPA2 key you specified.

The security has been strengthened more than WEP.

If a WPA or WPA2 key has not been set, the **Authentication Type Confirmation** screen is displayed automatically. To change WPA or WPA2 settings set before, click **Configuration...** to display the **WPA Details** screen or **WPA2 Details** screen.

➡ [Changing the WPA or WPA2 Detailed Settings](#)

**5. Configuration...**

The detailed settings screen is displayed. The WEP, the WPA, or the WPA2 key selected in **Encryption Method**: can be confirmed and changed.

**For details on WEP setting:**

➡ [Changing the WEP Detailed Settings](#)

**For details on WPA or WPA2 setting:**

➡ [Changing the WPA or WPA2 Detailed Settings](#)

**6. TCP/IP Setup:**

Sets the IP address of the printer to be used over the LAN. Specify a value appropriate for your network environment.

**Get IP address automatically**

Select this option to use an IP address automatically assigned by a DHCP server. DHCP server functionality must be enabled on your wireless LAN router or access point.

**Use next IP address**

If no DHCP server functionality is available in your setup where you use the printer or you want to use a particular IP address, select this option to use a fixed IP address.

# Search Screen

## ▶▶▶ Note

- This screen is not available depending on the printer you are using.

The access points detected are listed.

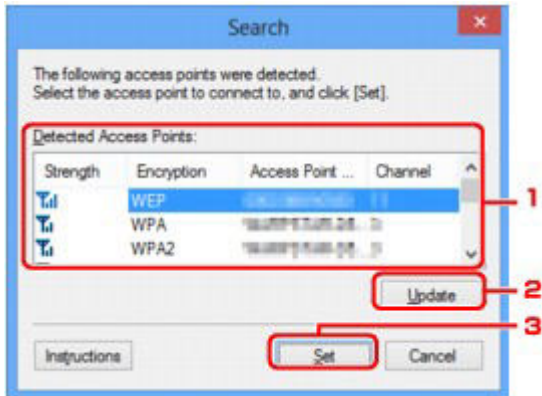

## 1. Detected Access Points:

The signal strength from the access point, encryption type, name of access point, and the radio channel can be confirmed.

## ▶▶▶ Important

- If you connect to a network that is not protected with security measures, there is a risk of disclosing data such as your personal information to a third party.

## ▶▶▶ Note

- Signal strength is displayed as follows.

Full : Good

Fair : Fair

Poor : Poor

- Type of encryption is displayed as follows.

Blank: No encryption

**WEP**: WEP is set

**WPA**: WPA is set

**WPA2**: WPA2 is set

## 2. Update

Click to update the list of access points when your target access point is not detected.

If the target access point is set to the stealth mode, click **Cancel** to return to the previous screen and enter the access point's SSID in **SSID**: on the **Wireless LAN** sheet.

➔ [Wireless LAN Sheet](#)

### »» Note

- When detecting your target access point, make sure that the access point is turned on.

### 3. Set

Click to set the access point's SSID in **SSID:** on the **Wireless LAN** sheet.

### »» Note

- The **WEP Details** screen, the **WPA Details** screen, or the **WPA2 Details** screen appears if the selected access point is encrypted. In this case, configure the details to use the same encryption settings set to the access point.
- Access points that cannot be used by this machine (including those configured to use different encryption methods) are displayed grayed out and cannot be configured.

# WEP Details Screen

## ▶▶▶ Note

- This screen is not available depending on the printer you are using.

Specify the printer WEP settings.

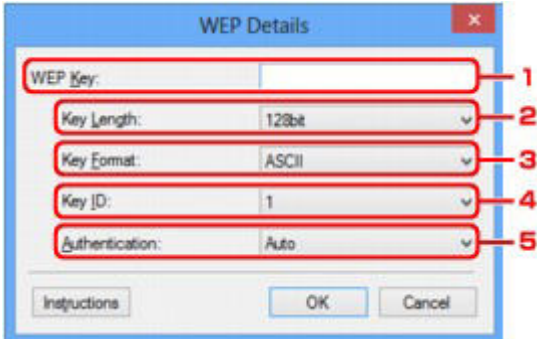

## ▶▶▶ Note

- When changing the password (WEP key) of the printer, the same change must be made to the password (WEP key) of the access point.

### 1. WEP Key:

Enter the same key as the one set to the access point.

The number of characters and character type that can be entered differ depending on the combination of the key length and key format.

		Key Length	
		64bit	128bit
Key Format	ASCII	5 characters	13 characters
	Hexadecimal (Hex)	10 digits	26 digits

### 2. Key Length:

Select either **64bit** or **128bit**.

### 3. Key Format:

Select either **ASCII** or **Hex**.

### 4. Key ID:

Select the Key ID (index) set to the access point.

### 5. Authentication:

Select the authentication method to authenticate the printer's access to the access point.

Select **Auto** or **Open System** or **Shared Key**.



# WPA Details Screen

## ▶▶▶ Note

- This screen is not available depending on the printer you are using.

Specify the printer WPA settings.

The value displayed on the screen differs depending on the present settings.

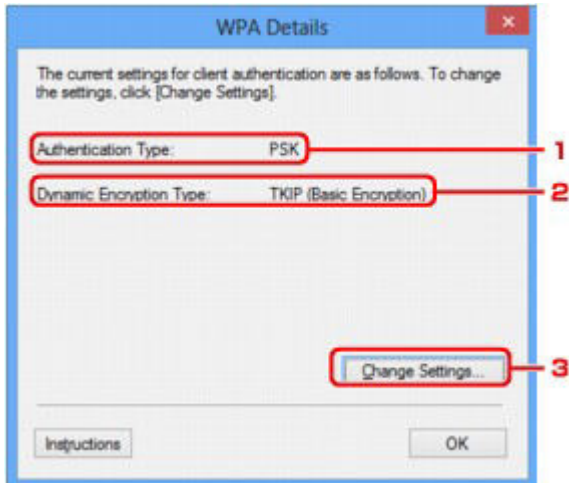

### 1. Authentication Type:

Displays the type of authentication used for client authentication. This machine supports the PSK authentication method.

### 2. Dynamic Encryption Type:

Displays the dynamic encryption method.

### 3. Change Settings...

Displays the **Authentication Type Confirmation** screen.

➔ [Authentication Type Confirmation Screen](#)

# WPA2 Details Screen

## ▶▶▶ Note

- This screen is not available depending on the printer you are using.

Specify the printer WPA2 settings.

The value displayed on the screen differs depending on the present settings.

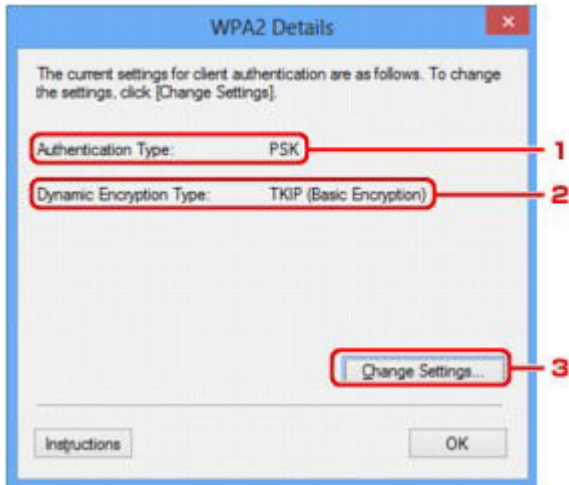

### 1. Authentication Type:

Displays the type of authentication used for client authentication. This machine supports the PSK authentication method.

### 2. Dynamic Encryption Type:

Displays the dynamic encryption method.

### 3. Change Settings...

Displays the **Authentication Type Confirmation** screen.

➔ [Authentication Type Confirmation Screen](#)

# Authentication Type Confirmation Screen

## ►►► Note

- This screen is not available depending on the printer you are using.

Type of authentication used for client authentication is displayed.

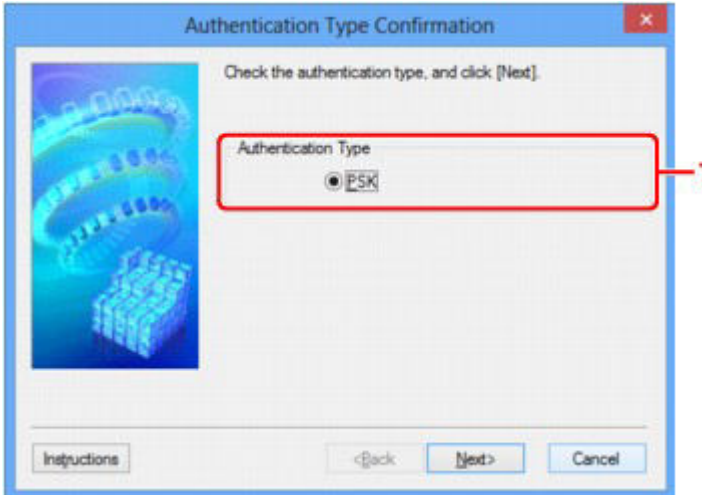

### 1. Authentication Type

Type of authentication used for client authentication is displayed.

#### PSK

This machine supports the **PSK** authentication method.

This authentication type **PSK** uses a passphrase.

# PSK: Passphrase and Dynamic Encryption Setup Screen

## ►►► Note

- This screen is not available depending on the printer you are using.

Enter the passphrase and select the dynamic encryption method.

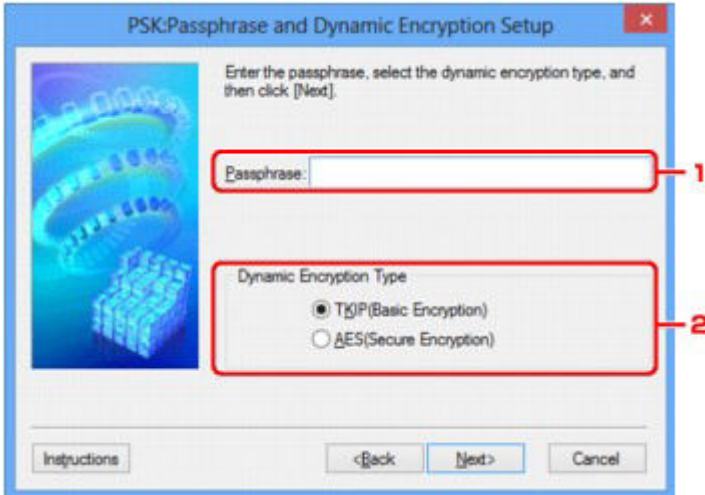

### 1. Passphrase:

Enter the passphrase set to the access point. The passphrase should be a string of 8 to 63 alphanumeric characters or a 64-digit hexadecimal value.

If you do not know the access point passphrase, refer to the instruction manual provided with the access point or contact its manufacturer.

### 2. Dynamic Encryption Type

Select the dynamic encryption method from either **TKIP (Basic Encryption)**, or **AES (Secure Encryption)** according to the setting of the access point.

## Setup Information Confirmation Screen

### ►►► Note

- This screen is not available depending on the printer you are using.

Displays the settings used for client authentication.

Confirm the settings and click **Finish**.

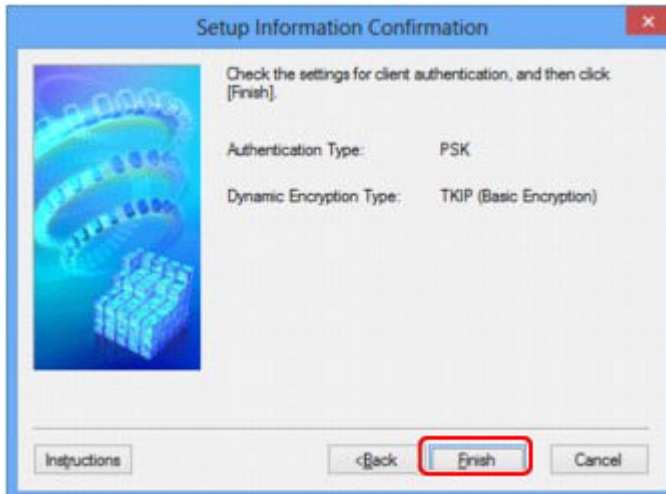

# Wired LAN Sheet

## ▶▶▶ Note

- This screen is not available depending on the printer you are using.

Allows you to set the printer with wired LAN connection.

To display the **Wired LAN** sheet, click the **Wired LAN** tab on the **Configuration** screen.

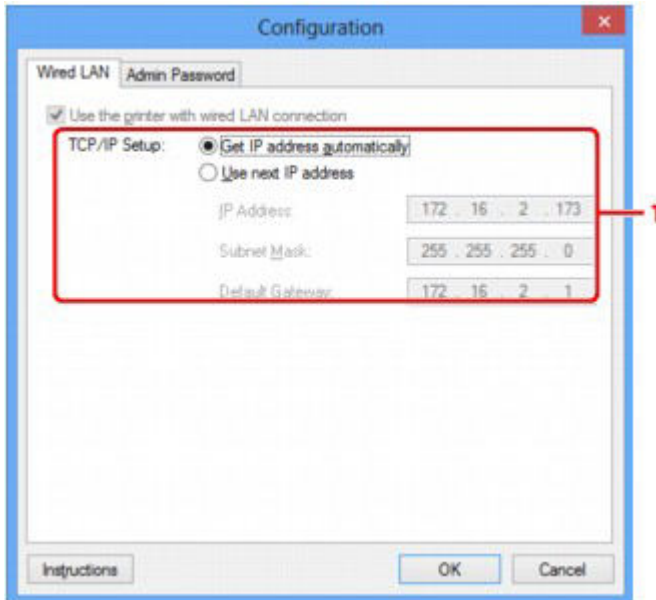

### 1. TCP/IP Setup:

Sets the IP address of the printer to be used over the LAN. Specify a value appropriate for your network environment.

#### **Get IP address automatically**

Select this option to use an IP address automatically assigned by a DHCP server. DHCP server functionality must be enabled on your router.

#### **Use next IP address**

If no DHCP server functionality is available in your setup where you use the printer or you want to use a particular IP address, select this option to use a fixed IP address.

# Admin Password Sheet

Set a password for the printer to allow specific people to perform setup and configurations operation.

To display the **Admin Password** sheet, click the **Admin Password** tab on the **Configuration** screen.

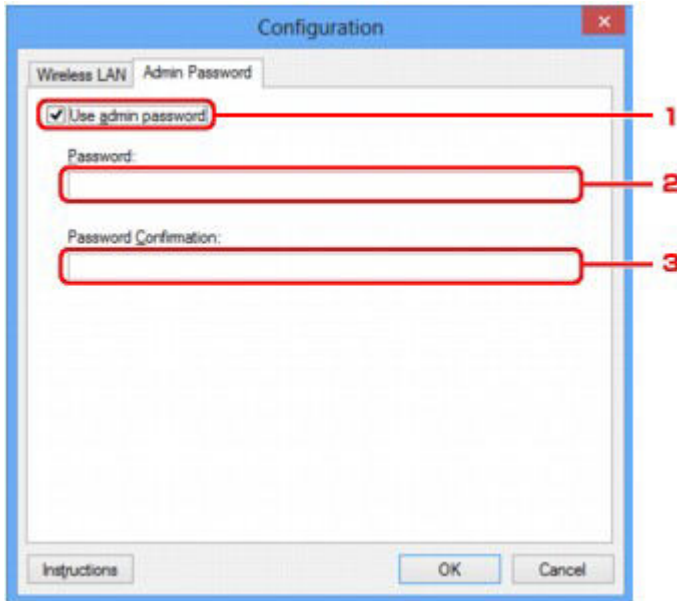

## 1. Use admin password

Set a password for the administrator with privileges to set up and change detailed options. To use this feature, select this check box and enter a password.

## 2. Password:

Enter the password to set.

## 3. Password Confirmation:

Enter the password again for confirmation.

# Network Information Screen

Display the network information that is set for the printers and the computers.

To display the **Network Information** screen, select **Network Information** from the **View** menu.

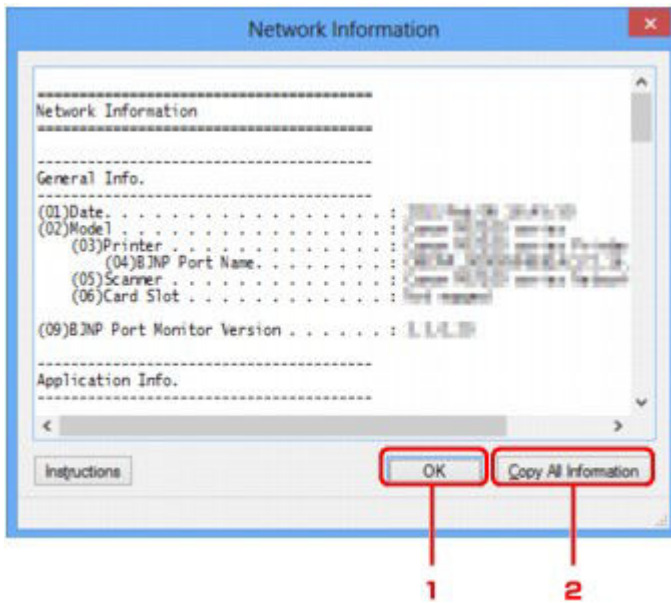

## 1. OK

Returns to the **Canon IJ Network Tool** screen.

## 2. Copy All Information

All network information displayed is copy to the clipboard.



# Access Control Sheet

## ▶▶▶ Note

- This screen is not available depending on the printer you are using.

You can register the MAC addresses or the IP addresses of computers or network devices to allow access. To display the **Access Control** sheet, click the **Access Control** tab on the **Configuration** screen.

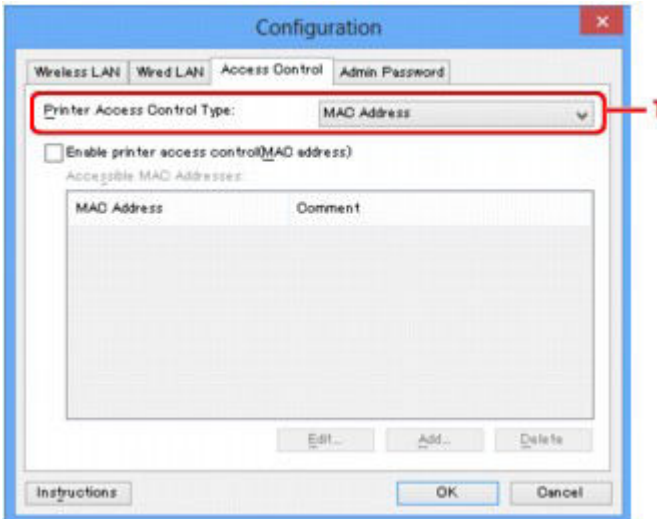

### 1. Printer Access Control Type:

Select the type of access control with which to limit access of computers or network devices to the printer over a network.

The setting items may differ depending on the choice of access control methods.

➡ [When Selecting MAC address](#)

➡ [When Selecting IP address](#)

### When Selecting MAC address

The accessible computers or network devices are specified by their MAC addresses. Computers or network devices whose MAC addresses appear on the list are allowed access.

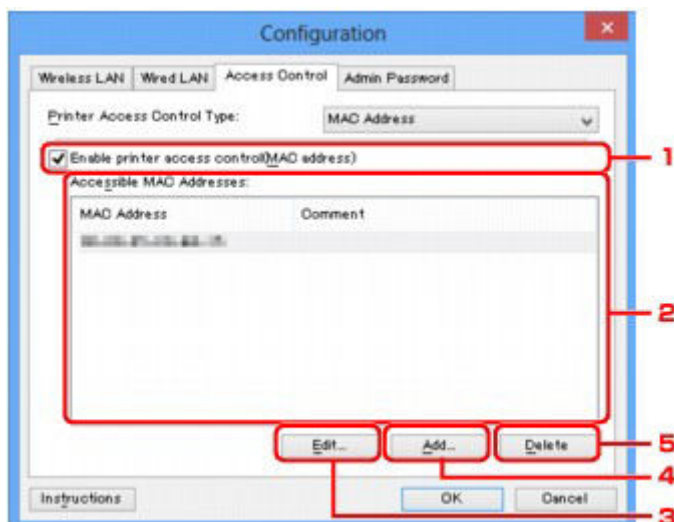



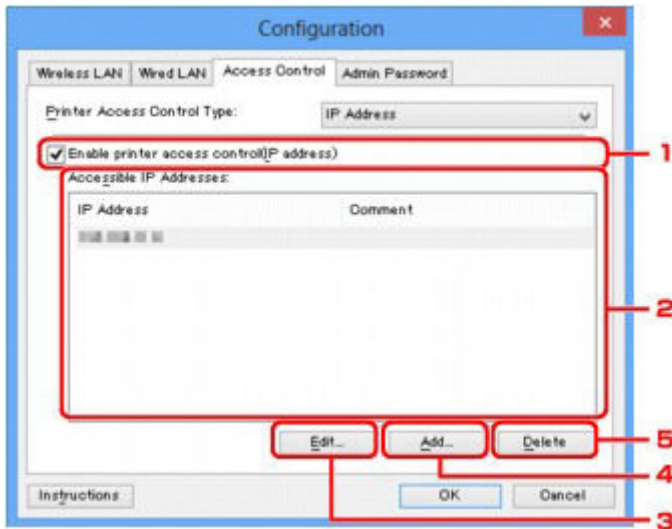

### 1. Enable printer access control(IP address)

Select to enable access control to the printer by IP address.

#### ➤➤➤ Note

- The two types of access control (i.e., by MAC address and by IP address) can be enabled at the same time.
- An access control type is enabled as long as the **Enable printer access control** check box is selected, regardless of the type currently displayed by selecting in **Printer Access Control Type**:
- When both access control types are enabled at the same time, a computer or a network device whose address is registered to either list will be allowed access to the printer.

### 2. Accessible IP Addresses:

Shows the registered IP addresses and any comments.

### 3. Edit...

The **Edit Accessible IP Address** screen is displayed to edit the settings selected in **Accessible IP Addresses**:

➔ [Edit Accessible IP Address Screen/Add Accessible IP Address Screen](#)

### 4. Add...

The **Add Accessible IP Address** screen is displayed to register the IP address of a computer or a network device from which to access the printer over the network.

#### ➤➤➤ Important

- Add the IP address of all computers or network devices within the network from which to access the printer. The printer cannot be accessed from a computer or a network device that is not on the list.
- Up to 16 IP addresses can be registered. IP addresses specified by Range Specification are counted as one address. Use Range Specification when you intend to register 17 or more IP addresses.

## 5. Delete

Deletes the selected IP address from the list.

# Edit Accessible MAC Address Screen/Add Accessible MAC Address Screen

## ▶▶▶ Note

- This screen is not available depending on the printer you are using.

The example screenshots in this section refer to the **Add Accessible MAC Address** Screen.



### 1. **MAC Address:**

Enter the MAC address of a computer or a network device to allow access.

### 2. **Comment:**

Optionally enter any information to identify the device, such as the name of the computer.

## ▶▶▶ Important

- Comments will be displayed only on the computer used to enter them.

# Edit Accessible IP Address Screen/Add Accessible IP Address Screen

## »» Note

- This screen is not available depending on the printer you are using.

The example screenshots in this section refer to the **Add Accessible IP Address** Screen.

### 1. Specification Method:

Select either **Single Address Specification** or **Range Specification** to add the IP address(es).

#### Single Address Specification

Specify each IP address separately.

#### Range Specification

Specify a range of successive IP addresses.

### 2. IP Address:

Enter the IP address of a computer or a network device to allow access when you selected **Single Address Specification** in **Specification Method**:

An IP address is expressed as four values ranging from 0 to 255.

#### Start IP Address:

Enter the first IP address in the range of addresses of the computers or network devices to allow access when you selected **Range Specification** in **Specification Method**:

An IP address is expressed as four values ranging from 0 to 255.

#### End IP Address:

Enter the last IP address in the range of addresses of the computers or network devices to allow access when you selected **Range Specification** in **Specification Method**:

An IP address is expressed as four values ranging from 0 to 255.

## »» Note

- The **Start IP Address**: must be a smaller value than the **End IP Address**:

### 3. Comment:

Optionally enter any information to identify the device, such as the name of the computer.

## »» Important

- Comments will be displayed only on the computer used to enter them.

## **Other Screens of IJ Network Tool**

- ▶ **Canon IJ Network Tool Screen**
- ▶ **Status Screen**
- ▶ **Connection Performance Measurement Screen**
- ▶ **Maintenance Screen**
- ▶ **Network Setup of the Card Slot Screen**
- ▶ **Associate Port Screen**
- ▶ **Network Information Screen**

# Canon IJ Network Tool Screen

This section describes the items and menus displayed on the **Canon IJ Network Tool** screen.

➔ [Items on the Canon IJ Network Tool Screen](#)

➔ [Canon IJ Network Tool Menus](#)

## Items on the Canon IJ Network Tool Screen

The following item is displayed on the **Canon IJ Network Tool** screen.

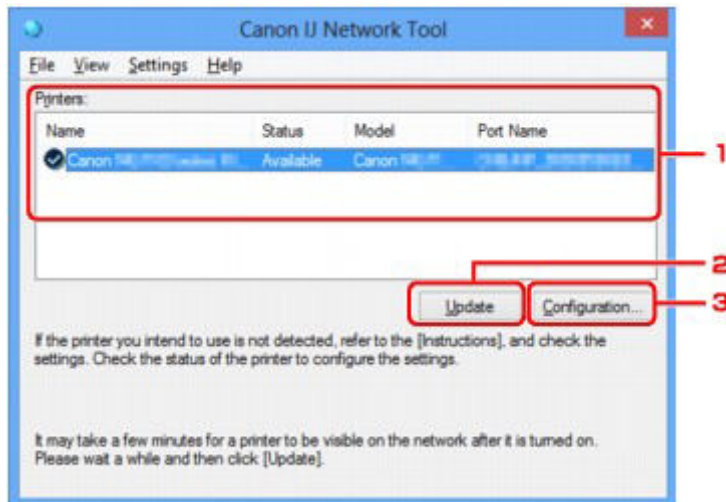

### 1. Printers:

The printer name, status, printer model name, and port name are displayed.

A check mark next to the printer in the **Name** list indicates it is set as the default printer.

Configuration changes are applied to the selected printer.

### 2. Update

Performs printer detection again. Click this button if the target printer is not displayed.

#### ➔➔➔ Important

- To change the printer's network settings using IJ Network Tool, it must be connected via a LAN.
- If **No Driver** is displayed for the name, associate the port with the printer.
  - ➔ [When the Printer Driver Is Not Associated with a Port](#)
- If **Not Found** is displayed for the status, check the followings:
  - The access point is turned on.
  - When using wired LAN, the LAN cable is connected properly.
- If the printer on a network is not detected, make sure that the printer is turned on, then click **Update**. It may take several minutes to detect printers. If the printer is not yet detected, connect the machine and the computer with a USB cable, then click **Update**.
- If the printer is being used from another computer, a screen is displayed informing you of this condition.



## ►►► Note

- This item has the same function as **Refresh** in the **View** menu.

### 3. Configuration...

Click to configure settings of the selected printer.

➔ [Configuration Screen](#)

## ►►► Note

- You cannot configure a printer that has the status **Not Found**.
- This item has the same function as **Configuration...** in the **Settings** menu.

## Canon IJ Network Tool Menus

The following menu is displayed from the **Canon IJ Network Tool** screen.

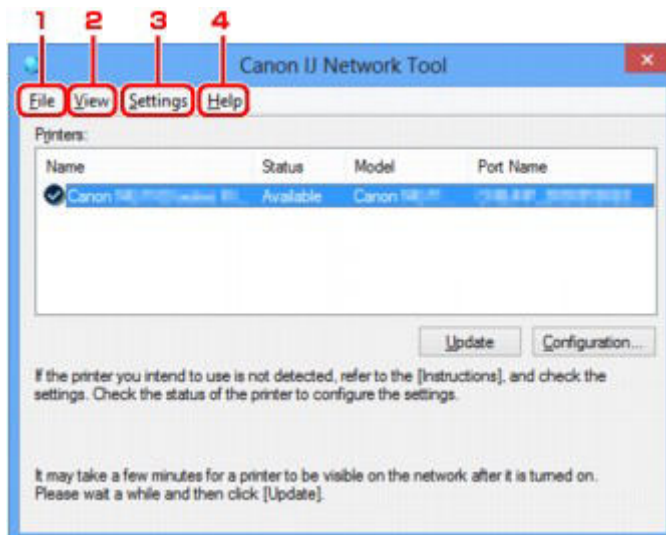

### 1. File menu

#### Exit

Exits IJ Network Tool.

### 2. View menu

#### Status

Displays the **Status** screen to confirm the printer connection status and wireless communication status.

➔ [Status Screen](#)

#### Refresh

Updates and displays the contents of **Printers:** on the **Canon IJ Network Tool** screen to the latest information.

## ►►► Important

- To change the printer's network settings using IJ Network Tool, it must be connected via a LAN.
- If **No Driver** is displayed for the name, associate the port with the printer.

➔ [When the Printer Driver Is Not Associated with a Port](#)

- If **Not Found** is displayed for the status, check the followings:
  - The access point is turned on.
  - When using wired LAN, the LAN cable is connected properly.
- If the printer on a network is not detected, make sure that the printer is turned on, then select **Refresh**. It may take several minutes to detect printers. If the printer is not yet detected, connect the machine and the computer with a USB cable, then select **Refresh**.
- If the printer is being used from another computer, a screen is displayed informing you of this condition.

➔➔➔ **Note**

- This item has the same function as **Update** in the **Canon IJ Network Tool** screen.

**Network Information**

Displays the **Network Information** screen to confirm the network settings of the printer and the computer.

➔ [Network Information Screen](#)

**Display Warning Automatically**

Enables or disables automatic display of the instruction screen.

When this menu is selected, the instruction screen is displayed if one or more ports are unavailable for printing.

3. **Settings** menu

**Configuration...**

Displays the **Configuration** screen to configure settings of the selected printer.

➔ [Configuration Screen](#)

➔➔➔ **Note**

- This item has the same function as **Configuration...** in the **Canon IJ Network Tool** screen.

**Associate Port...**

Displays the **Associate Port** screen and you can associate a port with the printer.

➔ [Associate Port Screen](#)

This menu is available when **No Driver** is displayed for the selected printer. Associating a port with the printer enables you to use it.

**Maintenance...**

Displays the **Maintenance** screen to revert the network settings of the printer to factory default and to mount the card slot as the network drive.

➔ [Maintenance Screen](#)

4. **Help** menu

**Instructions**

Displays this guide.

**About**

Displays the version of IJ Network Tool.

# Status Screen

You can check the printer status and connection performance.

To display the **Status** screen, select **Status** from the **View** menu.

## ▶▶▶ Note

- This screen is not available depending on the printer you are using.
- When using wired LAN, **Signal Strength:**, **Link Quality:** and **Advanced Measurement...** are not available.

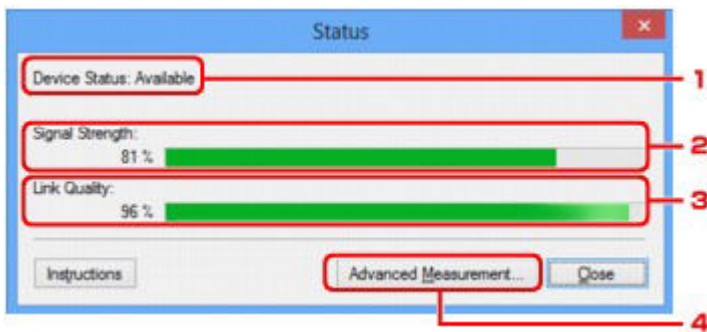

### 1. Device Status:

The device status is displayed as **Available** or **Unavailable**.

### 2. Signal Strength:

Indicates the strength of the signal received by the printer, ranging from 0% to 100%.

### 3. Link Quality:

Indicates the signal quality excluding the noise while communicating, ranging from 0% to 100%.

### 4. Advanced Measurement...

To examine the connection performance between the printer and the access point or between the printer and the computer.

When you click, the **Connection Performance Measurement** is displayed.

➔ [Connection Performance Measurement Screen](#)

# Connection Performance Measurement Screen

## ▶▶▶ Note

- This screen is not available depending on the printer you are using.

Displays to execute the connection performance measurement.

➔ [Connection Performance Measurement Screen \(Initial Screen\)](#)

➔ [Connection Performance Measurement Screen \(Completion Screen\)](#)

## Connection Performance Measurement Screen (Initial Screen)

Click **Next>** to start measurement.

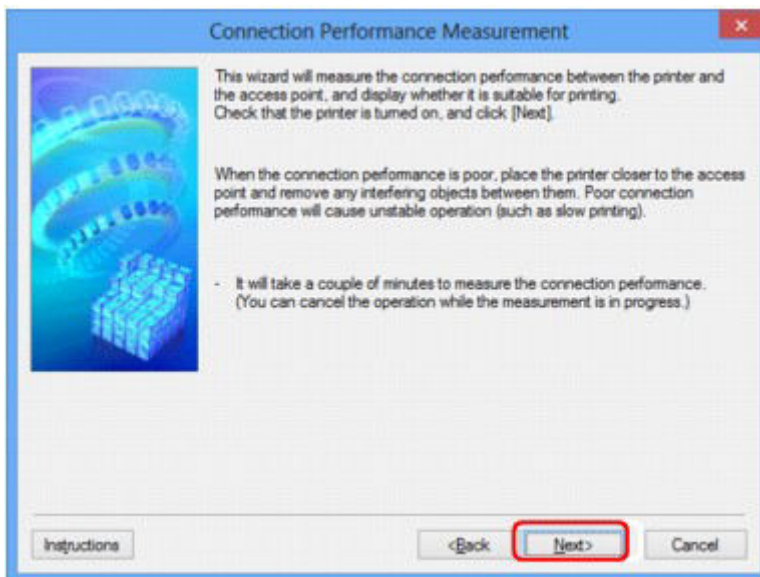

## Connection Performance Measurement Screen (Completion Screen)

Displays when the measurement is finished.

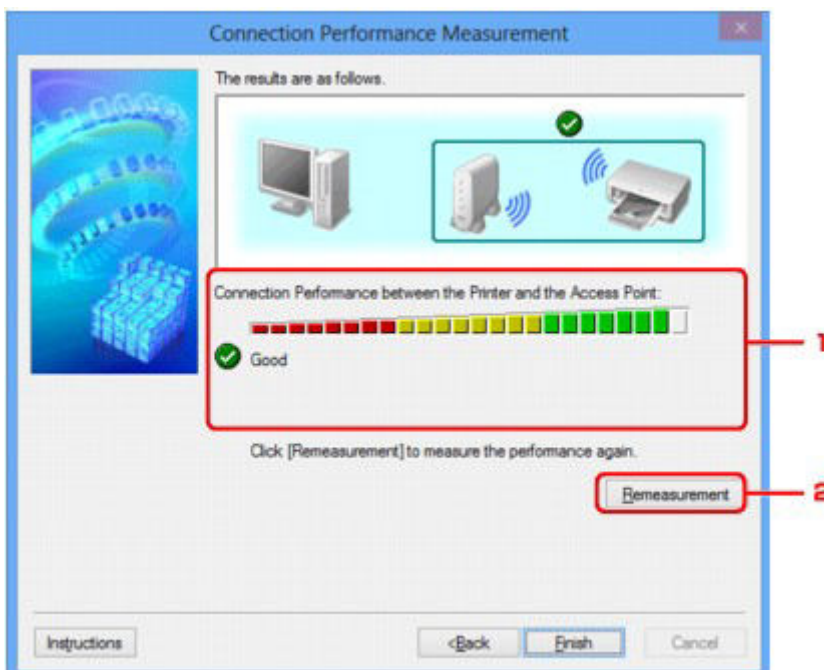

## 1. Connection Performance between the Printer and the Access Point:

A mark indicates the result of the connection performance measurement between the printer and the access point.



: Good connection performance



: Unstable connection performance



: Cannot connect



: Measurement is canceled, or cannot measure

## 2. Remeasurement

Measures the connection performance again.

### ▶▶ Note

- If any messages appear on **Overall Network Performance**:, move the machine and access point as instructed to improve the performance.

# Maintenance Screen

Displays to perform **Setting Initialization** and **Network Setup of the Card Slot**.

To display the **Maintenance** screen, select **Maintenance...** from the **Settings** menu.

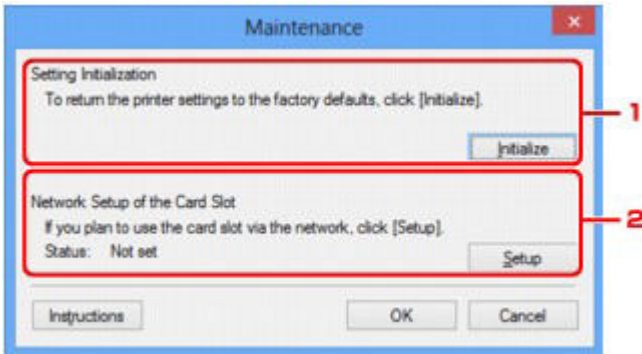

## 1. Setting Initialization

Reverts all the network settings of the printer to factory default. Click **Initialize** to display the **Initialize Settings** screen and click **Yes** to initialize the network settings of the printer. Do not turn off the printer during initialization. Click **OK** when initialization is complete.

Performing initialization when connected over wireless LAN will break the connection, so perform setup with the Setup CD-ROM or perform setup according to the instructions on our website.

## 2. Network Setup of the Card Slot

### ▶▶▶ Note

- This item is not available depending on the printer you are using.

**Status** displays whether the card slot is mapped as a network drive.

When you click, the **Network Setup of the Card Slot** is displayed.

➔ [Network Setup of the Card Slot Screen](#)

## Network Setup of the Card Slot Screen

### ▶▶▶ Note

- This screen is not available depending on the printer you are using.

Displays settings of the card slot and allows you to map a card slot on the network as a network drive on the computer.

Displays when you click **Setup** on the **Maintenance** screen.

➔ [Network Setup of the Card Slot Screen \(Setup Screen\)](#)

➔ [Network Setup of the Card Slot Screen \(Setup Failed Screen\)](#)

### ▶▶▶ Note

- You can change the network settings of the printer using IJ Network Tool with USB connection after initializing the LAN settings. To change the network settings using IJ Network Tool, activate the LAN settings in advance.

## Network Setup of the Card Slot Screen (Setup Screen)

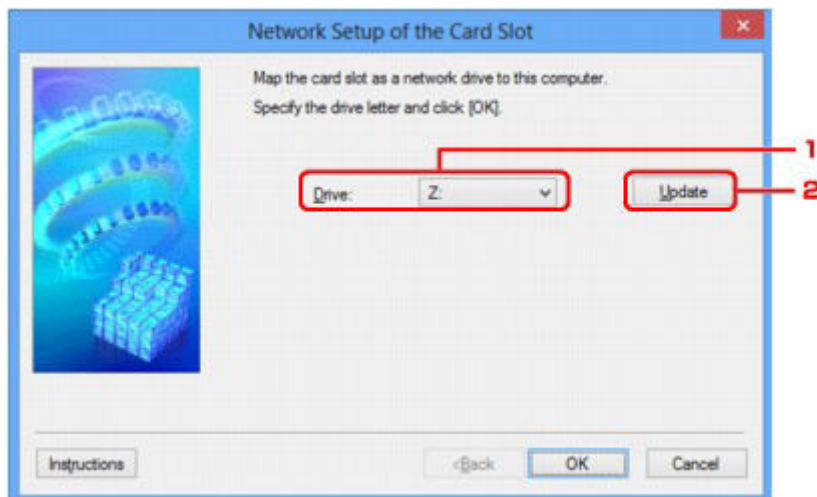

### 1. Drive:

Select the drive letter to assign to the network drive.

### 2. Update

Reloads the drive letters that are unassigned in **Computer (My Computer in Windows XP)** and displays them in the **Drive:** list.

## Network Setup of the Card Slot Screen (Setup Failed Screen)

Display when the network setup of the card slot is failed.

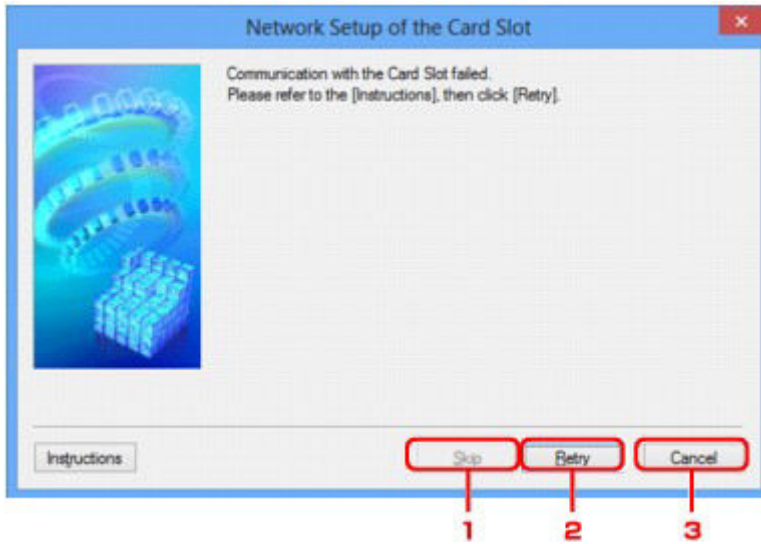

### 1. Skip

Completes the setup without mapping a network drive to the card slot.

### 2. Retry

Returns to **Network Setup of the Card Slot** screen and re-executes the network drive mapping.

### 3. Cancel

Cancels the card slot setup. When IJ Network Tool is running over LAN, the **Cancel** button is displayed grayed out and cannot be clicked.



# Associate Port Screen

Allows you to associate a created port with a printer driver.

Select the printer for which you want to change the association, then click **OK**.

## ▶▶▶ Note

- You cannot print with the printer unless the printer driver is associated with the port.

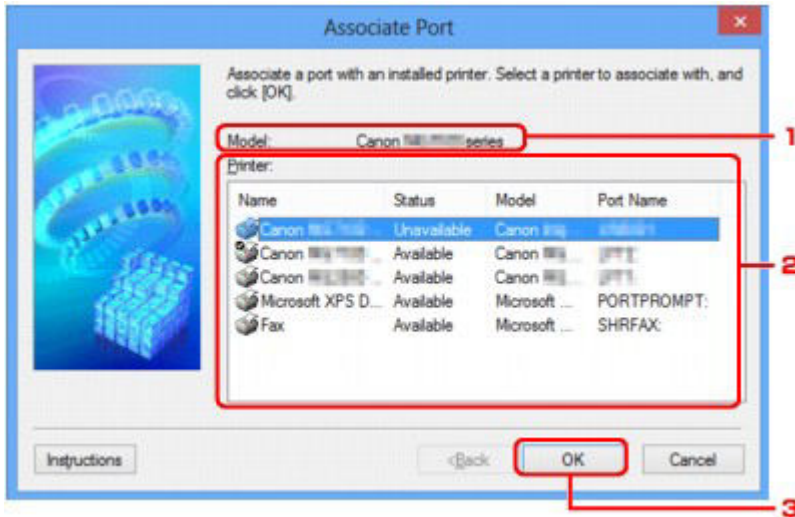

### 1. Model:

Displays the name of device specified as a destination port.

It is blank if the name of device is not detected.

### 2. Printer:

Displays the printer driver installed in the computer.

Select the printer for which you want to change the association.

### 3. OK

Performs association.

# Network Information Screen

Display the network information that is set for the printers and the computers.

To display the **Network Information** screen, select **Network Information** from the **View** menu.

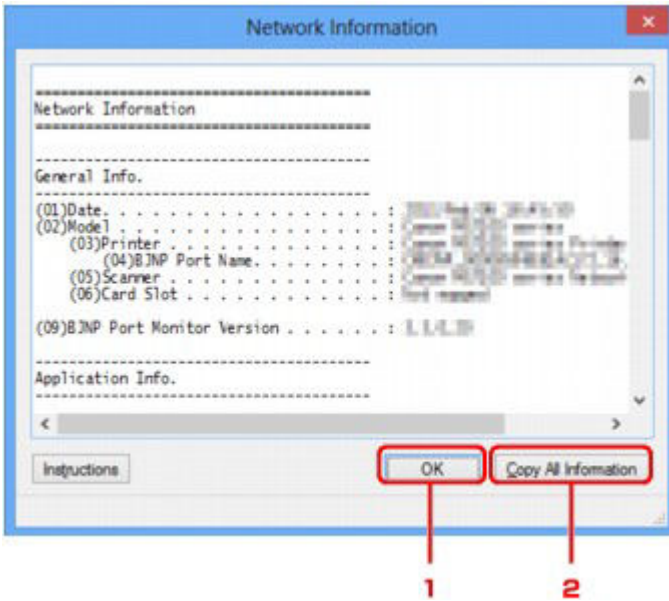

## 1. OK

Returns to the **Canon IJ Network Tool** screen.

## 2. Copy All Information

All network information displayed is copy to the clipboard.

## **Appendix for Network Communication**

- **Using the Card Slot over a Network**
- **When the Printer Driver Is Not Associated with a Port**
- **About Technical Terms**
- **Restrictions**
- **About Firewall**

# Using the Card Slot over a Network

## ►►► Note

- This screen is not available depending on the printer you are using.

➔ [Mounting the Card Slot as the Network Drive](#)

➔ [Restrictions on Card Slot Use over a Network](#)

## Mounting the Card Slot as the Network Drive

The card slot must be mounted to use it over a network.

To mount the card slot as the network drive, follow the procedure below.

1. Insert a memory card into the card slot of the machine.
2. [Start up IJ Network Tool.](#)
3. Select the machine in **Printers:**.
4. Select **Maintenance...** on the **Settings** menu.
5. Click **Setup**.

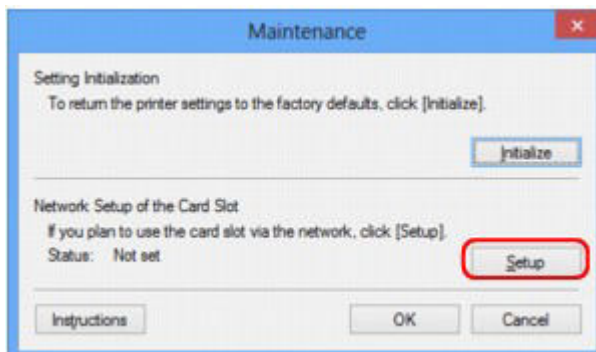

6. Specify the drive letter, then click **OK**.

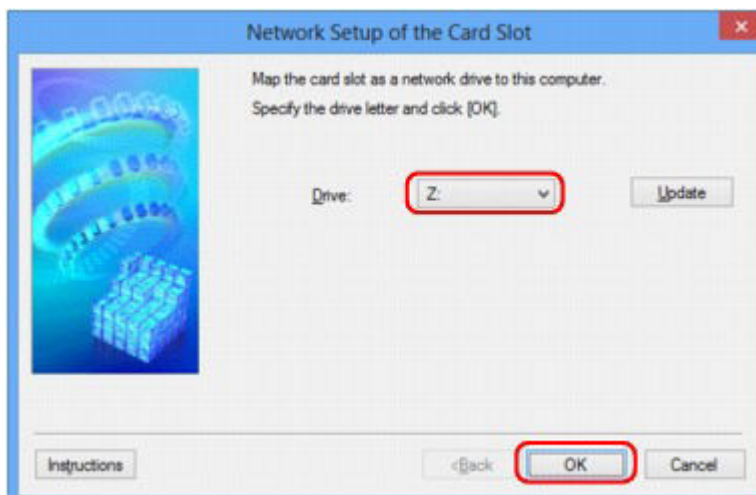

## 7. Make sure that the card slot is mounted.

When the card slot is mounted, the following icon appears on **Computer** (or **My Computer**).

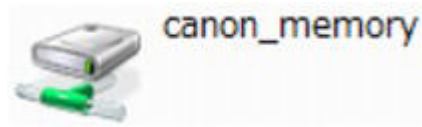

## Restrictions on Card Slot Use over a Network

- The card slot can be shared by multiple computers, if the machine is connected to a network. Multiple computers can read files from a memory card in the card slot at the same time. However, while one computer is writing a file into a memory card, other computers cannot access the same file.
- If your computer joins a domain, the card slot may not be mounted as the network drive.
- If you use the memory card stored the large size files or many files, a large amount of card access may be generated. In this case, the operation in the memory card may be impossible or slow. Operate after the **Access** lamp of the machine is lit.

- When you access the network drive for the card slot over the network, file names consisting of eight or less lowercase letters (not including its extension) may be shown in uppercase.

For example, a file name such as "abcdefg.doc" will be "ABCDEFGG.DOC", while a name such as "AbcdeFG.doc" will appear the same.

The file is not actually renamed, but merely appears to be changed.

- When you enable a memory card in the card slot of the machine to be writable only from a USB-connected computer, you cannot access the network drive of the card slot. On the other hand, when you enable it to be writable only from a LAN-connected computer, the card slot is not detected via USB. Make sure that the card slot setting is selected properly according to your connection method.

To read files from a memory card via USB and over a network, disable the function to write files to a memory card from a computer. You cannot write files to a memory card in either way with this setting.

- When you enable a memory card in the card slot of the machine to be writable only from a LAN-connected computer, you can write files to a memory card from a computer connected to a network. Note that it may increase the risk that the data on the memory card is infected by computer viruses or accessed illegally.

It is recommended to use the access control function of the machine or connect to the Internet via a router. For information on using a router, contact your Internet service provider or a network device manufacturer.

- If you write files to a memory card over a network when IJ Network Scanner Selector EX is not running, the Date Modified of the files may not be proper. Make sure to start up IJ Network Scanner Selector EX before you write files to a memory card over the network. For details, refer to "IJ Network Scanner Selector EX Menu and Setting Screen" from the HOME of your product's *Online Manual*.

## When the Printer Driver Is Not Associated with a Port

If **No Driver** is displayed for the printer's name on the **Canon IJ Network Tool** screen, the printer driver is not associated with a created port.

To associate a port with a printer driver, follow the procedure below.

1. [Start up IJ Network Tool.](#)
2. Select the printer displayed as **No Driver** on **Name**.
3. Select **Associate Port...** on the **Settings** menu.

The **Associate Port** screen is displayed.

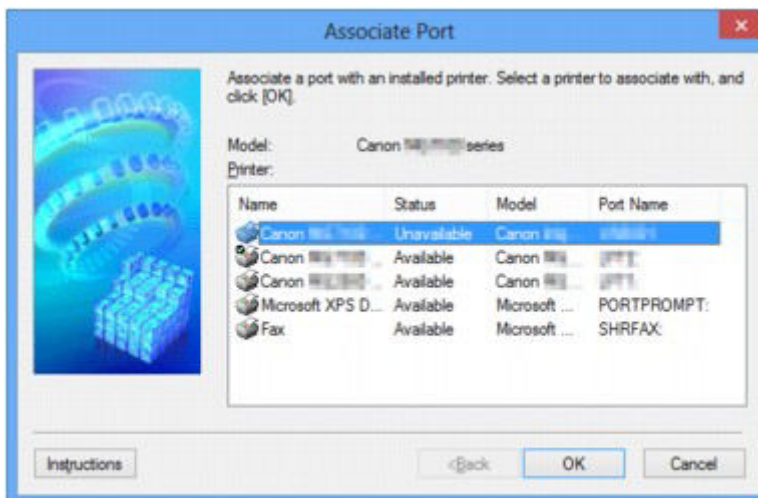

4. Select a printer to associate with a port.

The list of the printers that the printer driver is installed is displayed at **Printer:** on the **Associate Port** screen. Select a printer to associate with a created port.

5. Click **OK**.

# About Technical Terms

In this section, technical terms used in the manual are explained.

➡ [A](#)

➡ [B](#)

➡ [C](#)

➡ [D](#)

➡ [E](#)

➡ [I](#)

➡ [K](#)

➡ [L](#)

➡ [M](#)

➡ [O](#)

➡ [P](#)

➡ [R](#)

➡ [S](#)

➡ [T](#)

➡ [U](#)

➡ [W](#)

## A

- **Access Point**

A wireless transceiver or base station that receives information from wireless clients/the machine and rebroadcasts it. Required in an infrastructure network.

- **Ad-hoc**

Client computer and machine setting where wireless communication occurs on a peer-to-peer basis, i.e., all clients in with the same SSID/network name communicate directly with each other. No access point is required. This machine does not support ad-hoc communication.

- **Admin Password**

Administration password in IJ Network Tool to restrict access to network users. It must be entered to access the printer and change printer settings.

When the printer's network settings are factory default, the admin password does not have to be entered.

- **AES**

An encryption method. It is optional for WPA. Strong cryptographic algorithm adopted within U.S. government organizations for information processing.

- **Authentication Method**

The method that an access point uses to authenticate a printer through a wireless LAN. The methods are agreeable each other.

When using WEP as an encryption method, the authentication method is able to fix to **Open System** or **Shared Key**.

For WPA/WPA2, authentication method is PSK.

- **Auto**

The printer automatically changes its authentication method to match the access point.

- **Open System**

In this authentication method, the communication partner is authenticated without using WEP key even if **Use WEP** is selected.

- **Shared Key**

In this authentication method, the communication partner is authenticated using the WEP key that was set for encryption.

## **B**

- **Bonjour**

A service built into Mac OS X operating system to detect the connectable devices on a network automatically.

## **C**

- **Channel**

Frequency channel for wireless communication. In the infrastructure mode, the channel is automatically adjusted to match that set to the access point. This machine supports channels 1 to 13. Note that the number of channels that can be used for your wireless LAN varies depending on the region or country.

## **D**

- **Default Gateway**

A relay device to connect to another network such as a router or a computer.

- **DHCP server functionality**

The router or the access point assigns an IP address automatically whenever the printer or the personal computer on a network starts up.

- **DNS server**

A server that converts device names into IP addresses. When specifying IP addresses manually, specify the addresses of both a primary and a secondary server.

## **F**

- **Firewall**

It is a system that prevents an unlawful computer access in the network. To prevent, you can use the firewall function of a broadband router, the security software installed in the computer, or operation system for computer.



## I

- **IEEE 802.11b**

International standard for wireless LAN using the 2.4 GHz frequency range with a throughput of up to 11 Mbps.

- **IEEE 802.11g**

International standard for wireless LAN using the 2.4 GHz frequency range with a throughput of up to 54 Mbps. Compatible with 802.11b.

- **IEEE 802.11n**

International standard for wireless LAN using the 2.4 GHz and 5 GHz frequency ranges. Even when using two or more antennas simultaneously or obtaining a bigger transfer rate than before by using multiple communication channels at the same time, the transmission speed may be influenced by the connected apparatus.

At the maximum transfer rate of 600 Mbps, it is possible to communicate with multiple computer terminals within a dozen or so metre radius.

Compatible with 802.11b and 802.11g.

- **Infrastructure**

Client computer and machine setup where all wireless communications pass through an access point.

- **IP Address**

A unique number with four parts separated by dots. Every network device that is connected to the Internet has an IP address. Example: 192.168.0.1

An IP address is usually assigned by an access point or a DHCP server of the router automatically.

- **IPv4/IPv6**

They are internetwork-layer protocol used on the internet. IPv4 uses 32-bit addresses and IPv6 uses 128-bit addresses.

## K

- **Key Format**

Select either **ASCII** or **Hex** as the WEP key format. The character that can be used for the WEP key differs depending on the selected key formats.

- ASCII

Specify with a 5 or 13-character string that can include alphanumeric and underscore "\_" characters. It is case-sensitive.

- Hex

Specify a 10-digit or 26-digit string that can contain hexadecimal (0 to 9, A to F, and a to f).

- **Key Length**

Length of the WEP key. Select either 64 bits or 128 bits. Longer key length allows you to set a more complex WEP key.

## L

- **Link Quality**

The status of connection between the access point and the printer excluding noise (interference) is indicated with a value from 0 to 100%.

- **LPR**

A platform-independent printing protocol used in TCP/IP networks. It is not supported bidirectional communication.

## M

- **MAC Address**

Also known as the physical address. A unique and permanent hardware identifier that is assigned to network devices by its manufacturer. MAC addresses are 48 bits long and are written as a hexadecimal number separated by colons, i.e., 11:22:33:44:55:66.

## O

- **Operation Status**

Indicates the status on whether the printer can be used.

## P

- **Proxy server**

A server that links a LAN-connected computer to the Internet. When using a proxy server, specify the address and the port number of the proxy server.

- **PSK**

An encryption method employed by WPA/WPA2.

## R

- **Router**

A relay device to connect to another network.

## S

- **Signal Strength**

The strength of the signal received by the printer from the access point is indicated with a value from 0 to 100%.

- **SSID**

Unique label for wireless LAN. It is often represented such as a network name or an access point name.

SSID distinguishes one wireless LAN from another to prevent interference.

The printer and all clients on a wireless LAN must use the same SSID in order to communicate with each other. The SSID can be up to 32 characters long, and is made up of alphanumeric characters. The SSID may also be referred to by its network name.

- **Stealth**

In the stealth mode, an access point hides itself by not broadcasting its SSID. The client must specify the SSID set to the access point to detect it.

- **Subnet Mask**

IP address has two components, the network address and the host address. Subnet Mask used to calculate the Subnet Mask address from the IP address. A Subnet Mask is usually assigned by an access point or a DHCP server of the router automatically.

Example:

IP Address: 192.168.127.123

Subnet Mask: 255.255.255.0

Subnet Mask Address: 192.168.127.0

## T

- **TCP/IP**

Suite of communications protocols used to connect hosts on the Internet or the LAN. This protocol allows different terminals to communicate with each other.

- **TKIP**

An encryption protocol employed by WPA/WPA2.

## U

- **USB**

Serial interface designed to enable you to "hot-swap" devices, i.e., by plugging and unplugging them without turning off the power.

## W

- **WCN (Windows Connect Now)**

Users running Windows Vista or later can obtain the setting information directly via wireless network (WCN-NET).

- **WEP/WEP Key**

An encryption method employed by IEEE 802.11. Shared security key used to encrypt and decrypt data sent over wireless networks. This printer supports key length of 64 bits or 128 bits, key format of ASCII code or Hexadecimal, and key number of 1 to 4.

- **Wi-Fi**

International association that certifies interoperability of wireless LAN products based on the IEEE 802.11 specification.

This machine is a Wi-Fi authorized product.

- **Wireless LAN**

A network that, instead of being connected by physical wires, is connected by a wireless technology, such as Wi-Fi.

- **WPA**

Security framework announced by the Wi-Fi Alliance in October 2002. The security has been strengthened more than WEP.

- Authentication

WPA defines the following authentication methods: PSK that can be used without an authentication server, plus WPA-802.1x that do require an authentication server.

This machine supports WPA-PSK.

- Passphrase

This encrypted key is used to perform WPA-PSK authentication.

The passphrase should be a string of 8 to 63 alphanumeric characters or a 64-digit hexadecimal value.

- **WPA2**

Security framework released by the Wi-Fi Alliance in September 2004 as a later version of WPA. Provides a stronger encryption mechanism through Advanced Encryption Standard (AES).

- Authentication

WPA2 defines the following authentication methods: PSK that can be used without an authentication server, plus WPA2-802.1x that do require an authentication server.

This machine supports WPA2-PSK.

- Passphrase

This encrypted key is used to perform WPA2-PSK authentication.

The passphrase should be a string of 8 to 63 alphanumeric characters or a 64-digit hexadecimal value.

- **WPS (Wi-Fi Protected Setup)**

WPS is a standard for easy and secure establishment of a wireless network.

There are 2 primary methods used in the Wi-Fi Protected Setup:

PIN entry: a mandatory method of setup for all WPS certified devices

Push button configuration (PBC): an actual push button on the hardware or through a simulated push button in the software.

## **Restrictions**

If you use a printer over the wireless LAN, the printer may recognize nearby wireless systems, you should set a network key (WEP, WPA, or WPA2) to the access point to encrypt wireless transmission. Wireless communication with a product that does not comply with the Wi-Fi standard cannot be guaranteed.

Connecting with too many computers may affect the printer performance, such as printing speed.

# About Firewall

A firewall is a function of the security software installed in the computer or operation system for computer, and is a system that is designed to prevent unauthorized access to a network.

## Precautions When a Firewall Function is Enabled

- A firewall function may limit communications between a printer and a computer. This may disable printer setup and communications.
- During the printer setup, you may be prompted to enable or disable communications, depending on the firewall function of the security software or operation system. If so, choose to enable communications.
- When using IJ Network Tool, you may be prompted to enable or disable communications, depending on the firewall function of the security software. If so, choose to enable communications.
- If you cannot set up the printer, temporarily disable the firewall function of the security software or operation system.

### ►► Important

- If you disabled the firewall function, disconnect your network from the Internet.

- Some applications (like the network configuration software) override firewall settings. Check the application's settings beforehand.
- If the printer you use is set to **Get IP address automatically**, the IP address changes every time the printer connects to the network. This may disable printer setup and communications, depending on the firewall settings. In this case, either change the firewall settings or assign a fixed IP address to the printer. An IP address can be set using IJ Network Tool.

➡ [Changing the Settings in the Wireless LAN Sheet](#)

➡ [Changing the Settings in the Wired LAN Sheet](#)

When assigning a fixed IP address to the printer, you will need to specify an IP address with which the computer can communicate.

### ►► Note

- For the operation system firewall settings or the security software firewall settings, refer to the instruction manual of the computer or software, or contact its manufacturer.

## **Tips for Ensuring Optimal Printing Quality**

- ▶ **Useful Information about Ink**
- ▶ **Key Points to Successful Printing**
- ▶ **Be Sure to Make Paper Settings after Loading Paper**
- ▶ **Canceling a Print Job**
- ▶ **Printer Handling Precautions**
- ▶ **Key to Enjoying Consistent Printing Quality**
- ▶ **Precautions for Safe Transport of the Printer**

## Useful Information about Ink

### How is ink used for various purposes other than printing?

Ink may be used for purposes other than printing.

When you use the Canon printer for the first time after you install the bundled ink tanks, the printer consumes a small amount of ink in the amount to enable printing by filling the nozzles of the Print Head with ink. For this reason, the number of sheets that can be printed with the first ink tanks is fewer than the succeeding ink tanks.

The printing costs described in the brochures or websites are based on the consumption data from not the first ink tank /ink cartridge but the succeeding ink tank /ink cartridge.

Ink is sometimes used to maintain the optimal printing quality.

To keep printer's performance, Canon printer performs cleaning automatically according to its condition. When the printer performs cleaning, a small amount of ink is consumed. In this case, all colors of ink may be consumed.

#### [Cleaning function]

The cleaning function helps the printer to suck air bubbles or ink itself from the nozzle and thus prevents print quality degradation or nozzle clogging.

### Does black-and-white printing use color ink?

Black-and-white printing may use ink other than black ink depending on the type of printing paper or the settings of the printer driver. So, color ink is consumed even when printing in black-and-white.

### Why does the printer have two black ink tanks?

There are two kinds of black ink in the printer: dye ink (BK) and pigment ink (PGBK).

The dye ink is used mainly for printing photos, illustration, etc., and the pigment ink is used for text-based documents. Each has different purposes so that even if one runs out, another will not be used instead. If either of them runs out, the ink tank replacement is required.

These two inks are automatically used depending on the type of printing paper or the settings of the printer driver. You cannot change the usage of these inks yourself.

### The ink lamp indicates when ink is running low.

The inside of the ink tank consists of (A) the part where ink is preserved and (B) the sponge with absorbed ink.

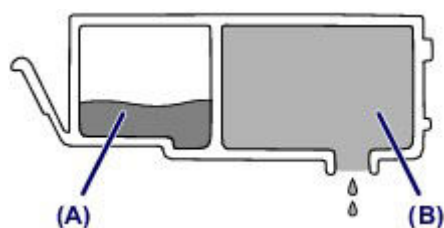

When the ink (A) runs out, the ink lamp flashes slowly to indicate that the ink is running low.

Then, when the ink (B) runs out, the ink lamp flashes fast to indicate that the ink tank needs to be replaced with a new one.



➡ [Checking the Ink Status with the Ink Lamps](#)

# Key Points to Successful Printing

## Check the printer status before printing!

- Is the print head OK?

If a print head nozzle is clogged, print will be faint and papers will be wasted. Print the nozzle check pattern to check the print head.

➔ [Maintenance Procedure](#)

- Is the inside of the printer smeared with ink?

After printing large quantities of paper or performing borderless printing, the area where papers go through may get smeared with ink. Clean the inside of your printer with [Bottom Plate Cleaning](#).

## Check how to load the paper correctly!

- Is the paper loaded in the correct orientation?

To load paper in the rear tray, load paper WITH THE PRINT SIDE FACING YOU.

➔ [Loading Paper](#)



- Is the paper curled?

The curled paper causes paper jam. Flatten the curled paper, then reload it.

➔ "Load the paper after correcting its curl." in [Paper Is Smudged/Printed Surface Is Scratched](#)

## Be Sure to Make Paper Settings after Loading Paper

If the media type setting is not the one for the loaded paper, printing results may not be satisfactory. After loading paper, be sure to select the appropriate media type setting for the loaded paper.

➔ [Print Results Not Satisfactory](#)

There are various types of paper: paper with special coating on the surface for printing photos with optimal quality and paper suitable for documents.

Each media type has specific preset settings, such as how ink is used and sprayed, distance from nozzles, etc., so that you can print on that type with optimal image quality.

This allows you to print with the settings best suited for the loaded media type just by selecting that media type.

## Canceling a Print Job

### Never press the ON button!

If you press the **ON** button while printing is in progress, the print data sent from the computer queues in the printer and you may not be able to continue to print.

Press the **RESUME/CANCEL** button to cancel printing.

## Printer Handling Precautions

### Do not place any object on the top cover!

Do not place any object on the top cover. It will fall into the rear tray when the top cover is opened and cause the printer to malfunction. Also, place the printer where objects will not fall on it.



## Key to Enjoying Consistent Printing Quality

The key to printing with the optimal printing quality is to prevent the print head from drying or clogging. Always observe the following rules for optimal printing quality.

### Never unplug the power cord until the power is turned off!

If you press the **ON** button to turn off the power, the printer caps the print head (nozzles) automatically to prevent from drying. If you unplug the power cord from the wall outlet before the **POWER** lamp is not lit, the print head will not be capped properly and this will cause drying or clogging.

When [unplugging the power cord](#), make sure that the **POWER** lamp is not lit.

### Print periodically!

Just as the tip of a felt pen becomes dry and unusable if it has not been used for a long time, even if it is capped, the print head too, may become dried or clogged if the printer has not been used for a long time.

We recommend you to use the printer at least once a month.

#### ►► Note

- Depending on the type of paper, ink may blur if you trace the printed area with a highlight pen or paint-stick, or bleed if water or sweat comes in contact with the printed area.

## Precautions for Safe Transport of the Printer

When relocating the printer, make sure of the following.

### ▶▶▶ Important

- Pack the printer in a sturdy box so that it is placed with its bottom facing down, using sufficient protective material to ensure safe transport.
- With the print head and ink tank left installed in the printer, press the **ON** button to turn off the power. This allows the printer to automatically cap the print head, thus preventing it from drying.
- After packing, do not tilt the box containing the printer or turn it on its side or upside down. Doing so may cause the ink to leak during transport and cause damage to the printer.
- When a shipping agent is handling transport of the printer, have its box marked "THIS SIDE UP" to keep the printer with its bottom facing down. Mark also with "FRAGILE" or "HANDLE WITH CARE".

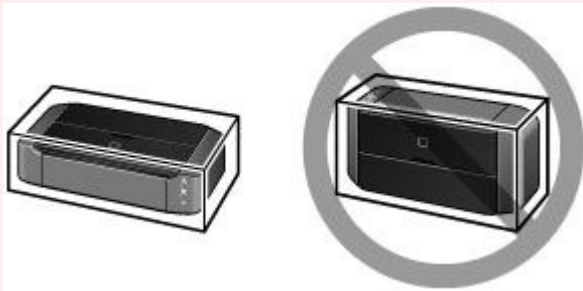

1. Turn the printer off.
2. Confirm that the **POWER** lamp is off and [unplug the power cord](#).

### ▶▶▶ Important

- Do not unplug the printer while the **POWER** lamp is lit or flashing white, as it may cause malfunction or damage to the printer, making the printer unable to print.

3. Retract the paper support, then close it.
4. Retract the paper output tray, then close the front cover gently.
5. Unplug the printer cable from the computer and from the printer, then unplug the power cord from the printer.
6. Remove the disc tray on the back of the printer.

### ▶▶▶ Note

- When packing the disc tray, be sure to use the protective material to prevent the transparency film on its leading edge from bending or peeling off.

7. Use adhesive tape to secure all the covers on the printer to keep them from opening during transportation. Then pack the printer in the plastic bag.
8. Attach the protective material to the printer when packing the printer in the box.

## Legal Limitations on Use of Your Product and Use of Images

It may be unlawful to print the following documents.

The list provided is non-exhaustive. When in doubt, check with a legal representative in your jurisdiction.

- Paper money
- Money orders
- Certificates of deposit
- Postage stamps (canceled or uncanceled)
- Identifying badges or insignias
- Selective service or draft papers
- Checks or drafts issued by governmental agencies
- Motor vehicle licenses and certificates of title
- Traveler's checks
- Food stamps
- Passports
- Immigration papers
- Internal revenue stamps (canceled or uncanceled)
- Bonds or other certificates of indebtedness
- Stock certificates
- Copyrighted works/works of art without permission of copyright owner



# Specifications

## General Specifications

<b>Printing resolution (dpi)</b>	9600* (horizontal) x 2400 (vertical) * Ink droplets can be placed with a pitch of 1/9600 inch at minimum.
<b>Interface</b>	<b>USB Port:</b> Hi-Speed USB *1 <b>LAN Port:</b> Wireless LAN: IEEE802.11n / IEEE802.11g / IEEE802.11b *2 *1 A computer that complies with Hi-Speed USB standard is required. Since the Hi-Speed USB interface is fully upwardly compatible with USB 1.1, it can be used at USB 1.1. *2 Setup possible through WPS (Wi-Fi Protected Setup), WCN (Windows Connect Now) or Cableless setup.
<b>Print width</b>	12.7 inches/322.2 mm (for Borderless Printing: 13 inches/329 mm)
<b>Operating environment</b>	<b>Temperature:</b> 41 to 95 °F (5 to 35 °C) <b>Humidity:</b> 10 to 90 % RH (no condensation) * The performance of the printer may be reduced under certain temperature and humidity conditions. Recommended conditions: <b>Temperature:</b> 59 to 86 °F (15 to 30 °C) <b>Humidity:</b> 10 to 80 % RH (no condensation) * For the temperature and humidity conditions of papers such as photo paper, refer to the paper's packaging or the supplied instructions.
<b>Storage environment</b>	<b>Temperature:</b> 32 to 104 °F (0 to 40 °C) <b>Humidity:</b> 5 to 95 % RH (no condensation)
<b>Power supply</b>	AC 100-240 V, 50/60 Hz
<b>Power consumption</b>	<b>Printing:</b> Approx. 23 W *1 <b>Standby (minimum):</b> Approx. 1.9 W *1*2 <b>OFF:</b> Approx. 0.3 W *1 Wireless LAN is active. *2 The wait time for standby cannot be changed.
<b>External dimensions</b>	Approx. 23.3 (W) x 13.1 (D) x 6.3 (H) inches Approx. 590 (W) x 331 (D) x 159 (H) mm * With the Paper Support and Paper Output Tray retracted.
<b>Weight</b>	Approx. 18.6 lb (Approx. 8.5 kg) * With the Print Head and ink tanks installed.
<b>Print Head/Ink</b>	Total 6656 nozzles (P/BK 1024 nozzles, Y/DyeBK each 512 nozzles, C/M/GY each 1536 nozzles)

## Network Specifications

<b>Communication protocol</b>	TCP/IP
<b>Wireless LAN</b>	<p><b>Supported Standards:</b> IEEE802.11n / IEEE802.11g / IEEE802.11b</p> <p><b>Frequency bandwidth:</b> 2.4 GHz</p> <p><b>Channel:</b> 1-11 or 1-13</p> <p>* Frequency bandwidth and available channels differ depending on country or region.</p> <p><b>Communication distance:</b> Indoors 164 feet/50 m</p> <p>* Effective range varies depending on the installation environment and location.</p> <p><b>Security:</b></p> <p>WEP (64/128 bits)</p> <p>WPA-PSK (TKIP/AES)</p> <p>WPA2-PSK (TKIP/AES)</p> <p><b>Setup:</b></p> <p>WPS (Push button configuration/PIN code method)</p> <p>WCN (WCN-NET)</p> <p>Cableless setup</p> <p><b>Other Features:</b> Administration password</p>

## Minimum System Requirements

Conform to the operating system's requirements when higher than those given here.

### Windows

<b>Operating System</b>	Windows 8, Windows 8.1 Windows 7, Windows 7 SP1 Windows Vista SP1, Windows Vista SP2 Windows XP SP3 32-bit only
<b>Browser</b>	Internet Explorer 8 or later
<b>Hard Disk Space</b>	3 GB Note: For bundled software installation. The necessary amount of hard disk space may be changed without notice.
<b>Display</b>	XGA 1024 x 768

### Mac OS

<b>Operating System</b>	Mac OS X v10.6.8 or later
<b>Browser</b>	Safari 5 or later
<b>Hard Disk Space</b>	1.5 GB Note: For bundled software installation.

	The necessary amount of hard disk space may be changed without notice.
<b>Display</b>	XGA 1024 x 768

## Other Supported OS

Some functions may not be available with each OS. Refer to the manual or the Canon web site for details on operation with iOS, Android, and Windows RT.

## Mobile Printing Capability

Apple AirPrint

Google Cloud Print

- An internet connection is required to view the *Online Manual*.
- Windows: Operation can only be guaranteed on a computer with Windows 8.1, Windows 8, Windows 7, Windows Vista or Windows XP pre-installed.
- Windows: A CD-ROM Drive or internet connection is required during software installation.
- Windows: Internet Explorer 8, 9 or 10 is required to install Easy-WebPrint EX.

Easy-WebPrint EX for Internet Explorer 9 or 10 can be downloaded from the Canon web site.

- Windows: Some functions may not be available with Windows Media Center.
- Windows: .NET Framework 4 or 4.5 must be installed to use the Windows software.
- Windows: XPS Essentials Pack is required to print on Windows XP.
- Mac OS: Hard Disk must be formatted as Mac OS Extended (Journaled) or Mac OS Extended.
- Mac OS: For Mac OS, an internet connection is required during software installation.

Specifications are subject to change without notice.

# Printing

## ▶ **Printing from a Computer**

- [Printing with Application Software that You are Using \(Printer Driver\)](#)

## ▶ **Printing from a Digital Camera**

- [Printing Photographs Directly from a PictBridge \(Wireless LAN\) Compliant Device](#)
- [About PictBridge \(Wireless LAN\) Print Settings](#)

## Printing from a Computer

- ▶ **Printing with Application Software that You are Using (Printer Driver)**

## Printing with Application Software that You are Using (Printer Driver)

- ➔ [Printing with Easy Setup](#)  **Basic**
- ➔ [Various Printing Methods](#)
- ➔ [Changing the Print Quality and Correcting Image Data](#)
- ➔ [Overview of the Printer Driver](#)
- ➔ [Printer Driver Description](#)
- ➔ [Updating the Printer Driver](#)

# Printing with Easy Setup

This section describes the simple procedure for setting the [Quick Setup tab](#) so that you can carry out appropriate printing on this printer.

1. [Check that the printer is turned on](#)
2. [Load paper](#) on the printer
3. Open the [printer driver setup window](#)
4. Select a frequently used profile

In **Commonly Used Settings** on the **Quick Setup** tab, select a printing profile suited for the purpose. When you select a printing profile, the **Additional Features**, **Media Type**, and **Printer Paper Size** settings are automatically switched to the values that were preset.

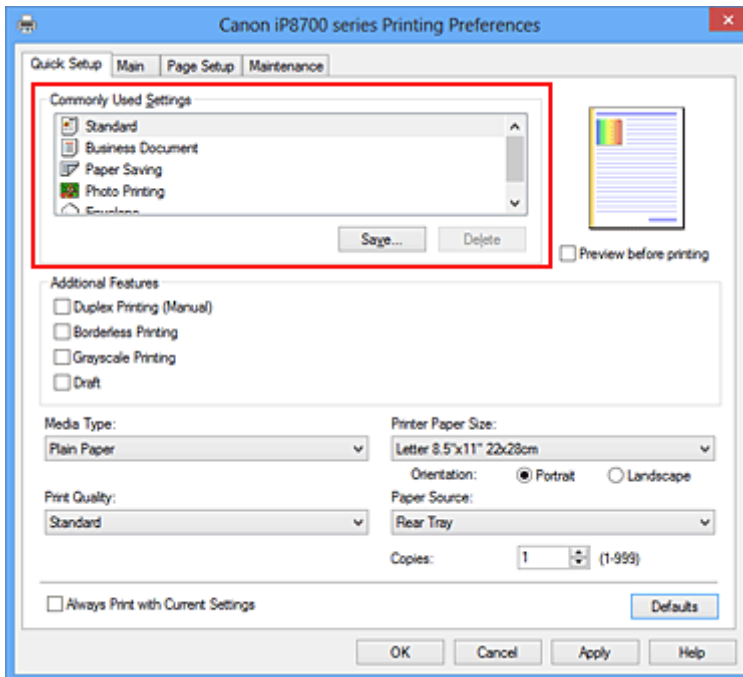

5. Select the print quality

For **Print Quality**, select **High**, **Standard**, or **Draft** according to your purpose.

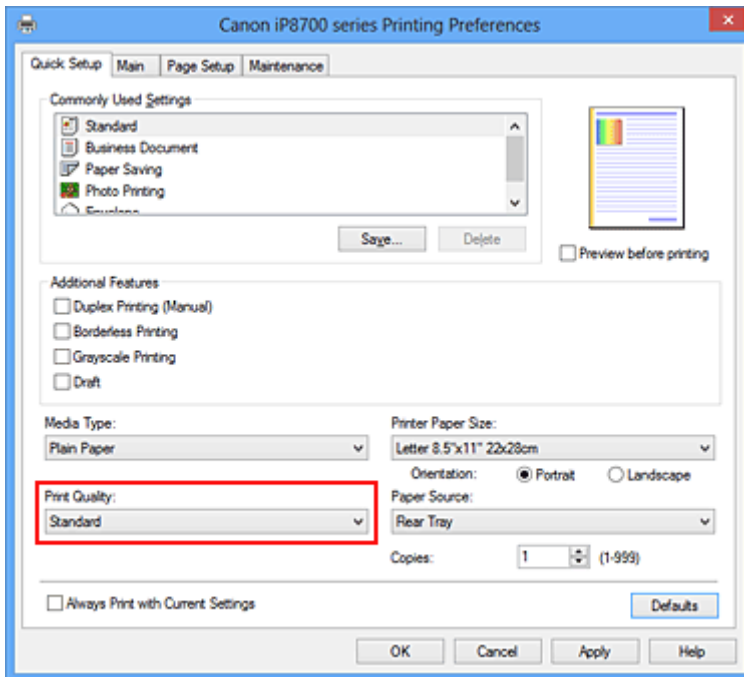

### ►►► Important

- The print quality settings that can be selected may differ depending on a printing profile.

## 6. Complete the setup

Click **OK**.

When you execute print, the document is printed with settings that match your purpose.

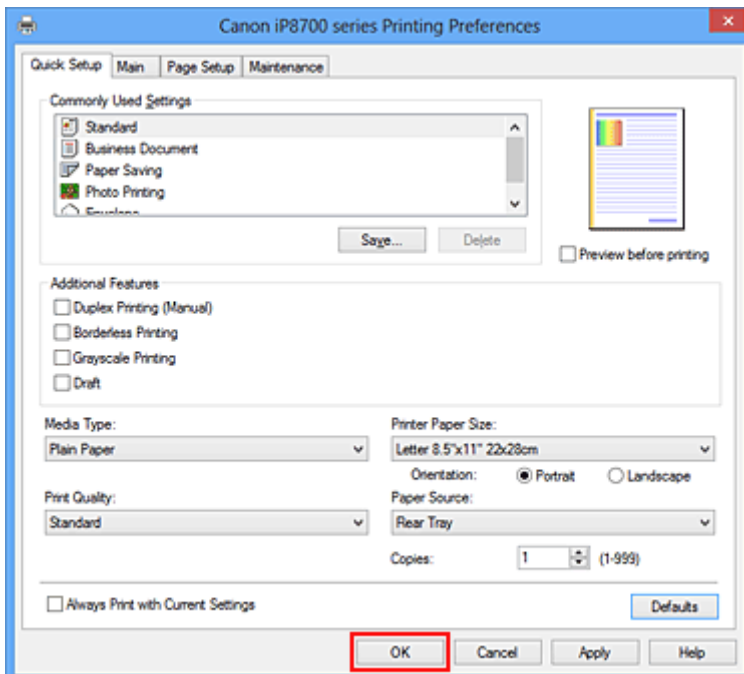

### ►►► Important

- When you select the **Always Print with Current Settings** check box, all settings specified on the **Quick Setup**, **Main**, and **Page Setup** tabs are saved, and you can print with the same settings from the next time as well.
- In the **Commonly Used Settings** window, click **Save...** to [register the specified settings](#).



## Setting the Media Type with the Printer Driver

When you use this printer, selecting a media type that matches the print purpose will help you achieve the best print results.

You can use the following media types on this printer.

### Commercially available papers

Media name	Media Type in the printer driver
Plain Paper (including recycled paper)	<b>Plain Paper</b>
Envelopes	<b>Envelope</b>

### Canon genuine papers (Photo Printing)

Media name <Model No.>	Media Type in the printer driver
Photo Paper Plus Glossy II <PP-201>	<b>Photo Paper Plus Glossy II</b>
Photo Paper Pro Platinum <PT-101>	<b>Photo Paper Pro Platinum</b>
Photo Paper Pro Luster <LU-101>	<b>Photo Paper Pro Luster</b>
Photo Paper Plus Semi-gloss <SG-201>	<b>Photo Paper Plus Semi-gloss</b>
Photo Paper Glossy <GP-501/GP-601>	<b>Glossy Photo Paper</b>
Matte Photo Paper <MP-101>	<b>Matte Photo Paper</b>

### Canon genuine papers (Business Letter Printing)

Media name <Model No.>	Media Type in the printer driver
High Resolution Paper <HR-101N>	<b>High Resolution Paper</b>

### Canon genuine papers (Original Products)

Media name <Model No.>	Media Type in the printer driver
T-Shirt Transfers <TR-301>	<b>T-Shirt Transfers</b>
Photo Stickers <PS-101>	<b>Photo Paper Plus Glossy II</b>

## Various Printing Methods

- ➔ [Setting a Page Size and Orientation](#)
- ➔ [Setting the Number of Copies and Printing Order](#)
- ➔ [Setting the Stapling Margin](#)
- ➔ [Execute Borderless Printing](#)
- ➔ [Fit-to-Page Printing](#)
- ➔ [Scaled Printing](#)
- ➔ [Page Layout Printing](#)
- ➔ [Tiling/Poster Printing](#)
- ➔ [Booklet Printing](#)
- ➔ [Duplex Printing](#)
- ➔ [Stamp/Background Printing](#)
- ➔ [Registering a Stamp](#)
- ➔ [Registering Image Data to be Used as a Background](#)
- ➔ [Setting Up Envelope Printing](#)
- ➔ [Printing on Postcards](#)
- ➔ [Displaying the Print Results before Printing](#)
- ➔ [Setting Paper Dimensions \(Custom Size\)](#)
- ➔ [Editing the Print Document or Reprinting from the Print History](#)

# Setting a Page Size and Orientation

The paper size and orientation are essentially determined by the application software. When the page size and orientation set for **Page Size** and **Orientation** on the **Page Setup** tab are same as those set with the application software, you do not need to select them on the **Page Setup** tab.

When you are not able to specify them with the application software, the procedure for selecting a page size and orientation is as follows:

You can also set page size and orientation on the **Quick Setup** tab.

1. Open the [printer driver setup window](#)
2. Select the paper size

Select a page size from the **Page Size** list on the **Page Setup** tab.

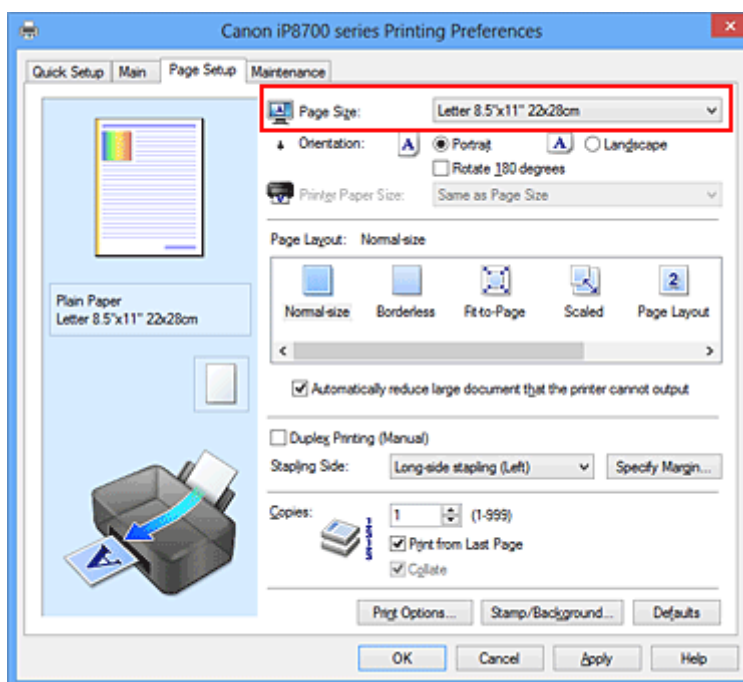

3. Set **Orientation**

Select **Portrait** or **Landscape** for **Orientation**. Check **Rotate 180 degrees** check box when you want to perform printing with the original being rotated 180 degrees.

4. Complete the setup

Click **OK**.

When you execute print, the document will be printed with the selected page size and the orientation.

## ▶▶▶ Note

- If **Normal-size** is selected for **Page Layout**, then **Automatically reduce large document that the printer cannot output** is displayed.

Normally, you can leave the check box checked. During printing, if you do not want to reduce large documents that cannot be printed on the printer, uncheck the check box.

# Setting the Number of Copies and Printing Order

The procedure for specifying the number of copies and printing order is as follows:  
You can also set the number of copies on the **Quick Setup** tab.

1. Open the [printer driver setup window](#)
2. Specify the number of copies to be printed

For **Copies** on the **Page Setup** tab, specify the number of copies to be printed.

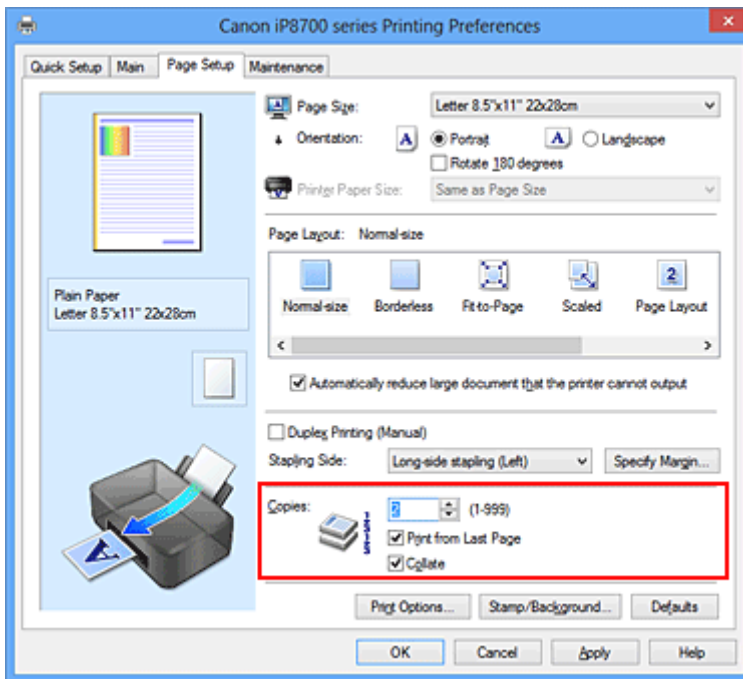

3. Specify the print order

Check the **Print from Last Page** check box when you want to print from the last page in order, and uncheck the check box when you want to print from the first page.

Check the **Collate** check box when you are printing multiple copies of a document and want to print out all pages in each copy together. Uncheck this check box when you want to print all pages with the same page number together.

- **Print from Last Page:**  / **Collate:**

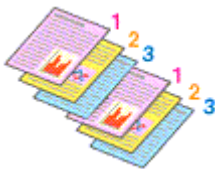

- **Print from Last Page:**  / **Collate:**

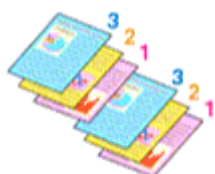

- **Print from Last Page:**  / **Collate:**

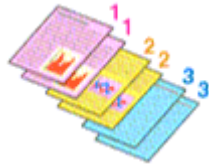

- **Print from Last Page:**  / **Collate:**

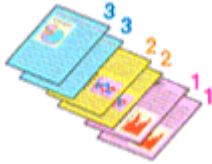

#### 4. Complete the setup

Click **OK**.

When you execute print, the specified number of copies will be printed with the specified printing order.

### ▶▶▶ Important

- When the application software that you used to create the document has the same function, specify the settings on the printer driver. However, if the print results are not acceptable, specify the function settings on the application software. When you specify the number of copies and the printing order with both the application software and this printer driver, the number of copies may be multiplied numbers of the two settings or the specified printing order may not be enabled.
- **Print from Last Page** appears grayed out and is unavailable when **Tiling/Poster** is selected for **Page Layout**.
- When **Booklet** is selected for **Page Layout**, **Print from Last Page** and **Collate** appear grayed out and cannot be set.
- When **Duplex Printing (Manual)** is selected, **Print from Last Page** appears grayed out and cannot be set.

### ▶▶▶ Note

- By setting both **Print from Last Page** and **Collate**, you can perform printing so that papers are collated one by one starting from the last page.  
These settings can be used in combination with **Normal-size**, **Borderless**, **Fit-to-Page**, **Scaled**, and **Page Layout**.

## Setting the Stapling Margin



The procedure for setting the staple side and the margin width is as follows:

1. Open the [printer driver setup window](#)
2. Specify the side to be stapled

Check the position of the stapling margin from **Stapling Side** on the **Page Setup** tab.

The printer analyzes the **Orientation** and **Page Layout** settings, and automatically selects the best staple position. When you want to change the setting, select from the list.

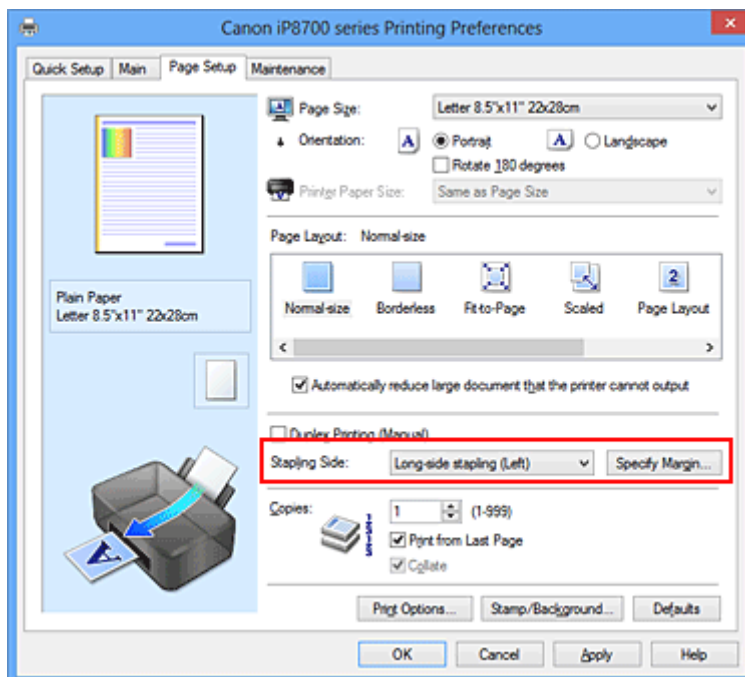

3. Set the margin width

If necessary, click **Specify Margin...** and set the margin width, and then click **OK**.

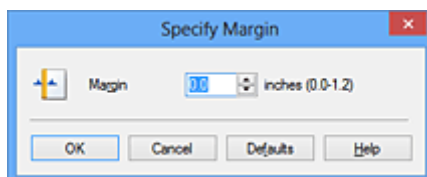

## ▶▶▶ Note

- The printer automatically reduces the print area depending on the staple position margin.

### 4. Complete the setup

Click **OK** on the **Page Setup** tab.

When you execute print, the data is printed with the specified staple side and margin width.

## ▶▶▶ Important

- **Stapling Side** and **Specify Margin...** appear grayed out and are unavailable when:
  - **Borderless, Tiling/Poster, or Booklet** is selected for **Page Layout**
  - **Scaled** is selected for **Page Layout** (When **Duplex Printing (Manual)** is also selected, only **Stapling Side** can be specified.)

## Execute Borderless Printing

The borderless printing function allows you to print data without any margin by enlarging the data so that it extends slightly off the paper. In standard printing, margins are created around the document area. However, in borderless printing function, these margins are not created. When you want to print data such as a photo without providing any margin around it, set borderless printing.

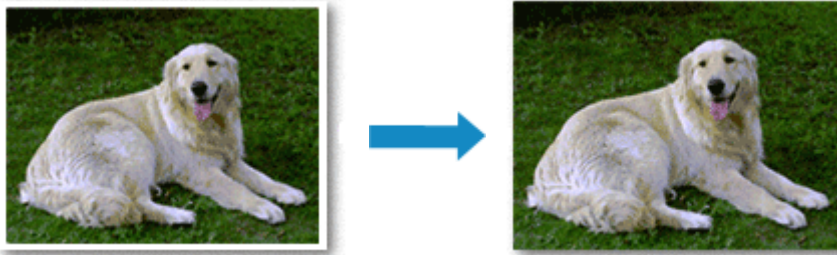

The procedure for performing borderless printing is as follows:

You can also set borderless printing in **Additional Features** on the **Quick Setup** tab.

### Setting Borderless Printing

1. Open the [printer driver setup window](#)
2. Set borderless printing

Select **Borderless** from the **Page Layout** list on the **Page Setup** tab.

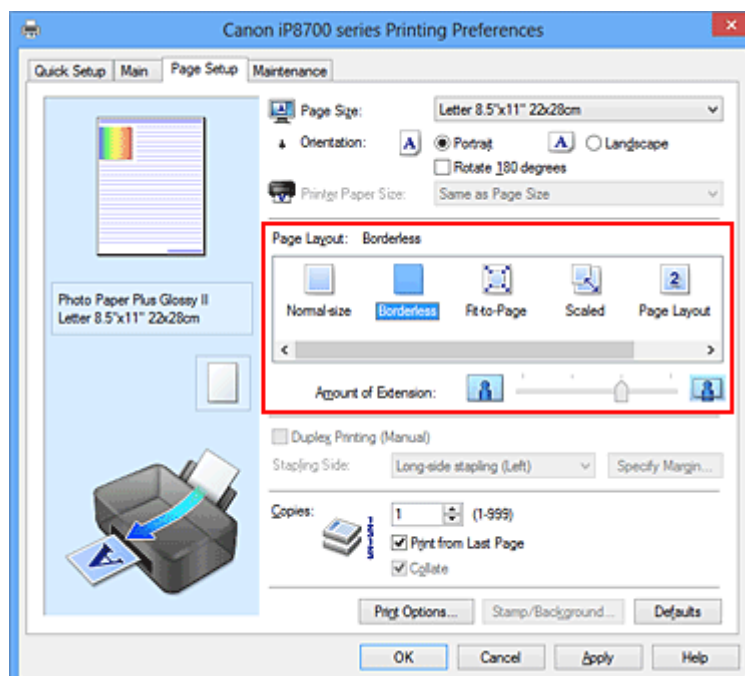

Click **OK** when the confirmation message appears.

When a message prompting you to change the media type appears, select a media type from the list and click **OK**.

3. Check the paper size



Check the **Page Size** list. When you want to change it, select another page size from the list. The list displays only sizes that can be used for borderless printing.

#### 4. Adjust the amount of extension from the paper

If necessary, adjust the amount of extension using the **Amount of Extension** slider.

Moving the slider to the right increases the amount extending off the paper, and moving the slider to the left decreases the amount.

It is recommended to set the slider at the second position from the right for most cases.



#### »» Important

- When the **Amount of Extension** slider is set to the rightmost position, the back side of the paper may become smudged.

#### 5. Complete the setup

Click **OK**.

When you execute print, the data is printed without any margins on the paper.

#### »» Important

- When a page size that cannot be used for borderless printing is selected, the size is automatically changed to the valid page sizes for borderless printing.
- When **Borderless** is selected, the **Printer Paper Size**, **Duplex Printing (Manual)**, **Stapling Side** settings, and the **Stamp/Background... (Stamp...)** button on the **Page Setup** tab appear grayed out and are unavailable.
- When **Other Fine Art Paper**, **Envelope**, **High Resolution Paper** or **T-Shirt Transfers** is selected from the **Media Type** list on the **Main** tab, you cannot perform borderless printing.
- Depending on the type of the media used during borderless printing, the print quality may deteriorate at the top and bottom of the sheet or stains may form.
- When the ratio of the height to the width differs from the image data, a portion of the image may not be printed depending on the size of the media used.  
In this case, crop the image data with an application software according to the paper size.

#### »» Note

- When **Plain Paper** is selected for **Media Type** on the **Main** tab, borderless printing is not recommended. Therefore, the message for media selection appears.  
When you are using plain paper for test printing, select **Plain Paper**, and click **OK**.

## Expanding the Range of the Document to Print

Setting a large amount of extension allows you to perform borderless printing with no problems. However, the portion of the document extending off the paper range will not be printed and for this reason, the subjects around the perimeter of a photo may not be printed.

When you are not satisfied with the result of borderless printing, reduce the amount of extension. The extension amount decreases as the **Amount of Extension** slider is moved to the left.

## »» Important

- When the amount of extension is decreased, an unexpected margin may be produced on the print, depending on the size of the paper.

## »» Note

- When the **Amount of Extension** slider is set to the leftmost position, image data will be printed in the full size. If you set this when printing the address side of a postcard, the postal code of the sender is printed in the correct position.
- When **Preview before printing** is checked on the **Main** tab, you can confirm whether there will be no margin before printing.

# Fit-to-Page Printing



The procedure for printing a document that is automatically enlarged or reduced to fit the page size to be used is as follows:

1. Open the [printer driver setup window](#)
2. Set fit-to-page printing

Select **Fit-to-Page** from the **Page Layout** list on the **Page Setup** tab.

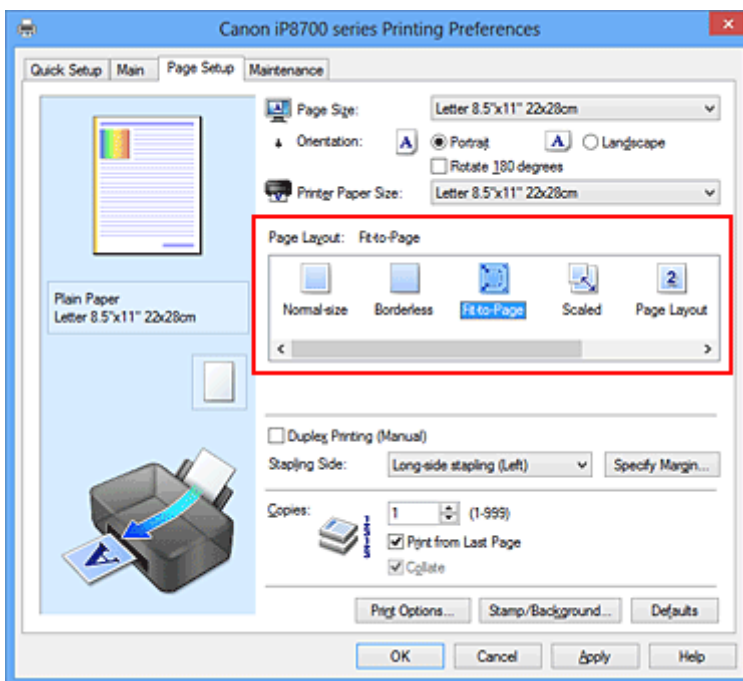

3. Select the paper size of the document

Using **Page Size**, select the page size that is set with your application software.

4. Select the print paper size

Select the size of the paper loaded in the printer from the **Printer Paper Size** list.

When the **Printer Paper Size** is smaller than the **Page Size**, the page image will be reduced. When the **Printer Paper Size** is larger than the **Page Size**, the page image will be enlarged.

The current settings are displayed in the settings preview on the left side of the printer driver.

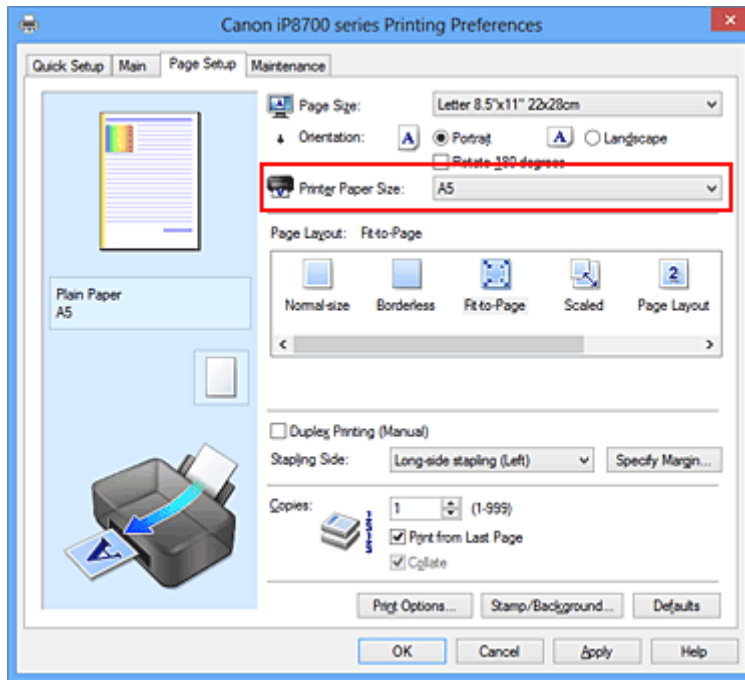

5. Complete the setup

Click **OK**.

When you execute print, the document will be enlarged or reduced to fit to the page size.

# Scaled Printing



The procedure for printing a document with pages enlarged or reduced is as follows:

1. Open the [printer driver setup window](#)
2. Set scaled printing

Select **Scaled** from the **Page Layout** list on the **Page Setup** tab.

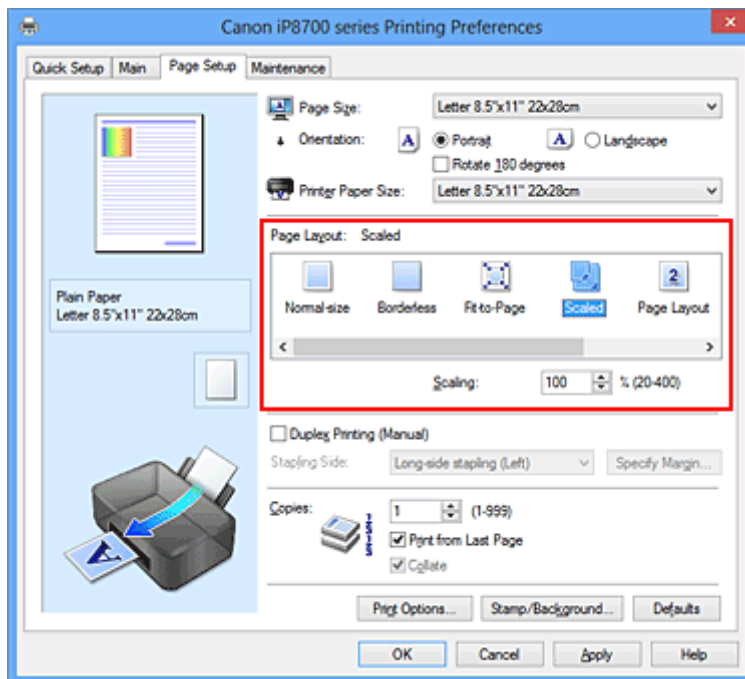

3. Select the paper size of the document

Using **Page Size**, select the page size that is set with your application software.

4. Set the scaling rate by using one of the following methods:

- Select a **Printer Paper Size**

When the printer paper size is smaller than the **Page Size**, the page image will be reduced. When the printer paper size is larger than the **Page Size**, the page image will be enlarged.

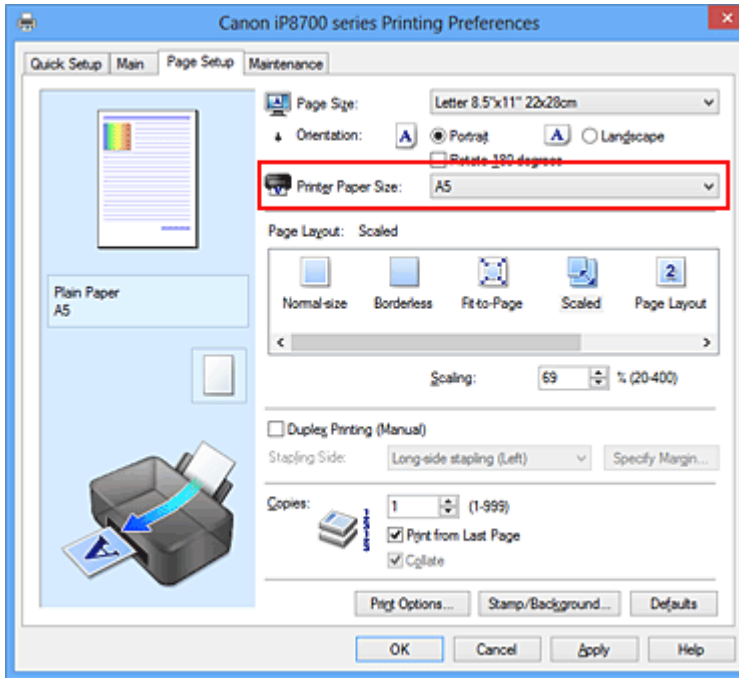

- Specify a scaling factor

Directly type in a value into the **Scaling** box.

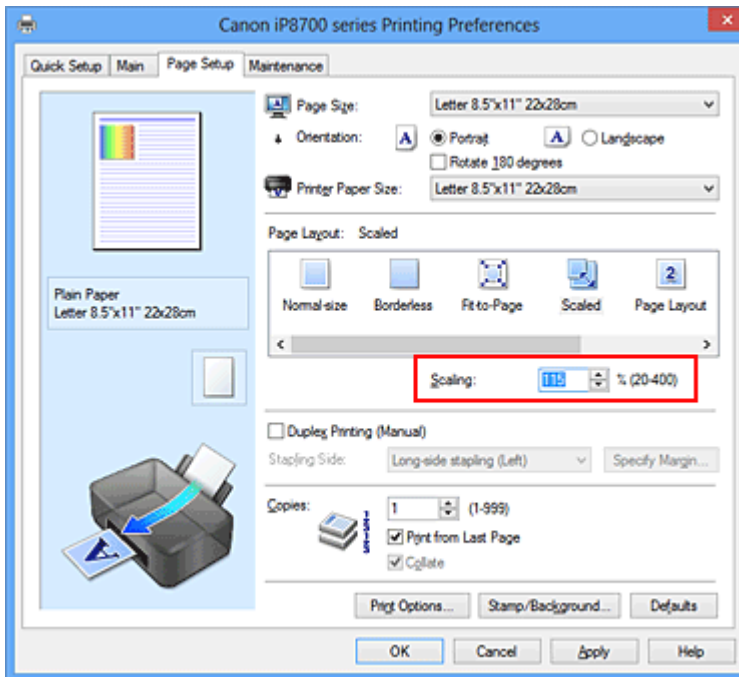

The current settings are displayed in the settings preview on the left side of the printer driver.

## 5. Complete the setup

Click **OK**.

When you execute print, the document will be printed with the specified scale.

### »»» Important

- When the application software which you used to create the original has the scaled printing function, configure the settings on your application software. You do not need to configure the same setting in the printer driver.

»» Note

- Selecting **Scaled** changes the printable area of the document.

# Page Layout Printing

The page layout printing function allows you to print more than one page image on a single sheet of paper.

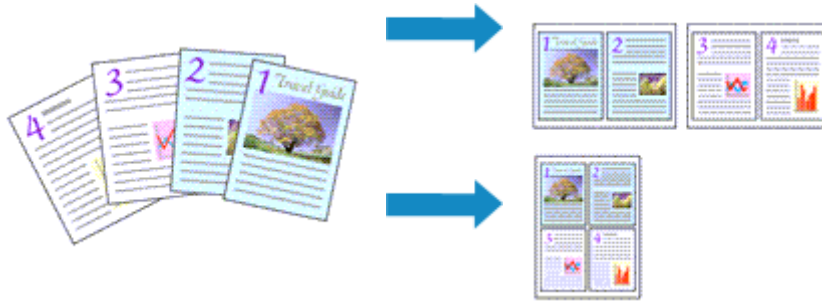

The procedure for performing page layout printing is as follows:

1. Open the [printer driver setup window](#)

2. Set page layout printing

Select **Page Layout** from the **Page Layout** list on the **Page Setup** tab.

The current settings are displayed in the settings preview on the left side of the printer driver.

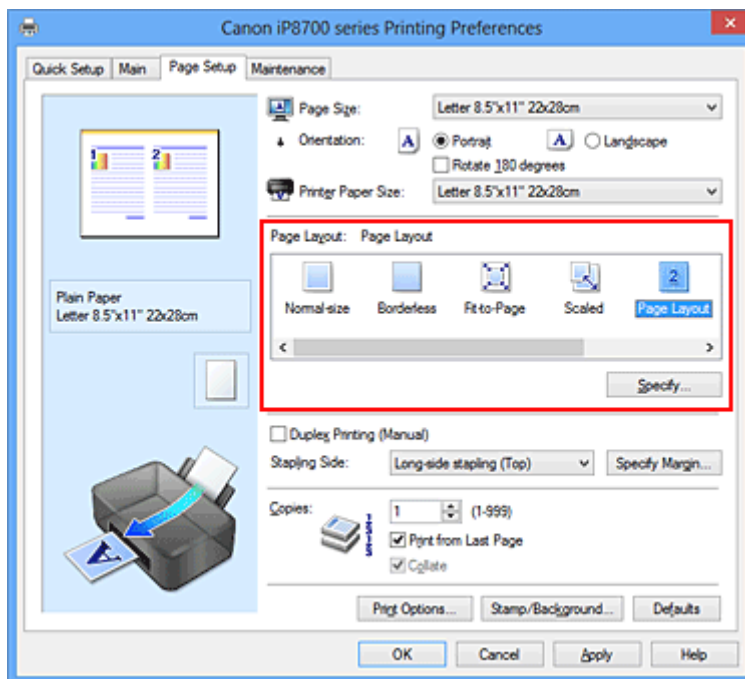

3. Select the print paper size

Select the size of the paper loaded in the printer from the **Printer Paper Size** list.

4. Set the number of pages to be printed on one sheet and the page order

If necessary, click **Specify...**, specify the following settings in the **Page Layout Printing** dialog box, and click **OK**.



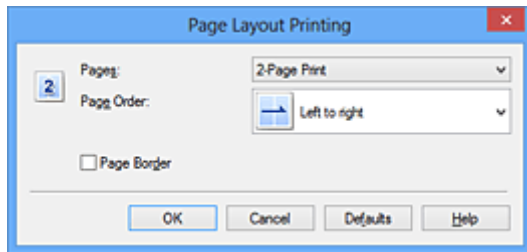

### **Pages**

To change the number of pages to be printed on a single sheet of paper, select the number of pages from the list.

### **Page Order**

To change the page arrangement order, select a placement method from the list.

### **Page Border**

To print a page border around each document page, check this check box.

## 5. Complete the setup

Click **OK** on the **Page Setup** tab.

When you execute print, the specified number of pages will be arranged on each sheet of paper in the specified order.

## Tiling/Poster Printing

The tiling/poster printing function allows you to enlarge image data, divide it into several pages, and print these pages on separate sheets of paper. You can also paste the pages together to create a large print like a poster.

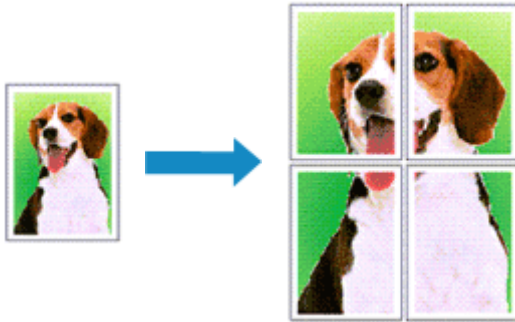

The procedure for performing tiling/poster printing is as follows:

### Setting Tiling/Poster Printing

1. Open the [printer driver setup window](#)
2. Set tiling/poster printing

Select **Tiling/Poster** from the **Page Layout** list on the **Page Setup** tab.

The current settings are displayed in the settings preview on the left side of the printer driver.

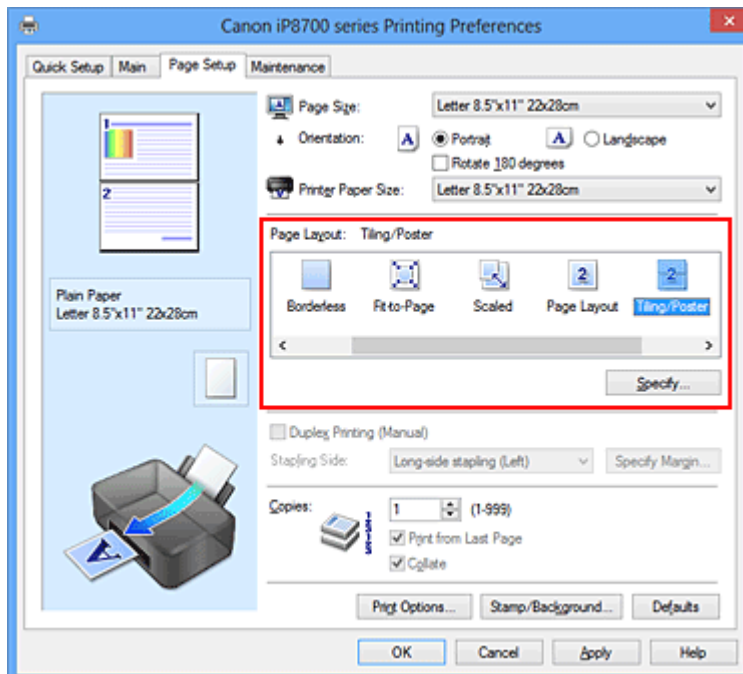

3. Select the print paper size

Select the size of the paper loaded in the printer from the **Printer Paper Size** list.

4. Set the number of image divisions and the pages to be printed

If necessary, click **Specify...**, specify the following settings in the **Tiling/Poster Printing** dialog box, and then click **OK**.

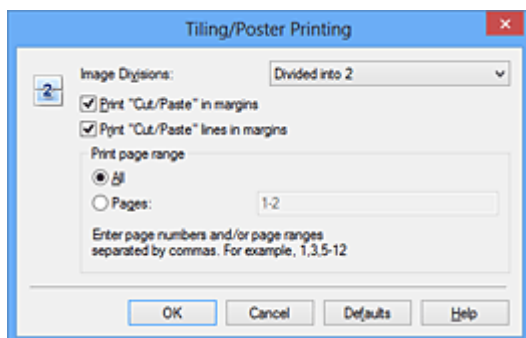

### Image Divisions

Select the number of divisions (vertical x horizontal).

As the number of divisions increases, the number of sheets used for printing increases. If you are pasting pages together to create a poster, increasing the number of divisions allows you to create a larger poster.

### Print "Cut/Paste" in margins

To leave out words "Cut" and "Paste", uncheck this check box.

#### ►►► Note

- This feature may be unavailable when certain printer drivers or operating environments are used.

### Print "Cut/Paste" lines in margins

To leave out cut lines, uncheck this check box.

### Print page range

Specifies the printing range. Select **All** under normal circumstances.

To reprint only a specific page, select **Pages** and enter the page number you want to print. To specify multiple pages, enter the page numbers by separating them with commas or by entering a hyphen between the page numbers.

#### ►►► Note

- You can also specify the print range by clicking the pages in the settings preview.

## 5. Complete the setup

Click **OK** on the **Page Setup** tab.

When you execute print, the document will be divided into several pages during printing.

## Printing Only Specific Pages

If ink becomes faint or runs out during printing, you can reprint only the specific pages by following the procedure below:

### 1. Set the print range

In the settings preview on the left of the **Page Setup** tab, click the pages that do not need to be printed.

The pages that were clicked are deleted, and only the pages to be printed are displayed.

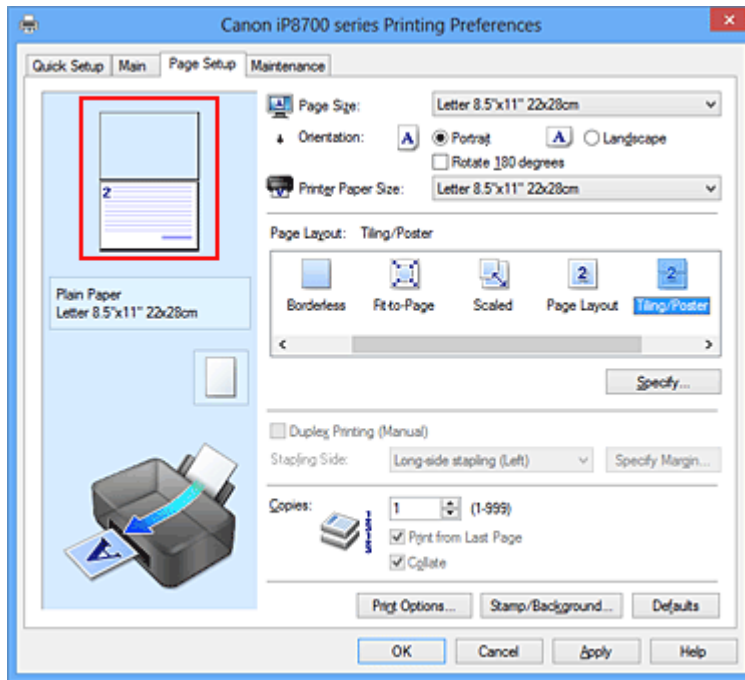

### ➤➤➤ Note

- Click the deleted pages to display them again.
- Right-click the settings preview to select **Print all pages** or **Delete all pages**.

## 2. Complete the setup

After completing the page selection, click **OK**.

When you execute print, only specified pages will be printed.

### ➤➤➤ Important

- Since tiling/poster printing enlarges the document when printing it, the print results may become coarse.

# Booklet Printing

The booklet printing function allows you to print data for a booklet. Data is printed on both sides of the paper. This type of printing ensures that pages can be collated properly, in page number order, when the printed sheets are folded and stapled at the center.

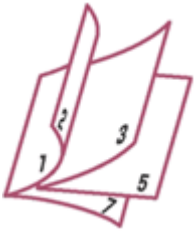

The procedure for performing booklet printing is as follows:

1. Open the [printer driver setup window](#)
2. Set booklet printing

Select **Booklet** from the **Page Layout** list on the **Page Setup** tab.

The current settings are displayed in the settings preview on the left side of the window.

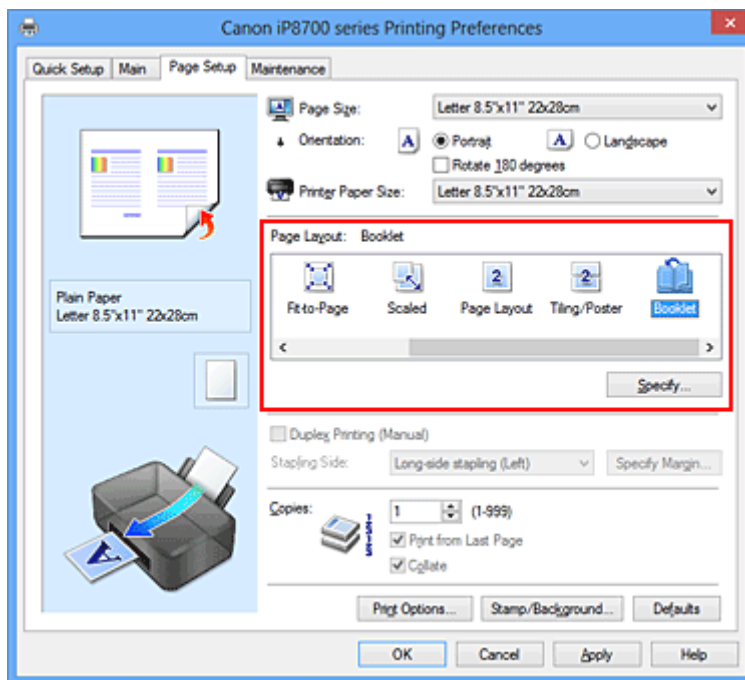

3. Select the print paper size

Select the size of the paper loaded in the printer from the **Printer Paper Size** list.

4. Set the margin for stapling and the margin width

Click **Specify...** and specify the following settings in the **Booklet Printing** dialog box, and then click **OK**.

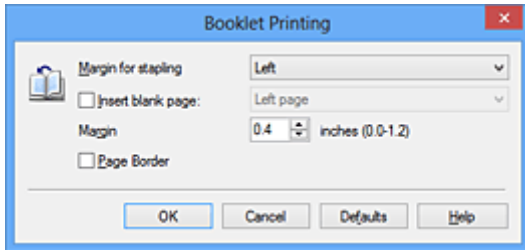

### Margin for stapling

Select which side should the stapling margin be on when the booklet is completed.

### Insert blank page

To leave one side of a sheet blank, check the check box, and select the page to be left blank.

### Margin

Enter the margin width. The specified width from the center of the sheet becomes the margin width for one page.

### Page Border

To print a page border around each document page, check the check box.

## 5. Complete the setup

Click **OK** on the **Page Setup** tab.

When you execute print, the document will be printed on one side of a sheet of paper. When the printing of one side is complete, set the paper correctly by following the message and click **OK**.

When the printing of the other side is complete, fold the paper at the center of the margin and make a booklet.

### »» Important

- **Booklet** cannot be selected when a media type other than **Plain Paper** is selected for **Media Type** on the **Main** tab.

### »» Note

- The stamp and background are not printed on the inserted blank sheets with the **Insert blank page** function of booklet printing.

# Duplex Printing



The procedure for printing data on both sides of a sheet of paper is as follows:  
You can also set duplex printing in **Additional Features** on the **Quick Setup** tab.

1. Open the [printer driver setup window](#)
2. Set duplex printing

Check the **Duplex Printing (Manual)** check box on the **Page Setup** tab.

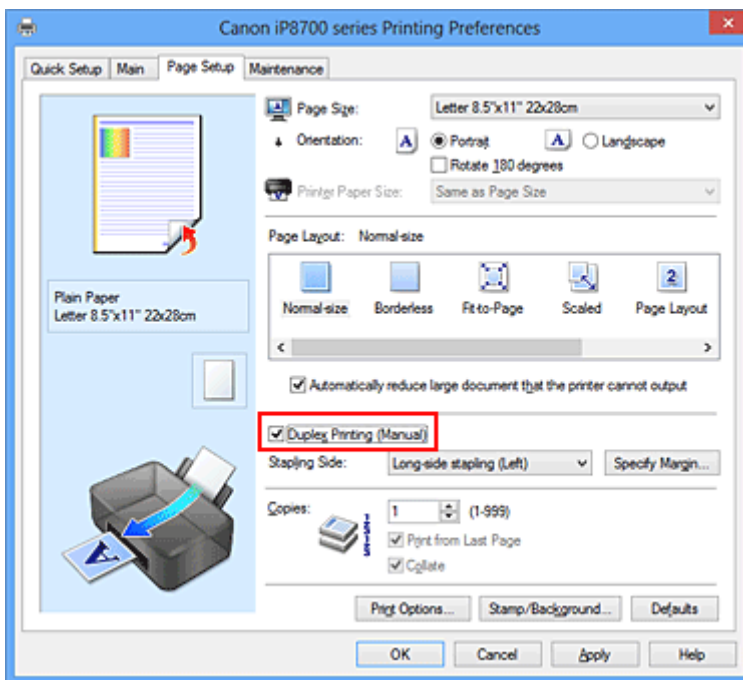

3. Select the layout

Select **Normal-size**, **Fit-to-Page**, **Scaled**, or **Page Layout** from the **Page Layout** list.

4. Specify the side to be stapled

The best **Stapling Side** is selected automatically from the **Orientation** and **Page Layout** settings. To change the setting, select another stapling side from the list.

5. Set the margin width

If necessary, click **Specify Margin...** and set the margin width, and then click **OK**.

6. Complete the setup

Click **OK** on the **Page Setup** tab.

When you execute print, the document is first printed on one side of a sheet of paper. After one side is printed, reload the paper correctly according to the message.

Then click **Start Printing** to print the opposite side.

### ▶▶▶ Important

- When a media type other than **Plain Paper** is selected from **Media Type** on the **Main** tab, **Duplex Printing (Manual)** appears grayed out and is unavailable.
- When **Borderless**, **Tiling/Poster** or **Booklet** is selected from the **Page Layout** list, **Duplex Printing (Manual)** and **Stapling Side** appear grayed out and are unavailable.

### ▶▶▶ Note

- If the back side of the paper becomes smudged during duplex printing, perform **Bottom Plate Cleaning** in the **Maintenance** tab.

## Related Topics

- ➔ [Cleaning Inside the Printer](#)
- ➔ [Changing the Printer Operation Mode](#)



# Stamp/Background Printing

**Stamp or Background** may be unavailable when certain printer drivers or operating environments are used.

The **Stamp** function allows you to print a stamp text or a bitmap over or behind document data. It also allows you to print date, time and user name. The **Background** function allows you to print a light illustration behind the document data.

The procedure for performing stamp/background printing is as follows:

## Printing a Stamp

"CONFIDENTIAL," "IMPORTANT," and other stamps that are used often in companies are pre-registered.

1. Open the [printer driver setup window](#)
2. Click **Stamp/Background... (Stamp...)** on the **Page Setup** tab

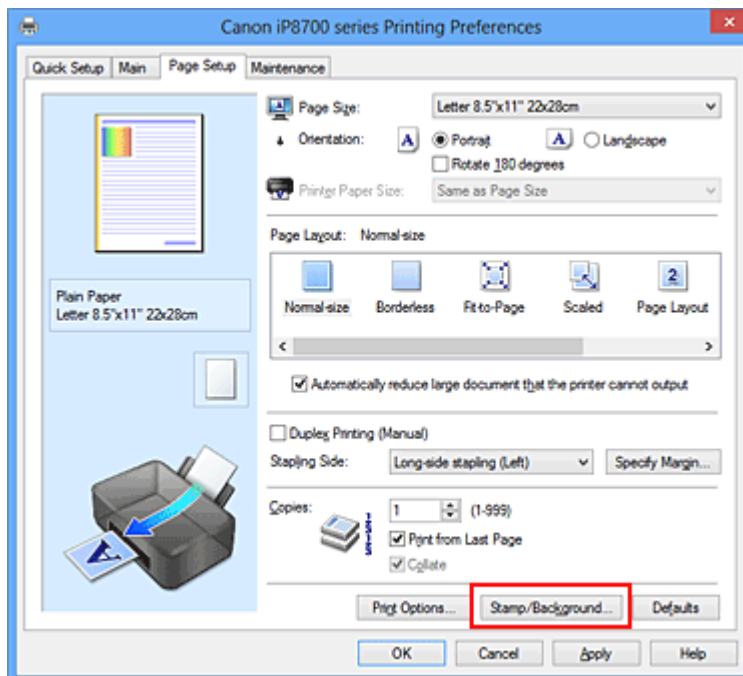

The **Stamp/Background (Stamp)** dialog box opens.

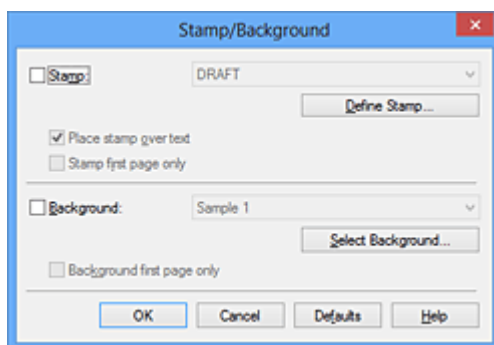

### ➤➤➤ Note

- With the XPS printer driver, the **Stamp/Background...** button has become the **Stamp...** button and only the stamp function can be used.

### 3. Select a stamp

Check the **Stamp** check box, and select the stamp to be used from the list.  
The current settings are displayed in the settings preview on the left side of the **Page Setup** tab.

### 4. Set the stamp details

If necessary, specify the following settings, and then click **OK**.

#### **Define Stamp... button**

To [change the stamp text, bitmap, or position](#), click this.

#### **Place stamp over text**

To print the stamp on the front of the document, check this check box.

#### **»»» Note**

- The stamp is given priority because the stamp is printed over the document data in the sections where the stamp and the document data overlap. When this check box is unchecked, the stamp is printed behind the document data and may be hidden in the overlapping sections depending on the application software used.
- **Place stamp over text** cannot be used when the XPS printer driver is used.  
When the XPS printer driver is used, the stamp is normally printed in the foreground of the document.

#### **Print semitransparent stamp**

Check this check box to print a semi-transparent stamp on the document.  
This function is available only when the XPS printer driver is used.

#### **Stamp first page only**

To print the stamp only on the first page, check this check box.

### 5. Complete the setup

Click **OK** on the **Page Setup** tab.  
When you execute print, the data is printed with the specified stamp.

## Printing a Background

Two bitmap files are pre-registered as samples.

1. Open the [printer driver setup window](#)
2. Click **Stamp/Background...** on the **Page Setup** tab

The **Stamp/Background** dialog box opens.

### 3. Select the background

Check the **Background** check box, and select the background to be used from the list.  
The current settings are displayed in the settings preview on the left side of the **Page Setup** tab.

### 4. Set the background details

If necessary, complete the following settings, and then click **OK**.

### Select Background... button

To [use another background or change the layout or density of a background](#), click this.

### Background first page only

To print the background only on the first page, check this check box.

## 5. Complete the setup

Click **OK** on the **Page Setup** tab.

When you execute print, the data is printed with the specified background.

### ►► Important

- When **Borderless** is selected, the **Stamp/Background... (Stamp...)** button appears grayed out and is unavailable.

### ►► Note

- The stamp and background are not printed on blank sheets inserted with the **Insert blank page** function of booklet printing.

## Related Topics

- ➔ [Registering a Stamp](#)
- ➔ [Registering Image Data to be Used as a Background](#)

# Registering a Stamp

This feature may be unavailable when certain printer drivers or operating environments are used.

You can create and register a new stamp. You can also change and re-register some of the settings of an existing stamp. Unnecessary stamps can be deleted at any time.

The procedure for registering a new stamp is as follows:

## Registering a New Stamp

1. Open the [printer driver setup window](#)
2. Click **Stamp/Background... (Stamp...)** on the **Page Setup** tab

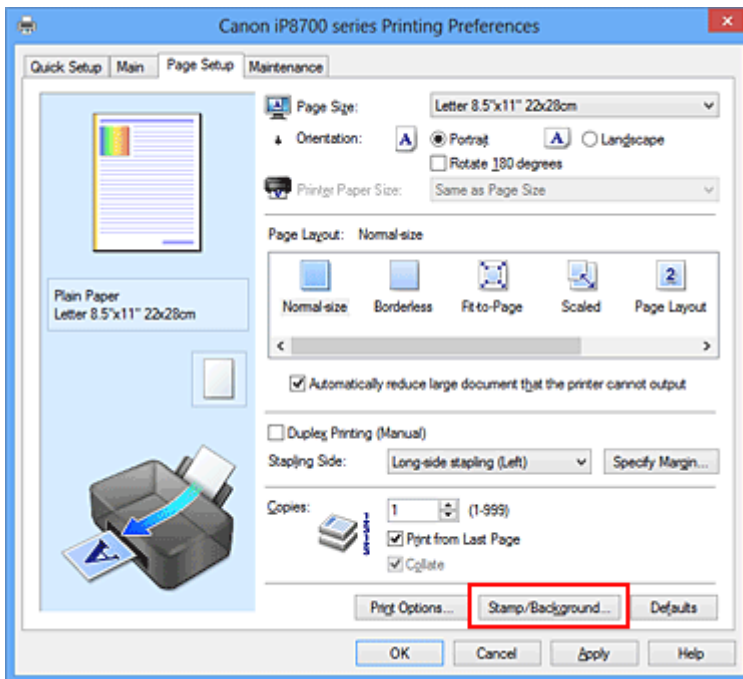

The **Stamp/Background (Stamp)** dialog box opens.

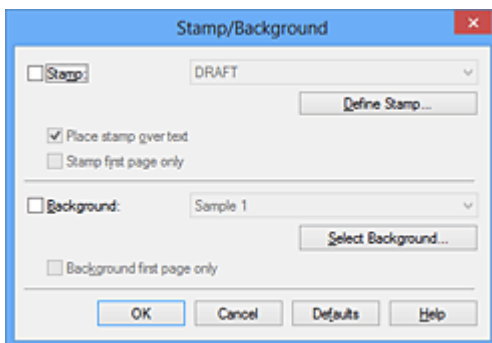

### ➤➤➤ Note

- With the XPS printer driver, the **Stamp/Background...** button has become the **Stamp...** button and only the stamp function can be used.

3. Click **Define Stamp...**

The **Stamp Settings** dialog box opens.

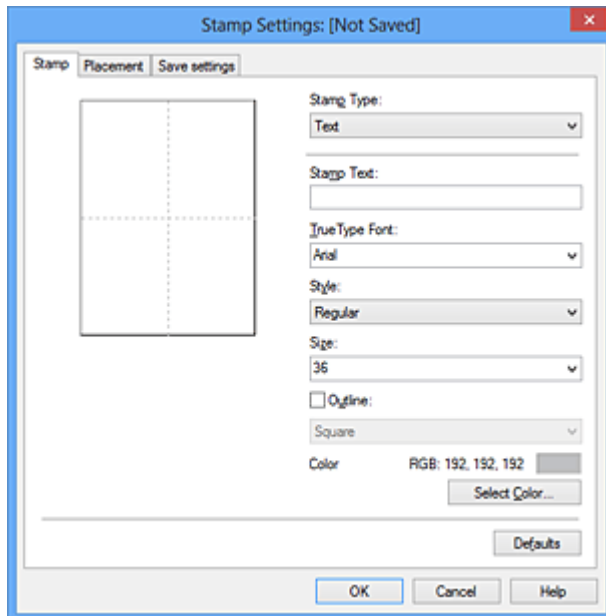

#### 4. Configure the stamp while viewing the preview window

- **Stamp tab**

Select **Text**, **Bitmap**, or **Date/Time/User Name** that matches your purpose for **Stamp Type**.

- For **Text** registration, the characters must already be entered in **Stamp Text**. If necessary, change the **TrueType Font**, **Style**, **Size**, and **Outline** settings. You can select the color of the stamp by clicking **Select Color...**
- For **Bitmap**, click **Select File...** and select the bitmap file (.bmp) to be used. If necessary, change the settings of the **Size** and **Transparent white area**.
- For **Date/Time/User Name**, the creation date/time and user name of the printed object are displayed in **Stamp Text**. If necessary, change the settings of **TrueType Font**, **Style**, **Size**, and **Outline**. You can select the color of the stamp by clicking **Select Color...**

#### »»» Important

- **Stamp Text** appears grayed out and is unavailable when **Date/Time/User Name** is selected.

- **Placement tab**

Select the stamp position from the **Position** list. You can also select **Custom** from the **Position** list and specify coordinates for **X-Position** and **Y-Position**.

You can also change the stamp position by dragging the stamp in the preview window.

To change the stamp position angle, type a value in the **Orientation** box directly.

#### »»» Important

- **Orientation** cannot be changed when **Bitmap** is selected for **Stamp Type** on the **Stamp** tab.

#### 5. Save the stamp

Click the **Save settings** tab and enter a title in the **Title** box, and then click **Save**.

Click **OK** when the confirmation message appears.

#### »»» Note

- Spaces, tabs, and returns cannot be entered at the beginning or end of a title.

## 6. Complete the setup

Click **OK**. The **Stamp/Background (Stamp)** dialog box opens again.  
The registered title appears in the **Stamp** list.

## Changing and Registering Some of Stamp Settings

### 1. Select the stamp for which the settings are to be changed

Select the **Stamp** check box in the **Stamp/Background (Stamp)** dialog box. Then from the list, select the title of the stamp to be changed.

### 2. Click **Define Stamp...**

The **Stamp Settings** dialog box opens.

### 3. Configure the stamp while viewing the preview window

### 4. Overwrite save the stamp

Click **Save overwrite** on the **Save settings** tab.

When you want to save the stamp with a different title, type a new title in the **Title** box and click **Save**.  
Click **OK** when the confirmation message appears.

### 5. Complete the setup

Click **OK**. The **Stamp/Background (Stamp)** dialog box opens again.  
The registered title appears in the **Stamp** list.

## Deleting an Unnecessary Stamp

### 1. Click **Define Stamp...** in the **Stamp/Background (Stamp)** dialog box

The **Stamp Settings** dialog box opens.

### 2. Select the stamp to be deleted

Select the title of the stamp you want to delete from the **Stamps** list on the **Save settings** tab. Then click **Delete**.

Click **OK** when the confirmation message appears.

### 3. Complete the setup

Click **OK**. The **Stamp/Background (Stamp)** dialog box opens again.

# Registering Image Data to be Used as a Background

This feature may be unavailable when certain printer drivers or operating environments are used.

You can select a bitmap file (.bmp) and register it as a new background. You can also change and register some of the settings of an existing background. An unnecessary background can be deleted.

The procedure for registering image data to be used as a background is as follows:

## Registering New Background

1. Open the [printer driver setup window](#)
2. Click **Stamp/Background...** on the **Page Setup** tab

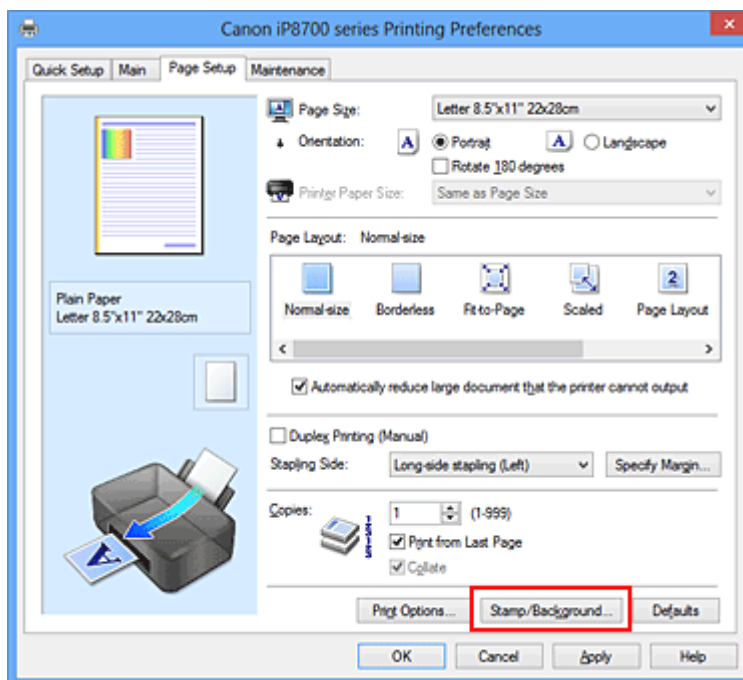

The **Stamp/Background** dialog box opens.

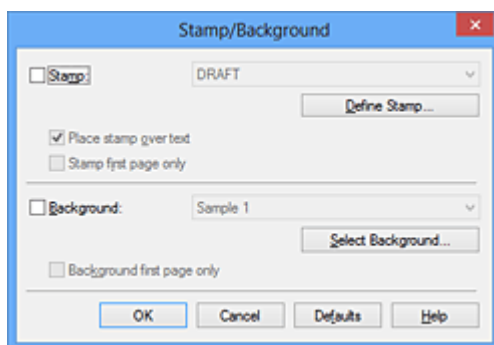

### ➤➤➤ Note

- With the XPS printer driver, the **Stamp/Background...** button has become the **Stamp...** button and **Background** cannot be used.

3. Click **Select Background...**

The **Background Settings** dialog box opens.

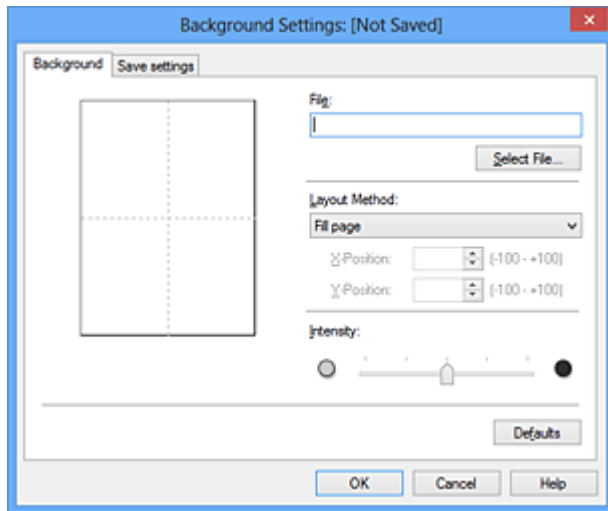

4. Select the image data to be registered to the background

Click **Select File....** Select the target bitmap file (.bmp), and then click **Open**.

5. Specify the following settings while viewing the preview window

#### Layout Method

Select how the background image data is to be placed.

When **Custom** is selected, you can set coordinates for **X-Position** and **Y-Position**.

You can also change the background position by dragging the image in the preview window.

#### Intensity

Set the intensity of the background image data with the **Intensity** slider. Moving the slider to the right darkens the background, and moving the slider to the left lightens the background. To print the background at the original bitmap intensity, move the slider to the rightmost position.

6. Save the background

Click the **Save settings** tab and enter a title in the **Title** box, and then click **Save**.

Click **OK** when the confirmation message appears.

#### ➤➤➤ Note

- Spaces, tabs, and returns cannot be entered at the beginning or end of a title.

7. Complete the setup

Click **OK**, then it returns to **Stamp/Background** dialog box.

The registered title appears in the **Background** list.

## Changing and Registering Some Background Settings

1. Select the background for which the settings are to be changed

Select the **Background** check box in the **Stamp/Background** dialog box. Then from the list, select the title of the background you want to change.

2. Click **Select Background...**



The **Background Settings** dialog box opens.

3. Specify each item on the **Background** tab while viewing the preview window

4. Save the background

Click **Save overwrite** on the **Save settings** tab. When you want to save the background with a different title, enter a new title in the **Title** box and click **Save**.

Click **OK** when the confirmation message appears.

5. Complete the setup

Click **OK**, then it returns to **Stamp/Background** dialog box.

The registered title appears in the **Background** list.

## Deleting an Unnecessary Background

1. Click **Select Background...** in the **Stamp/Background** dialog box

The **Background Settings** dialog box opens.

2. Select the background to be deleted

Select the title of the background you want to delete from the **Backgrounds** list on the **Save settings** tab, and then click **Delete**.

Click **OK** when the confirmation message appears.

3. Complete the setup

Click **OK**, then it returns to **Stamp/Background** dialog box.

# Setting Up Envelope Printing

The procedure for performing envelope printing is as follows:

1. [Load envelope](#) on the printer
2. Open the [printer driver setup window](#)
3. Select the media type

Select **Envelope** from **Commonly Used Settings** on the **Quick Setup** tab.

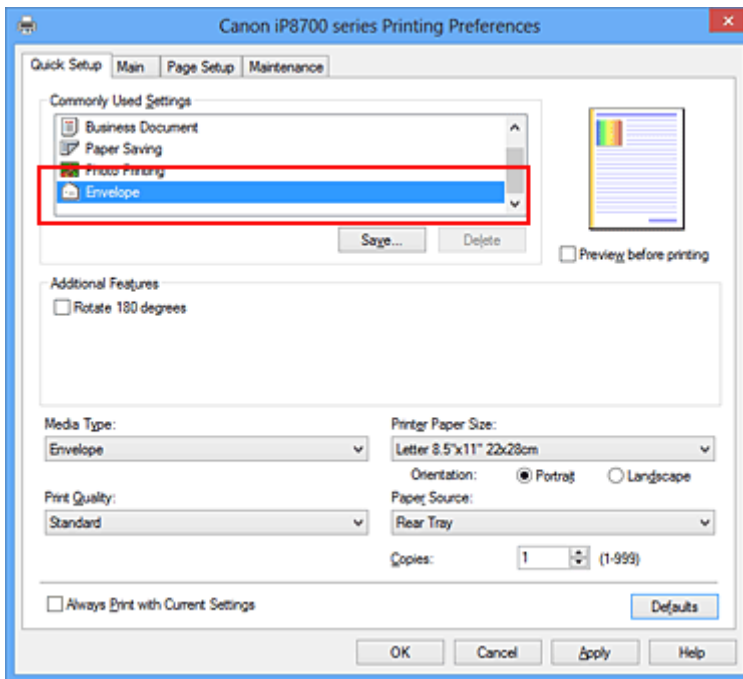

4. Select the paper size

When the **Envelope Size Setting** dialog box is displayed, select **Envelope Com 10**, **Envelope DL**, **Yougata 4 4.13"x9.25"**, or **Yougata 6 3.86"x7.48"**, and then click **OK**.

5. Set the orientation

To print the addressee horizontally, select **Landscape** for **Orientation**.

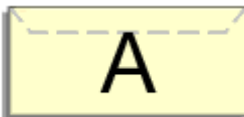

6. Select the print quality

Select **High** or **Standard** that matches your purpose for **Print Quality**.

7. Complete the setup

Click **OK**.

When you execute print, the information is printed on the envelope.

## **»» Important**

- When you execute envelope printing, guide messages are displayed.  
To hide the guide messages, check the **Do not show this message again** check box.  
To show the guide again, click the **View Printer Status** button on the **Maintenance** tab, and start the Canon IJ Status Monitor.  
Then click **Envelope Printing** from **Display Guide Message** of the **Option** menu to enable the setting.

# Printing on Postcards

This section describes the procedure for postcard printing.

1. [Load postcard](#) on the printer
2. Open the [printer driver setup window](#)
3. Select commonly used settings
4. Select the media type

Display the **Quick Setup** tab, and for **Commonly Used Settings**, select **Standard**.

For **Media Type**, select **Hagaki A**, **Ink Jet Hagaki**, **Hagaki K**, or **Hagaki**.

## ▶▶▶ Important

- This printer cannot print on postcards that have photos or stickers attached.
- When printing on each side of a postcard separately, you will get cleaner printing if you print the message side first and then print the address side.

5. Select the paper size

For **Printer Paper Size**, select **Hagaki 100x148mm** or **Hagaki 2 200x148mm**.

## ▶▶▶ Important

- Return postcards can be used only when you print them from the computer.
- When printing a return postcard, always set the paper size to **Hagaki 2 200x148mm** from your application software or the printer driver.
- Do not fold the return postcard. If a crease is formed, the printer will not be able to feed the postcard properly, and this condition will cause line shifts or a paper jam.
- With return postcards, borderless printing cannot be used.

6. Set the print orientation

To print the address horizontally, set **Orientation** to **Landscape**.

7. Select the print quality

For **Print Quality**, select **High** or **Standard**, whichever best suits the purpose.

8. Complete the setup

Click **OK**.

When you execute printing, the data will be printed onto the postcard.

## ▶▶▶ Important

- When you execute postcard printing, a guide message is displayed. When the guide message is displayed, select **Do not show this message again** if you do not want any guide messages to be displayed. To display guide messages again, open the **Maintenance** tab and click **View Printer Status** to start the

Canon IJ Status Monitor.

On the **Option** menu, choose **Display Guide Message** and click **Hagaki Printing** to enable the setting.

- When printing on media other than postcards, load the media according to usage method of that media, and click **Start Printing**.

# Displaying the Print Results before Printing

If you are using the XPS printer driver, replace "Canon IJ Preview" with "Canon IJ XPS Preview" when reading this information.

You can display and check the print result before printing.

The procedure for displaying the print result before printing is as follows:

You can also set the print results display on the **Quick Setup** tab.

1. Open the [printer driver setup window](#)
2. Set the preview

Check the **Preview before printing** check box on the **Main** tab.

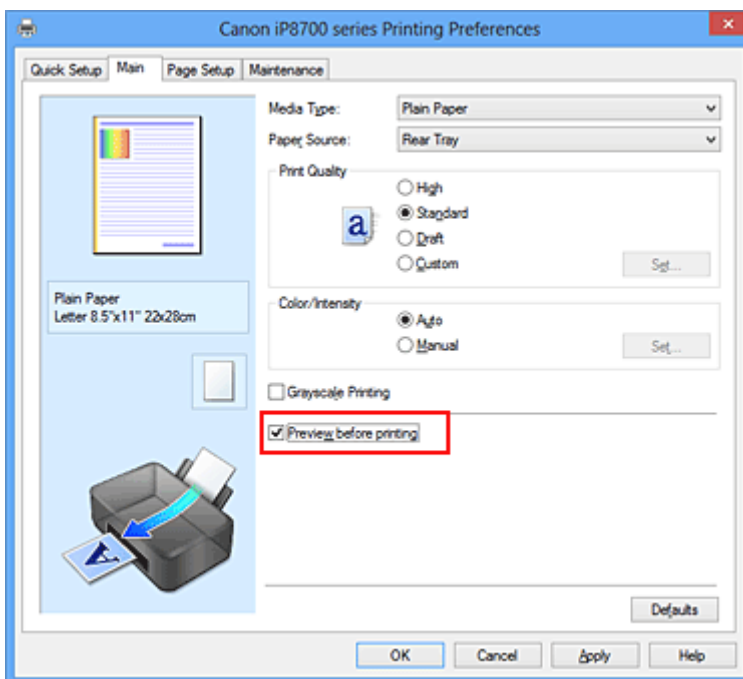

3. Complete the setup

Click **OK**.

When you execute print, the Canon IJ Preview opens and displays the print results.

## ►► Important

- In the **Manual Color Adjustment** dialog box, the **Color Adjustment** tab contains the **Print a pattern for color adjustment** check box. When this check box is selected, the **Preview before printing** appears grayed out and is unavailable.

## Related Topic

➔ [Canon IJ Preview](#)

## Setting Paper Dimensions (Custom Size)

You can specify the height and width of paper when its size cannot be selected from the **Page Size**. Such a paper size is called "custom size."

The procedure for specifying a custom size is as follows:

You can also set a custom size in **Printer Paper Size** on the **Quick Setup** tab.

1. Open the [printer driver setup window](#)
2. Select the paper size

Select **Custom...** for **Page Size** on the **Page Setup** tab.

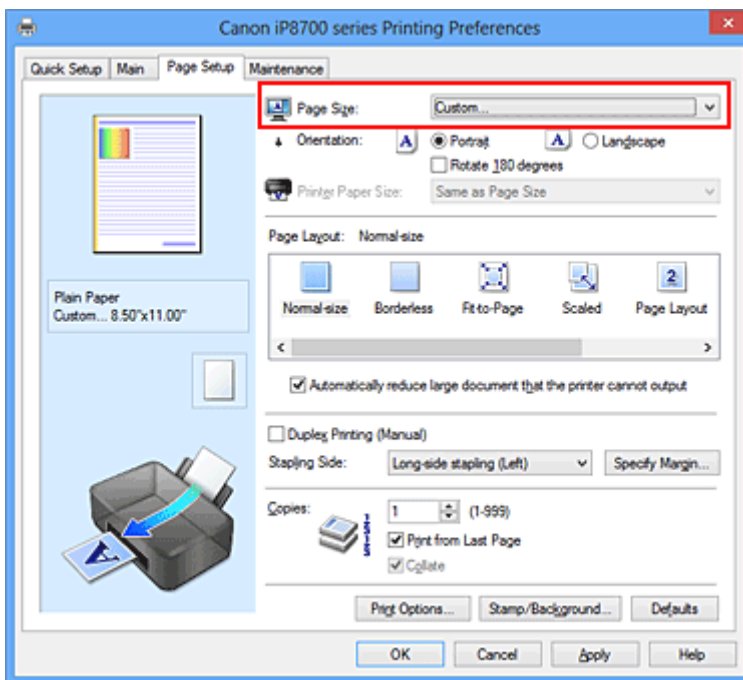

The **Custom Paper Size** dialog box opens.

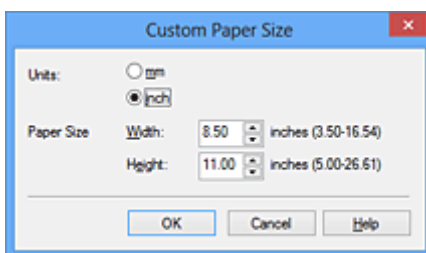

3. Set the custom paper size

Specify **Units**, and enter the **Width** and **Height** of the paper to be used. Then click **OK**.

4. Complete the setup

Click **OK** on the **Page Setup** tab.

When you execute print, the data is printed with the specified paper size.

## **»» Important**

- When the application software that created the document has a function for specifying the height and width values, use the application software to set the values. When the application software does not have such a function or if the document does not print correctly, use the printer driver to set the values.
- Printing may be disabled depending on the size of the specified user-defined media.  
For information about printable sizes for user-defined media, see "[Media Types You Can Use](#)."



# Editing the Print Document or Reprinting from the Print History

This function is unavailable when the standard IJ printer driver is used.

In the Canon IJ XPS preview window, you can edit the print document or retrieve the document print history to print the document.

The procedure for using the Canon IJ XPS Preview is as follows:

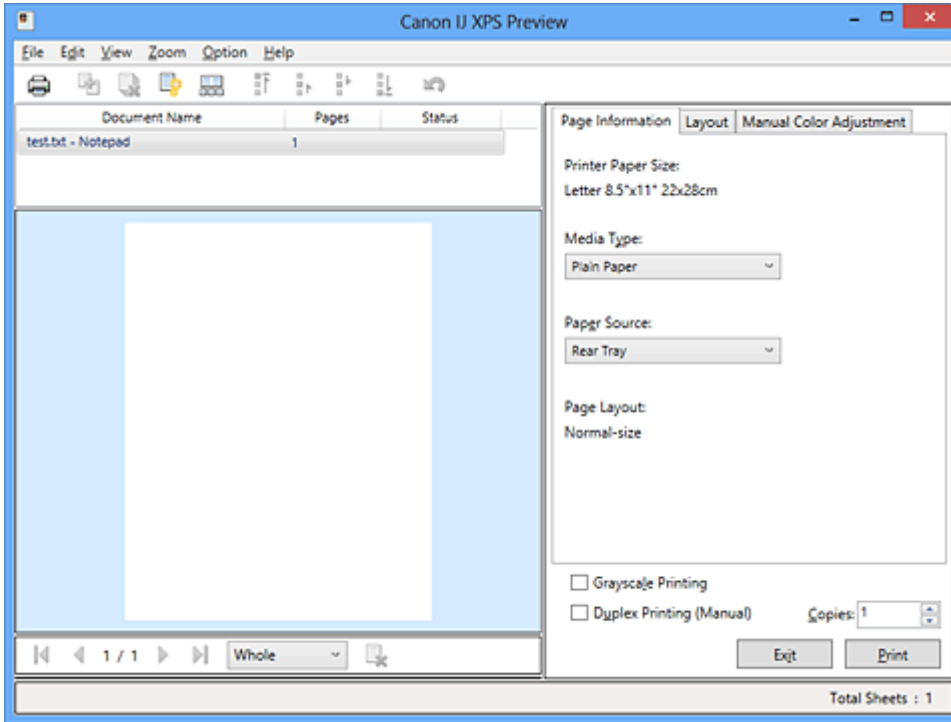

**Print**



**Combine Documents**



**Delete Document**



**Reset Documents**



**View Thumbnails**



**Move Document**



**Undo**





**Move Page**



**Delete Page**

## ➤➤➤ Note

- By clicking  **View Thumbnails**, you can display or hide thumbnails of the print documents selected in the **Document Name** list.
- Clicking  **Undo** reverses the change that just performed.

## Editing and Printing a Print Document

When printing multiple documents or pages, you can combine documents, change the print sequence of the documents or pages, or delete documents or pages.

1. Open the [printer driver setup window](#)

2. Set the preview

Check the **Preview before printing** check box on the **Main** tab.

3. Complete the setup

Click **OK**.

The Canon IJ XPS Preview will start and the print result will be displayed before printing.

4. Editing print documents and print pages

- Combining print documents

You can combine multiple print documents to form a single document. By combining print documents, you can prevent blank pages from being inserted when you execute duplex printing or page layout printing.

From the **Document Name** list, select the documents to be combined. On the **Edit** menu, select **Combine Documents** from **Documents** to combine the documents in the listed sequence.

To select multiple print documents, hold down the Ctrl key and click the documents to be merged, or hold down the Shift key and press the upper arrow or lower arrow key. You can also click a blank area in the document list and drag the mouse to select multiple documents.

When you combine documents, the documents selected before the combining are deleted from the list and the combined document is added to the list.

- Changing the sequence of print documents or print pages

- To change the sequence of the print documents, go to the **Document Name** list, and select the print document to be moved. Next, on the **Edit** menu, select **Move Document** from **Documents**, and select the appropriate item. You can also click and drag a print document to change the print sequence.

- To change the sequence of the print pages, click **View Thumbnails** from the **Option** menu, and select the print page to be moved. Next, on the **Edit** menu, select **Move Page** from **Pages**, and select the appropriate item. You can also click and drag a print page to change the print sequence.

- Deleting print documents and print pages

- To delete a print document, select the target document from the **Document Name** list, and on the **Edit** menu, choose **Documents** and then **Delete Document**.

- To delete a print page, click **View Thumbnails** from the **Option** menu, and select the print page to be deleted. Next, on the **Edit** menu, select **Delete Page** from **Pages**.

- Print page recovery

You can recover pages that were deleted with **Delete Page**.

To recover pages, select the **View Deleted Pages** check box from the **Option** menu, and select the pages to be recovered from among the displayed thumbnail pages. Then from the **Edit** menu chose **Pages** and then **Restore Page**.

After editing the print documents or print pages, you can change the print settings on the **Page Information**, **Layout** and **Manual Color Adjustment** tabs as necessary.

### ▶▶▶ Important

- To display the multiple documents in the list, open the preview and execute print again.
- To return the print documents to their original condition before they were edited in the preview, on the **Edit** menu, select **Reset Documents** from **Documents**.
- If the documents to be combined have different print settings, a message may be displayed. Check the contents of the displayed message before combining the documents.
- If the documents to be combined have different output paper sizes and duplex printing or page layout printing is to be performed, the printer may not produce the expected print results for certain print pages. Check the preview before printing.
- Depending on the print settings of the print document, some functions may not be available in the Canon IJ XPS preview.

### ▶▶▶ Note

- You can rename **Document Name** to any name.

## 5. Executing print

Click **Print**.

When you execute print, the printer uses the specified settings to print the data.

## Reprinting from the Print History

When you click **Save Print History** on the **File** menu to enable the setting, the document printed from the preview is saved, and you can reprint the document with the same settings.

### 1. Displaying the print history

Open the [printer driver setup window](#). Then on the **Maintenance** tab, select **View Print History**. The saved print document is displayed in the preview.

### ▶▶▶ Important

- To limit the number of print history registrations, click **History Entry Limit** on the **File** menu.
- If the limit on the number of registration is exceeded, the print history registrations are deleted starting from the oldest one.

### 2. Selecting a print document

From the **Document Name** list, select the document to be printed.

### 3. Executing print

Click **Print**.

## Related Topic

➔ [Displaying the Print Results before Printing](#)

## Changing the Print Quality and Correcting Image Data

- ➔ [Setting the Print Quality Level \(Custom\)](#)
- ➔ [Printing a Color Document in Monochrome](#)
- ➔ [Adjusting Tone](#)
- ➔ [Specifying Color Correction](#)
- ➔ [Optimal Photo Printing of Image Data](#)
- ➔ [Adjusting Colors with the Printer Driver](#)
- ➔ [Printing with ICC Profiles](#)
- ➔ [Interpreting the ICC Profile](#)
- ➔ [Adjusting Color Balance](#)
- ➔ [Adjusting Color Balance Using Sample Patterns \(Printer Driver\)](#)
- ➔ [Adjusting Brightness](#)
- ➔ [Adjusting Intensity](#)
- ➔ [Adjusting Contrast](#)
- ➔ [Adjusting Intensity/Contrast Using Sample Patterns \(Printer Driver\)](#)

## Setting the Print Quality Level (Custom)

The print quality level can be set in the **Custom**.

The procedure for setting the print quality level is as follows:

1. Open the [printer driver setup window](#)
2. Select the print quality

On the **Main** tab, select **Custom** for **Print Quality**, and click **Set....**

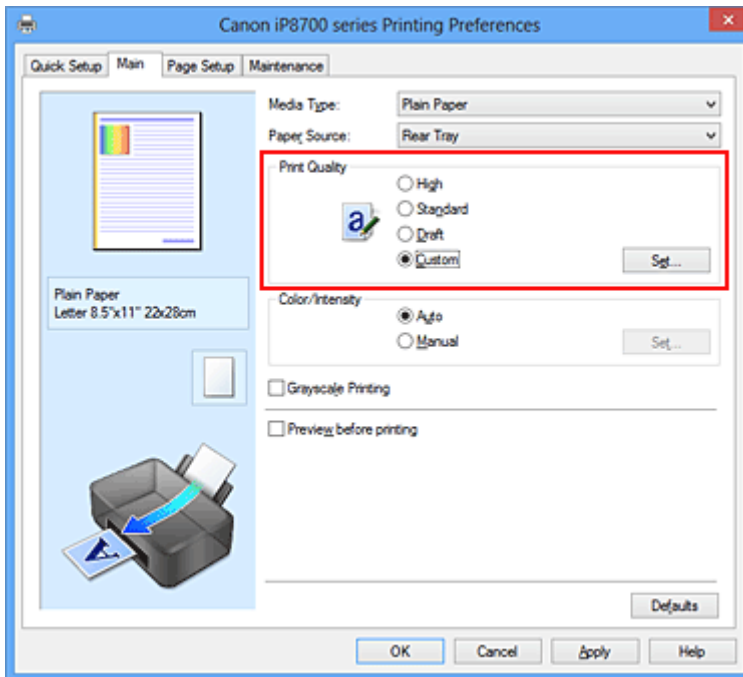

The **Custom** dialog box opens.

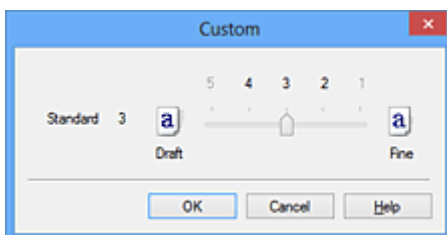

3. Setting the print quality level

Drag the slider bar to select the print quality level and click **OK**.

4. Complete the setup

Click **OK** on the **Main** tab.

When you execute print, the image data is printed with the selected print quality level.

### ►► Important

- Certain print quality levels cannot be selected depending on the settings of **Media Type**.

## Related Topics

- ➔ [Specifying Color Correction](#)
- ➔ [Adjusting Color Balance](#)
- ➔ [Adjusting Brightness](#)
- ➔ [Adjusting Intensity](#)
- ➔ [Adjusting Contrast](#)

# Printing a Color Document in Monochrome

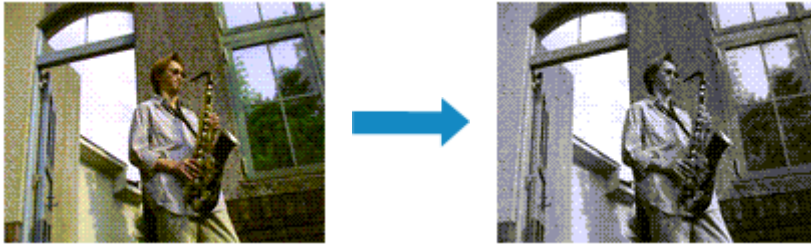

The procedure for printing a color document in monochrome is as follows:

You can also set a grayscale printing in **Additional Features** on the **Quick Setup** tab.

1. Open the [printer driver setup window](#)
2. Set grayscale printing

Check the **Grayscale Printing** check box on the **Main** tab.

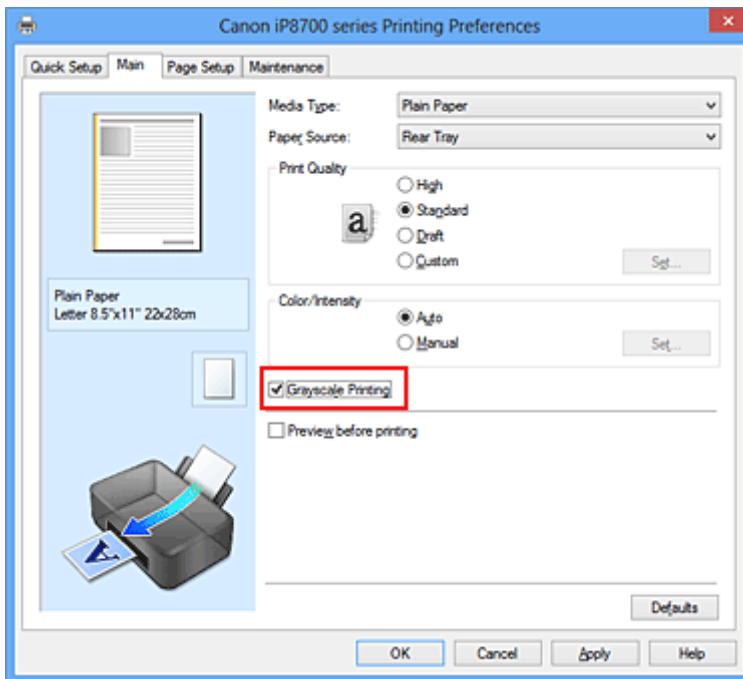

3. Complete the setup

Click **OK**.

When you execute print, the document is converted to grayscale data. It allows you to print the color document in monochrome.

## ▶▶▶ Important

- When the **Grayscale Printing** check box is checked, the printer driver processes image data as sRGB data. In this case, actual colors printed may differ from those in the original image data. When using the grayscale printing function to print Adobe RGB data, convert the data to sRGB data using an application software.

## »» Note

- During **Grayscale Printing**, inks other than black ink may be used as well.

## Related Topic

➔ [Adjusting Tone](#)



# Adjusting Tone

When printing black and white photos, you can produce the cooling effects of cool colors and the warming effects of warm colors.



Cool is selected

Standard is selected

Warm is selected

The procedure for adjusting tone is as follows:

1. Open the [printer driver setup window](#)

2. Select the media type

For **Media Type** on the **Main** tab, select **Photo Paper Plus Glossy II**, **Photo Paper Pro Platinum**, **Photo Paper Pro Luster**, **Photo Paper Plus Semi-gloss** or **Other Fine Art Paper**.

3. Set grayscale printing

Check the **Grayscale Printing** check box.

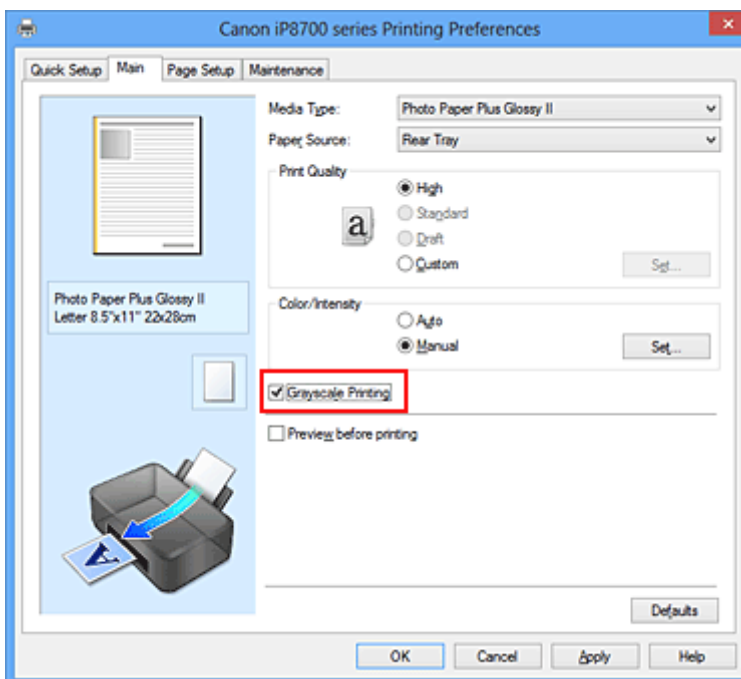

4. Select the manual color adjustment

Select **Manual** for **Color/Intensity**, and click **Set...**

The **Manual Color Adjustment** dialog box opens.

5. Adjusting monochrome tones

Moving the **Tone** slider to the right brings out the warm colors (warm tones), and moving it to the left brings out the cool colors (cool tones).

You can also directly enter a value linked to the slider. Enter a value in the range from -50 to 50.

After adjusting the tones, click **OK**.

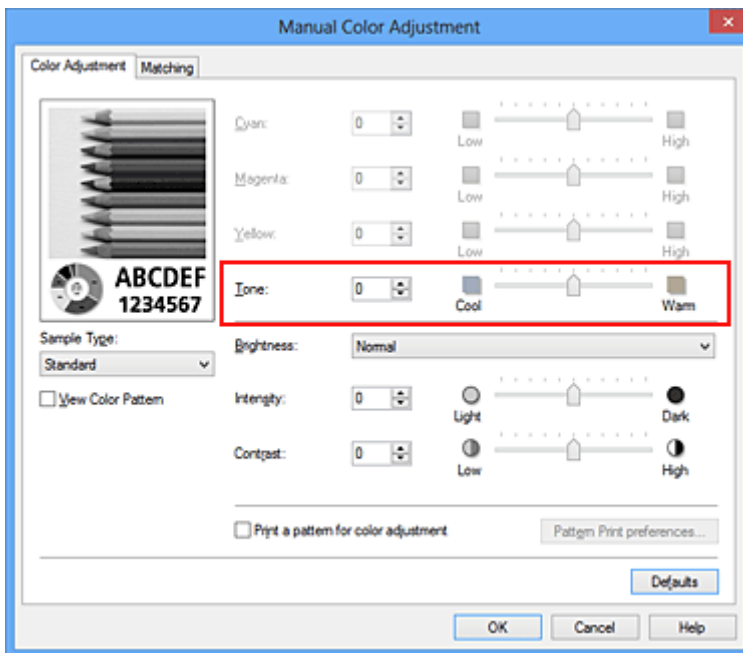

## 6. Complete the setup

Click **OK** on the **Main** tab.

When you execute print, the color document is converted to grayscale data with adjusted tones. It allows you to print the color document in monochrome.

## Related Topics

- ➔ [Printing a Color Document in Monochrome](#)
- ➔ [Adjusting Brightness](#)
- ➔ [Adjusting Intensity](#)
- ➔ [Adjusting Contrast](#)

## Specifying Color Correction

You can specify the color correction method suited to the type of document to be printed.

Normally, the printer driver adjusts the colors by using Canon Digital Photo Color so that data is printed with color tints that most people prefer. This method is suitable for printing sRGB data.

When you want to print by using the color space (Adobe RGB or sRGB) of the image data effectively, select **ICM (ICC Profile Matching)**. When you want to use an application software to specify a printing ICC profile, select **None**.

The procedure for specifying color correction is as follows:

You can also set color correction on the **Quick Setup** tab by choosing **Photo Printing** under **Commonly Used Settings**, and then choosing **Color/Intensity Manual Adjustment** under **Additional Features**.

1. Open the [printer driver setup window](#)
2. Select the manual color adjustment

On the **Main** tab, select **Manual** for **Color/Intensity**, and click **Set...**

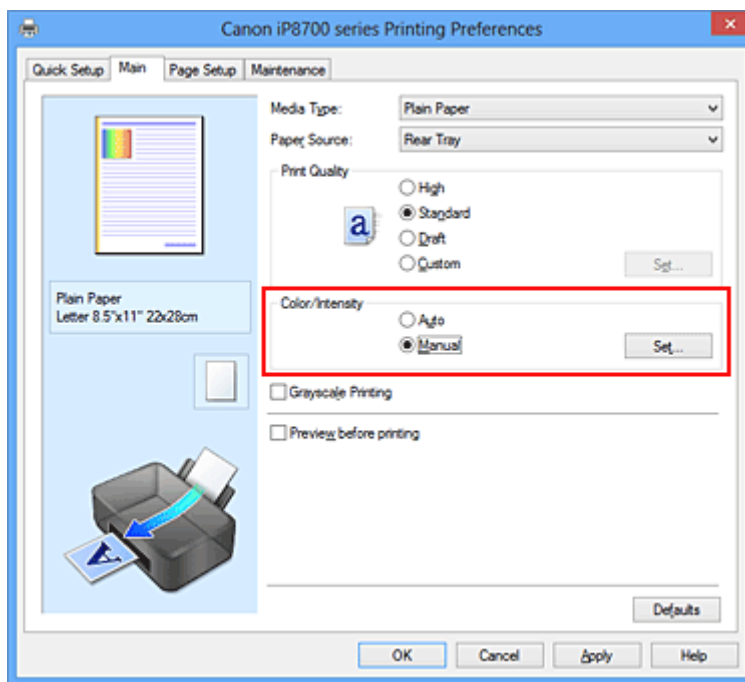

The **Manual Color Adjustment** dialog box opens.

3. Select color correction

Click **Matching** tab, select **Color Correction** setting that matches your purpose from the following, and click **OK**.

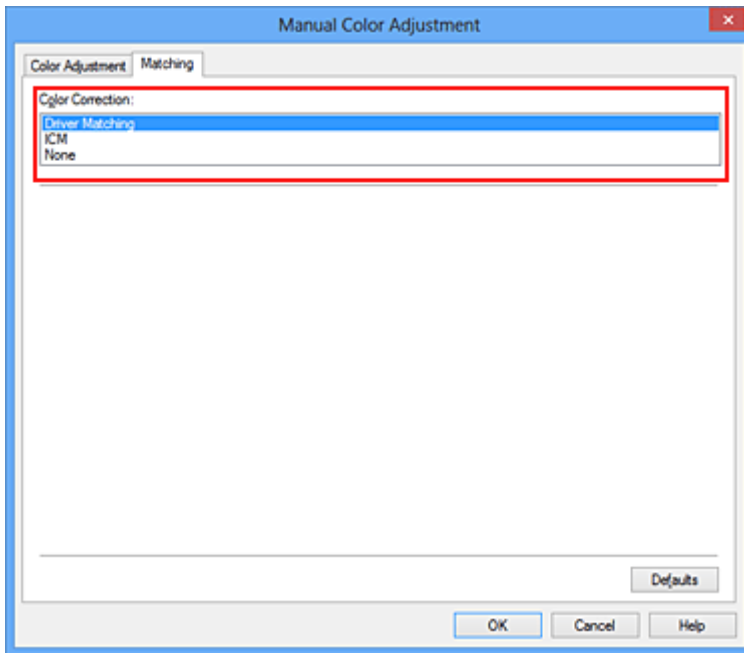

### Driver Matching

With Canon Digital Photo Color, you can print sRGB data with color tints that most people prefer.

### ICM (ICC Profile Matching)

Adjusts the colors by using an ICC profile when printing.  
Specify the input profile or rendering intent to be used.

### None

The printer driver does not perform color correction. Select this value when you are specifying an individually created printing ICC profile or a printing ICC profile for special Canon paper in an application software to print data.

## 4. Complete the setup

Click **OK** on the **Main** tab.

When you execute print, the document data is printed with the specified color correction.

### ▶▶▶ Important

- When ICM is disabled in the application software, **ICM** is unavailable for **Color Correction** and the printer may not be able to print the image data properly.
- When the **Grayscale Printing** check box on the **Main** tab is checked, **Color Correction** appears grayed out and is unavailable.

## Related Topics

- ➔ [Optimal Photo Printing of Image Data](#)
- ➔ [Adjusting Colors with the Printer Driver](#)
- ➔ [Printing with ICC Profiles](#)
- ➔ [Interpreting the ICC Profile](#)

# Optimal Photo Printing of Image Data

When people print images taken with digital cameras, they sometimes feel that the printed color tones differ from those of actual image or those displayed on the monitor.

To get the print results as close as possible to the desired color tones, you must select a printing method that is best suited to the application software used or to your purpose.

## Color Management

Devices such as digital cameras, scanners, monitors, and printers handle color differently. Color management (color matching) is a method that manages device-dependent "colors" as a common color space.

For Windows, a color management system called "ICM" is built into the operating system.

Adobe RGB and sRGB are popularly used as common color spaces. Adobe RGB has a wider color space than sRGB.

ICC profiles convert device-dependent "colors" into a common color space. By using an ICC profile and carrying out color management, you can draw out the color space of the image data within the color reproduction area that the printer can express.

## Selecting a Printing Method Suited to the Image Data

The recommended printing method depends on the color space (Adobe RGB or sRGB) of the image data or the application software to be used.

There are two typical printing methods.

Check the color space (Adobe RGB or sRGB) of the image data and the application software to be used, and then select the printing method suited to your purpose.

### [Adjusting Colors with the Printer Driver](#)

Describes the procedure for printing sRGB data by using the color correction function of the printer driver.

- To print using Canon Digital Photo Color

The printer prints data with color tints that most people prefer, reproducing colors of the original image data and producing three-dimensional effects and high, sharp contrasts.

- To print by directly applying editing and touch-up results of an application software

When printing the data, the printer brings out subtle color difference between dark and light areas, while leaving the darkest and lightest areas intact.

When printing the data, the printer applies fine adjustment results, such as brightness adjustments made with an application software.

### [Printing with ICC Profiles](#)

Describes the procedure for printing by using the color space of Adobe RGB or sRGB effectively.

You can print with a common color space by setting up the application software and the printer driver so that the color management matches the input ICC profile of the image data.

The method for setting up the printer driver differs depending on the application software to be used.

## Related Topic

- ➔ [Interpreting the ICC Profile](#)

# Adjusting Colors with the Printer Driver

You can specify the color correction function of the printer driver to print sRGB data with color tints that most people prefer through the use of Canon Digital Photo Color.

When printing from an application software that can identify ICC profiles and allows you to specify them, use a printing ICC profile in the application software, and select settings for color management.

The procedure for adjusting colors with the printer driver is as follows:

1. Open the [printer driver setup window](#)

2. Select the manual color adjustment

On the **Main** tab, select **Manual** for **Color/Intensity**, and click **Set...**

The **Manual Color Adjustment** dialog box opens.

3. Select color correction

Click **Matching** tab, and select **Driver Matching** for **Color Correction**.

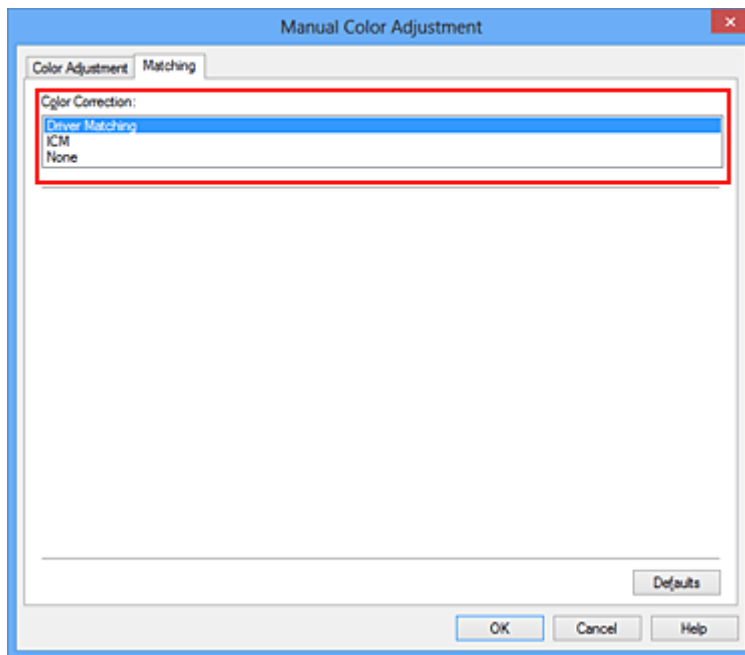

4. Set the other items

If necessary, click **Color Adjustment** tab, and adjust the color balance (**Cyan, Magenta, Yellow**) and adjust **Brightness, Intensity, and Contrast** settings, and then click **OK**.

5. Complete the setup

Click **OK** on the **Main** tab.

When you execute print, the printer driver adjusts the colors when printing the data.

## Related Topics

- ➔ [Setting the Print Quality Level \(Custom\)](#)
- ➔ [Specifying Color Correction](#)
- ➔ [Adjusting Color Balance](#)

- ➔ [Adjusting Brightness](#)
- ➔ [Adjusting Intensity](#)
- ➔ [Adjusting Contrast](#)

# Printing with ICC Profiles

When the image data has a specified input ICC profile, you can print by using the color space (Adobe RGB or sRGB) of the data effectively.

The printer driver setting procedure varies depending on the application software used to print.

## Specify an ICC Profile from the Application Software and Print the Data

When you print the editing and touch-up results of Adobe Photoshop, Canon Digital Photo Professional, or any application software that allows you to specify input and printing ICC profiles, you print by effectively using the color space of the input ICC profile specified in the image data.

To use this printing method, use your application software to select color management items and specify an input ICC profile and a printing ICC profile in the image data.

Even if you print using a printing ICC profile that you created yourself or one for special Canon paper, be sure to select color management items from your application software.

For instructions, refer to the manual of the application software you are using.

1. Open the [printer driver setup window](#)
2. Select the manual color adjustment

On the **Main** tab, select **Manual** for **Color/Intensity**, and click **Set...**  
The **Manual Color Adjustment** dialog box opens.

3. Select color correction

Click **Matching** tab, and select **None** for **Color Correction**.

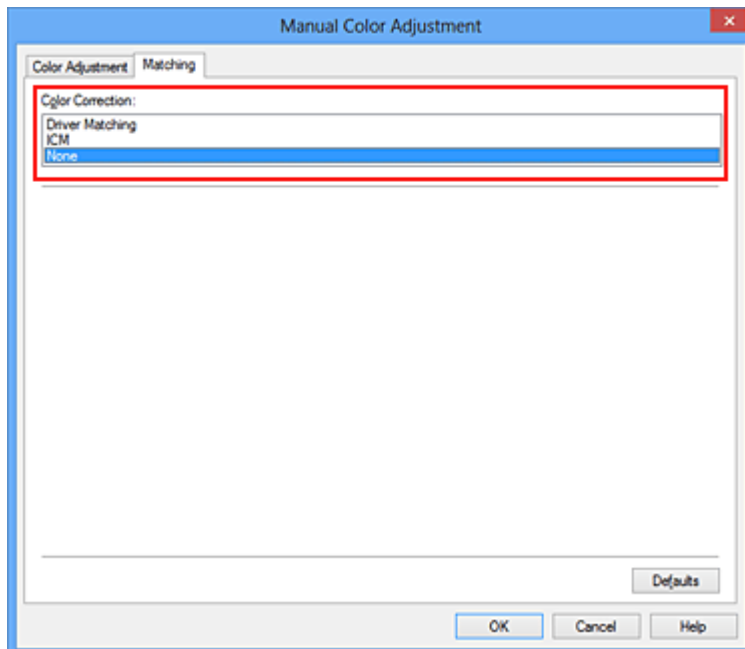

4. Set the other items

If necessary, click **Color Adjustment** tab, and adjust the color balance (**Cyan, Magenta, Yellow**) and adjust **Brightness, Intensity, and Contrast** settings, and then click **OK**.



## 5. Complete the setup

Click **OK** on the **Main** tab.

When you execute print, the printer uses the color space of the image data.

## Specify an ICC Profile with the Printer Driver, and then Print

Print from an application software that cannot identify input ICC profiles or does allow you to specify one by using the color space of the input ICC profile (sRGB) found in the data. When printing Adobe RGB data, you can print the data with the Adobe RGB color space even if the application software does not support Adobe RGB.

### 1. Open the [printer driver setup window](#)

### 2. Select the manual color adjustment

On the **Main** tab, select **Manual** for **Color/Intensity**, and click **Set...**

The **Manual Color Adjustment** dialog box opens.

### 3. Select color correction

Click **Matching** tab, and select **ICM (ICC Profile Matching)** for **Color Correction**.

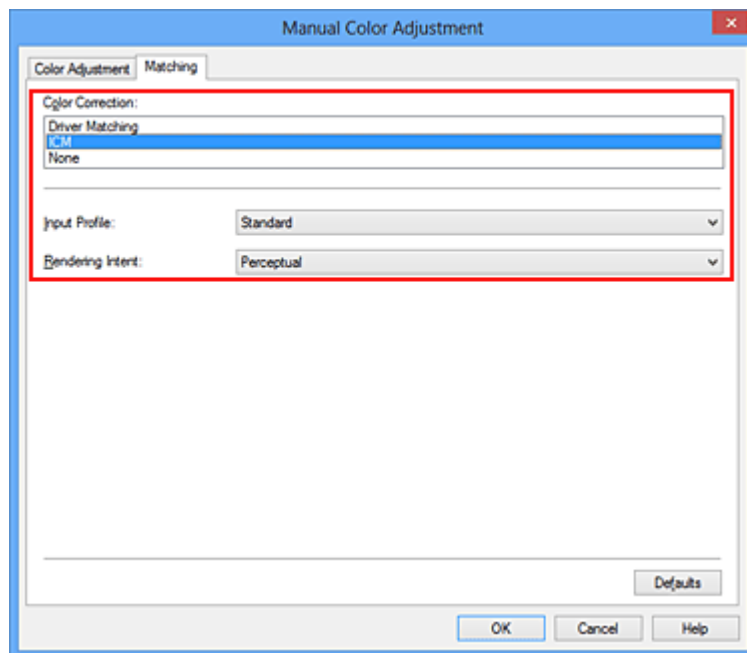

### 4. Select the input profile

Select an **Input Profile** that matches the color space of the image data.

- For sRGB data or data without an input ICC profile:

Select **Standard**.

- For Adobe RGB data:

Select **Adobe RGB (1998)**.

## »» Important

- When the application software specifies an input profile, the input profile setting of the printer driver becomes invalid.
- When no input ICC profiles are installed on your computer, **Adobe RGB (1998)** will not be displayed.

### 5. Select the rendering intent

Select the coloring adjustment method in **Rendering Intent**.

- **Saturation**

This method reproduces images even more vividly than the **Perceptual** method.

- **Perceptual**

This method reproduces images by focusing on color tints that most people prefer. Select this method to print photos.

- **Relative Colorimetric**

When image data is converted to the color space of the printer, this method converts the image data so the color reproduction approximates the shared color regions. Select this method to print image data with colors that are close to the original colors.

- **Absolute Colorimetric**

When **Relative Colorimetric** is selected, white spots are reproduced as white spots of the paper (background color). However, when **Absolute Colorimetric** is selected, how the white spots are reproduced depends on the image data.

## »» Important

- When Windows XP SP2 or Windows XP SP3 is used, this function is disabled.

### 6. Set the other items

If necessary, click **Color Adjustment** tab, and adjust the color balance (**Cyan, Magenta, Yellow**) and adjust **Brightness, Intensity, and Contrast** settings, and then click **OK**.

### 7. Complete the setup

Click **OK** on the **Main** tab.

When you execute print, the printer uses the color space of the image data.

## Related Topics

- ➔ [Setting the Print Quality Level \(Custom\)](#)
- ➔ [Specifying Color Correction](#)
- ➔ [Adjusting Color Balance](#)
- ➔ [Adjusting Brightness](#)
- ➔ [Adjusting Intensity](#)
- ➔ [Adjusting Contrast](#)

## Interpreting the ICC Profile

When you need to specify the printer profile, select the ICC profile for the paper to print on.

The ICC profiles installed for this printer appear as follows.

Canon XXXXX PR 1  
(1) (2) (3)

- (1) is the model name of the printer.
- (2) is the media type. This notation corresponds to the following media type:
  - GL: Photo Paper Plus Glossy II
  - PT: Photo Paper Pro Platinum
  - SG/LU: Photo Paper Plus Semi-gloss / Photo Paper Pro Luster
  - MP: Matte Photo Paper
  - Other Fine Art Paper: Other Fine Art Paper
- (3) is the print quality.

The print quality is divided into 5 levels, ranging from high speed to high quality. As the number decreases, the print quality becomes higher. This value corresponds to the slider bar position in the **Custom** dialog box of the printer driver.

# Adjusting Color Balance

You can adjust the color tints when printing.

Since this function adjusts color balance of the output by changing the ink ratios of each color, it changes the total color balance of the document. Use the application software when you want to change the color balance significantly. Use the printer driver only when you want to adjust the color balance slightly.

The following sample shows the case when color balance is used to intensify cyan and to diminish yellow so that the overall colors are more uniform.



No adjustment    Adjust color balance

The procedure for adjusting color balance is as follows:

You can also set color balance on the **Quick Setup** tab by choosing **Photo Printing** under **Commonly Used Settings**, and then choosing **Color/Intensity Manual Adjustment** under **Additional Features**.

1. Open the [printer driver setup window](#)
2. Select the manual color adjustment

On the **Main** tab, select **Manual** for **Color/Intensity**, and click **Set...**

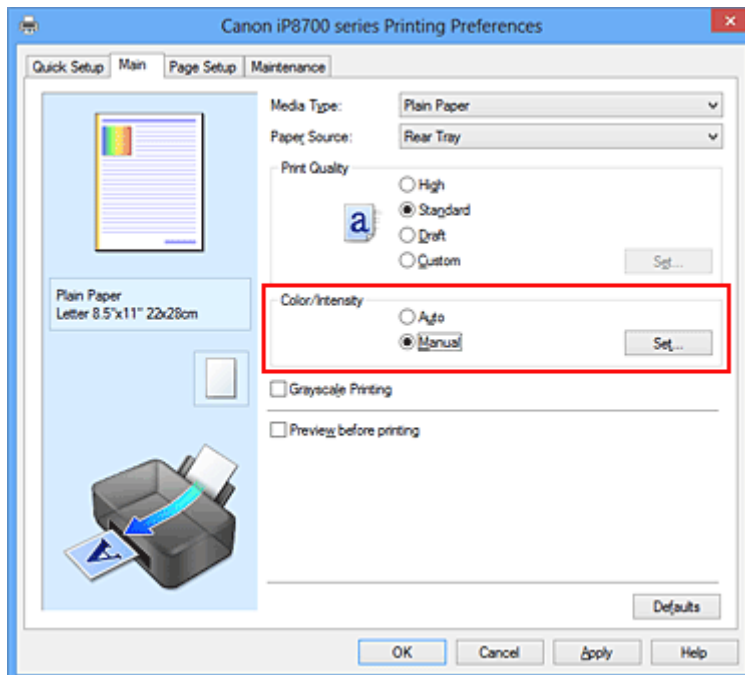

The **Manual Color Adjustment** dialog box opens.

3. Adjust color balance

There are individual sliders for **Cyan**, **Magenta**, and **Yellow**. Each color becomes stronger when the corresponding slider is moved to the right, and becomes weaker when the corresponding slider is moved to the left. For example, when cyan becomes weaker, the color red becomes stronger.

You can also directly enter a value linked to the slider. Enter a value in the range from -50 to 50. The current settings are displayed in the settings preview on the left side of the printer driver.

After adjusting each color, click **OK**.

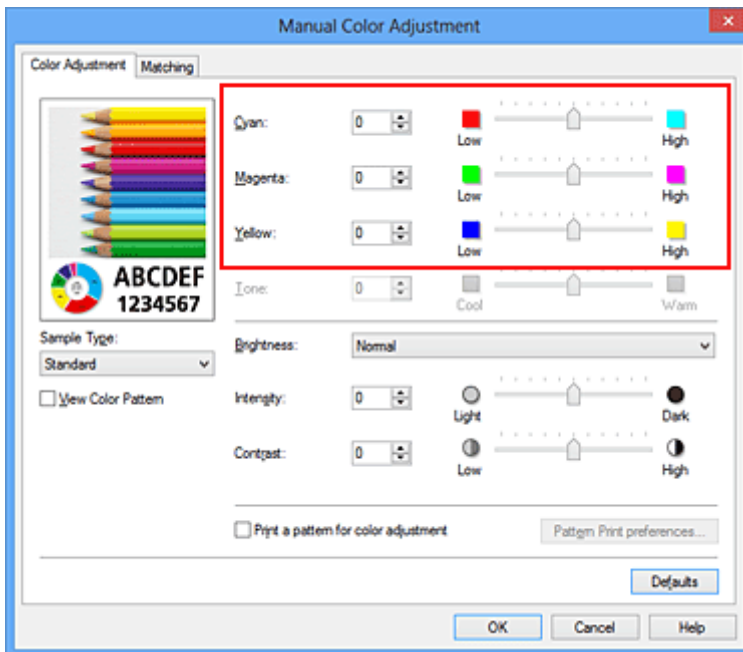

### »»» Important

- Adjust the slider gradually.

#### 4. Complete the setup

Click **OK** on the **Main** tab.

When you execute print, the document is printed with the adjusted color balance.

### »»» Important

- When the **Grayscale Printing** check box on the **Main** tab is checked, the color balance (**Cyan**, **Magenta**, **Yellow**) appear grayed out and are unavailable.

## Related Topics

- ➔ [Setting the Print Quality Level \(Custom\)](#)
- ➔ [Specifying Color Correction](#)
- ➔ [Adjusting Color Balance Using Sample Patterns \(Printer Driver\)](#)
- ➔ [Adjusting Brightness](#)
- ➔ [Adjusting Intensity](#)
- ➔ [Adjusting Contrast](#)
- ➔ [Adjusting Intensity/Contrast Using Sample Patterns \(Printer Driver\)](#)

# Adjusting Color Balance Using Sample Patterns (Printer Driver)

You can look at the print results of pattern print and adjust the color balance.

When you change the color balance or intensity/contrast of a document, the pattern print function prints the adjustment results in a list, together with the adjustment values.

Described below is the procedure for adjusting the color balance while looking at the pattern.

1. Open the [printer driver setup window](#)
2. Select the manual color adjustment

On the **Main** tab, select **Manual** for **Color/Intensity**, and click **Set...**

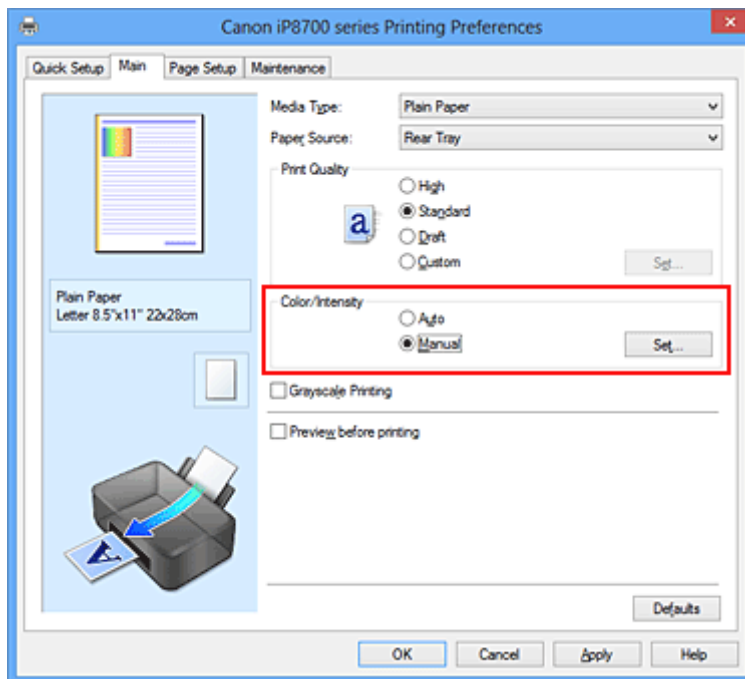

The **Manual Color Adjustment** dialog box opens.

3. Selecting pattern print

On the **Color Adjustment** tab, select the **Print a pattern for color adjustment** check box, and click **Pattern Print preferences...**

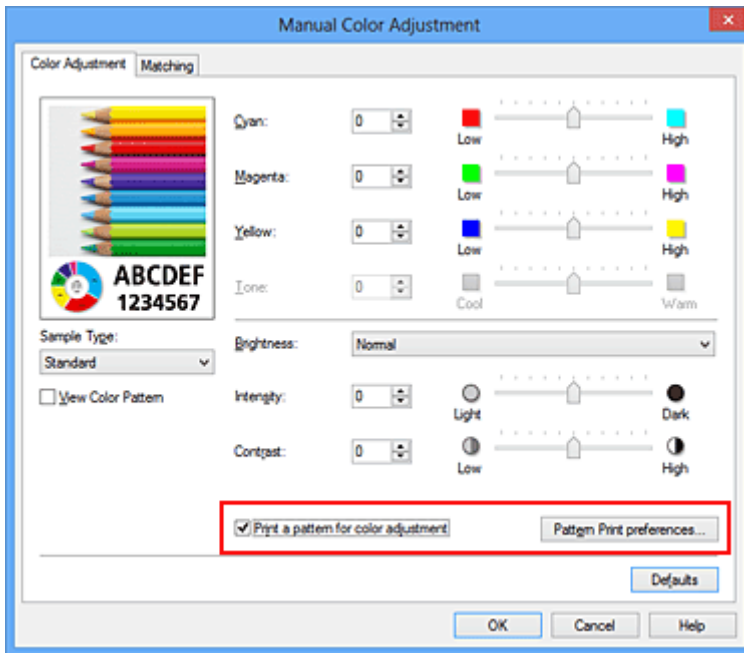

#### 4. Setting pattern print

When the **Pattern Print** dialog box opens, set the following items, and then click **OK**.

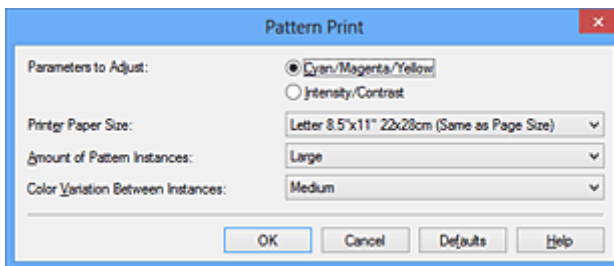

##### Parameters to Adjust

Select **Cyan/Magenta/Yellow**.

##### ►►► Important

- When the **Grayscale Printing** check box on the **Main** tab is checked, **Cyan/Magenta/Yellow** appear grayed out and are unavailable.

##### Printer Paper Size

Select the paper size to be used for pattern printing.

##### ►►► Note

- Depending on the paper size selected on the **Page Setup** tab, there may be sizes that cannot be selected.

##### Amount of Pattern Instances

Select **Largest**, **Large**, or **Small** to set the number of patterns to be printed.

##### ►►► Note

- **Largest** and **Large** cannot be selected when certain paper sizes or output paper sizes are selected.

##### Color Variation Between Instances

Set the amount of color change between neighboring patterns.

►► Note

- **Large** is about double the size of **Medium**, and **Small** is about half the size of **Medium**.

5. Checking the print results of pattern print

On the **Color Adjustment** tab, select **OK** to close the **Manual Color Adjustment** dialog box. On the **Main** tab, select **OK**, and then execute printing. The printer then prints a pattern in which the color balance that you set is the center value.



6. Adjusting the color balance

Look at the print results and select the image that you like best. Then enter the color balance numbers indicated at the bottom of that image into the **Cyan**, **Magenta**, and **Yellow** fields on the **Color Adjustment** tab.

Clear the **Print a pattern for color adjustment** check box, and click **OK**.



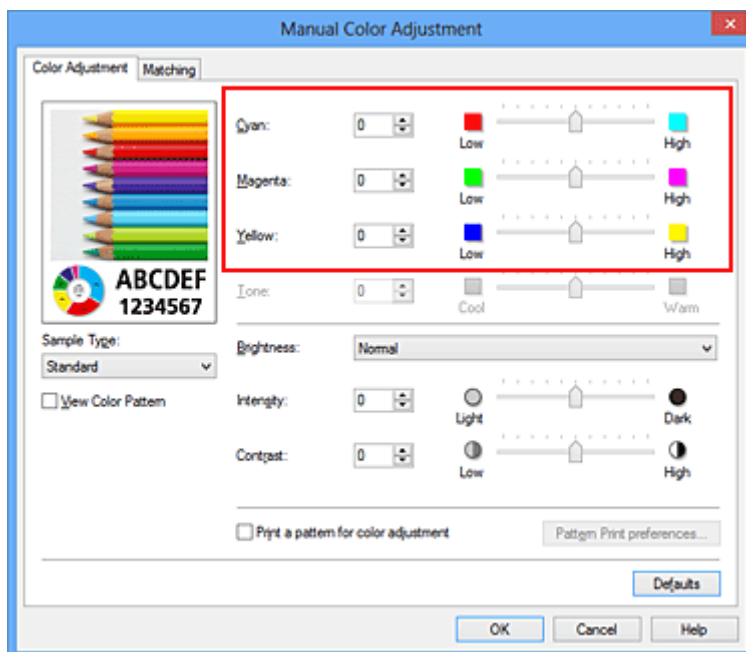

## ►►► Note

- You can also set color balance on the **Quick Setup** tab by choosing **Photo Printing** under **Commonly Used Settings**, and then choosing **Color/Intensity Manual Adjustment** under **Additional Features**.

## 7. Complete the setup

Click **OK** on the **Main** tab.

Then when you execute printing, the document is printed with the color balance that was adjusted by the pattern print function.

## ►►► Important

- When **Print a pattern for color adjustment** is selected on the **Color Adjustment** tab, the following items are grayed out and cannot be set:
  - **Preview before printing** on the **Main** tab
  - **Stapling Side** and **Specify Margin...** on the **Page Setup** tab (When **Duplex Printing (Manual)** is set, only **Stapling Side** can be set.)
- You can print a pattern only if the **Page Layout** setting on the **Page Setup** tab is **Normal-size** or **Borderless**.
- When the **Grayscale Printing** check box on the **Main** tab is checked, **Cyan**, **Magenta**, and **Yellow** appear grayed out and are unavailable.
- Depending on your application software, this function may not be available.

## Related Topics

- ➔ [Adjusting Color Balance](#)
- ➔ [Adjusting Intensity](#)
- ➔ [Adjusting Contrast](#)
- ➔ [Adjusting Intensity/Contrast Using Sample Patterns \(Printer Driver\)](#)

# Adjusting Brightness

You can change the brightness of the overall image data during printing.

This function does not change pure white or pure black but it changes the brightness of the intermediate colors.

The following sample shows the print result when the brightness setting is changed.



Light is selected

Normal is selected

Dark is selected

The procedure for adjusting brightness is as follows:

You can also set brightness on the **Quick Setup** tab by choosing **Photo Printing** under **Commonly Used Settings**, and then choosing **Color/Intensity Manual Adjustment** under **Additional Features**.

1. Open the [printer driver setup window](#)
2. Select the manual color adjustment

On the **Main** tab, select **Manual** for **Color/Intensity**, and click **Set...**

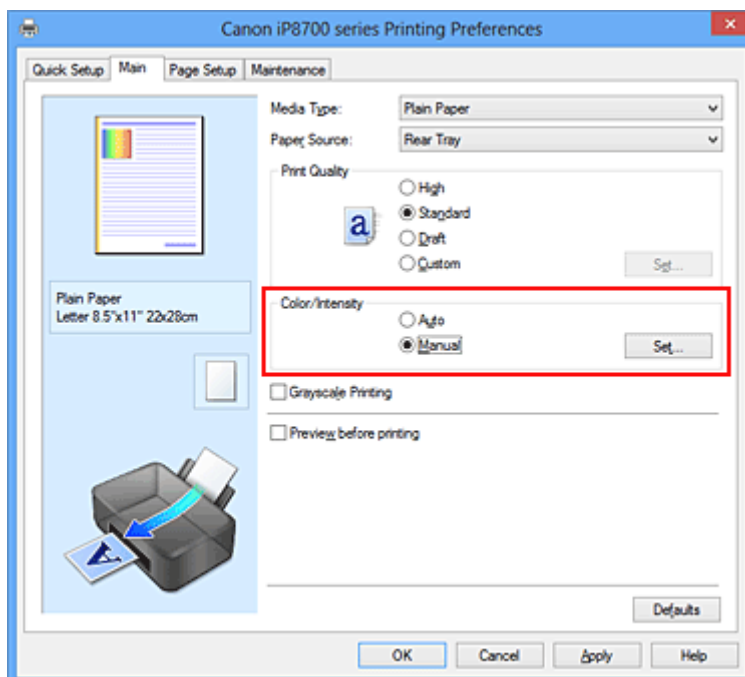

The **Manual Color Adjustment** dialog box opens.

3. Specify the brightness

Select **Light**, **Normal**, or **Dark** for **Brightness**, and click **OK**. The current settings are displayed in the settings preview on the left side of the printer driver.

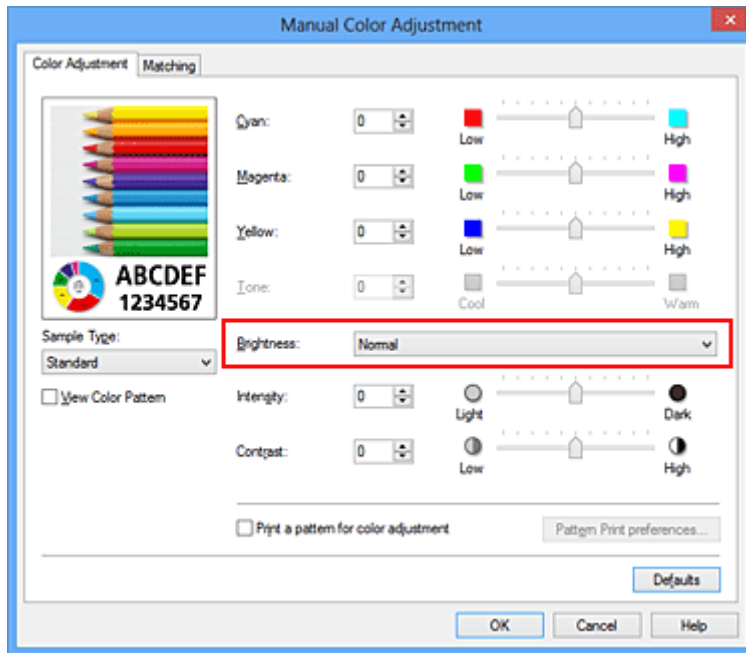

#### 4. Complete the setup

Click **OK** on the **Main** tab.

When you execute print, the data is printed at the specified brightness.

### Related Topics

- ➔ [Setting the Print Quality Level \(Custom\)](#)
- ➔ [Specifying Color Correction](#)
- ➔ [Adjusting Color Balance](#)
- ➔ [Adjusting Intensity](#)
- ➔ [Adjusting Contrast](#)

## Adjusting Intensity

You can dilute (brighten) or intensify (darken) the colors of the overall image data during printing. The following sample shows the case when the intensity is increased so that all colors become more intense when the image data is printed.



No adjustment



Higher intensity

The procedure for adjusting intensity is as follows:

You can also set intensity on the **Quick Setup** tab by choosing **Photo Printing** under **Commonly Used Settings**, and then choosing **Color/Intensity Manual Adjustment** under **Additional Features**.

1. Open the [printer driver setup window](#)
2. Select the manual color adjustment

On the **Main** tab, select **Manual** for **Color/Intensity**, and click **Set...**

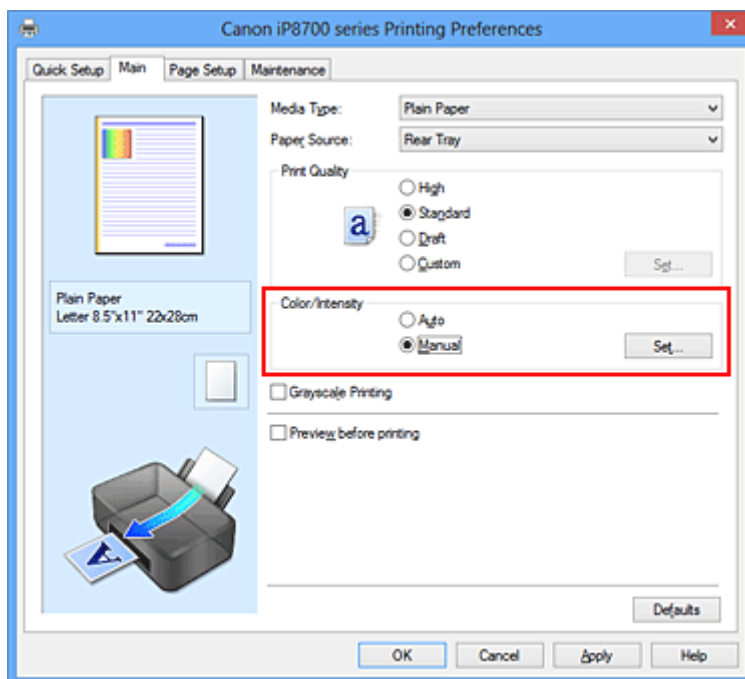

The **Manual Color Adjustment** dialog box opens.

3. Adjust intensity

Moving the **Intensity** slider to the right intensifies (darkens) the colors, and moving the slider to the left dilutes (brightens) the colors.

You can also directly enter a value linked to the slider. Enter a value in the range from -50 to 50. The current settings are displayed in the settings preview on the left side of the printer driver.

After adjusting each color, click **OK**.

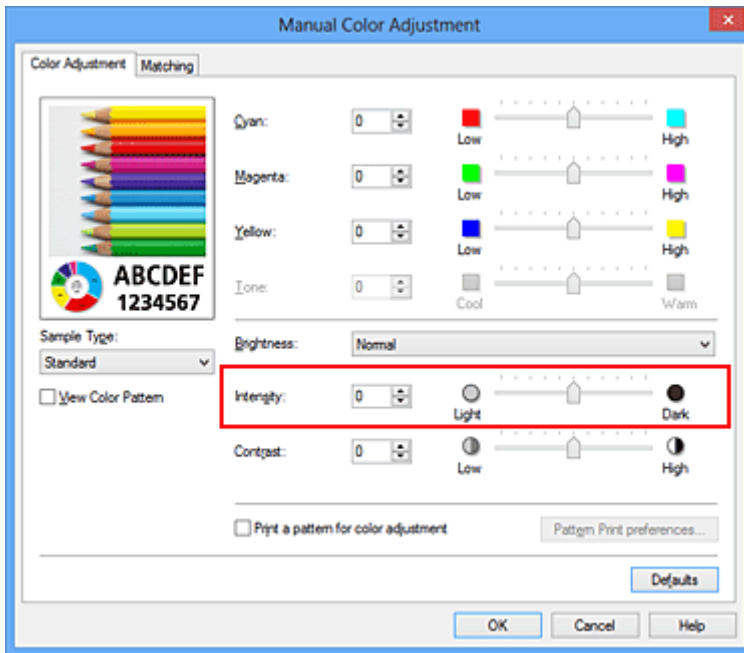

### ►►► Important

- Adjust the slider gradually.

#### 4. Complete the setup

Click **OK** on the **Main** tab.

When you execute print, the image data is printed with the adjusted intensity.

### Related Topics

- ➔ [Setting the Print Quality Level \(Custom\)](#)
- ➔ [Specifying Color Correction](#)
- ➔ [Adjusting Color Balance](#)
- ➔ [Adjusting Color Balance Using Sample Patterns \(Printer Driver\)](#)
- ➔ [Adjusting Brightness](#)
- ➔ [Adjusting Contrast](#)
- ➔ [Adjusting Intensity/Contrast Using Sample Patterns \(Printer Driver\)](#)

# Adjusting Contrast

You can adjust the image contrast during printing.

To make the differences between the light and dark portions of images greater and more distinct, increase the contrast. On the other hand, to make the differences between the light and dark portions of images smaller and less distinct, reduce the contrast.



No adjustment

Adjust the contrast

The procedure for adjusting contrast is as follows:

You can also set contrast on the **Quick Setup** tab by choosing **Photo Printing** under **Commonly Used Settings**, and then choosing **Color/Intensity Manual Adjustment** under **Additional Features**.

1. Open the [printer driver setup window](#)
2. Select the manual color adjustment

On the **Main** tab, select **Manual** for **Color/Intensity**, and click **Set...**

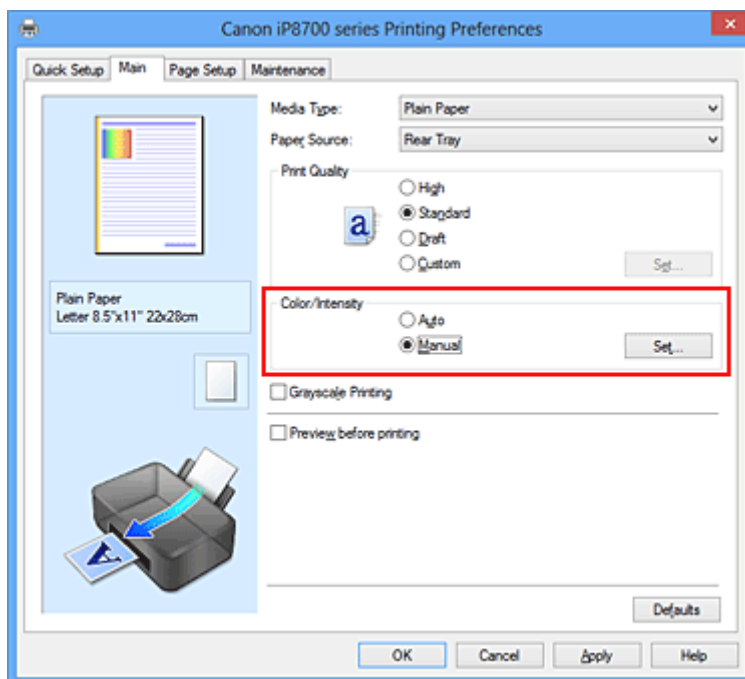

The **Manual Color Adjustment** dialog box opens.

3. Adjust the contrast

Moving the **Contrast** slider to the right increases the contrast, and moving the slider to the left decreases the contrast.

You can also directly enter a value linked to the slider. Enter a value in the range from -50 to 50. The current settings are displayed in the settings preview on the left side of the printer driver.

After adjusting each color, click **OK**.

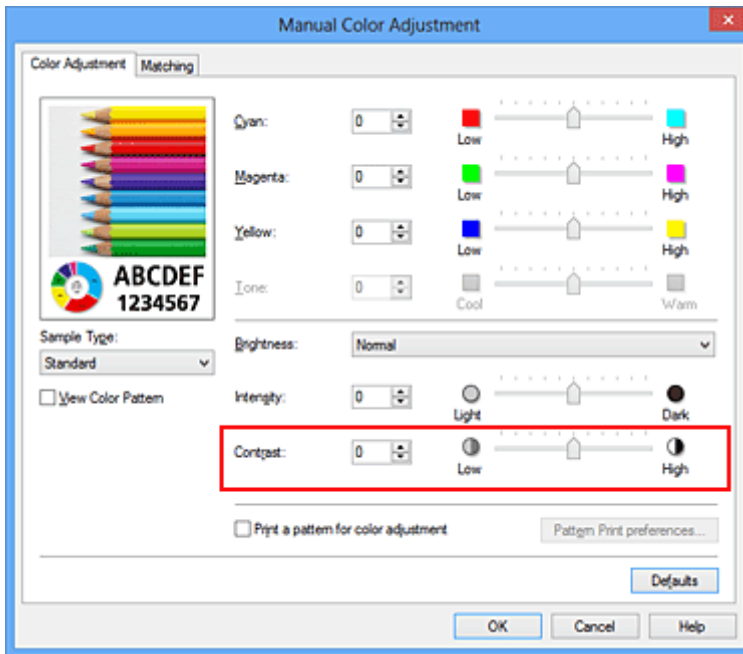

### »»» Important

- Adjust the slider gradually.

#### 4. Complete the setup

Click **OK** on the **Main** tab.

When you execute print, the image is printed with the adjusted contrast.

### Related Topics

- ➔ [Setting the Print Quality Level \(Custom\)](#)
- ➔ [Specifying Color Correction](#)
- ➔ [Adjusting Color Balance](#)
- ➔ [Adjusting Color Balance Using Sample Patterns \(Printer Driver\)](#)
- ➔ [Adjusting Brightness](#)
- ➔ [Adjusting Intensity](#)
- ➔ [Adjusting Intensity/Contrast Using Sample Patterns \(Printer Driver\)](#)

# Adjusting Intensity/Contrast Using Sample Patterns (Printer Driver)

You can look at the print results of pattern print and adjust the intensity/contrast.

When you change the color balance or intensity/contrast of a document, the pattern print function prints the adjustment results in a list, together with the adjustment values.

Described below is the procedure for adjusting the intensity/contrast while looking at the pattern.

1. Open the [printer driver setup window](#)
2. Select the manual color adjustment

On the **Main** tab, select **Manual** for **Color/Intensity**, and click **Set...**

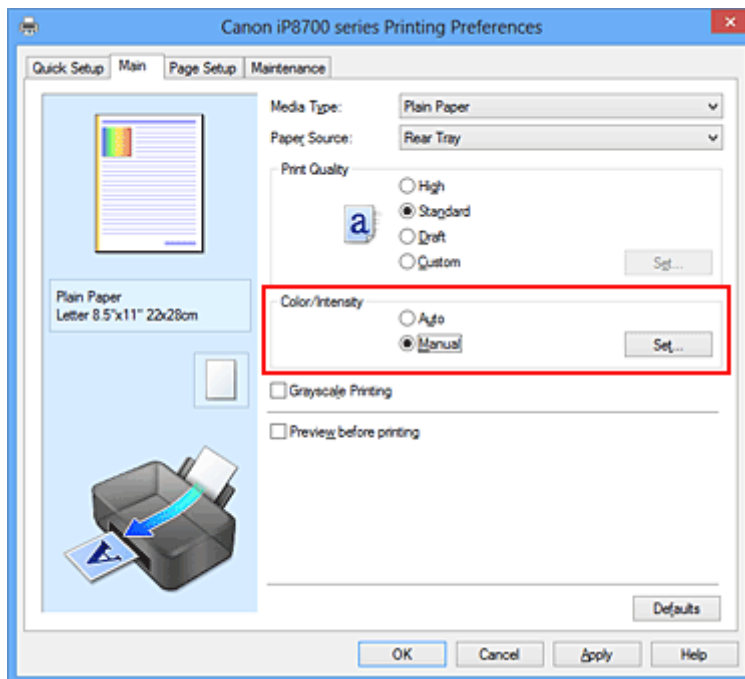

The **Manual Color Adjustment** dialog box opens.

3. Selecting pattern print

On the **Color Adjustment** tab, select the **Print a pattern for color adjustment** check box, and click **Pattern Print preferences...**



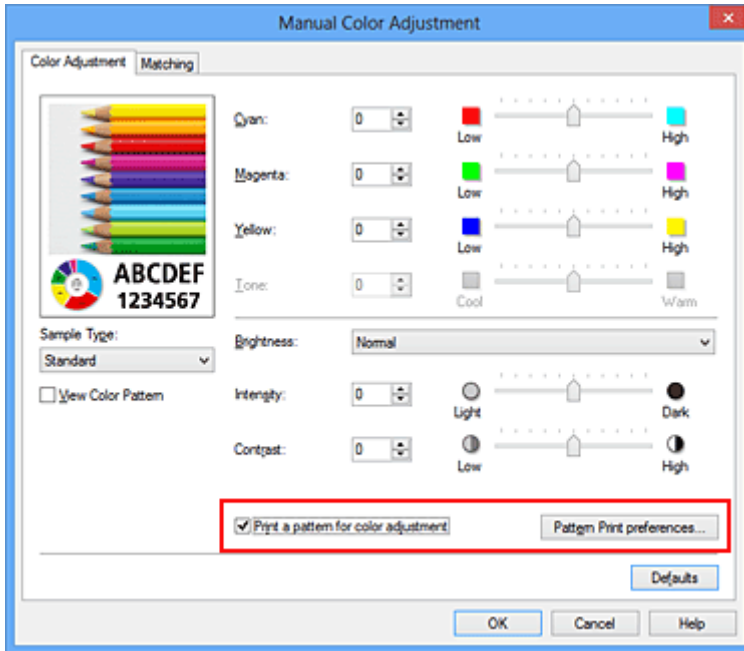

#### 4. Setting pattern print

When the **Pattern Print** dialog box opens, set the following items, and then click **OK**.

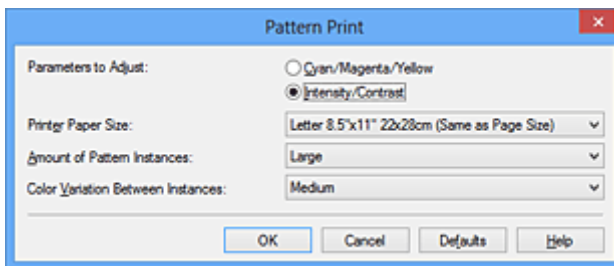

##### Parameters to Adjust

Select **Intensity/Contrast**.

##### Printer Paper Size

Select the paper size to be used for pattern printing.

##### ➤➤➤ Note

- Depending on the paper size selected on the **Page Setup** tab, there may be sizes that cannot be selected.

##### Amount of Pattern Instances

Select **Largest**, **Large**, or **Small** to set the number of patterns to be printed.

##### ➤➤➤ Note

- **Largest** and **Large** cannot be selected when certain paper sizes or output paper sizes are selected.

##### Color Variation Between Instances

Set the amount of color change between neighboring patterns.

##### ➤➤➤ Note

- **Large** is about double the size of **Medium**, and **Small** is about half the size of **Medium**.

#### 5. Checking the print results of pattern print

On the **Color Adjustment** tab, select **OK** to close the **Manual Color Adjustment** dialog box.  
 On the **Main** tab, select **OK**, and then execute printing. The printer then prints a pattern in which the intensity/contrast that you set is the center value.



## 6. Adjusting the intensity/contrast

Look at the print results and select the image that you like best. Then enter the intensity/contrast numbers indicated at the bottom of that image into the **Intensity** and **Contrast** fields on the **Color Adjustment** tab.

Clear the **Print a pattern for color adjustment** check box, and click **OK**.

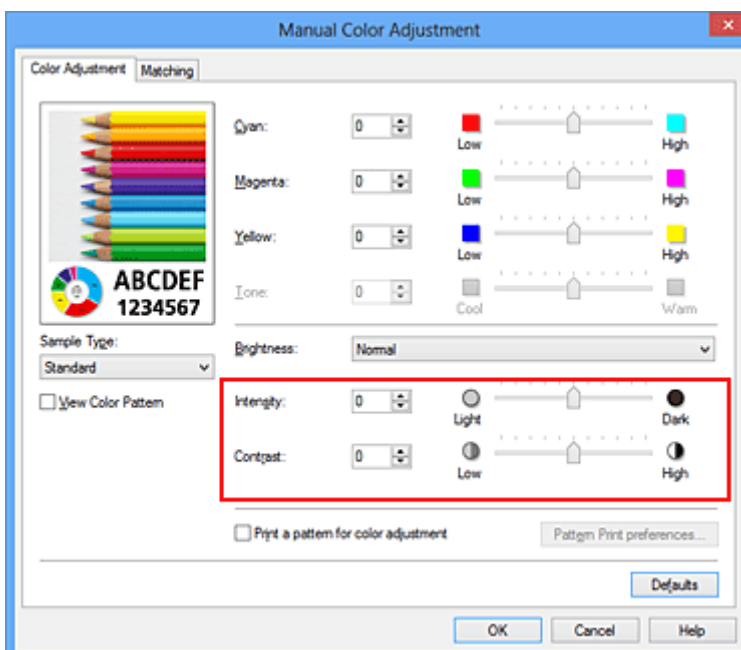

## »» Note

- You can also set intensity/contrast on the **Quick Setup** tab by choosing **Photo Printing** under **Commonly Used Settings**, and then choosing **Color/Intensity Manual Adjustment** under **Additional Features**.

### 7. Complete the setup

Click **OK** on the **Main** tab.

Then when you execute printing, the document is printed with the intensity/contrast that was adjusted by the pattern print function.

## »» Important

- When **Print a pattern for color adjustment** is selected on the **Color Adjustment** tab, the following items are grayed out and cannot be set:
  - **Preview before printing** on the **Main** tab
  - **Stapling Side** and **Specify Margin...** on the **Page Setup** tab (When **Duplex Printing (Manual)** is set, only **Stapling Side** can be set.)
- You can print a pattern only if the **Page Layout** setting on the **Page Setup** tab is **Normal-size** or **Borderless**.
- Depending on your application software, this function may not be available.

## Related Topics

- ➔ [Adjusting Color Balance](#)
- ➔ [Adjusting Color Balance Using Sample Patterns \(Printer Driver\)](#)
- ➔ [Adjusting Intensity](#)
- ➔ [Adjusting Contrast](#)

## Overview of the Printer Driver

- ➔ [Canon IJ Printer Driver](#)
- ➔ [How to Open the Printer Driver Setup Window](#)
- ➔ [Canon IJ Status Monitor](#)
- ➔ [Checking the Ink Status from Your Computer](#)
- ➔ [Canon IJ Preview](#)
- ➔ [Deleting the Undesired Print Job](#)
- ➔ [Instructions for Use \(Printer Driver\)](#)

# Canon IJ Printer Driver

The Canon IJ printer driver (called printer driver below) is a software that is installed on your computer for printing data with this printer.

The printer driver converts the print data created by your application software into data that your printer can understand, and sends the converted data to the printer.

Because different models support different print data formats, you need a printer driver for the specific model you are using.

## Printer Driver Types

On Windows Vista SP1 or later, you can install the XPS printer driver in addition to the regular printer driver.

The XPS printer driver is suited to print from an application software that supports XPS printing.

### ►► Important

- To use the XPS printer driver, the standard printer driver must already be installed on your computer.

## Installing the Printer Driver

- To install the regular printer driver, load the Setup CD-ROM that comes with the printer, and then install the driver from **Start Setup Again**.
- To install the XPS printer driver, load the Setup CD-ROM that comes with the printer, and then select **XPS Driver** from **Add Software**.

## Specifying the Printer Driver

To specify the printer driver, open the **Print** dialog box of the application software you are using, and select "XXX" (where "XXX" is your model name) to specify the regular printer driver or select "XXX XPS" (where "XXX" is your model name) to specify the XPS printer driver.

## Displaying the Manual from the Printer Driver

To display a description of a tab in the printer driver setup window, click the **Help** button found on the tab.

## Related Topic

- ➔ [How to Open the Printer Driver Setup Window](#)

# How to Open the Printer Driver Setup Window

You can display the printer driver setup window from the application software in use or from the printer icon.

## Open the Printer Driver Setup Window through the Application Software

Follow the procedure below to configure printing profile when printing.

1. Select the command that you perform printing on the application software

In general, select **Print** on the **File** menu to open the **Print** dialog box.

2. Select your model name and click **Preferences** (or **Properties**)

The printer driver setup window appears.

### »» Note

- Depending on application software you use, command names or menu names may vary and there may be more steps. For details, refer to the user's manual of your application software.

## Opening the Printer Driver Setup Window from the Printer Icon

Follow the procedure below to perform printer maintenance operations such as print head cleaning, or to configure a printing profile that is common to all application software.

1. Select as described below:

- If you are using Windows 8, from the Desktop charms, select **Settings** -> **Control Panel** -> **Hardware and Sound** -> **Devices and Printers**.
- If you are using Windows 7, select the **Start** menu -> **Devices and Printers**.
- If you are using Windows Vista, select the **Start** menu -> **Control Panel** -> **Hardware and Sound** -> **Printers**.
- If you are using Windows XP, select the **start** menu -> **Control Panel** -> **Printers and Other Hardware** -> **Printers and Faxes**.

2. Right-click your model name icon, and then select **Printing preferences** from the displayed menu

The printer driver setup window appears.

### »» Important

- Opening the printer driver setup window through **Printer properties** (Windows 8, Windows 7) or **Properties** (Windows Vista, Windows XP) displays such tabs regarding the Windows functions as the **Ports** (or **Advanced**) tab. Those tabs do not appear when opening through **Printing preferences** or application software. For tabs regarding Windows functions, refer to the user's manual for the Windows.

# Canon IJ Status Monitor

The Canon IJ Status Monitor is an application software that shows the status of the printer and the progress of printing. You will know the status of the printer with graphics, icons, and messages.

## Launching the Canon IJ Status Monitor

The Canon IJ Status Monitor launches automatically when print data is sent to the printer. When launched, the Canon IJ Status Monitor appears as a button on the task bar.



Click the button of the status monitor displayed on the task bar. The Canon IJ Status Monitor appears.

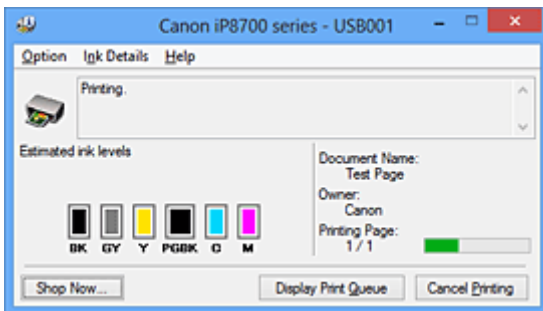

## ►► Note

- To open the Canon IJ Status Monitor when the printer is not printing, open the [printer driver setup window](#) and click **View Printer Status** on the **Maintenance** tab.
- The information displayed on the Canon IJ Status Monitor may differ depending on the country or region where you are using your printer.

## When Errors Occur

The Canon IJ Status Monitor is automatically displayed if an error occurs (e.g., if the printer runs out of paper or if the ink is low).

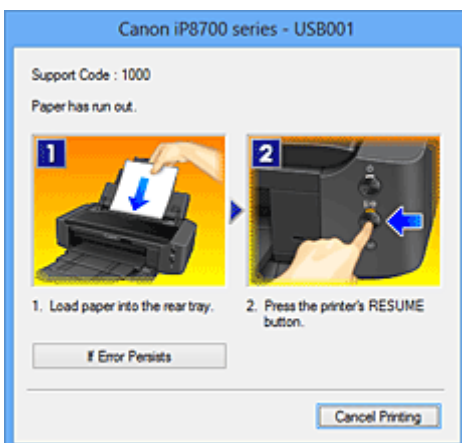

In such cases, take the appropriate action as described.

## Checking the Ink Status from Your Computer

You can check the remaining ink level and the ink tank types for your model.

1. Open the [printer driver setup window](#)
2. Launching the Canon IJ Status Monitor

On the **Maintenance** tab, click **View Printer Status**.

The Canon IJ Status Monitor opens and displays an image of the ink status.

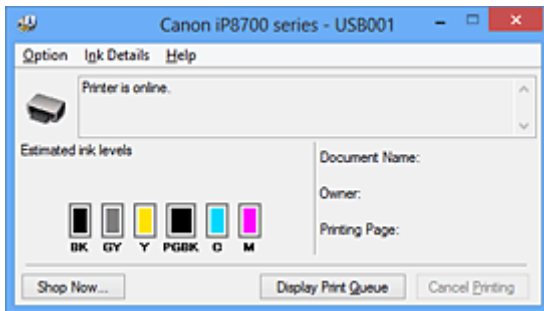

### ►► Note

- The information displayed on the Canon IJ Status Monitor may differ depending on the country or region where you are using your printer.
- When you receive a notice about the remaining ink level, a mark appears above the ink icon.  
For example: 🚨  
Ink tank is running low. Prepare a new ink tank.
- When you print on A3 paper or larger paper sizes, the ink may run out before printing is finished or the printing may become faint or streaky (with white lines).

3. If necessary, click **Ink Details**

You can check the ink-related information.

If a warning or error related to the remaining ink amount occurs, a notification icon is displayed at the top of the image in the **Ink Details** dialog box.

In such cases, take the appropriate action as described on the screen.

### ►► Note

- You can also display the **Ink Details** dialog box by selecting the ink icon on the Canon IJ Status Monitor.



# Canon IJ Preview

The Canon IJ Preview is an application software that displays what the print result will look like before a document is actually printed.

The preview reflects the information that is set within the printer driver and allows you to check the document layout, print order, and number of pages. You can also change the media type settings.

When you want to display a preview before printing, open the [printer driver setup window](#), click the **Main** tab, and check the **Preview before printing** check box.

When you do not want to display a preview before printing, uncheck the check box.

## Important

- If you are using the XPS printer driver, see "[Editing the Print Document or Reprinting from the Print History](#)."

## Related Topic

- ➔ [Displaying the Print Results before Printing](#)

## Deleting the Undesired Print Job

If you are using the XPS printer driver, replace "Canon IJ Status Monitor" with "Canon IJ XPS Status Monitor" when reading this information.

If the printer does not start printing, canceled or failed print job data may be remaining. Delete the undesired print job by using the Canon IJ Status Monitor.

### 1. Display the Canon IJ Status Monitor

Click the icon of the Canon IJ Status Monitor displayed on the task bar.  
The Canon IJ Status Monitor appears.

### 2. Display the print jobs

Click **Display Print Queue**.  
The print queue window opens.

### 3. Delete the print jobs

Select **Cancel All Documents** from the **Printer** menu.  
When the confirmation message appears, click **Yes**.  
The deletion of the print job is complete.

### Important

- Users who have not been granted access permission for printer management cannot delete the print job of another user.

### Note

- When you perform this operation, all print jobs are deleted. If the print queue list contained a necessary print job, start the printing process over from the beginning.

## Instructions for Use (Printer Driver)

This printer driver is subject to the following restrictions. Keep the following points in mind when using the printer driver.

### Restrictions on the Printer Driver

- With some applications, the **Copies** setting in the **Page Setup** tab of the printer driver may not be enabled.  
In this case, use the copies setting in the **Print** dialog box of the application software.
- If the selected **Language** in the **About** dialog box of the **Maintenance** tab does not match the operating system interface language, the printer driver setup window may not be displayed properly.
- Do not change the **Advanced** tab items of the printer properties. If you change any of the items, you will not be able to use the following functions correctly.  
Also, if **Print to file** is selected in the **Print** dialog box of the application software and with applications that prohibit EMF spooling, such as Adobe Photoshop LE and MS Photo Editor, the following functions will not operate.
  - **Preview before printing** on the **Main** tab
  - **Prevention of Print Data Loss** in the **Print Options** dialog box on the **Page Setup** tab
  - **Page Layout, Tiling/Poster, Booklet, Duplex Printing (Manual), Specify Margin..., Print from Last Page, Collate, and Stamp/Background... (Stamp...)** on the **Page Setup** tab
  - **Print a pattern for color adjustment** on the **Color Adjustment** tab in the **Manual Color Adjustment** dialog box
- Since the resolution in the preview display differs from the printing resolution, text and lines in the preview display may appear different from the actual print result.
- With some applications, the printing is divided into multiple print jobs.  
To cancel printing, delete all divided print jobs.
- If image data is not printed correctly, display the **Print Options** dialog box from the **Page Setup** tab and change the setting of **Disable ICM required from the application software**. This may solve the problem.

#### ▶▶▶ Note

- **Disable ICM required from the application software** cannot be used when the XPS printer driver is used.

- Do not start up the Canon IJ Network Tool while printing.
- Do not print when the Canon IJ Network Tool is running.

### Points to Note About Applications with Restrictions

- There are following restrictions in Microsoft Word (Microsoft Corporation).
  - When Microsoft Word has the same printing functions as the printer driver, use Word to specify them.
  - When **Fit-to-Page, Scaled, or Page Layout** is used for **Page Layout** on the **Page Setup** tab of the printer driver, the document may not print normally in certain versions of Word.
  - When **Page Size** in Word is set to "XXX Enlarge/Reduce", the document may not print normally in certain versions of Word.

If this happens, follow the procedure below.

1. Open Word's **Print** dialog box.

2. Open the [printer driver setup window](#), and on the **Page Setup** tab, set **Page Size** to the same paper size that you specified in Word.
  3. Set the **Page Layout** that you want, and then click **OK** to close the window.
  4. Without starting printing, close the **Print** dialog box.
  5. Open Word's **Print** dialog box again.
  6. Open the printer driver setup window and click **OK**.
  7. Start printing.
- If bitmap printing is enabled in Adobe Illustrator (Adobe Systems Incorporated), printing may take time or some data may not be printed. Print after unchecking the **Bitmap Printing** check box in the **Print** dialog box.

## Printer Driver Description

- ➔ [Quick Setup tab Description](#)
- ➔ [Main tab Description](#)
- ➔ [Page Setup tab Description](#)
- ➔ [Maintenance tab Description](#)
- ➔ [Canon IJ Preview Description](#)
- ➔ [Canon IJ XPS Preview Description](#)
- ➔ [Canon IJ Status Monitor Description](#)

## Quick Setup tab Description

The **Quick Setup** tab is for registering commonly used print settings. When you select a registered setting, the printer automatically switches to the preset items.

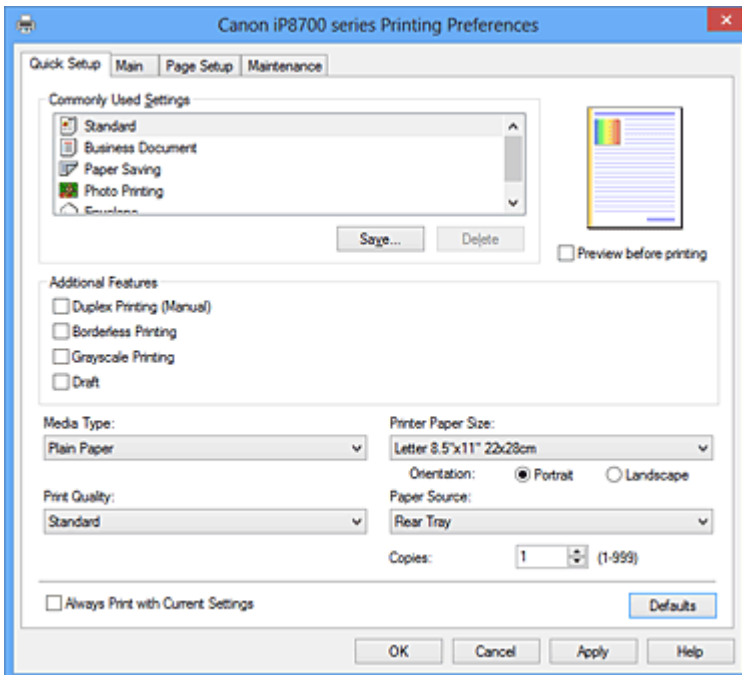

### Commonly Used Settings

The names and icons of frequently used printing profiles are registered. When you select a printing profile according to the purpose of the document, settings that match the purpose are applied. In addition, functions that are thought to be useful for the selected printing profile are displayed in **Additional Features**.

You can also change a printing profile and register it under a new name. You can delete the registered printing profile.

You can rearrange the profiles either by dragging the individual profiles or by holding down the Ctrl key and pressing the up or down arrow keys.

#### Standard

These are the factory settings.

If **Page Size**, **Orientation**, and **Copies** were set from the application software, those settings have priority.

#### Business Document

Select this setting when printing a general document.

If **Page Size**, **Orientation**, and **Copies** were set from the application software, those settings have priority.

#### Paper Saving

Select this setting to save paper when printing a general document. The **2-on-1 Printing** and **Duplex Printing (Manual)** check boxes are checked automatically.

If **Page Size**, **Orientation**, and **Copies** were set from the application software, those settings have priority.

#### Photo Printing

If you select this setting when printing a photo, the photo paper and photo size generally used are set. The **Borderless Printing** check box is checked automatically.

If **Orientation** and **Copies** were set from the application software, those settings have priority.

## Envelope

If you select this setting for printing an envelope, **Media Type** is set automatically to **Envelope**. In the **Envelope Size Setting** dialog box, select the size of the envelope to be used.

### ▶▶▶ Note

- The combination of the **Additional Features** that was displayed for the printing profile that had been selected when the added printing profile was saved is also displayed when that added printing profile is selected.

## Save...

Displays the [Save Commonly Used Settings dialog box](#).

Click this button when you want to save the information that you set on the **Quick Setup**, **Main**, and **Page Setup** tabs to **Commonly Used Settings**.

## Delete

Deletes a registered printing profile.

Select the name of the setting to be deleted from **Commonly Used Settings**, and click **Delete**. When a confirmation message is displayed, click **OK** to delete the specified printing profile.

### ▶▶▶ Note

- Printing profiles that are registered in the initial settings cannot be deleted.

## Settings Preview

The paper illustration shows how the original will be laid out on a sheet of paper.

You can check an overall image of the layout.

## Preview before printing

Shows what the print result will look like before you actually print the data.

Check this check box to display a preview before printing.

Uncheck this check box if you do not want to display a preview.

### ▶▶▶ Important

- To use the Canon IJ XPS Preview, you must have Microsoft .NET Framework 4 Client Profile installed on your computer.

## Additional Features

Displays the frequently used, convenient functions for the printing profile that you selected for **Commonly Used Settings** on the **Quick Setup** tab.

When you move the mouse pointer near a function that can be changed, a description of that function is displayed.

To enable a function, check the corresponding check box.

For some functions, you can set detailed settings from the **Main** and **Page Setup** tabs.

### ▶▶▶ Important

- Depending on the printing profiles, certain function may be grayed out and you will not be able to change them.

## 2-on-1 Printing

Prints two pages of the document, side by side, on one sheet of paper.

To change the page sequence, click the **Page Setup** tab, select **Page Layout** for **Page Layout**, and click **Specify...**. Then in the [Page Layout Printing dialog box](#) that appears, specify the **Page Order**.

#### **4-on-1 Printing**

Prints four pages of the document, side by side, on one sheet of paper.

To change the page sequence, click the **Page Setup** tab, select **Page Layout** for **Page Layout**, and click **Specify...** Then in the [Page Layout Printing dialog box](#) that appears, specify the **Page Order**.

#### **Duplex Printing (Manual)**

Select whether to print the document to both sides of the paper manually or to one side of the paper.

To change the staple side or the margins, set the new values from the **Page Setup** tab.

#### **Borderless Printing**

Performs borderless printing without any margins on the paper.

With the borderless printing function, the document to be printed is enlarged, so that it extends slightly off the paper. In other words, the document is printed without any margin.

To adjust the amount that the document extends beyond the paper, click the **Page Setup** tab, choose **Borderless**, and enter the value in **Amount of Extension**.

#### **Grayscale Printing**

This function converts the data to monochrome data when printing your document.

#### **Draft**

This setting is appropriate for test printing.

#### **Rotate 180 degrees**

Prints the document by rotating it 180 degrees against the paper feed direction.

The width of print area and the amount of extension that are configured in other application software will be reversed vertically and horizontally.

#### **Color/Intensity Manual Adjustment**

Select when you set the **Color Correction** method and individual settings such as **Cyan, Magenta, Yellow, Tone, Brightness, Intensity, and Contrast**, etc.

#### **Media Type**

Selects a type of printing paper.

Select a media type that matches the paper that is loaded in the printer. This ensures that printing is carried out properly for the specified paper.

#### **Printer Paper Size**

Selects the size of paper actually loaded into the printer.

Normally, the paper size is set automatically according to the output paper size setting, and the document is printed with no scaling.

When you set **2-on-1 Printing** or **4-on-1 Printing** in **Additional Features**, you can manually set the paper size with **Page Size** on the **Page Setup** tab.

If you select a paper size that is smaller than the **Page Size**, the page image will be reduced.

If you select a paper size that is larger than the **Page Size**, the page image will be enlarged.

#### **Orientation**

Selects the printing orientation.

If the application used to create your document has a similar function, select the same orientation that you selected in that application.

#### **Portrait**

Prints the document so that its top and bottom positions are unchanged relative to the paper feed direction. This is the default setting.



## Landscape

Prints the document by rotating it 90 degrees relative to the paper feed direction.

You can change the rotation direction by going to the **Maintenance** tab, opening the **Custom Settings** dialog box, and then using **Rotate 90 degrees left when orientation is [Landscape]** check box.

To rotate the document 90 degrees to the left when printing, select the **Rotate 90 degrees left when orientation is [Landscape]** check box.

## Print Quality

Selects your desired printing quality.

Select one of the following to set the print quality level that is appropriate for the purpose.

To set the print quality level individually, click the **Main** tab, and for **Print Quality**, select **Custom**. The **Set...** becomes enabled. Click **Set...** to open the [Custom dialog box](#), and then specify the desired settings.

### High

Gives priority to print quality over printing speed.

### Standard

Prints with average speed and quality.

### Draft

This setting is appropriate for test printing.

## Paper Source

Shows the source from which paper is supplied.

### Rear Tray

Paper is always supplied from the rear tray.

## Copies

Specifies the number of copies you want to print. You can specify a value from 1 to 999.

### ▶▶▶ Important

- When the application software that you used to create the document has the same function, specify the settings on the printer driver. However, if the print results are not acceptable, specify the function settings on the application software.

## Always Print with Current Settings

Prints documents with the current settings starting from the next print execution.

When you select this function and then close the [printer driver setup window](#), the information that you set on the **Quick Setup**, **Main**, and **Page Setup** tabs are saved and printing with the same settings is possible starting from the next print execution.

### ▶▶▶ Important

- If you log on with a different user name, the settings that were set when this function was enabled are not reflected in the print settings.
- If a setting was specified on the application software, it has priority.

## Defaults

Restores all the settings you have changed to their default values.

Click this button to return all settings on the **Quick Setup**, **Main**, and **Page Setup** tabs to their default values (factory settings).

## Save Commonly Used Settings dialog box

This dialog box allows you to save the information that you set on the **Quick Setup**, **Main**, and **Page Setup** tabs and add the information to the **Commonly Used Settings** list on the **Quick Setup** tab.

### Name

Enter the name for the printing profile you wish to save.

Up to 255 characters can be entered.

The name appears, with its associated icon, in the **Commonly Used Settings** list on the **Quick Setup** tab.

### Options...

Opens the [Save Commonly Used Settings dialog box](#).

Changes the details of printing profile to be saved.

## Save Commonly Used Settings dialog box

Select the icons of the printing profiles to be registered to **Commonly Used Settings**, and change the items to be saved in the printing profiles.

### Icon

Select the icon for the printing profile you wish to save.

The selected icon appears, with its name, in the **Commonly Used Settings** list on the **Quick Setup** tab.

### Save the paper size setting

Saves the paper size to the printing profile in **Commonly Used Settings**.

To apply the saved paper size when the printing profile is selected, check this check box.

If this check box is unchecked, the paper size is not saved, and consequently the paper size setting is not applied when the printing profile is selected. Instead the printer prints with the paper size specified with the application software.

### Save the orientation setting

Saves the **Orientation** to the printing profile in **Commonly Used Settings**.

To apply the saved print orientation when the printing profile is selected, check this check box.

If this check box is unchecked, the print orientation is not saved, and consequently the **Orientation** setting is not applied when the printing profile is selected. Instead the printer prints with the print orientation specified with the application software.

### Save the copies setting

Saves the **Copies** setting to the printing profile in **Commonly Used Settings**.

To apply the saved copies setting when the printing profile is selected, check this check box.

If this check box is unchecked, the copies setting is not saved, and consequently the **Copies** setting is not applied when the printing profile is selected. Instead the printer prints with the copies setting specified with the application software.

## Custom Paper Size dialog box

This dialog box allows you to specify the size (width and height) of the custom paper.

### Units

Select the unit for entering a user-defined paper size.

## Paper Size

Specifies the **Width** and the **Height** of the custom paper. Measurement is shown according to the units specified in **Units**.

## Related Topics

- ➔ [Printing with Easy Setup](#)
- ➔ [Setting a Page Size and Orientation](#)
- ➔ [Setting the Number of Copies and Printing Order](#)
- ➔ [Execute Borderless Printing](#)
- ➔ [Duplex Printing](#)
- ➔ [Setting Up Envelope Printing](#)
- ➔ [Printing on Postcards](#)
- ➔ [Displaying the Print Results before Printing](#)
- ➔ [Setting Paper Dimensions \(Custom Size\)](#)
- ➔ [Printing a Color Document in Monochrome](#)
- ➔ [Specifying Color Correction](#)
- ➔ [Adjusting Color Balance](#)
- ➔ [Adjusting Color Balance Using Sample Patterns \(Printer Driver\)](#)
- ➔ [Adjusting Brightness](#)
- ➔ [Adjusting Intensity](#)
- ➔ [Adjusting Contrast](#)
- ➔ [Adjusting Intensity/Contrast Using Sample Patterns \(Printer Driver\)](#)
- ➔ [Registering a Frequently Used Printing Profile](#)

## Main tab Description

The **Main** tab allows you to create a basic print setup in accordance with the media type. Unless special printing is required, normal printing can be performed just by setting the items on this tab.

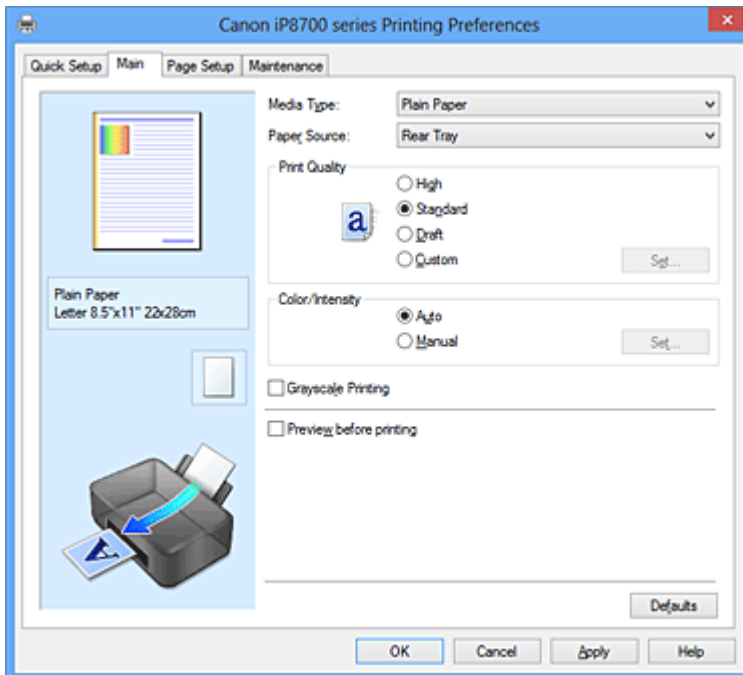

### Settings Preview

The paper illustration shows how the original will be laid out on a sheet of paper. You can check an overall image of the layout.

### Media Type

Selects a type of printing paper.

Select a media type that matches the paper that is loaded in the printer. This ensures that printing is carried out properly for the specified paper.

### Paper Source

Shows the source from which paper is supplied.

#### Rear Tray

Paper is always supplied from the rear tray.

### Print Quality

Selects your desired printing quality.

Select one of the following to set the print quality level that is appropriate for the purpose.

#### ►►► Important

- Depending on the **Media Type** settings, the same print results may be produced even if the **Print Quality** is changed.

#### High

Gives priority to print quality over printing speed.

#### Standard

Prints with average speed and quality.

#### Draft

This setting is appropriate for test printing.

## Custom

Select this when you want to set the printing quality level individually.

### Set...

Select **Custom** for **Print Quality** to enable this button.

Open the [Custom dialog box](#). You can then individually set the print quality level.

## Color/Intensity

Selects color adjustment method.

### Auto

**Cyan, Magenta, Yellow, Brightness, Intensity, and Contrast**, and so on are adjusted automatically.

### Manual

Select when you set the individual settings such as **Cyan, Magenta, Yellow, Tone, Brightness, Intensity, and Contrast**, etc. and **Color Correction** method.

### Set...

Select **Manual** for **Color/Intensity** to enable this button.

In the **Manual Color Adjustment** dialog box, you can adjust individual color settings such as **Cyan, Magenta, Yellow, Tone, Brightness, Intensity, and Contrast** on the [Color Adjustment tab](#), and select the **Color Correction** method on the [Matching tab](#).

### ▶▶▶ Note

- If you want to use an ICC profile to adjust colors, use the **Manual Color Adjustment** dialog box to set the profile.

## Grayscale Printing

This function converts the data to monochrome data when printing your document.

Check this check box to print a color document in monochrome.

## Preview before printing

Shows what the print result will look like before you actually print the data.

Check this check box to display a preview before printing.

### ▶▶▶ Important

- To use the Canon IJ XPS Preview, you must have Microsoft .NET Framework 4 Client Profile installed on your computer.

## Defaults

Restores all the settings you have changed to their default values.

Clicking this button restores all the settings on the current screen to their default values (factory settings).

## Custom dialog box

Set the quality level, and select the desired print quality.

### Quality

You can use the slider bar to adjust the print quality level.

### ▶▶▶ Important

- Certain print quality levels cannot be selected depending on the settings of **Media Type**.

## »» Note

- The **High**, **Standard**, or **Draft** print quality modes are linked with the slider bar. Therefore when the slider bar is moved, the corresponding quality and value are displayed on the left. This is the same as when the corresponding radio button is selected for **Print Quality** on the **Main** tab.

## Color Adjustment Tab

This tab allows you to adjust the color balance by changing the settings of the **Cyan**, **Magenta**, **Yellow**, **Tone**, **Brightness**, **Intensity**, and **Contrast** options.

### Preview

Shows the effect of color adjustment.

The color and brightness change when each item is adjusted. You can check the color adjustment status easily by changing the preview image to one similar to the results to be printed with **Sample Type**.

## »» Note

- The graphic is in monochrome when the **Grayscale Printing** check box is checked.

### Sample Type

Selects a preview image displayed on the **Color Adjustment** tab.

If necessary, select a preview image from **Standard**, **Portrait**, **Landscape**, or **Graphics**, whichever is most similar to the print results.

### View Color Pattern

Displays a pattern for checking color changes produced by color adjustment.

If you want to display the preview image with a color pattern, check this check box.

### Cyan / Magenta / Yellow

Adjusts the strengths of **Cyan**, **Magenta**, and **Yellow**.

Moving the slider to the right makes a color stronger, and moving the slider to the left makes a color weaker.

You can also directly enter a value linked to the slider. Enter a value in the range from -50 to 50.

This adjustment changes the relative amount of ink of each color used, which alters the total color balance of the document. Use your application if you want to change the total color balance significantly. Use the printer driver only if you want to adjust the color balance slightly.

## »» Important

- When **Grayscale Printing** is checked on the **Main** tab, **Cyan**, **Magenta**, and **Yellow** appear grayed out and are unavailable.

### Tone

Sets the color adjustment for monochrome printing.

Moving the slider to the right produces warm colors (Warm), and moving the slider to the left produces cool colors (Cool).

You can also directly enter a value linked to the slider. Enter a value in the range from -50 to 50.

## »» Important

- This function is not available for certain **Media Type** settings.

## Brightness

Selects the brightness of your print.

You cannot change the levels of pure white and black. However, the brightness of the colors between white and black can be changed.

## Intensity

Adjusts the overall intensity of your print.

Moving the slider to the right increases the intensity, and moving the slider to the left decreases the intensity.

You can also directly enter a value linked to the slider. Enter a value in the range from -50 to 50.

## Contrast

Adjusts the contrast between light and dark in the image to be printed.

Moving the slider to the right increases the contrast, moving the slider to the left decreases the contrast.

You can also directly enter a value linked to the slider. Enter a value in the range from -50 to 50.

## Print a pattern for color adjustment

When the color balance, monochromatic color tones, or intensity/contrast is changed, the pattern printing function prints a list of the adjustment results along with the adjustment values.

Select this function when printing a pattern for color adjustment.

## Pattern Print preferences...

Check **Print a pattern for color adjustment** to enable this button.

The [Pattern Print dialog box](#) opens and allows you to set pattern printing settings.

## Pattern Print dialog box

Performs the setup for printing of patterns that allow you to check the color balance and intensity/contrast of documents.

### Parameters to Adjust

Select the item to be checked by pattern printing.

#### Cyan/Magenta/Yellow

Prints a pattern that allows you to check the cyan/magenta/yellow balance.

#### ▶▶▶ Important

- When **Grayscale Printing** is checked on the **Main** tab, **Cyan/Magenta/Yellow** appear grayed out and are unavailable.

#### Intensity/Contrast

Prints a pattern that allows you to check the intensity/contrast balance.

### Printer Paper Size

Selects the paper size to be used for pattern printing.

This setting is linked to **Printer Paper Size** on the **Page Setup** tab.

#### ▶▶▶ Note

- Depending on the paper size selected on the **Page Setup** tab, there may be sizes that cannot be selected.

### Amount of Pattern Instances

Sets the number of patterns to be printed.

You can select from **Largest**, **Large**, and **Small**. When you select a pattern size, the number of patterns that can be printed is as follows:

## ▶▶▶ Note

- **Largest** and **Large** cannot be selected when certain paper sizes or output paper sizes are selected.
- The setting preview on the **Main** tab displays an image that allows you to check the overall layout.

### Largest

**Cyan/Magenta/Yellow** 37

**Intensity/Contrast** 49

### Large

**Cyan/Magenta/Yellow** 19

**Intensity/Contrast** 25

### Small

**Cyan/Magenta/Yellow** 7

**Intensity/Contrast** 9

### Color Variation Between Instances

Sets the amount of color change between neighboring patterns.

Select from **Large**, **Medium**, and **Small**. **Large** produces a large amount of change, and **Small** produces a small amount of change.

## ▶▶▶ Note

- **Large** is about double the size of **Medium**, and **Small** is about half the size of **Medium**.

## Matching Tab

Allows you to select the method for adjusting colors to match the type of document to be printed.

### Color Correction

Allows you to select **Driver Matching**, **ICM (ICC Profile Matching)**, or **None** to match the purpose of the print operation.

#### ▶▶▶ Important

- When **Grayscale Printing** is checked on the **Main** tab, **Color Correction** appears grayed out and is unavailable.

## ▶▶▶ Note

- In the XPS printer driver, **ICM** has become **ICC Profile Matching**.

### Driver Matching

With Canon Digital Photo Color, you can print sRGB data with color tints that most people prefer.

### ICM (ICC Profile Matching)

Adjusts the colors by using an ICC profile when printing.

Specify the input profile and rendering intent to be used.

#### ▶▶▶ Important

- If the application software is set so that ICM is disabled, **ICM** is unavailable for **Color Correction** and the printer may not be able to print the image data properly.

### None

Disables color adjustment with the printer driver.



## Input Profile

Specifies the input profile to be used when you select **ICM (ICC Profile Matching)** for **Color Correction**.

### Standard

The standard printer profile (sRGB), which supports the color space of ICM, is used. This is the default setting.

### Adobe RGB (1998)

The Adobe RGB profile, which supports a wider color space than sRGB, is used.

### ▶▶▶ Important

- **Adobe RGB (1998)** is not displayed when input profiles of Adobe RGB are not installed.

## Rendering Intent

Specifies the matching method to be used when you select **ICM (ICC Profile Matching)** for **Color Correction**.

### Saturation

This method reproduces images even more vividly than the **Perceptual** method.

### Perceptual

This method reproduces images by focusing on colors that most people find desirable.

Select this method to print photos.

### Relative Colorimetric

When image data is converted to the color space of the printer, this method converts the image data so the color reproduction approximates the shared color regions. Select this method to print image data with colors that are close to the original colors.

### Absolute Colorimetric

When **Relative Colorimetric** is selected, white spots are reproduced as white spots of the paper (background color). However, when **Absolute Colorimetric** is selected, how the white spots are reproduced depends on the image data.

## Related Topics

- ➔ [Setting the Print Quality Level \(Custom\)](#)
- ➔ [Adjusting Color Balance](#)
- ➔ [Adjusting Brightness](#)
- ➔ [Adjusting Intensity](#)
- ➔ [Adjusting Contrast](#)
- ➔ [Adjusting Color Balance Using Sample Patterns \(Printer Driver\)](#)
- ➔ [Adjusting Intensity/Contrast Using Sample Patterns \(Printer Driver\)](#)
- ➔ [Specifying Color Correction](#)
- ➔ [Adjusting Colors with the Printer Driver](#)
- ➔ [Printing with ICC Profiles](#)
- ➔ [Printing a Color Document in Monochrome](#)
- ➔ [Displaying the Print Results before Printing](#)

# Page Setup tab Description

The **Page Setup** tab allows you to determine how a document is to be arranged on the paper. Also, this tab allows you to set the number of copies and the order of printing. If the application which created the document has a similar function, set them with the application.

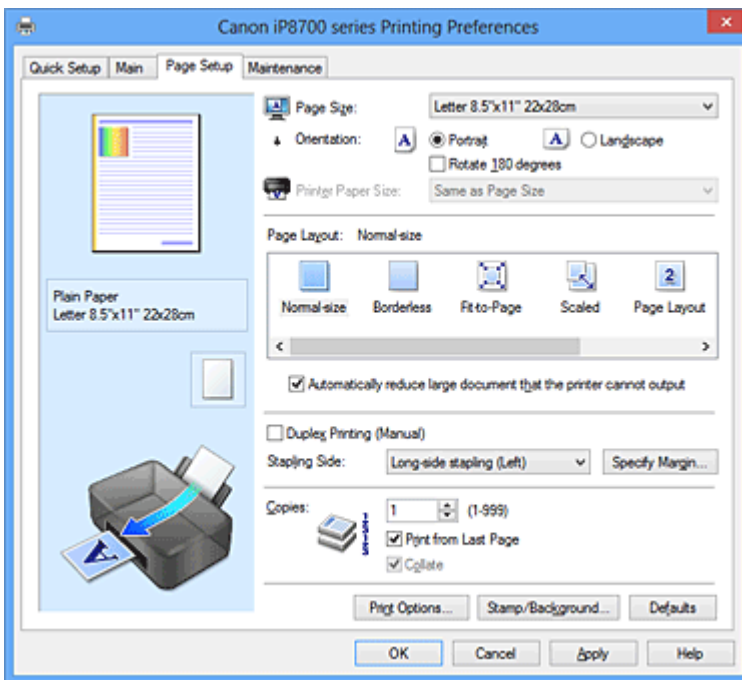

## Settings Preview

The paper illustration shows how the original will be laid out on a sheet of paper. You can check an overall image of the layout.

## Page Size

Selects a page size.

Ensure that you select the same page size as you selected within the application.

## Orientation

Selects the printing orientation.

If the application used to create your document has a similar function, select the same orientation that you selected in that application.

### Portrait

Prints the document so that its top and bottom positions are unchanged relative to the paper feed direction. This is the default setting.

### Landscape

Prints the document by rotating it 90 degrees relative to the paper feed direction.

You can change the rotation direction by going to the **Maintenance** tab, opening the **Custom Settings** dialog box, and then using **Rotate 90 degrees left when orientation is [Landscape]** check box.

To rotate the document 90 degrees to the left when printing, select the **Rotate 90 degrees left when orientation is [Landscape]** check box.

### Rotate 180 degrees

Prints the document by rotating it 180 degrees against the paper feed direction.

The width of print area and the amount of extension that are configured in other application software will be reversed vertically and horizontally.

## Printer Paper Size

Selects the size of paper actually loaded into the printer.

The default setting is **Same as Page Size** to perform normal-sized printing.

You can select a printer paper size when you select **Fit-to-Page**, **Scaled**, **Page Layout**, **Tiling/Poster**, or **Booklet** for **Page Layout**.

If you select a paper size that is smaller than the **Page Size**, the document size will be reduced. If you select a paper size that is larger than the **Page Size**, the document size will be enlarged.

## Page Layout

Selects the size of the document you want to print and the type of printing.

### Normal-size

This is the normal printing method. Select this when you do not specify any page layout.

#### Automatically reduce large document that the printer cannot output

If the printer cannot print the paper size of a document, the printer can automatically reduce the size when it prints the document.

Check this check box to reduce the size when printing the document.

### Borderless

Chooses whether you are printing on a full page without any page margins or printing with page margins.

In borderless printing, originals are enlarged to extend slightly off the paper. Thus, printing can be performed without any margins (border).

Use **Amount of Extension** to adjust how much of the document extends off the paper during borderless printing.

#### Amount of Extension

Adjusts how much of the document extends off the paper during borderless printing.

Moving the slider to the right increases the amount of extension and allows you to perform borderless printing with no problems.

Moving the slider to the left reduces the amount of extension and expands the range of the document to print.

### Fit-to-Page

This function enables you to automatically enlarge or reduce documents to fit to the paper size loaded in the printer without changing the paper size you specified in your application software.

### Scaled

Documents can be enlarged or reduced to be printed.

Specify the size in **Printer Paper Size**, or enter the scaling ratio in the **Scaling** box.

#### Scaling

Specifies an enlargement or reduction ratio for the document you want to print.

### Page Layout

Multiple pages of document can be printed on one sheet of paper.

#### Specify...

Opens the [Page Layout Printing dialog box](#).

Click this button to set details on page layout printing.

### Tiling/Poster

This function enables you to enlarge the image data and divide the enlarged data into several pages to be printed. You can also glue together these sheets of paper to create large printed matter, such as a poster.

#### Specify...

Opens the [Tiling/Poster Printing dialog box](#).

Click this button to set details on tiling/poster printing.

## Booklet

Booklet printing is the convenient function to create a booklet. Data is printed on both sides of a sheet of paper. This type of printing ensures that pages can be collated properly, in page number order, when the printed sheets are folded and stapled at the center.

### Specify...

Opens the [Booklet Printing dialog box](#).

Click this button to set details on booklet printing.

## Duplex Printing (Manual)

Select whether to print the document to both sides of the paper manually or to one side of the paper. Check this check box to print the document on both sides.

This function can be used only when **Plain Paper** is selected for **Media Type** and one of **Normal-size**, **Fit-to-Page**, **Scaled**, or **Page Layout** is selected.

## Stapling Side

Selects the stapling margin position.

The printer analyzes the **Orientation** and **Page Layout** settings, and automatically selects the best stapling margin position. Check **Stapling Side**, and select from the list to change it.

## Specify Margin...

Opens the [Specify Margin dialog box](#).

You can specify the width of the margin.

## Copies

Specifies the number of copies you want to print. You can specify a value from 1 to 999.

### »»» Important

- If the application used to create your document has a similar function, specify the number of copies with the application without specifying it here.

## Print from Last Page

Check this check box when you want to print from the last page in order. If you do this, you do not need to sort the pages into their correct order after printing.

Uncheck this check box to print your document in normal order, starting from the first page.

## Collate

Check this check box to group together the pages of each copy when you want to print multiple copies. Uncheck this check box when you want to print with all pages of the same page number grouped together.

### »»» Important

- When the application software that you used to create the document has the same function, give priority to the printer driver settings. However, if the print results are not acceptable, specify the function settings on the application software. When you specify the number of copies and the printing order with both the application and this printer driver, the number of copies may be multiplied numbers of the two settings or the specified printing order may not be enabled.

## Print Options...

Opens the [Print Options dialog box](#).

Changes detailed printer driver settings for print data that is sent from applications.

## Stamp/Background... (Stamp...)

Opens the [Stamp/Background \(Stamp\) dialog box](#).

The **Stamp** function allows you to print a stamp text or a bitmap over or behind document data. It also

allows you to print date, time and user name. The **Background** function allows you to print a light illustration behind the document data.

### »» Note

- With the XPS printer driver, the **Stamp/Background...** button has become the **Stamp...** button and only the stamp function can be used.

Depending on the type of printer driver you are using and the environment, **Stamp** and **Background** may not be available.

## Custom Paper Size dialog box

This dialog box allows you to specify the size (width and height) of the custom paper.

### Units

Select the unit for entering a user-defined paper size.

### Paper Size

Specifies the **Width** and the **Height** of the custom paper. Measurement is shown according to the units specified in **Units**.

## Page Layout Printing dialog box

This dialog box allows you to select the number of document pages to be placed on one sheet of paper, the page order, and whether a page border line is to be printed around each document page.

The settings specified in this dialog box can be confirmed in the settings preview on the printer driver.

### Preview Icon

Shows the settings made on the **Page Layout Printing** dialog box.

You can check what the print result will look like before you actually print the data.

### Pages

Specifies the number of document pages to fit on one sheet.

### Page Order

Specifies the document orientation to be printed on a sheet of paper.

### Page Border

Prints a page border line around each document page.

Check this check box to print the page border line.

## Tiling/Poster Printing dialog box

This dialog box allows you to select the size of the image to be printed. You can also make settings for cut lines and paste markers which are convenient for pasting together the pages into a poster.

The settings specified in this dialog box can be confirmed in the settings preview on the printer driver.

### Preview Icon

Shows the settings of the **Tiling/Poster Printing** dialog box.

You can check what the print result will look like.

### Image Divisions

Select the number of divisions (vertical x horizontal).

As the number of divisions increases, the number of sheets used for printing increases. If you are

pastings pages together to create a poster, increasing the number of divisions allows you to create a larger poster.

#### **Print "Cut/Paste" in margins**

Specifies whether to print the words "Cut" and "Paste" in the margins. These words serve as guidelines for pasting together the pages into a poster.

Check this check box to print the words.

#### **»»» Note**

- Depending on the type of printer driver you are using and the environment, this function may not be available.

#### **Print "Cut/Paste" lines in margins**

Specifies whether to print cut lines that serve as guidelines for pasting together the pages into a poster.

Check this check box to print the cut lines.

#### **Print page range**

Specifies the printing range. Select **All** under normal circumstances.

Select **Pages** to specify a specific page or range.

#### **»»» Note**

- If some of the pages have not been printed well, specify the pages that do not need to be printed by clicking them in the settings preview of the **Page Setup** tab. Only the pages shown on the screen will be printed this time.

## **Booklet Printing dialog box**

This dialog box allows you to set how to bind the document as a booklet. Printing only on one side and printing a page border, can also be set in this dialog box.

The settings specified in this dialog box can be confirmed in the settings preview on the printer driver.

#### **Preview Icon**

Shows the settings made on the **Booklet Printing** dialog box.

You can check what the document will look like when printed as a booklet.

#### **Margin for stapling**

Specifies which side of the booklet is to be stapled.

#### **Insert blank page**

Selects whether to print the document on one side or both sides of the booklet.

Check this check box to print the document on one side of the booklet and select the side to be left blank from the list.

#### **Margin**

Specifies the width of the stapling margin.

The specified width becomes the stapling margin from the center of the sheet.

#### **Page Border**

Prints a page border line around each document page.

Check this check box to print the page border line.

## Specify Margin dialog box

This dialog box allows you to specify the margin width for the side to be stapled. If a document does not fit on one page, the document is reduced when printed.

### Margin

Specifies the width of the stapling margin.

The width of the side specified by **Stapling Side** becomes the stapling margin.

## Print Options dialog box

Makes changes to print data that is sent to the printer.

Depending on the type of printer driver you are using and the environment, this function may not be available.

### Disable ICM required from the application software

Disables the ICM function required from the application software.

When an application software uses Windows ICM to print data, unexpected colors may be produced or the printing speed may decrease. If these problems occur, checking this check box may resolve the problems.

#### ▶▶▶ Important

- Uncheck this check box under normal circumstances.
- This function does not work when **ICM** is selected for **Color Correction** on the **Matching** tab of the **Manual Color Adjustment** dialog box.

#### ▶▶▶ Note

- **Disable ICM required from the application software** tab cannot be used with the XPS printer driver.

### Disable the color profile setting of the application software

Checking this check box disables information in the color profile that was set on the application software.

When the information in the color profile set on the application software is output to the printer driver, the print result may contain unexpected colors. If this happens, checking this check box may resolve the problem.

#### ▶▶▶ Important

- Even when this check box is checked, only some of the information in the color profile is disabled, and the color profile can still be used for printing.
- Uncheck this check box under normal circumstances.

### Ungroup Papers

Sets the display method of **Media Type**, **Page Size**, and **Printer Paper Size**.

To display the items separately, select the check box.

To display the items as a group, clear the check box.

### Do not allow application software to compress print data

Compression of the application software print data is prohibited.

If the print result has missing image data or unintended colors, selecting this check box may improve the condition.

### »»» Important

- Uncheck this check box under normal circumstances.

### »»» Note

- **Do not allow application software to compress print data** tab cannot be used with the XPS printer driver.

#### Print after creating print data by page

The print data is created in page units, and printing starts after the processing of one page of print data is complete.

If a printed document contains unintended results such as streaks, selecting this check box may improve the results.

### »»» Important

- Uncheck this check box under normal circumstances.

#### Scale images using nearest-neighbor interpolation

When an image is to be enlarged or reduced when printed, the printer uses a simple interpolation process to enlarge or reduce the image.

If the image data in a printed document is not printed clearly, selecting this check box may improve the results.

### »»» Important

- Uncheck this check box under normal circumstances.

### »»» Note

- **Scale images using nearest-neighbor interpolation** can be used only with the XPS printer driver.

#### Prevention of Print Data Loss

You can reduce the size of the print data that was created with the application software and then print the data.

Depending on the application software being used, the image data may be cut off or may not be printed properly. In such cases, select **On**. If you will not be using this function, select **Off**.

### »»» Important

- When using this function, the print quality may drop depending on the print data.

#### Unit of Print Data Processing

Selects the processing unit of the print data to be sent to the printer.

Select **Recommended** under normal circumstances.

### »»» Important

- A large amount of memory may be used for certain settings.  
Do not change the setting if your computer has a small amount of memory.

### »»» Note

- **Unit of Print Data Processing** tab cannot be used with the XPS printer driver.



## Stamp/Background (Stamp...) dialog box

The **Stamp/Background (Stamp...)** dialog box allows you to print a stamp and/or background over or behind the document pages. In addition to the pre-registered ones, you can register and use your original stamp or background.

### »»» Note

- With the XPS printer driver, the **Stamp/Background...** button has become the **Stamp...** button and only the stamp function can be used.

### Stamp

Stamp printing is a function that prints a stamp over a document.

Check this check box and select a title from the list to print a stamp.

### Define Stamp...

Opens the **Stamp Settings** dialog box.

You can check the details of a selected stamp or save a new stamp.

### Place stamp over text

Sets how the stamp is to be printed over the document.

Check the **Stamp** check box to enable this.

Check this check box to print a stamp over the printed document page. The printed data may be hidden behind the stamp.

Uncheck this check box to print the document data over the stamp. The printed data will not be hidden behind the stamp.

### »»» Note

- The stamp is given priority because the stamp is printed over the document data in the sections where the stamp and the document data overlap. When this check box is unchecked, the stamp is printed behind the document data and may be hidden in the overlapping sections depending on the application software used.

### Print semitransparent stamp

Sets how the stamp is to be printed over the document.

Check the **Stamp** check box to enable this.

Check this check box to print a semi-transparent stamp over the printed document page.

Uncheck this check box to print the stamp over the document data. The printed data may be hidden behind the stamp.

### »»» Note

- You can use **Print semitransparent stamp** only with the XPS printer driver.

### Stamp first page only

Selects whether the stamp is to be printed on the first page only or on all pages when the document has two or more pages.

Check the **Stamp** check box to enable this.

Check this check box to print a stamp on the first page only.

### Background

Background printing is a function that allows you to print an illustration or a similar object (bitmap, etc.) behind the document.

Check this check box to print a background and select a title from the list.

## Select Background...

Opens the **Background Settings** dialog box.

You can register a bitmap as a background, and change layout method and intensity of the selected background.

## Background first page only

Selects whether to print the background on the first page only or print on all pages when the document has two or more pages.

Check the **Background** check box to enable this.

Check this check box to print a background on the first page only.

## Stamp Tab

The Stamp tab allows you to set the text and bitmap file (.bmp) to be used for a stamp.

### Preview Window

Shows the status of the stamp configured in each tab.

### Stamp Type

Specifies the stamp type.

Select **Text** to create a stamp with characters. Select **Bitmap** to create with a bitmap file. Select **Date/Time/User Name** to display the creation date/time and user name of the printed document.

The setting items in the **Stamp** tab change depending on the selected type.

When **Stamp Type** is **Text** or **Date/Time/User Name**

### Stamp Text

Specifies the stamp text string.

Up to 64 characters can be entered.

For **Date/Time/User Name**, the creation date/time and user name of the printed object are displayed in **Stamp Text**.

### ▶▶▶ Important

- **Stamp Text** appears grayed out and is unavailable if **Date/Time/User Name** is selected.

### TrueType Font

Selects the font for the stamp text string.

### Style

Selects the font style for the stamp text string.

### Size

Selects the font size for the stamp text string.

### Outline

Selects a frame that encloses the stamp text string.

If a large font size is selected for **Size**, characters may extend outside of the stamp border.

### Color/Select Color...

Shows the current color for the stamp.

To select a different color, click **Select Color...** to open the **Color** dialog box, and select or create a color you wish to use as a stamp.

When **Stamp Type** is **Bitmap**

### File

Specifies the name of the bitmap file to be used as the stamp.

### Select File...

Opens the dialog box to open a file.

Click this button to select a bitmap file to be used as a stamp.

### Size

Adjusts the size of the bitmap file to be used as a stamp.

Moving the slider to the right increases the size, moving the slider to the left decreases the size.

### Transparent white area

Specifies whether to make white-filled areas of the bitmap transparent.

Check this check box to make white-filled areas of the bitmap transparent.

### ►►► Note

- Click **Defaults** to set **Stamp Type** to text, **Stamp Text** to blank, **TrueType Font** to Arial, **Style** to Regular, **Size** to 36 points, **Outline** unchecked, and **Color** to gray with the RGB values (192, 192, 192).

## Placement Tab

The Placement tab allows you to set the position where the stamp is to be printed.

### Preview Window

Shows the status of the stamp configured in each tab.

### Position

Specifies the stamp position on the page.

Selecting **Custom** from the list allows you to enter values for the **X-Position** and **Y-Position** coordinates directly.

### Orientation

Specifies the angle of rotation for the stamp. The angle can be set by entering the number of degrees.

Negative values rotate the stamp clockwise.

### ►►► Note

- **Orientation** is enabled only when **Text** or **Date/Time/User Name** is selected for **Stamp Type** on the **Stamp** tab.

### ►►► Note

- Click **Defaults** to set the stamp position to **Center** and the orientation to 0.

## Save settings Tab

The **Save settings** tab allows you to register a new stamp or delete an unnecessary stamp.

### Title

Enter the title to save the stamp you created.

Up to 64 characters can be entered.

### ►►► Note

- Spaces, tabs, and returns cannot be entered at the beginning or end of a title.

## Stamps

Shows a list of saved stamp titles.

Specify a title to display the corresponding stamp in **Title**.

## Save/Save overwrite

Saves the stamp.

Enter a title in **Title**, and then click this button.

## Delete

Deletes an unnecessary stamp.

Specify the title of an unnecessary stamp from the **Stamps** list, and click this button.

## Background Tab

The Background tab allows you to select a bitmap file (.bmp) to be used as a background or determine how to print the selected background.

### Preview Window

Shows the status of the bitmap set on the **Background** tab.

### File

Specifies the name of the bitmap file to be used as the background.

### Select File...

Opens the dialog box to open a file.

Click this button to select a bitmap file (.bmp) to be used as the background.

### Layout Method

Specifies how the background image is to be placed on the paper.

When **Custom** is selected, you can set coordinates for **X-Position** and **Y-Position**.

### Intensity

Adjusts the intensity of the bitmap to be used as a background.

Moving the slider to the right increases the intensity, and moving the slider to the left decreases the intensity. To print the background at the original bitmap intensity, move the slider to the rightmost position.

### ►►► Note

- Depending on the type of printer driver you are using and the environment, this function may not be available.
- Click **Defaults** to set **File** to blank, **Layout Method** to **Fill page**, and the **Intensity** slider to the middle.

## Save settings Tab

The **Save settings** tab allows you to register a new background or delete an unnecessary background.

### Title

Enter the title to save the background image you specified.

Up to 64 characters can be entered.

### ►►► Note

- Spaces, tabs, and returns cannot be entered at the beginning or end of a title.

**Backgrounds**

Shows a list of registered background titles.

Specify a title to display the corresponding background in **Title**.

**Save/Save overwrite**

Saves the image data as a background.

After inserting the **Title**, click this button.

**Delete**

Deletes an unnecessary background.

Specify the title of an unnecessary background from the **Backgrounds** list, and then click this button.

# Maintenance tab Description

The **Maintenance** tab allows you to perform printer maintenance or change the settings of the printer.

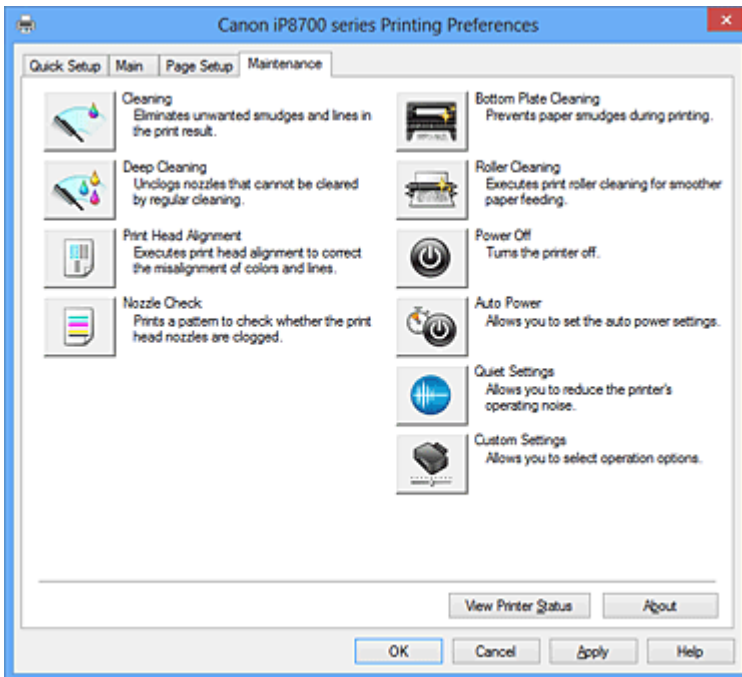

## Cleaning

Performs print head cleaning.

Print head cleaning removes any blockage in the print head nozzles.

Perform cleaning when printing becomes faint, or a specific color fails to print, even though all ink levels are sufficiently high.



## Deep Cleaning

Performs deep cleaning.

Perform deep cleaning when two cleaning attempts do not resolve the print head problem.

### ►►► Note

- **Deep Cleaning** consumes a larger amount of ink than **Cleaning**.  
Cleaning the print heads frequently will rapidly deplete your printer's ink supply. Therefore, perform cleaning only when necessary.

## Ink Group

When you click **Cleaning** or **Deep Cleaning**, the **Ink Group** window is displayed.

Selects the ink group that you want to clean the print head for.

Click [Initial Check Items](#) to display the items that you need to check before you execute cleaning or deep cleaning.

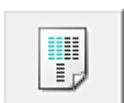

## Print Head Alignment

Print head alignment corrects the installation positions of the print head and improves deviated colors and lines.

Align the print head immediately after installing the print head.

When you click **Print Head Alignment**, the [Start Print Head Alignment dialog box](#) is displayed.



### **Nozzle Check**

Prints a nozzle check pattern.

Perform this function if printing becomes faint or a specific color fails to print. Print a nozzle check pattern, and check whether the print head is working properly. If the print result for a specific color is faded, or if there are any unprinted sections, click **Cleaning** to clean the print head.

To display a list of items that you should check before printing the nozzle check pattern, click [Initial Check Items](#).

### **Print Check Pattern**

This function prints a pattern that allows you to check whether any of the ink nozzles are clogged.

Click **Print Check Pattern**. When the confirmation message is displayed, click **OK**. The **Pattern Check** dialog box is then displayed.

#### **Left-side bitmap (good)**

The print head nozzles are not clogged.

#### **Right-side bitmap (bad)**

The print head nozzles may be clogged.

### **Exit**

Closes the **Pattern Check** dialog box, and returns to the **Maintenance** tab.

### **Cleaning**

Performs print head cleaning.

Print head cleaning removes any blockage in the print head nozzles.

Perform cleaning when printing becomes faint, or if a specific color fails to print, even though all ink levels are sufficiently high.



### **Bottom Plate Cleaning**

Performs cleaning of the bottom plate of the printer.

To prevent smudges on the back side of a sheet of paper, perform **Bottom Plate Cleaning** before you perform duplex printing.

Also perform **Bottom Plate Cleaning** if ink smudges caused by something other than print data appear on the printed page.



### **Roller Cleaning**

Cleans the paper feed rollers.

Paper feeding may fail if paper dust has stuck to the printer's paper feed rollers. In this case, clean the paper feed rollers to improve the print result.



### **Power Off**

Turns off the printer from the printer driver.

Perform this function to turn off the printer when you cannot press the ON button (POWER button) on the printer because the printer is out of your reach.

You must press the ON button (POWER button) on the printer to turn the printer on again after clicking this button. When you use this function, you will not be able to turn the printer on from the printer driver.



### Auto Power

Opens the [Auto Power Settings dialog box](#).

Specify settings for operating the printer power automatically. Perform this function if you want to change the auto power settings.

#### »» Note

- If the printer is off or if communication between the printer and the computer is disabled, an error message may appear because the computer cannot collect the printer status.  
If this happens, click **OK** to display the most recent settings specified on your computer.



### Quiet Settings

Opens the [Quiet Settings dialog box](#).

**Quiet Settings** dialog box allows you to specify a setting that reduces the operating noise of the printer. This mode comes in handy when the operating noise of the printer becomes a concern, such when printing at night. Perform this operation when you want to change the quiet mode setting.

#### »» Note

- If the printer is off or if communication between the printer and the computer is disabled, an error message may appear because the computer cannot collect the printer status.



### Custom Settings

Opens the [Custom Settings dialog box](#).

Perform this function to change the settings of this printer.

#### »» Note

- If the printer is off or bi-directional communication is disabled, a message may appear because the computer cannot collect the printer status.  
If this happens, click **OK** to display the most recent settings specified on your computer.

### View Print History

This function starts the Canon IJ XPS preview, and displays the print history.

#### »» Note

- You can use this function only with the XPS printer driver.

### View Printer Status

Starts the Canon IJ Status Monitor.

Perform this function when you want to check the printer status and how a print job is proceeding.

#### »» Note

- If you are using the XPS printer driver, the "Canon IJ Status Monitor" becomes the "Canon IJ XPS Status Monitor".



## About

Opens the [About dialog box](#).

The version of the printer driver, plus a copyright notice, can be checked.

In addition, the language to be used can be switched.

## Initial Check Items

Check that the printer power is on, and open the cover of the printer.

Check the following items for each ink. Then, if necessary, perform **Nozzle Check** or **Cleaning**.

- [Check the amount of ink](#) remaining in the tank.
- Make sure that you push in the ink tank completely until you hear a clicking sound.
- If an orange tape is adhered to the ink tank, peel it off completely.  
Any remaining tape will hinder ink output.
- Check that the ink tanks are installed in their correct positions.

## Start Print Head Alignment dialog box

This dialog box allows you to adjust the attachment position for the print head, or to print the current setting value for the print head position.

### Align Print Head

Aligns the print head.

Print head alignment corrects the installation positions of the print head and improves deviated colors and lines.

Align the print head immediately after installing the print head.

### Print Alignment Value

Click this button to check the current setting value of the print head position.

Prints the current setting value for the print head position.

## Print Head Alignment dialog box

To adjust the print head position manually, click **Align Print Head** in the **Start Print Head Alignment** dialog box, and perform the operations instructed in the messages. The **Print Head Alignment** dialog box is then displayed.

This dialog box allows you to check the printed pattern and adjust the print head position.

### Preview Window

Displays the pattern of **Print Head Alignment**, and checks the position of the selected pattern.

You can also change the setting by clicking the pattern on the screen directly.

### Select the Pattern Number

Compare the printed adjustment patterns, and enter the pattern number of the pattern with the least visible streaks or horizontal stripes into the corresponding box.

## ►►► Note

- If you do not know how to analyze the printed pattern, see [Aligning the Print Head Position from Your Computer](#).

## Initial Check Items

Check that the printer power is on, and open the cover of the printer.

Check the following items for each ink. Then, if necessary, perform **Nozzle Check** or **Cleaning**.

- [Check the amount of ink](#) remaining in the tank.
- Make sure that you push in the ink tank completely until you hear a clicking sound.
- If an orange tape is adhered to the ink tank, peel it off completely.  
Any remaining tape will hinder ink output.
- Check that the ink tanks are installed in their correct positions.

## Auto Power Settings dialog box

When you click **Auto Power**, the **Auto Power Settings** dialog box is displayed.

This dialog box allows you to manage the printer power from the printer driver.

### Auto Power On

Selects the auto power-on setting.

Specify **Disable** to prevent the printer from turning on automatically when print data is sent to it.

Make sure the printer is on and then click **OK** to change the printer settings.

Specify **Enable** to turn the printer on automatically when print data is sent to it.

### Auto Power Off

Selects the auto power-off setting.

If a printer driver operation or a printer operation is not performed within the specified time, the printer turns off.

## Quiet Settings dialog box

When you click **Quiet Settings**, the **Quiet Settings** dialog box is displayed.

**Quiet Settings** dialog box allows you to specify a setting that reduces the operating noise of the printer.

Select when you wish to reduce the operating noise of the printer at night, etc.

Using this function may lower the print speed.

### Do not use quiet mode

Select this option when you wish to use the printer with volume of normal operating noise.

### Always use quiet mode

Select this option when you wish to reduce the operating noise of the printer.

### Use quiet mode during specified hours

Select this option when you wish to reduce the operating noise of the printer during a specified period of time.

Set the **Start time** and the **End time** of the quiet mode you wish to be activated. If both are set to the same time, the quiet mode will not function.

### Important

- You can set the quiet mode from the printer or the printer driver.  
No matter how you use to set the quiet mode, the mode is applied when you perform operations from the printer or printing from the computer.
- If you specify a time for **Use quiet mode during specified hours**, quiet mode is not applied to operations (direct print, etc.) performed directly from the printer.

## Custom Settings dialog box

When you click **Custom Settings**, the **Custom Settings** dialog box is displayed.

If necessary, switch between various modes of printer operation.

### Detects a printable disc in the disc tray

Detects whether a printable disc is loaded on the disc tray during disc label printing and displays a message if a disc is not loaded.

Check this check box to print with detecting whether a printable disc is loaded.

#### »» Important

- If you leave this check box unchecked, the printer may print to the disc tray even if a printable disc is not loaded on the disc tray. Therefore, you should check this check box under normal circumstances.
- If you load a printable disc that has already been printed onto the disc tray, the printer may detect that no printable disc is loaded on the tray. In this case, uncheck this check box.

### Prevent paper abrasion

The printer can increase the gap between the print head and the paper during high-density printing to prevent paper abrasion.

Check this check box to enable this function.

### Align heads manually

Usually, the **Print Head Alignment** function on the **Maintenance** tab is set to automatic head alignment, but you can change it to manual head alignment.

If the printing results of automatic print head alignment are not satisfactory, [perform manual head alignment](#).

Check this check box to perform the manual head alignment.

### Prevent paper jam

Check this item only if A3 plain paper jams frequently near the paper exit.

#### »» Important

- When this function is used, it takes longer to print to A3 plain paper. Also the print quality may deteriorate.

### Rotate 90 degrees left when orientation is [Landscape]

On the **Page Setup** tab, you can change the rotation direction of the **Landscape** in the **Orientation**. To rotate the document 90 degrees to the left when printing, select the check box.

### Detect the paper width when printing from computer

When you print from the computer, this function identifies the paper that was loaded into this printer. When the paper width detected by the printer differs from the width of the paper specified in **Page Size** on the **Page Setup** tab, a message is displayed.

To use paper width detection when printing from the computer, select the check box.

#### »» Important

- If you are using user-defined paper, use the **Custom Paper Size** to correctly set the size of the paper loaded in the printer. If an error message is displayed even though the same size that was set is loaded, clear the check box.

### Ink Drying Wait Time

The printer can pause before printing a subsequent page. Moving the slider to the right increases the pause time, and moving the slider to the left decreases the time.

If the paper gets stained because the next page is ejected before the ink on the printed page dries, increase the ink drying wait time.

Reducing the ink drying wait time speeds up printing.

## About dialog box

When you click **About**, the **About** dialog box is displayed.

This dialog box displays the version, copyright, and module list of the printer driver. You can select the language to be used and switch the language displayed in the setup window.

### Modules

Lists the printer driver modules.

### Language

Specifies the language you wish to use in the [printer driver setup window](#).

### »»» Important

- If the font for displaying the language of your choice is not installed in your system, the characters will be garbled.

## Related Topics

- ➔ [Cleaning the Print Heads from Your Computer](#)
- ➔ [Aligning the Print Head Position from Your Computer](#)
- ➔ [Use Your Computer to Print a Nozzle Check Pattern](#)
- ➔ [Cleaning Inside the Printer](#)
- ➔ [Cleaning the Paper Feed Rollers from Your Computer](#)
- ➔ [Managing the Printer Power](#)
- ➔ [Reducing the Printer Noise](#)
- ➔ [Changing the Printer Operation Mode](#)

# Canon IJ Preview Description

Canon IJ Preview is an application software that displays what the print result will look like before a document is actually printed.

The preview reflects the information that is set within the printer driver and allows you to check the document layout, print order, and number of pages. You can also change the media type and paper source settings.

When you want to display a preview before printing, open the [printer driver setup window](#), and check the **Preview before printing** check box on the **Main** tab.

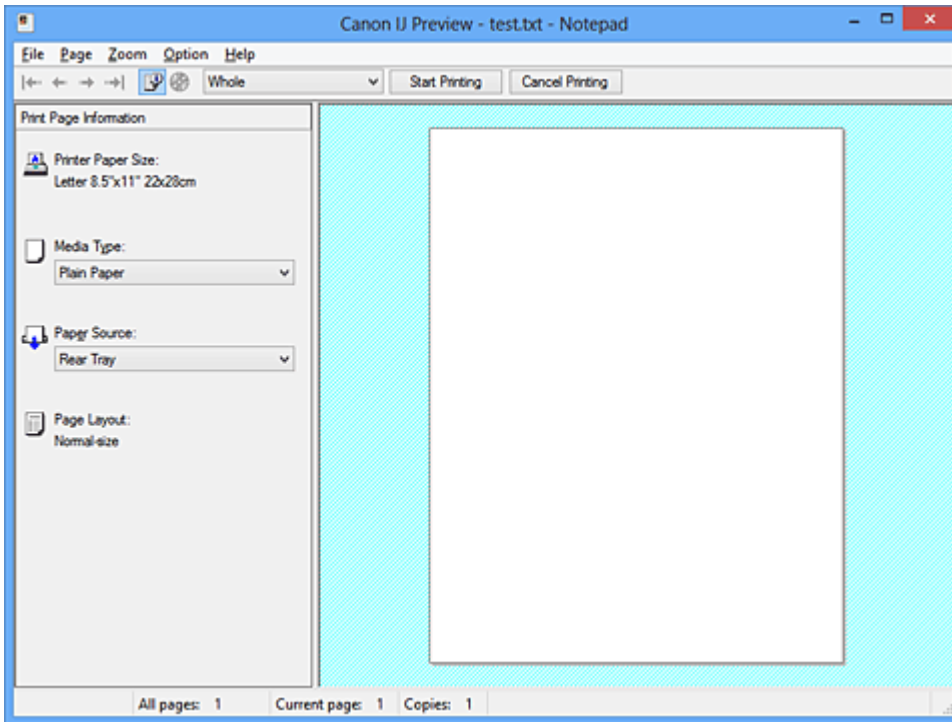

## File Menu

Selects the print operation.

### Start Printing

Ends the Canon IJ Preview and then starts printing the document that is displayed on the preview screen.

This command has the same function as the **Start Printing** on the toolbar.

### Cancel Printing

Ends the Canon IJ Preview and cancels the printing of the document that is displayed on the preview screen.

This command has the same function as the **Cancel Printing** on the toolbar.

### Exit

Ends the Canon IJ Preview.

## Page Menu

This menu includes the following commands to select page to be displayed.

All of these commands except **Page Selection...** can also be selected from the toolbar.

### ►►► Note

- If the pages are being spooled, the last spooled page becomes the last page.
- If the **Page Layout** setting on the **Page Setup** tab is specified to **Page Layout, Tiling/Poster**, or **Booklet**, the number of pages is the number of sheets to be used for printing, and not the number of pages in the original document created with the application software.

- If duplex printing manually has been set, the front pages which will be printed first are all displayed together, and then the back pages are displayed.

### **First Page**

Displays the first page of the document.

If the currently displayed page is the first page, this command is grayed out and cannot be selected.

### **Previous Page**

Displays the page located before the currently displayed page.

If the currently displayed page is the first page, this command is grayed out and cannot be selected.

### **Next Page**

Displays the page located after the currently displayed page.

If the currently displayed page is the last page, this command is grayed out and cannot be selected.

### **Last Page**

Displays the last page of the document.

If the currently displayed page is the last page, this command is grayed out and cannot be selected.

### **Page Selection...**

Displays the **Page Selection** dialog box.

This command allows you to specify the page number of the page to be displayed.

### **Zoom Menu**

Selects the ratio of the actual size printed on the paper to the preview display size.

You can also select the ratio from the drop-down list box located on the toolbar.

#### **Whole**

Displays the entire page of data as one page.

#### **50%**

Reduces the displayed data to 50% of the actual size to be printed.

#### **100%**

Displays the data at the actual size to be printed.

#### **200%**

Enlarges the displayed data to 200% of the actual size to be printed.

#### **400%**

Enlarges the displayed data to 400% of the actual size to be printed.

### **Option Menu**

This menu includes the following command:

#### **Displays Print Page Information**

Displays print setup information (including printer paper size, media type, and page layout) for each page at the left side of the preview screen.

This screen also allows you to change the media type and paper source settings.

### **Help Menu**

When you select this menu item, the Help window for Canon IJ Preview is displayed, and you can check the version and copyright information.

**Start Printing button**

Prints the documents selected in the document list.

The printed documents are deleted from the list, and when all documents are printed, the Canon IJ XPS Preview closes.

**Cancel Printing button**

Ends the Canon IJ Preview, and cancels the printing of the document that is displayed on the preview screen.

You can click this button while spooling.

**Print Page Information Screen**

Displays print setup information for each page at the left side of the preview screen.

This screen also allows you to change the media type and paper source settings.

**»» Important**

- If the media type and paper source are set from the application software, those settings have priority and the changed settings may become ineffective.

**Printer Paper Size**

Displays the paper size of the document to be printed.

**Media Type**

You can select the media type of the document to be printed.

**Paper Source**

You can select the paper source of the document to be printed.

**Page Layout**

Displays the page layout of the document to be printed.

# Canon IJ XPS Preview Description

Canon IJ XPS Preview is an application software that displays what the print result will look like before a document is actually printed.

The preview reflects the information which is set within the printer driver and allows you to check the document layout, print order, and number of pages. The preview also allows you to edit the print document, edit the print pages, change the print settings, and perform other functions.

When you want to display a preview before printing, open the [printer driver setup window](#), and check the **Preview before printing** check box on the **Main** tab.

## ►►► Important

- To use the Canon IJ XPS Preview, you must have Microsoft .NET Framework 4 Client Profile installed on your computer.

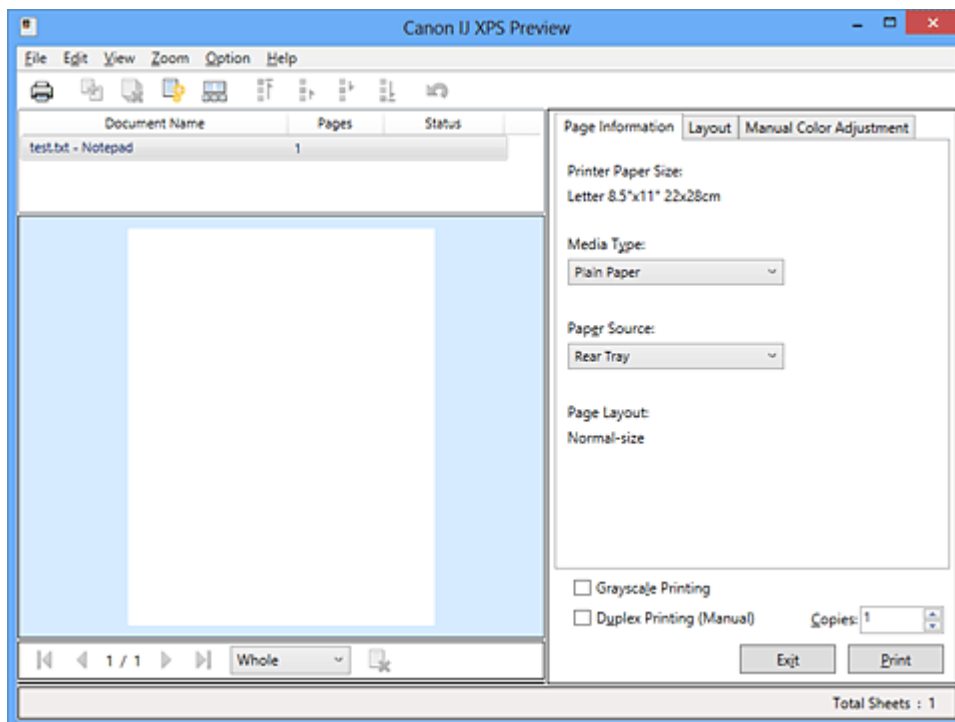

## File Menu

Selects print operation and print history settings:

### Print

Prints the documents selected in the document list.

The printed documents are deleted from the list, and when all documents are printed, the Canon IJ XPS Preview closes.

This command has the same function as  (Print) on the toolbar and the **Print** in the print settings area.

### Print All Documents

Prints all documents in the document list and closes the Canon IJ XPS Preview.

### Save Print History

Switches whether the documents printed from the Canon IJ XPS Preview are to be saved as print history entries.

### History Entry Limit

Switches the maximum number of print history registrations.

Select **10 Entries**, **30 Entries**, or **100 Entries**.



## Important

- If the limit on the number of registration is exceeded, the print history registrations are deleted starting from the oldest one.

### **Add documents from history to the list**

Adds the document saved in the print history to the document list.

### **Exit**

Ends the Canon IJ XPS Preview. The documents remaining in the document list will be deleted from the list.

This command has the same function as the **Exit** in the print settings area.

### **Edit Menu**

Selects the method for editing multiple documents or pages.

#### **Undo**

Reverses the previous change.

If the change cannot be reversed, this function is grayed out and cannot be selected.

This command has the same function as the  (Undo) on the toolbar.

### **Documents**

Selects the method for editing print documents.

#### **Combine Documents**

Combines the documents selected in the document list into one document.

If only one document is selected, this command is grayed out and cannot be selected.

This command has the same function as the  (Combine Documents) on the toolbar.

#### **Reset Documents**

Returns the document selected in the document list to their status before they were added to the Canon IJ XPS Preview.

The combined documents are separated, and the original documents are restored.

This command has the same function as the  (Reset Documents) on the toolbar.

### **Move Document**

Use the following command to change the order of the documents selected in the document list.

#### **Move to First**

Moves the selected print document to the beginning of the document list.

If the currently selected document is the first document, this command is grayed out and cannot be selected.

#### **Move Up One**

Moves the selected print document one up from its current position.

If the currently selected document is the first document, this command is grayed out and cannot be selected.

#### **Move Down One**

Moves the selected print document one down from its current position.

If the currently selected document is the last document, this command is grayed out and cannot be selected.

#### **Move to Last**

Moves the selected print document to the end of the document list.

If the currently selected document is the last document, this command is grayed out and cannot be selected.

### **Delete Document**

Deletes the selected document from the document list.

If the document list contains only one document, the document is grayed out and cannot be selected.

This command has the same function as the  (Delete Document) on the toolbar.

### **Grayscale Printing**

Allows you to change the monochrome print settings.

This command has the same functionality as the **Grayscale Printing** check box in the print settings area.

### **Page Layout Printing...**

Opens the **Page Layout Printing** dialog box.

This dialog box allows you to set **Page Layout Printing**, **Pages**, **Page Order**, and **Page Border**.

### **Duplex Printing...**

Opens the **Duplex Printing** dialog box.

This dialog box allows you to set **Duplex Printing (Manual)**, **Stapling Side**, and **Margin**.

### **Copies...**

Opens the **Copies** dialog box.

This dialog box allows you to set **Copies**, **Collate**, and **Print from Last Page**.

## **Pages**

Selects the method for editing print pages.

### **Delete Page**

Deletes the currently selected page.

If page layout printing is set, the pages enclosed with red frame will be deleted.

This command has the same function as the  (Delete Page) on the toolbar.

### **Restore Page**

Restores pages that were deleted with the **Delete Page** function.

To restore pages, you must select the **View Deleted Pages** check box on the **Option** menu and display the deleted pages as thumbnails.

### **Move Page**

Use the following command to change the order of the currently selected pages.

#### **Move to First**

Moves the currently selected page to the beginning of the document.

If the currently selected page is the first page, this command is grayed out and cannot be selected.

#### **Move Forward One**

Moves the currently selected page one position in front of its current position.

If the currently selected page is the first page, this command is grayed out and cannot be selected.

#### **Move Backward One**

Moves the currently selected page one position after its current position.

If the currently selected page is the last page, this command is grayed out and cannot be selected.

### **Move to Last**

Moves the currently selected page to the end of the document.

If the currently selected page is the last page, this command is grayed out and cannot be selected.

## **View Menu**

Selects the documents and pages to be displayed.

### **Documents**

Use the following command to select the document to display.

#### **First Document**

Displays the first document in the document list.

If the currently selected document is the first document, this command is grayed out and cannot be selected.

#### **Previous Document**

Displays the document located before the currently displayed document.

If the currently selected document is the first document, this command is grayed out and cannot be selected.

#### **Next Document**

Displays the document located after the currently displayed document.

If the currently selected document is the last document, this command is grayed out and cannot be selected.

#### **Last Document**

Displays the last document in the document list.

If the currently selected document is the last document, this command is grayed out and cannot be selected.

## **Pages**

Use the following command to select the page to be displayed.

### **▶▶ Note**

- If the **Page Layout** setting in the printer driver is specified to **Tiling/Poster**, or **Booklet**, the number of pages is the number of sheets to be used for printing, and not the number of pages in the original document created with the application software.

#### **First Page**

Displays the first page of the document.

If the currently displayed page is the first page, this command is grayed out and cannot be selected.

#### **Previous Page**

Displays the page located before the currently displayed page.

If the currently displayed page is the first page, this command is grayed out and cannot be selected.

#### **Next Page**

Displays the page located after the currently displayed page.

If the currently displayed page is the last page, this command is grayed out and cannot be selected.

#### **Last Page**

Displays the last page of the document.

If the currently displayed page is the last page, this command is grayed out and cannot be selected.

### Page Selection...

Displays the **Page Selection** dialog box.

This command allows you to specify the page number of the page to be displayed.

### Zoom Menu

Selects the ratio of the actual size printed on the paper to the preview display size.

You can also select the ratio from the drop-down list box located on the toolbar.

#### Whole

Displays the entire page of data as one page.

#### 50%

Reduces the displayed data to 50% of the actual size to be printed.

#### 100%

Displays the data at the actual size to be printed.

#### 200%

Enlarges the displayed data to 200% of the actual size to be printed.

#### 400%

Enlarges the displayed data to 400% of the actual size to be printed.

### Option Menu

Toggles the show / hide status of the following information.

#### View Thumbnails

Reduces all pages in the document selected in the document list and displays them at the bottom of the preview window.

This command has the same function as the  (View Thumbnails) on the toolbar.

#### View Document List

Displays the print document list at the top of the preview window.

#### View Print Settings Area

Displays the print settings area at the right side of the preview window.

#### View Deleted Pages

When the thumbnails are displayed, this function displays pages that were deleted with the **Delete Page** function.

To check deleted pages, you must first select the **View Thumbnails** check box.

#### Keep printed documents on the list

Leaves the printed document in the document list.

#### Print Settings Displayed at Startup

Switches the tab of the print settings area to be displayed when the Canon IJ XPS Preview is started.

Select **Page Information**, **Layout**, or **Manual Color Adjustment**.

### Help Menu

When you select this menu item, the Help window for Canon IJ XPS Preview is displayed, and you can check the version and copyright information.



#### (Print)

Prints the documents selected in the document list.

The printed documents are deleted from the list, and when all documents are printed, the Canon IJ XPS Preview closes.



### **(Combine Documents)**

Combines the documents selected in the document list into one document.

If only one document is selected, this command is grayed out and cannot be selected.



### **(Delete Document)**

Deletes the selected document from the document list.

If the document list contains only one document, the document is grayed out and cannot be selected.



### **(Reset Documents)**

Returns the document selected in the document list to their status before they were added to the Canon IJ XPS Preview.

The combined documents are separated, and the original documents are restored.



### **(View Thumbnails)**

Reduces all pages in the document selected in the document list and displays them at the bottom of the preview window.

To hide the print pages, click **View Thumbnails** again.



### **(Move to First)**

Moves the selected print document to the beginning of the document list.

If the currently selected document is the first document, this command is grayed out and cannot be selected.



### **(Move Up One)**

Moves the selected print document one up from its current position.

If the currently selected document is the first document, this command is grayed out and cannot be selected.



### **(Move Down One)**

Moves the selected print document one down from its current position.

If the currently selected document is the last document, this command is grayed out and cannot be selected.



### **(Move to Last)**

Moves the selected print document to the end of the document list.

If the currently selected document is the last document, this command is grayed out and cannot be selected.



### **(Undo)**

Reverses the previous change.

If the change cannot be reversed, this function is grayed out and cannot be selected.



### **(Delete Page)**

Deletes the currently selected page.

If page layout printing is set, the pages enclosed with red frame will be deleted.

## **Document list**

Displays the list of the print documents.

The document selected in the document list becomes the target for preview display and editing.

### **Document Name**

Displays the name of the print document.

If you click the name of the selected print document, a text box is displayed, and you can rename the document to any name.

## Pages

Displays the number of pages in the print document.

### »» Important

- The number displayed in **Pages** and the output page count are different.
- To check the output page count, check the status bar at the bottom of the preview window.

## Status

Displays the status of the print documents.

Documents that are undergoing data processing are displayed as **Processing data**.

### »» Important

- Documents showing **Processing data** cannot be printed or edited.  
Wait until the data processing ends.

## Print Settings Area Screen

Allows you to check and change the print settings of the documents selected in the document list.

Print Settings Area is displayed on the right side of the preview window.

### Page Information tab

The print settings are displayed for each page.

You can change the media type and paper source settings.

#### Printer Paper Size

Displays the paper size of the document to be printed.

#### Media Type

Allows you to select the media type of the document to be printed.

#### Paper Source

Allows you to select the paper source of the document to be printed.

#### Page Layout

Displays the page layout of the document to be printed.

### Layout tab

You can specify settings for page layout printing.

To apply the specified settings, click **Apply**.

If the page layout print settings cannot be changed for the print document, the individual items are grayed out and cannot be selected.

### Manual Color Adjustment tab

This tab allows you to adjust the color balance by changing the settings of the **Cyan, Magenta, Yellow, Brightness, Intensity**, and **Contrast** options.

#### Cyan/Magenta/Yellow

Adjusts the strengths of **Cyan, Magenta**, and **Yellow**.

Moving the slider to the right makes a color stronger, and moving the slider to the left makes a color weaker.

You can also directly enter a value linked to the slider. Enter a value in the range from -50 to 50.

This adjustment changes the relative amount of ink of each color used, which alters the total color balance of the document.

Use your application software if you want to change the total color balance significantly. Use the printer driver only if you want to adjust the color balance slightly.

### »» Important

- When **Grayscale Printing** is checked, **Cyan**, **Magenta**, and **Yellow** appear grayed out and are unavailable.

#### Tone

Sets the color adjustment for monochrome printing.

Moving the slider to the right produces warm colors (Warm), and moving the slider to the left produces cool colors (Cool).

You can also directly enter a value linked to the slider. Enter a value in the range from -50 to 50.

### »» Important

- This function is not available for certain **Media Type** settings.

#### Brightness

Selects the brightness of your print.

Pure white and black will not change, but colors between white and black will change.

#### Intensity

Adjusts the overall intensity of your print.

Moving the slider to the right increases the intensity, and moving the slider to the left decreases the intensity.

You can also directly enter a value linked to the slider. Enter a value in the range from -50 to 50.

#### Contrast

Adjusts the contrast between light and dark in the image to be printed.

Moving the slider to the right increases the contrast, moving the slider to the left decreases the contrast.

You can also directly enter a value linked to the slider. Enter a value in the range from -50 to 50.

#### Defaults

Restores all the settings you have changed to their default values.

Clicking this button restores all the settings on this tab to their default values (factory settings).

#### Grayscale Printing

Allows you to change the monochrome print settings.

#### Duplex Printing (Manual)

Select whether to print the document to both sides of the paper manually or to one side of the paper.

If the duplex print settings cannot be changed for the print document, this item is grayed out and is unavailable.

### »» Important

- When you select **Booklet** for **Page Layout**, **Duplex Printing (Manual)** of the print settings area will be set automatically. In this case, **Duplex Printing (Manual)** is grayed out and is unavailable.

#### Copies

Specifies the number of copies you want to print. You can specify a value from 1 to 999.

If the numbers of copies cannot be changed for the print document, this item is grayed out and is unavailable.

**Exit**

Ends the Canon IJ XPS Preview.

The documents remaining in the document list will be deleted from the list.

**Print**

Prints the documents selected in the document list.

The printed documents are deleted from the list, and when all documents are printed, the Canon IJ XPS Preview closes.



# Canon IJ Status Monitor Description

The Canon IJ Status Monitor displays the status of the printer and the printing progress. The monitor uses graphics, icons, and messages to let you know the printer status.

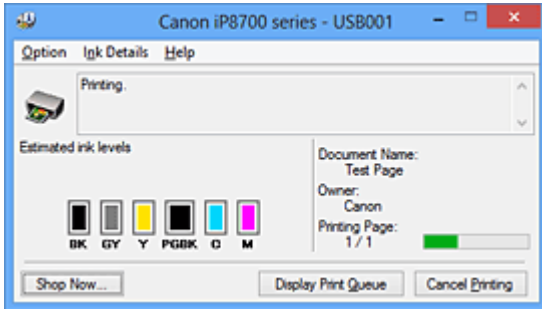

## Canon IJ Status Monitor Features

The Canon IJ Status Monitor offers the following advantages:

**You can check the status of the printer on the screen.**

The status of the printer is shown on the screen in real time.

You can check the printing progress of each printing document (print job).

**Error types and solutions are shown on the screen.**

Shown when a printer error occurs.

You can immediately check how to respond.

**You can check the ink status.**

This function displays graphics showing the ink tank type and the estimated ink levels.

Icons and messages are displayed when ink is running low (ink level warning).

## Canon IJ Status Monitor Overview

Canon IJ Status Monitor allows you to check the status of the printer and ink with graphics and messages.

You can check the information on the printing document and the printing progress during printing.

When a printer error occurs, it shows the cause and solution. Follow the instruction in the message.

### Printer

Canon IJ Status Monitor shows an icon when a warning or error occurs to the printer.

! : Indicates that a warning (operator call error) has occurred or the printer is working.

✖ : There has been an error which requires a service.

### Ink Tank

Canon IJ Status Monitor shows an icon when a low ink warning or a no ink error occurs.

In addition, this function displays graphics showing the estimated ink levels of the ink tank.

In this case, click the graphics to open the **Ink Details** dialog box. You can check the detail information such as the remaining ink level and the ink tank types for your printer.

### Document Name

Shows the name of the document to be printed.

### Owner

Shows the owner's name of the document to be printed.

### Printing Page

Shows the number of printing page and total printing pages.

## Display Print Queue

Shows the print window used to manage the print job that is being printed or being in the print queue.

## Cancel Printing

Cancels the current print job.

### ▶▶▶ Important

- The **Cancel Printing** button is enabled only while print data is being sent to the printer. Once the print data has been sent, the button is grayed out and becomes unavailable.

## Option Menu

If you select **Enable Status Monitor**, when a printer related message is generated the Canon IJ Status Monitor starts.

When **Enable Status Monitor** is selected, following commands are available.

### Always Display Current Job

Displays the Canon IJ Status Monitor during printing.

### Always Display on Top

Displays the Canon IJ Status Monitor in front of other windows.

### Display Guide Message

Displays the guide for operations in which how to set paper is complicated.

#### Envelope Printing

Displays the guide message when envelope printing starts.

To hide this guide message, select the **Do not show this message again** check box.

To display the guide messages again, click **Envelope Printing** on the **Display Guide Message** in the **Option** menu and enable this setting.

#### Hagaki Printing

Displays the guide message before the printer begins hagaki printing.

To hide this guide message, select the **Do not show this message again** check box.

To display the guide messages again, click **Hagaki Printing** on the **Display Guide Message** in the **Option** menu and enable this setting.

### Display Warning Automatically

#### When a Low Ink Warning Occurs

Starts the Canon IJ Status Monitor window automatically and displays it in front of the other windows when a low ink warning occurs.

### Start when Windows is Started

Starts the Canon IJ Status Monitor automatically when you start Windows.

## Ink Details Menu

Select this menu to display the **Ink Details** dialog box. Check the detail information such as the remaining ink level and the ink tank types for your printer.

### Ink Details dialog box

This function displays graphics and messages showing the ink tank type and the estimated ink levels.

#### Ink Information (displayed at left)

Shows the ink tank types with graphics.

If a warning or error related to the remaining ink level occurs, the printer driver displays an icon to let you know.

If the icon is displayed, operate the printer according to the instructions displayed on the screen.

**Message (displayed at right)**

Shows information such as the ink status and ink colors with sentences.

**Ink Model Number**

Shows the ink tank types for your printer.

**Close**

Closes the **Ink Details** dialog box to return to Canon IJ Status Monitor.

**Help Menu**

When you select this menu item, the Help window for Canon IJ Status Monitor is displayed, and you can check the version and copyright information.

## Updating the Printer Driver

- ➔ [Obtaining the Latest Printer Driver](#)
- ➔ [Deleting the Unnecessary Printer Driver](#)
- ➔ [Before Installing the Printer Driver](#)
- ➔ [Installing the Printer Driver](#)

## Obtaining the Latest Printer Driver

By updating the printer driver to the latest version of the printer driver, unresolved problems may be solved.

You can check the version of the printer driver by clicking the **About** button on the **Maintenance** tab.

You can access our website and download the latest printer driver for your model.

### Important

- You can download the printer driver for free, but any Internet access charges incurred are your responsibility.
- Before installing the latest printer driver, [delete the previously installed version](#).

### Related Topics

- ➔ [Before Installing the Printer Driver](#)
- ➔ [Installing the Printer Driver](#)

# Deleting the Unnecessary Printer Driver

The printer driver which you no longer use can be deleted.

When deleting the printer driver, first exit all programs that are running.

The procedure to delete the unnecessary printer driver is as follows:

## 1. Start the uninstaller

- If you are using Windows 8, from the Desktop charms, select **Settings** -> **Control Panel** -> **Programs** -> **Programs and Features**.  
From the program list, select "XXX Printer Driver" (where "XXX" is your model name) and then click **Uninstall**.
- If you are using Windows 7 or Windows Vista, select **Start** menu -> **Control Panel** -> **Programs** -> **Programs and Features**.  
From the program list, select "XXX Printer Driver" (where "XXX" is your model name) and then click **Uninstall**.
- If you are using Windows XP, select **Start** menu -> **Control Panel** -> **Add or Remove Programs**.  
From the program list, select "XXX Printer Driver" (where "XXX" is your model name) and then click **Remove**.

The confirmation window for uninstalling the model appears.

### ▶▶▶ Important

- In Windows 8, Windows 7, or Windows Vista, a confirmation/warning dialog box may appear when starting, installing or uninstalling software.  
This dialog box appears when administrative rights are required to perform a task.  
When you are logged on to an administrator account, click **Yes** (or **Continue**, **Allow**) to continue.  
Some applications require an administrator account to continue. In such cases, switch to an administrator account, and restart the operation from the beginning.

## 2. Execute the uninstaller

Click **Execute**. When the confirmation message appears, click **Yes**.

When all the files have been deleted, click **Complete**.

The deletion of the printer driver is complete.

### ▶▶▶ Important

- Printer driver and XPS printer driver will be deleted when you uninstall the Printer Driver.

## Before Installing the Printer Driver

This section describes the items that you should check before installing the printer driver. You should also refer to this section if the printer driver cannot be installed.

### Checking the Printer Status

- Turn off the printer.

### Checking the Personal Computer Settings

- Terminate all running applications.
- In Windows 8, Windows 7, or Windows Vista, log on as a user who has the administrator account.  
In Windows XP, log on as the computer administrator.

### **»» Important**

- Before installing the latest printer driver, [delete the previously installed version](#).

### Related Topics

- ➔ [Obtaining the Latest Printer Driver](#)
- ➔ [Installing the Printer Driver](#)

# Installing the Printer Driver

You can access our web site through the Internet and download the latest printer driver and XPS printer driver for your model.

The procedure for installing the downloaded printer driver is as follows:

1. Turn off the printer

2. Start the installer

Double-click the icon of the downloaded file.  
The installation program starts.

**»»» Important**

- In Windows 8, Windows 7, or Windows Vista, a confirmation/warning dialog box may appear when starting, installing or uninstalling software.  
This dialog box appears when administrative rights are required to perform a task.  
When you are logged on to an administrator account, click **Yes** (or **Continue, Allow**) to continue.  
Some applications require an administrator account to continue. In such cases, switch to an administrator account, and restart the operation from the beginning.

3. Install the printer driver

Take the appropriate action as described on the screen.

4. Complete the installation

Click **Complete**.

Depending on the environment you are using, a message prompting you to restart the computer may be displayed. To complete the installation properly, restart the computer.

**»»» Important**

- You can install the XPS printer driver with the same procedure for installing the printer driver. However, when installing the XPS printer driver, first complete installation of the printer driver.
- You can download the printer driver and XPS printer driver for free, but any Internet access charges incurred are your responsibility.
- Before installing the latest printer driver, [delete the previously installed version](#).

## Related Topics

- ➔ [Obtaining the Latest Printer Driver](#)
- ➔ [Deleting the Unnecessary Printer Driver](#)
- ➔ [Before Installing the Printer Driver](#)



## Printing from a Digital Camera

- [Printing Photographs Directly from a PictBridge \(Wireless LAN\) Compliant Device](#)
- [About PictBridge \(Wireless LAN\) Print Settings](#)

## Printing Photographs Directly from a PictBridge (Wireless LAN) Compliant Device

You can connect a PictBridge (Wireless LAN) compliant device such as a digital camera, camcorder, or mobile phone to the printer through wireless LAN, and print recorded images directly without using a computer.

### Connectable devices:

PictBridge (Wireless LAN) compliant device

### Printable image data format:

The printer accepts images\* taken with a camera compliant with the Design rule for Camera File system and PNG files.

\* Exif 2.2/2.21/2.3 compliant

### ▶▶▶ Important

- LAN connection with the printer is required to use this function.

### ▶▶▶ Note

- PictBridge is the Standard to print your photos directly without using a computer, connecting a device such as a digital still camera, digital camcorder, or camera-equipped mobile phone.

In this manual, PictBridge printing with the wireless LAN connection is referred to as "PictBridge (Wireless LAN)."

- When printing photos with the PictBridge (Wireless LAN) compliant device connected to the printer, we recommend the use of the AC adapter supplied with the device. If you are using the device battery, be sure to charge it fully.
- Depending on the model or brand of your device, you may have to select a print mode compliant with PictBridge (Wireless LAN) before connecting the device. You may also have to turn on the device or select Play mode manually after connecting the device to the printer.

Perform necessary operations on the PictBridge (Wireless LAN) compliant device before connecting it to this printer according to instructions given in the device's instruction manual.

1. [Make sure that the printer is turned on.](#)
2. [Load paper.](#)
3. Connect the PictBridge (Wireless LAN) compliant device to the printer.

Detect the printer with the PictBridge (Wireless LAN) compliant device and connect the PictBridge (Wireless LAN) compliant device to the printer with wireless LAN.

### ▶▶▶ Note

- For details on how to detect the printer, refer to your PictBridge (Wireless LAN) compliant device's instruction manual.

4. Specify the print settings such as the paper type and layout.

You can perform settings using the menu on the LCD of your PictBridge (Wireless LAN) compliant device. Select the size and type of paper that you loaded in the printer.

➔ [Settings on a PictBridge \(Wireless LAN\) Compliant Device](#)

5. Start printing from your PictBridge (Wireless LAN) compliant device.

# About PictBridge (Wireless LAN) Print Settings

## Settings on a PictBridge (Wireless LAN) Compliant Device

This section describes the PictBridge (Wireless LAN) function of the printer. For the print settings on a PictBridge (Wireless LAN) compliant device, refer to the instructions given in the device's instruction manual.

### ▶▶▶ Note

- In the following description, names of setting items are given according to those used in Canon-brand PictBridge (Wireless LAN) compliant devices. Setting item names may be different depending on the brand or model of your device.
- Some setting items explained below may not be available on some devices. When you cannot change print settings on a device, the printer prints images as follows:

Paper size: 4" x 6"/ 10 x 15 cm

Paper type: Photo

Layout: 1-up, Borderless

Date/File No. Print: Not printed

Image Optimize: The Auto photo fix function will be used for optimized printing.

The following settings can be used when printing from a PictBridge (Wireless LAN) compliant device.

Paper size	4" x 6"/ 10 x 15 cm, 5" x 7"*, 1, 8" x 10"/ 20 x 25 cm, 10" x 12" / 25 x 30 cm, A4, 8.5" x 11"(Letter), A3, A3+/ 13" x 19",  * Can be selected only on certain Canon-brand PictBridge (Wireless LAN) compliant devices. (May not be selected depending on the device.)
Paper type	<ul style="list-style-type: none"> <li>• Default: Photo Paper Plus Glossy II PP-201</li> <li>• Photo: Photo Paper Plus Glossy II PP-201/Photo Stickers* * When printing on sticker paper, select <b>4"x6"/10x15cm</b> in <b>Paper size</b>. Do not set <b>Layout</b> to <b>Borderless</b>.</li> <li>• Fast Photo: Photo Paper Pro Platinum PT-101</li> <li>• Plain: A3, A4/Letter  When <b>Paper type</b> is set to <b>Plain</b>, borderless printing will be disabled even when <b>Layout</b> is set to <b>Borderless</b>.</li> </ul>
Layout	Default (Borderless), Index, Bordered, Borderless, N-up (2, 4, 9, 16)*1, 20-up*2, 35-up*3  *1 Layout compatible with A4 or Letter-sized paper and Canon-brand sticker above. -A4/Letter: 4-up -Photo Stickers: 2-up, 4-up, 9-up, 16-up.  *2 With a Canon brand PictBridge (Wireless LAN) compliant device, selecting items with "i" mark allows you to print shooting info (Exif Data) in list format (20-up) or on the margins of the specified data (1-up). (May not be available with some Canon-brand PictBridge (Wireless LAN) compliant devices.)

	*3 Printed in 35 mm Film Style Layout (Contact Printing Layout). Available only with a Canon-brand PictBridge (Wireless LAN) compliant device. (May not be available with some Canon-brand PictBridge (Wireless LAN) compliant devices.)
Print date & file no.	Default (Off: No printing), Date, File No., Both, Off
Image optimize	<p>Default (Auto photo fix)*1, On (Auto photo fix)*1, Off, Red-Eye*2</p> <p>*1 The scene or person's face of a shot photo is recognized and the most suitable correction for each photo is made automatically. It makes a darkened face by backlight brighter to print. It also analyzes a scene such as scenery, night scene, person, etc. and corrects each scene with the most suitable color, brightness, or contrasts automatically to print.</p> <p>*2 Can be selected only on certain Canon-brand PictBridge (Wireless LAN) compliant devices. (May not be selected depending on the device.)</p>
Trimming	Default (Off: No trimming), On (follow the camera's setting), Off

## **Troubleshooting**

- ▶ **The Printer Cannot Be Powered On**
- ▶ **Printing Does Not Start**
- ▶ **Paper Does Not Feed Properly/"No Paper" Error Occurs**
- ▶ **Print Results Not Satisfactory**
- ▶ **Ink Is Not Ejected**
- ▶ **Paper Jams**
- ▶ **If an Error Occurs**
- ▶ **Cannot Print on the Disc Label**

## **Search Each Function**

- ▶ **Problems with Network Communication**
- ▶ **Problems with Printing**
- ▶ **Problems with Printing Quality**
- ▶ **Problems with the Printer**
- ▶ **Problems with Installation/Downloading**
- ▶ **About Errors/Messages Displayed**
- ▶ **If You Cannot Resolve the Problem**

## **Problems with Network Communication**

- **Problems with the Printer While Using with Network**
- **Cannot Detect a Printer on a Network**
- **Other Problems with Network**

## **Problems with the Printer While Using with Network**

- **The Printer Stopped Working Suddenly**
- **Ink Remaining Level Is Not Displayed on Printer Status Monitor of the Printer**
- **Printing Speed Is Slow**
- **Cannot Use the Printer on Replacing an Access Point or Changing Its settings**



# The Printer Stopped Working Suddenly

- ➔ [Cannot Communicate with the Printer After the Network Settings Are Changed](#)
- ➔ [Cannot Communicate with the Printer over the Wireless LAN](#)
- ➔ [Cannot Print from a Computer Connected to the Network](#)

## Cannot Communicate with the Printer After the Network Settings Are Changed

It may take a while for the computer to obtain the IP address, or you may need to restart your computer. Search for the printer again after confirming a valid IP address is assigned to the computer.

## Cannot Communicate with the Printer over the Wireless LAN

**Check1** Make sure that the printer is turned on.

**Check2** Make sure that the network settings in the printer are identical with those of the access point.

Refer to the instruction manual provided with the access point or contact its manufacturer to check the access point settings, and then modify the printer settings.

- ➔ [How to Set a WEP/WPA/WPA2 Key](#)

**Check3** Make sure that the printer is not placed as far away from the access point.

The access point is located indoors within the effective range for wireless communication. Locate the printer within 164 ft. / 50 m from the access point.

**Check4** Make sure that there is no obstruction.

Wireless communication between different rooms or floors is generally poor. Adjust the location of the devices.

**Check5** Make sure that there is no source of radio wave interference in your vicinity.

If a device (e.g. microwave oven) using the same frequency bandwidth as the wireless station is placed nearby, the device may cause interference. Place the wireless station as far away from the interference source as possible.

**Check6** Make sure that the network settings of the computer are correct.

For the procedures to connect a network device to the computer and set them up, refer to the instruction manual of your network device or contact its manufacturer.

**Check7** Make sure that the radio status is good and adjust the installation positions while monitoring the radio status with IJ Network Tool.

- ➔ [Monitoring Wireless Network Status](#)

**Check8** Make sure that the valid wireless channel is used.

The wireless channel to be used may be limited depending on wireless network devices installed in the computer. Refer to the instruction manual provided with your computer or your wireless network device to specify the valid wireless channel.

**Check9** Make sure that the channel set to the access point is valid to communicate with the computer, confirmed in Check 8.

If not, change the channel set to the access point.

**Check10** Make sure that the firewall of the security software is disabled.

If the firewall function of your security software is turned on, a message may appear warning that Canon software is attempting to access the network. If the warning message appears, set the security software to always allow access.

If using any programs that switch the network environment, check their settings. Some programs will enable a firewall by default.

**Check11** When using a router, connect the printer and computer to the LAN side (same network segment).

If the problem is not resolved, perform setup with the Setup CD-ROM or perform it according to the instructions on our website.

- **For placement:**

Make sure that there is no barrier or obstacle between the access point and the printer.

## Cannot Print from a Computer Connected to the Network

**Check1** Make sure that the network settings of the computer are correct.

For the procedures to set up the computer, refer to the instruction manual of your computer or contact its manufacturer.

**Check2** If the printer driver is not installed, install it.

Install the printer driver with the Setup CD-ROM or install it from our website.

**Check3** Make sure that access control is not set to the access point.

For the procedures to connect an access point and set it up, refer to the instruction manual of your access point or contact its manufacturer.

### ▶▶▶ Note

- To check the MAC address or the IP address of the computer, see [Checking the IP Address or the MAC Address of the Computer](#).

## Ink Remaining Level Is Not Displayed on Printer Status Monitor of the Printer

Use the printer driver with bidirectional communication.

Select **Enable bidirectional support** in the **Ports** sheet of the properties dialog box of the printer driver.

➡ [How to Open the Printer Driver Setup Window](#)

## Printing Speed Is Slow

**Check1** The printer may be printing out a large job issued from another computer.

**Check2** Make sure that the radio status is good and adjust the installation positions while monitoring the radio status with IJ Network Tool.

### ➔ [Monitoring Wireless Network Status](#)

Make sure that there is no barrier or obstacle between the access point and the printer. Wireless communication between different rooms or floors is generally poor. The metal, concrete, or timber including the metallic material, mud wall, or insulator may interrupt a wireless communication. If the printer cannot communicate with the computer over a wireless LAN for the wall material, place the printer and the computer in the same room or floor.

**Check3** Make sure that there is no source of interference in your vicinity.

If a device (e.g. microwave oven) using the same frequency bandwidth as the wireless station is placed nearby, the device may cause interference. Place the wireless station as far away from the interference source as possible.

## Cannot Use the Printer on Replacing an Access Point or Changing Its settings

When you replace an access point, perform network setup of the printer again.

Perform network setup again with the Setup CD-ROM or perform it again according to the instructions on our website.

If the problem is not resolved, see below.

➔ [Cannot Communicate with the Printer After Applying MAC/IP Address Filtering or Entering a WEP/WPA/WPA2 Key to the Access Point](#)

➔ [When Encryption Is Enabled, Cannot Communicate With the Printer After the Encryption Type Was Switched on the Access Point](#)

### Cannot Communicate with the Printer After Applying MAC/IP Address Filtering or Entering a WEP/WPA/WPA2 Key to the Access Point

**Check1** Confirm the access point setting.

Refer to the instruction manual provided with the access point or contact its manufacturer to confirm the access point setting. Make sure that the computer and the access point can communicate with each other under this setting.

**Check2** If you are performing MAC address filtering or IP address filtering at the access point, confirm that the MAC address or IP address for both the computer or the network device and the printer are registered.

**Check3** If you are using a WEP/WPA/WPA2 key, make sure that the key for the computer or the network device and the printer matches that set to the access point.

Besides the WEP key itself, the key length, key format, the key ID to use, and the authentication method must match among the printer, the access point, and the computer.

Normally, select **Auto** for the authentication method. If you want to specify the method manually, select **Open System** or **Shared Key** according to the setting of the access point.

➔ [How to Set a WEP/WPA/WPA2 Key](#)

### When Encryption Is Enabled, Cannot Communicate With the Printer After the Encryption Type Was Switched on the Access Point

If the printer cannot communicate with the computer after the encryption type of the printer was switched, make sure that encryption types for the computer and the access point matches that set to the printer.

➔ [Cannot Communicate with the Printer After Applying MAC/IP Address Filtering or Entering a WEP/WPA/WPA2 Key to the Access Point](#)

## **Cannot Detect a Printer on a Network**

- **Cannot Detect the Printer When Setting up Network Communication**
- **The Printer Cannot Be Detected in the Wireless LAN**

## Cannot Detect the Printer When Setting up Network Communication

If the printer could not be detected on the network when setting up the network communication, confirm the network settings before redetecting the printer.

➡ [Cannot Detect the Printer during Wireless LAN Setup: Check 1](#)

## Cannot Detect the Printer during Wireless LAN Setup: Check 1

**Are the computer and network device (router, access point, etc.) configured and can the computer connect to the network?**

Make sure that you can view web pages on your computer.

### **If you cannot view any web pages:**

Configure the computer and network device.

For the procedures, refer to the instruction manuals supplied with the computer and network device, or contact their manufacturers.

If you can view web pages after configuring the computer and network device, try to set up the network communication from the beginning.

### **If you can view web pages:**

Go to check 2.

➡ [Cannot Detect the Printer during Wireless LAN Setup: Check 2](#)



## Cannot Detect the Printer during Wireless LAN Setup: Check 2

### Does the firewall function of your security software or operation system for computer interfere with setting up the network communication?

The firewall function of your security software or operation system for computer may limit communications between the printer and your computer. Confirm the setting of firewall function of your security software or operation system or the message appearing on your computer.

#### If the firewall function interferes with setting up:

- **When the message appears on your computer:**

If the message warning that Canon software is attempting to access the network appears on the computer, set the security software to allow access.

- **When the message does not appear on your computer:**

Cancel to set up, then set the security software to allow Canon software\* to access the network.

\* On the Setup CD-ROM, select **win > Driver > DrvSetup**, then set the security software to allow the file **Setup.exe** or **Setup64.exe** to access the network.

After setting the security software, try to set up the network communication from the beginning.

#### **Note**

- For the operation system firewall settings or the security software firewall settings, refer to the instruction manual of the computer or software, or contact its manufacturer.

#### If there is no problem with the firewall settings:

Go to check 3.

➡ [Cannot Detect the Printer during Wireless LAN Setup: Check 3](#)

## **Cannot Detect the Printer during Wireless LAN Setup: Check 3**

### **Check the settings of the access point.**

Check the settings of the access point for the network connection such as IP address filtering, MAC address filtering, or DHCP function.

For details on how to check the settings of the access point, refer to the instruction manual supplied with the access point or contact its manufacturer.

## The Printer Cannot Be Detected in the Wireless LAN

**Check1** Make sure that the printer is turned on.

**Check2** Make sure that the Wi-Fi lamp is lit on the front side of the printer.

If Wi-Fi lamp is off, Wireless LAN is inactive.

To activate Wireless LAN, press and hold the **RESUME/CANCEL** button, then release the button when the **POWER** lamp flashes white 10 times.

Wireless LAN is activated and the Wi-Fi lamp is lit.

**Check3** When the printer is connected to the computer temporarily using a USB cable, make sure that the USB cable is connected properly.

When you set up the wireless LAN connection using a USB cable or change the wireless LAN settings using IJ Network Tool, connect the printer and the computer securely.

➔ [Connecting the Printer to the Computer Using a USB Cable](#)

**Check4** Make sure that the printer setup is completed.

If not, perform setup with the Setup CD-ROM or perform it according to the instructions on our website.

**Check5** When using IJ Network Tool, click **Update** to search for the printer again.

➔ [Canon IJ Network Tool Screen](#)

**Check6** When searching for a printer over a network, make sure that the printer is associated with the port.

When **No Driver** is displayed under **Name** in IJ Network Tool, there is no association. Select **Associate Port** on the **Settings** menu, then associate the port with the printer.

➔ [When the Printer Driver Is Not Associated with a Port](#)

**Check7** Make sure that the network settings in the printer are identical with those of the access point.

Refer to the instruction manual provided with the access point or contact its manufacturer to check the access point settings, and then modify the printer settings.

➔ [How to Set a WEP/WPA/WPA2 Key](#)

**Check8** Make sure that there is no obstruction.

Wireless communication between different rooms or floors is generally poor. Adjust the location of the devices.

**Check9** Make sure that the printer is not placed as far away from the access point.

The access point is located indoors within the effective range for wireless communication. Locate the printer within 164 ft. / 50 m from the access point.

**Check10** Make sure that there is no source of radio wave interference in your vicinity.

If a device (e.g. microwave oven) using the same frequency bandwidth as the wireless station is placed nearby, the device may cause interference. Place the wireless station as far away from the interference source as possible.

**Check11** Make sure that the network settings of the computer are correct.

Make sure that the computer can communicate with the printer and the access point over the wireless LAN.

**Check12** Make sure that **Enable bidirectional support** is selected in the **Ports** sheet of the properties dialog box of the printer driver.

**Check13** Make sure that the firewall of the security software is disabled.

If the firewall function of your security software is turned on, a message may appear warning that Canon software is attempting to access the network. If the warning message appears, set the security software to always allow access.

If using any programs that switch the network environment, check their settings. Some programs will enable a firewall by default.

**Check14** When using a router, connect the printer and computer to the LAN side (same network segment).

If the problem is not resolved, perform setup with the Setup CD-ROM or perform it according to the instructions on our website.

## **Other Problems with Network**

- ▶ **Forgot an Access Point Name, SSID, or a Network Key**
- ▶ **The Message Is Displayed on the Computer Screen During Setup**
- ▶ **The Admin Password Set to the Printer Was Forgotten**
- ▶ **Checking Information about the Network**
- ▶ **How to Restore the Printer's Network Settings to Factory Default**

## Forgot an Access Point Name, SSID, or a Network Key

➔ [Cannot Connect with an Access Point to Which a WEP/WPA/WPA2 Key Is Set \(You Forgot the WEP/WPA/WPA2 Key\)](#)

➔ [How to Set a WEP/WPA/WPA2 Key](#)

### Cannot Connect with an Access Point to Which a WEP/WPA/WPA2 Key Is Set (You Forgot the WEP/WPA/WPA2 Key)

For information on how to set up the access point, refer to the instruction manual provided with the access point or contact its manufacturer. Make sure that the computer and the access point can communicate with each other.

After that, set up the printer to match the settings of the access point using IJ Network Tool.

### How to Set a WEP/WPA/WPA2 Key

For information on how to set up the access point, refer to the instruction manual provided with the access point or contact its manufacturer. Make sure that the computer and the access point can communicate with each other.

After that, set up the printer to match the settings of the access point using IJ Network Tool.

- **When using WEP**

The key length, key format, the key to use (one of 1 to 4), and the authentication method must match among the access point, the printer, and the computer.

In order to communicate with an access point that uses automatically generated WEP keys, you must configure the printer to use the key generated by the access point by entering it in hexadecimal format.

Normally, select **Auto** for the authentication method. Otherwise, select **Open System** or **Shared Key** according to the setting of the access point.

When the **WEP Details** screen appears after clicking **Set** on the **Search** screen, follow the on-screen instructions and set the key length, the key format, the key number, and the authentication to enter a WEP key.

For details, see [Changing the WEP Detailed Settings](#).

- **When using WPA or WPA2**

The authentication method, passphrase, and dynamic encryption type must match on the access point, the printer, and the computer.

Enter the passphrase configured on the access point (a sequence of between 8 and 63 alphanumeric characters, or a 64-character hexadecimal number).

Select either **TKIP (Basic Encryption)** or **AES (Secure Encryption)** for the dynamic encryption method.

For details, see [Changing the WPA or WPA2 Detailed Settings](#).

#### ▶▶▶ Note

- This printer supports WPA-PSK (WPA-Personal) and WPA2-PSK (WPA2-Personal).

## The Message Is Displayed on the Computer Screen During Setup

- ➔ [The Enter Password Screen Is Displayed During Setup](#)
- ➔ [The Screen for Setting the Encryption Is Displayed After Selecting the Access Point in the Search Screen](#)
- ➔ ["You are connecting the printer to the non encrypted wireless network" Is Displayed](#)

### The Enter Password Screen Is Displayed During Setup

The following screen is displayed if an administrator password is set to the printer which has already been set up.



Enter the administrator password you have set.

- ➔ [Changing the Settings in the Admin Password Sheet](#)

### The Screen for Setting the Encryption Is Displayed After Selecting the Access Point in the Search Screen

This screen is displayed automatically if the selected access point is encrypted. In this case, configure the details to use the same encryption settings set to the access point.

For information on the encryption settings, see [Changing the Settings in the Wireless LAN Sheet](#).

### "You are connecting the printer to the non encrypted wireless network" Is Displayed

Security is not configured on the access point. The printer can still be used, so continue the setup procedure to complete it.

#### ➔➔➔ Important

- If you connect to a network that is not protected with security measures, there is a risk of disclosing data such as your personal information to a third party.

## The Admin Password Set to the Printer Was Forgotten

Initialize the LAN settings.

➡ [How to Restore the Printer's Network Settings to Factory Default](#)

After initializing the LAN settings, perform setup with the Setup CD-ROM or perform it according to the instructions on our website.



# Checking Information about the Network

- ➔ [Checking the IP Address or the MAC Address of the Printer](#)
- ➔ [Checking the IP Address or the MAC Address of the Computer](#)
- ➔ [Checking If the Computer and the Printer, or Computer and the Access Point Can Communicate](#)
- ➔ [Checking the Network Setting Information](#)

## Checking the IP Address or the MAC Address of the Printer

To check the IP address or the MAC address of the printer, print out the network setting information.

- ➔ [Printing Out Network Setting Information](#)

To display the network setting information using IJ Network Tool, select **Network Information** on the **View** menu.

- ➔ [Canon IJ Network Tool Screen](#)

## Checking the IP Address or the MAC Address of the Computer

To check the IP address or MAC address assigned to the computer, follow the procedure below.

1. Select **Command Prompt** as shown below.
  - In Windows 8, select **Command Prompt** from the **Start** screen. If **Command Prompt** is not displayed on the **Start** screen, select the **Search** charm, then search for "**Command Prompt**".
  - In Windows 7, Windows Vista, or Windows XP, click **Start > All Programs > Accessories > Command Prompt**.

2. Enter "ipconfig/all" and press the **Enter** key.

The IP addresses and the MAC addresses of the network devices installed on your computer are displayed. When the network device is not connected to the network, the IP address is not displayed.

## Checking If the Computer and the Printer, or Computer and the Access Point Can Communicate

To check that communication is available, perform the ping test.

1. Select **Command Prompt** as shown below.
  - In Windows 8, select **Command Prompt** from the **Start** screen. If **Command Prompt** is not displayed on the **Start** screen, select the **Search** charm, then search for "**Command Prompt**".
  - In Windows 7, Windows Vista, or Windows XP, click **Start > All Programs > Accessories > Command Prompt**.
2. Type the ping command and the IP address of the target printer or the target access point, and then press the **Enter** key.

```
ping XXX.XXX.XXX.XXX
```

"XXX.XXX.XXX.XXX" is the IP address of the target device.

If the communication is available, a message such as the following is displayed.

Reply from XXX.XXX.XXX.XXX: bytes=32 time=10ms TTL=255

When **Request timed out** is displayed, the communication is not available.

## Checking the Network Setting Information

To check the IP address or the MAC address of the printer, print out the network setting information.

➡ [Printing Out Network Setting Information](#)

# How to Restore the Printer's Network Settings to Factory Default

## Important

- Note that initialization erases all network settings on the printer, and printing operation from a computer over network may become impossible. To use the printer over network, perform setup with the Setup CD-ROM or perform it according to the instructions on our website.

Press and hold the **RESUME/CANCEL** button, then release the button when the **POWER** lamp flashes white 9 times.

The network settings are initialized.

## **Problems with Printing**

- **Printing Does Not Start**
- **Paper Jams**
- **Paper Does Not Feed Properly/"No Paper" Error Occurs**
- **Cannot Print on the Disc Label**
- **Printing Stops Before It Is Completed**

# Printing Does Not Start

**Check1** Make sure that the power plug is securely plugged in, then press the **ON** button to turn the printer on.

While the **POWER** lamp is flashing, the printer is initializing. Wait until the **POWER** lamp stops flashing and remains lit.

## ▶▶▶ Note

- When printing large data such as a photo or graphics, it may take longer to start printing. While the **POWER** lamp is flashing, the computer is processing data and sending it to the printer. Wait until printing starts.

**Check2** Make sure that the printer is connected to your computer properly.

When the printer is connected to your computer with a USB cable, make sure that the USB cable is securely plugged in to the printer and the computer, then check the followings:

- If you are using a relay device such as a USB hub, disconnect it, connect the printer directly to the computer, and try printing again. If printing starts normally, there is a problem with the relay device. Consult the reseller of the relay device for details.
- There could also be a problem with the USB cable. Replace the USB cable and try printing again.

When you use the printer over LAN, make sure that the printer is set up to be used over network correctly.

**Check3** If there are any unnecessary print jobs, delete them.

➔ [Deleting the Undesired Print Job](#)

**Check4** Make sure that the disc tray guide is closed.

If the disc tray guide is opened, close the disc tray guide and press the **RESUME/CANCEL** button on the printer.

**Check5** Does the page size setting match the size of the paper loaded in the printer?

Set the printer not to detect the width of the paper using the printer driver.

To set the printer not to detect the width of the paper, open the printer driver setup window, and in **Custom Settings** under the **Maintenance** sheet, clear the **Detect the paper width when printing from computer** check box, and then click **OK**.

To open the printer driver setup window, see [How to Open the Printer Driver Setup Window](#).

\* Select the **Detect the paper width when printing from computer** check box again once printing is complete, and then click **OK**.

**Check6** Are the Media Type and the Page Size settings of the printer driver correct?

When using non Canon genuine specialty paper, be sure to select the proper media type or page size correctly in the printer driver.

Confirm the settings following the procedure below, and try printing again.

1. Make sure that **A3 (Art Paper Margin 35)**, **A3+ (Art Paper Margin 35)**, **A4 (Art Paper Margin 35)**, or **Letter (Art Paper Margin 35)** is selected in the application.

If the page size you want to use is not displayed, open the **File** menu of the application and select **Print**. Then make sure that the name of your printer is selected.

2. Make sure that the paper selected for **Media Type** in the **Main** sheet in the printer driver matches the paper loaded in the printer.
3. Make sure that the **Page Size** setting in the **Page Setup** sheet in the printer driver is the same as the size set in step 1.

**Check7** Make sure that your printer's name is selected in the Print dialog box.

The printer will not print properly if you are using a printer driver for a different printer.

Make sure that your printer's name is selected in the Print dialog box.

### ▶▶▶ Note

- To make the printer the one selected by default, select **Set as Default Printer**.

**Check8** Configure the printer port appropriately.

Make sure that the printer port is configured appropriately.

1. Log on as a user account with administrator privilege.
2. Select items as shown below.
  - In Windows 8, select **Control Panel** from the **Settings** charm on **Desktop > Hardware and Sound > Devices and Printers**.
  - In Windows 7, select **Devices and Printers** from the **Start** menu.
  - In Windows Vista, select the **Start** menu > **Control Panel > Hardware and Sound > Printers**.
  - In Windows XP, select the **Start** menu > **Control Panel > Printers and Other Hardware > Printers and Faxes**.
3. Open the properties of the printer driver for the printer.
  - In Windows 8 or Windows 7, right-click the "Canon XXX" icon (where "XXX" is your printer's name), then select **Printer properties**.
  - In Windows Vista or Windows XP, right-click the "Canon XXX" icon (where "XXX" is your printer's name), then select **Properties**.
4. Click the **Ports** tab to confirm the port settings.

Make sure that a port named "USBnnn" (where "n" is a number) with "Canon XXX" appearing in the **Printer** column is selected for **Print to the following port(s)**.

### ▶▶▶ Note

- When the printer is used over LAN, the port name of the printer is displayed as "CNBJNP\_XXXXXXXX". "XXXXXXXX" is the character string generated from the MAC address or a character string specified by the user when setting up the printer.

- If the setting is incorrect:

Reinstall the printer driver with the Setup CD-ROM or install it from our website.

- Printing does not start even though the printer is connected to the computer using a USB cable and the port named "USBnnn" is selected:

In Windows 8, select **My Printer** on the **Start** screen to start **My Printer**. If **My Printer** is not displayed on the **Start** screen, select the **Search** charm, then search for "**My Printer**".

Set the correct printer port on **Diagnose and Repair Printer**. Follow the on-screen instructions to set the correct printer port, then select your printer's name.

In Windows 7, Windows Vista, or Windows XP, click **Start** and select **All programs**, Canon Utilities, **Canon My Printer**, **Canon My Printer**, then select **Diagnose and Repair Printer**. Follow the on-screen instructions to set the correct printer port, then select your printer's name.

If the problem is not resolved, reinstall the printer driver with the Setup CD-ROM or install it from our website.

- Printing does not start even though the port named "CNBJNP\_XXXXXXXX" is selected when the printer is used over LAN:

Launch IJ Network Tool, and select "CNBJNP\_XXXXXXXX" as you confirmed in step 4, then associate the port with the printer using **Associate Port** in the **Settings** menu.

If the problem is not resolved, reinstall the printer driver with the Setup CD-ROM or install it from our website.

#### **Check9** Is the size of the print data extremely large?

Click **Print Options** on the **Page Setup** sheet on the printer driver. Then, set **Prevention of Print Data Loss** in the displayed dialog to **On**.

\* When **On** is selected for **Prevention of Print Data Loss**, print quality may be reduced.

#### **Check10** Restart your computer.

## Paper Jams

When paper is jammed, the **Alarm** lamp flashes orange and a troubleshooting message is displayed on the computer screen automatically. Take the appropriate action described in the message.

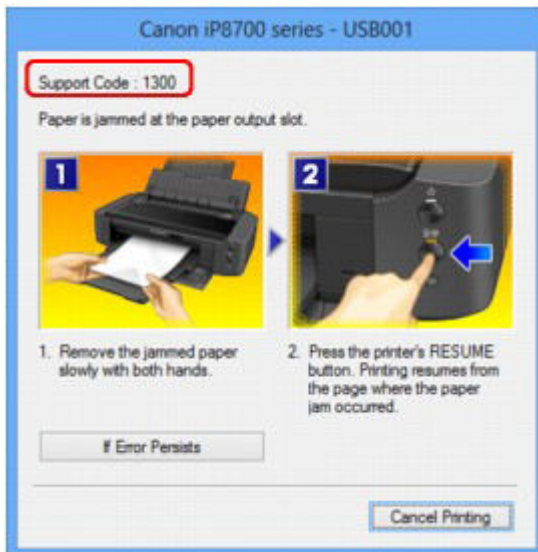

For details on how to remove the jammed paper, refer to [Support Code List \(When Paper Is Jammed\)](#).

### ►► Note

- You can confirm the actions against errors with Support Codes on your computer by searching a Support Code.

➡ [Click Here to Search](#)



# Paper Does Not Feed Properly/"No Paper" Error Occurs

**Check1** Make sure that paper is loaded.

➔ [Loading Paper](#)

**Check2** Make sure of the following when you load paper.

- When loading two or more sheets of paper, flip through the paper before loading.



- When loading two or more sheets of paper, align the edges of the sheets before loading.
- When loading two or more sheets of paper, make sure that the paper stack does not exceed the paper load limit.

However, proper feeding of paper may not be possible at this maximum capacity depending on the type of paper or environmental conditions (either very high or low temperature and humidity). In such cases, reduce the sheets of paper you load at a time to less than half of the paper load limit.

- Always load the paper in portrait orientation, regardless of the printing orientation.
- When you load the paper, load the paper with the print side facing UP and slide the paper guides to align with the both sides of the paper.

➔ [Loading Paper](#)

**Check3** Check to see if the paper you are printing on is not too thick or curled.

➔ [Media Types You Cannot Use](#)

**Check4** Make sure of the following when you load Hagakis or envelopes.

- If a Hagaki is curled, it may not feed properly even though the paper stack does not exceed the paper load limit.
- When printing on envelopes, refer to [Loading Paper](#), and prepare the envelopes before printing.

Once you have prepared the envelopes, load them in portrait orientation. If the envelopes are placed in landscape orientation, they will not feed properly.

**Check5** Confirm that the media type and the paper size settings correspond with the loaded paper.

**Check6** Make sure that there are not any foreign objects in the rear tray.



If the paper tears in the rear tray, see [Paper Jams](#) to remove it.

If there are any foreign objects in the rear tray, be sure to turn off the printer, unplug it from the power supply, then remove the foreign object.



**Check7** Make sure that the disc tray guide is closed completely.

Paper does not feed properly if the disc tray guide is even slightly open.

➔ [Placing a Printable Disc](#)

**Check8** Clean the paper feed roller.

➔ [Cleaning the Paper Feed Rollers from Your Computer](#)

### ➔➔➔ Note

- Cleaning the paper feed roller will wear the roller, so perform this procedure only when necessary.

**Check9** If A3 sized plain paper jams frequently near the paper output slot or is curled, apply the setting to prevent paper jam.

Only when A3 sized plain paper jams frequently near the paper output slot or is curled, set the printer to prevent paper jam with the printer driver.

Print speed or print quality may be reduced if you apply the setting to prevent paper jam.

\* Readjust the setting not to prevent paper jam once printing is complete. If not, this setting remains enabled for all subsequent print jobs.

Open the printer driver setup window, and in **Custom Settings** in the **Maintenance** sheet, select the **Prevent paper jam** check box, and then click **OK**.

To open the printer driver setup window, see [How to Open the Printer Driver Setup Window](#).

## Cannot Print on the Disc Label

➔ [Disc Label Printing Does Not Start](#)

➔ [Disc Tray Does Not Feed Properly](#)

➔ [Disc Tray Jammed](#)

### Disc Label Printing Does Not Start

#### Check1 Is the disc tray placed properly?

Open the disc tray guide, properly place the disc tray again, then press the **RESUME/CANCEL** button on the printer.

Use the disc tray supplied with this printer ("L" is on the upper side).

For details on how to place the disc tray, refer to [Placing a Printable Disc](#).

#### Check2 Is the printable disc placed on the disc tray?

Place the printable disc on the disc tray properly, then press the **RESUME/CANCEL** button.

Use the disc tray supplied with this printer ("L" is on the upper side).

For details on how to place the disc tray, refer to [Placing a Printable Disc](#).

#### Check3 If disc label printing stops before it is complete, try the operation again.

If a certain period of time has elapsed while disc label printing is in progress, the printer stops initializing.

The printer resumes initializing by pressing the **RESUME/CANCEL** button.

Try the operation again following the on-screen instructions.

### Disc Tray Does Not Feed Properly

#### Check1 Is the disc tray placed properly?

Properly place the disc tray again, then press the **RESUME/CANCEL** button.

Use the disc tray supplied with this printer ("L" is on the upper side).

For details on how to place the disc tray, refer to [Placing a Printable Disc](#).

#### Check2 Unrecognizable printable disc may be placed.

Canon recommends that you use printable discs specially processed to be printed on by an inkjet printer.

### Disc Tray Jammed

Pull out the disc tray gently.

If the disc tray cannot be pulled out, turn the printer off, then turn the printer back on again. The disc tray will automatically be ejected.

When the disc tray is pulled out, place the disc tray ("L" is on the upper side) again, then retry printing.

Place the printable disc properly referring to [Placing a Printable Disc](#).

If the disc tray is still jammed, check if there is a problem with the printable disc.

➔ [Disc Tray Does Not Feed Properly](#)

# Printing Stops Before It Is Completed

**Check1** Is the disc tray guide opened while printing on paper?

Close the disc tray guide and press the **RESUME/CANCEL** button on the printer.

**Check2** Is the paper loaded?

Make sure that paper is loaded.

If the printer has run out of paper, load paper.

**Check3** Do the printing documents have lots of photographs or illustrations?

As printing large data such as photos or graphics takes time for the printer and the computer to process, the printer may appear to have stopped operating.

In addition, when printing data that uses a large amount of ink continuously on plain paper, the printer may pause temporarily. In either case, wait until the process is complete.

## ▶▶▶ Note

- If you are printing a document with a large printing area or printing multiple copies of a document, printing may pause to allow the ink to dry.

**Check4** Has the printer been printing continuously for a long period?

If the printer has been printing continuously for a long time, the print head or other parts around it may overheat. The printer may stop printing at a line break for a period of time and then resume printing.

In this case, wait for a while without operation. If the printing still does not resume, interrupt your print session at a convenient time and turn the printer off for at least 15 minutes.

## ⚠ Caution

- The print head and the surrounding area can become extremely hot inside the printer. Never touch the print head or nearby components.

## **Problems with Printing Quality**

- ▶ **Print Results Not Satisfactory**
- ▶ **Ink Is Not Ejected**

## Print Results Not Satisfactory

If the print result is not satisfactory due to white streaks, misaligned lines, or uneven colors, confirm the paper and print quality settings first.

### Check1 Do the page size and media type settings match the size and type of the loaded paper?

When these settings are incorrect, you cannot obtain a proper print result.

If you are printing a photograph or an illustration, incorrect paper type settings may reduce the quality of the printout color.

Also, if you print with an incorrect paper type setting, the printed surface may be scratched.

In borderless printing, uneven coloring may occur depending on the combination of the paper type setting and the loaded paper.

The method of confirming the paper and print quality settings differs depending on what you do with your printer.

To print from a PictBridge (Wireless LAN) compliant device	Confirm by using your PictBridge (Wireless LAN) compliant device. ➔ <a href="#">About PictBridge (Wireless LAN) Print Settings</a>
To print from a computer	Confirm by using the printer driver. ➔ <a href="#">Printing with Easy Setup</a>

### Check2 Make sure that the appropriate print quality is selected referring to the table in Check 1.

Select a print quality option suitable for the paper and image for printing. If you notice blurs or uneven colors, increase the print quality setting and try printing again.

#### ▶▶▶ Note

- You cannot make this setting from a PictBridge (Wireless LAN) compliant device.

### Check3 If the problem is not resolved, there may be other causes.

See also the sections below:

- ➔ [Cannot Print to End of Job](#)
- ➔ [No Printing Results/Printing Is Blurred/Colors Are Wrong/White Streaks](#)
- ➔ [Lines Are Misaligned](#)
- ➔ [Line Does Not Print or Prints Partially](#)
- ➔ [Image Does Not Print or Prints Partially](#)
- ➔ [Printed Paper Curls or Has Ink Blots](#)
- ➔ [Paper Is Smudged/Printed Surface Is Scratched](#)
- ➔ [Back of the Paper Is Smudged](#)
- ➔ [Vertical Lines Are Printed on the Sides of the Printout](#)
- ➔ [Colors Are Uneven or Streaked](#)

## Cannot Print to End of Job

**Check1** Select the setting not to compress the printing data.

If you select the setting not to compress the printing data with an application software you are using, the printing result may be improved.

Click **Print Options** on the **Page Setup** sheet on the printer driver. Select the **Do not allow application software to compress print data** check box, then click **OK**.

\* Deselect the check box after printing is complete.

**Check2** Is the size of the print data extremely large?

Click **Print Options** on the **Page Setup** sheet on the printer driver. Then, set **Prevention of Print Data Loss** in the displayed dialog to **On**.

\* When **On** is selected for **Prevention of Print Data Loss**, print quality may be reduced.

**Check3** Is the space of your computer's hard disk sufficient?

Delete unnecessary files to free disk space.



# No Printing Results/Printing Is Blurred/Colors Are Wrong/White Streaks

❖ No Printing Results



❖ Printing Is Blurred



❖ Colors Are Wrong



❖ White Streaks

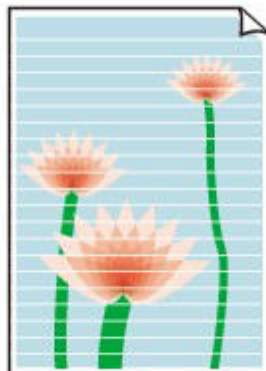

**Check1** Did you confirm the paper and print quality settings?

➔ [Print Results Not Satisfactory](#)

**Check2** Check the status of ink tanks. Replace the ink tank if the ink has run out.

➔ [Replacing an Ink Tank](#)

**Check3** Is the orange tape or protective film remaining?

Make sure that all of the protective film is peeled off and the Y-shape air hole is exposed, as illustrated in (A).

If the orange tape is left as in (B), pull the orange tape and remove it.

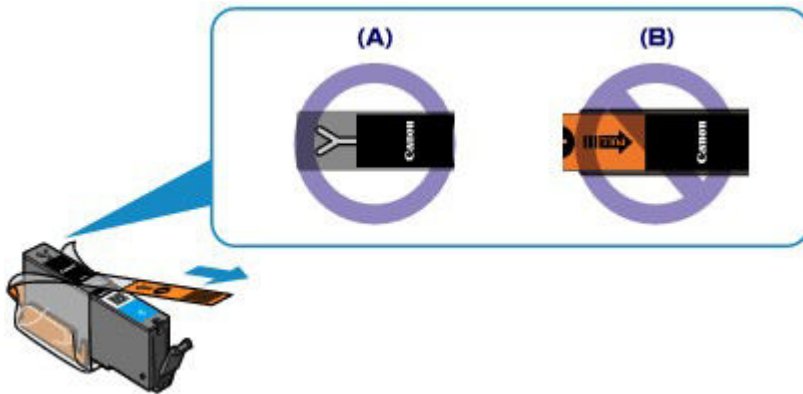

**Check4** Print the Nozzle Check Pattern and perform any necessary maintenance operations such as Print Head Cleaning.

Print the Nozzle Check Pattern to determine whether the ink ejects properly from the print head nozzles.

Refer to [When Printing Becomes Faint or Colors Are Incorrect](#) for the Nozzle Check Pattern printing, Print Head Cleaning, and Print Head Deep Cleaning.

- If the Nozzle Check Pattern is not printed correctly:  
Check to see if a particular color's ink tank is not empty.  
If the Nozzle Check Pattern is not printed correctly though ink is sufficient, perform the Print Head Cleaning and try printing the Nozzle Check Pattern again.
- If the problem is not resolved after performing the Print Head Cleaning twice:  
Perform the Print Head Deep Cleaning.  
If the problem is not resolved after performing the Print Head Deep Cleaning, turn off the printer and perform another Print Head Deep Cleaning after 24 hours.
- If the problem is not resolved after performing the Print Head Deep Cleaning twice:  
If Print Head Deep Cleaning does not resolve the problem, the print head may be damaged. Contact the service center.

**Check5** When using paper with one printable surface, make sure that the paper is loaded with the printable side facing up.

Printing on the wrong side of such paper may cause unclear prints or prints with reduced quality.

Load paper with the printable side facing up.

Refer to the instruction manual supplied with the paper for detailed information on the printable side.

## Lines Are Misaligned



**Check1** Did you confirm the paper and print quality settings?

➔ [Print Results Not Satisfactory](#)

**Check2** Perform Print Head Alignment.

If printed lines are misaligned or print results are otherwise unsatisfactory, adjust the print head position.

➔ [Aligning the Print Head](#)

### ➔➔➔ Note

- If the problem is not resolved after performing the Print Head Alignment, perform Print Head Alignment manually referring to [Aligning the Print Head Position Manually from Your Computer](#).

**Check3** Increase the print quality and try printing again.

Increasing the print quality in the printer driver may improve the print result.

## Line Does Not Print or Prints Partially

**Check1** Is the Page Layout Printing performed or the Binding margin function used?

When the Page Layout Printing or Binding margin function is being used, thin lines may not be printed. Try thickening the lines in the document.

**Check2** Is the size of the print data extremely large?

Click **Print Options** on the **Page Setup** sheet on the printer driver. Then, set **Prevention of Print Data Loss** in the displayed dialog to **On**.

\* When **On** is selected for **Prevention of Print Data Loss**, print quality may be reduced.

## Image Does Not Print or Prints Partially

**Check1** Select the setting not to compress the printing data.

If you select the setting not to compress the printing data with an application software you are using, the printing result may be improved.

Click **Print Options** on the **Page Setup** sheet on the printer driver. Select the **Do not allow application software to compress print data** check box, then click **OK**.

\* Deselect the check box after printing is complete.

**Check2** Is the size of the print data extremely large?

Click **Print Options** on the **Page Setup** sheet on the printer driver. Then, set **Prevention of Print Data Loss** in the displayed dialog to **On**.

\* When **On** is selected for **Prevention of Print Data Loss**, print quality may be reduced.

# Printed Paper Curls or Has Ink Blots

## Printed Paper Has Ink Blots



## Printed Paper Curls

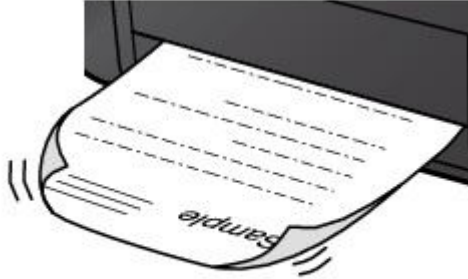

**Check1** Did you confirm the paper and print quality settings?

➔ [Print Results Not Satisfactory](#)

**Check2** If the intensity is set high, reduce the intensity setting and try printing again.

If you are using plain paper to print images with high intensity, the paper may absorb too much ink and become wavy, causing paper abrasion.

You can confirm the intensity using the printer driver.

➔ [Adjusting Intensity](#)

**Check3** Is Photo Paper used for printing photographs?

When printing data with high color saturation such as photographs or images in deep color, we recommend using Photo Paper Plus Glossy II or other Canon speciality paper.

➔ [Media Types You Can Use](#)

# Paper Is Smudged/Printed Surface Is Scratched

## Paper Is Smudged

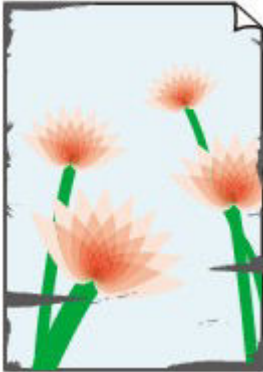

The Edges of Paper Are Smudged Printed Surface Is Smudged



## Printed Surface Is Scratched

**Check1** Did you confirm the paper and print quality settings?

➔ [Print Results Not Satisfactory](#)

**Check2** Is the appropriate type of paper used? Check the followings:

- Check to see if the paper you are printing on is suitable for your printing purpose.
  - ➔ [Media Types You Can Use](#)
- When performing Borderless Printing, make sure that the paper you are using is suitable for Borderless Printing.

If the paper you are using is not suitable for Borderless Printing, the print quality may be reduced at the top and bottom edges of the paper.

➔ [Printing Area](#)

**Check3** Load the paper after correcting its curl.

When using Photo Paper Plus Semi-gloss, even if the sheet is curled, load one sheet at a time as it is. If you roll up this paper to flatten, this may cause cracks on the surface of the paper and reduce the print quality.

We recommend putting unused paper back into the package and keeping it on a level surface.

### • For Plain Paper

Turn the paper over and reload it to print on the other side.

Leaving the paper loaded on the rear tray for a long time may cause the paper to curl. In this case, load the paper with the other side facing up. It may resolve the problem.

### • For Other Paper

If the curl on the four corners of the paper is more than 0.1 inch / 3 mm (A) in height, the paper may be smudged or may not be fed properly. In such cases, follow the procedure described below to correct the paper curl.



1. Roll up the paper in the opposite direction to the paper curl as shown below.



2. Check that the paper is now flat.

We recommend printing curl-corrected paper one sheet at a time.

### ►►► Note

- Depending on the media type, the paper may be smudged or may not be fed properly even if it is not curled inward. In such cases, follow the procedure described below to curl the paper outward within 0.1 inch / 3 mm (B) in height before printing. This may improve the print result.

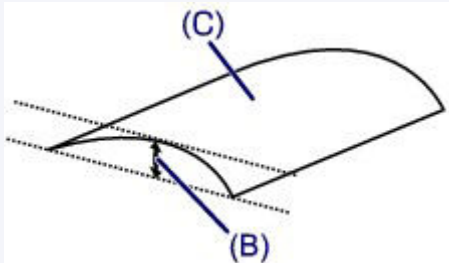

(C) Printing side

We recommend printing paper that has been curled outward one sheet at a time.

### Check4 Adjust the setting to prevent paper abrasion.

Adjusting the setting to prevent paper abrasion will widen the clearance between the print head and the loaded paper. If you notice abrasion even with the media type set correctly to match the loaded paper, set the printer to prevent paper abrasion on the computer.

Print speed may be reduced if you apply the setting to prevent paper abrasion setting.

\* Readjust the setting not to prevent paper abrasion once printing is complete. If not, this setting remains enabled for all subsequent print jobs.

Open the printer driver setup window, and in **Custom Settings** in the **Maintenance** sheet, select the **Prevent paper abrasion** check box, and then click **OK**.

To open the printer driver setup window, see [How to Open the Printer Driver Setup Window](#).

### Check5 If the intensity is set high, reduce the intensity setting and try printing again.

If you are using plain paper to print images with high intensity, the paper may absorb too much ink and become wavy, causing paper abrasion.

Reduce the intensity setting in the printer driver and try printing again.

1. Open the printer driver setup window.

➔ [How to Open the Printer Driver Setup Window](#)

2. On the **Main** sheet, select **Manual** for **Color/Intensity**, and then click **Set...**



3. Drag the **Intensity** slide bar on the **Color Adjustment** sheet to adjust the intensity.

**Check6** Is printing performed beyond the recommended printing area?

If you are printing beyond the recommended printing area of your printing paper, the lower edge of the paper may become stained with ink.

Resize your original document in your application software.

➔ [Printing Area](#)

**Check7** Is the paper feed roller dirty?

Clean the paper feed roller.

➔ [Cleaning the Paper Feed Rollers from Your Computer](#)

**▶▶▶ Note**

- Cleaning the paper feed roller will wear the roller, so perform this procedure only when necessary.

**Check8** Is the inside of the printer dirty?

When performing duplex printing, the inside of the printer may become stained with ink, causing the printout to become smudged.

Perform the Bottom Plate Cleaning to clean the inside of the printer.

➔ [Cleaning Inside the Printer](#)

**▶▶▶ Note**

- To prevent the inside of the printer from stains, set the paper size correctly.

**Check9** Set the time to dry the printed surface longer.

Doing so gives the printed surface enough time to dry so that paper smudged and scratched are prevented.

1. Make sure that the printer is turned on.
2. Open the printer driver setup window.

➔ [How to Open the Printer Driver Setup Window](#)

3. Click the **Maintenance** tab and then **Custom Settings**.
4. Drag the **Ink Drying Wait Time** slide bar to set the wait time, and then click **OK**.
5. Confirm the message and click **OK**.

## Back of the Paper Is Smudged

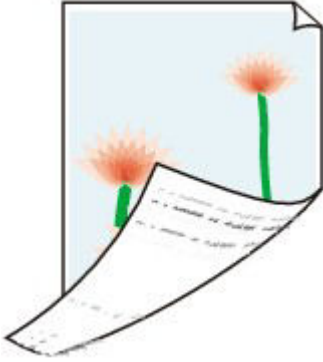

**Check1** Did you confirm the paper and print quality settings?

➔ [Print Results Not Satisfactory](#)

**Check2** Perform the Bottom Plate Cleaning to clean the inside of the printer.

➔ [Cleaning Inside the Printer](#)

### ▶▶▶ Note

- When performing borderless printing, duplex printing, or too much printing, the inside may become stained with ink.

## Vertical Lines Are Printed on the Sides of the Printout

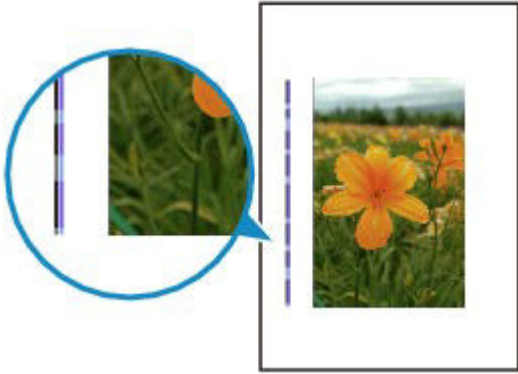

**Check** Is the size of the loaded paper correct?

The vertical lines may be printed in the margin if the size of the loaded paper is larger than that you have specified.

Set the paper size correctly according to the paper you loaded.

➔ [Print Results Not Satisfactory](#)

### ➤➤➤ Note

- The direction of the vertical line pattern may vary depending on the image data or the print setting.
- This printer performs automatic cleaning when necessary to keep printouts clean. A small amount of ink is ejected for cleaning.

Although ink is usually ejected on the ink absorber, it may be ejected on the paper if you load paper larger than that you have specified.

# Colors Are Uneven or Streaked

## Colors Are Uneven



## Colors Are Streaked



**Check1** Did you confirm the paper and print quality settings?

➔ [Print Results Not Satisfactory](#)

**Check2** Print the Nozzle Check Pattern and perform any necessary maintenance operations such as Print Head Cleaning.

Print the Nozzle Check Pattern to determine whether the ink ejects properly from the print head nozzles.

Refer to [When Printing Becomes Faint or Colors Are Incorrect](#) for the Nozzle Check Pattern printing, Print Head Cleaning, and Print Head Deep Cleaning.

- If the Nozzle Check Pattern is not printed correctly:  
Check to see if a particular color's ink tank is not empty.  
If the Nozzle Check Pattern is not printed correctly though ink is sufficient, perform the Print Head Cleaning and try printing the Nozzle Check Pattern again.
- If the problem is not resolved after performing the Print Head Cleaning twice:  
Perform the Print Head Deep Cleaning.  
If the problem is not resolved after performing the Print Head Deep Cleaning, turn off the printer and perform another Print Head Deep Cleaning after 24 hours.
- If the problem is not resolved after performing the Print Head Deep Cleaning twice:

If Print Head Deep Cleaning does not resolve the problem, the print head may be damaged. Contact the service center.

**Check3** Perform Print Head Alignment.

➔ [Aligning the Print Head](#)

**▶▶▶ Note**

- If the problem is not resolved after performing the Print Head Alignment, perform Print Head Alignment manually referring to [Aligning the Print Head Position Manually from Your Computer](#).

## Ink Is Not Ejected

### Check1 Has the ink run out?

Open the top cover, then check the status of ink lamp.

➔ [Checking the Ink Status](#)

### Check2 Is the orange tape or protective film remaining?

Make sure that all of the protective film is peeled off and the Y-shape air hole is exposed, as illustrated in (A).

If the orange tape is left as in (B), pull the orange tape and remove it.

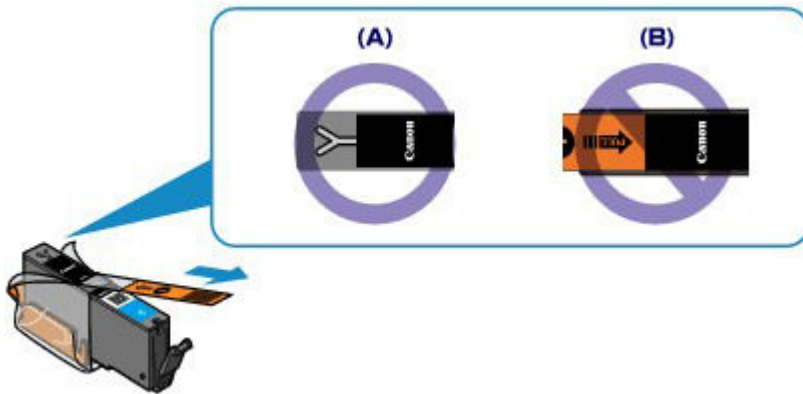

### Check3 Are the print head nozzles clogged?

Print the Nozzle Check Pattern to determine whether the ink ejects properly from the print head nozzles.

Refer to [When Printing Becomes Faint or Colors Are Incorrect](#) for the Nozzle Check Pattern printing, Print Head Cleaning, and Print Head Deep Cleaning.

- If the Nozzle Check Pattern is not printed correctly:  
Check to see if a particular color's ink tank is not empty.  
If the Nozzle Check Pattern is not printed correctly though ink is sufficient, perform the Print Head Cleaning and try printing the Nozzle Check Pattern again.
- If the problem is not resolved after performing the Print Head Cleaning twice:  
Perform the Print Head Deep Cleaning.  
If the problem is not resolved after performing the Print Head Deep Cleaning, turn off the printer and perform another Print Head Deep Cleaning after 24 hours.
- If the problem is not resolved after performing the Print Head Deep Cleaning twice:  
If Print Head Deep Cleaning does not resolve the problem, the print head may be damaged. Contact the service center.

## **Problems with the Printer**

- ▶ **The Printer Cannot Be Powered On**
- ▶ **The Printer Turns Off Unintentionally**
- ▶ **Cannot Connect to Computer with a USB Cable Properly**
- ▶ **Cannot Communicate with the Printer with USB Connection**
- ▶ **Print Head Holder Does Not Move to the Position for Replacing**
- ▶ **Printer Status Monitor Is Not Displayed**

## The Printer Cannot Be Powered On

**Check1** Press the **ON** button.

**Check2** Make sure that the power plug is securely plugged into the power cord connector of the printer, then turn it back on.

**Check3** Unplug the printer from the power supply, then plug the printer back in and turn the printer back on after leaving it for at least 3 minutes.

If the problem is not resolved, contact the service center.



## The Printer Turns Off Unintentionally

**Check** Deactivate the setting to turn the unit off automatically.

The printer turns off automatically according to the elapsed time you specified if you activate the setting to turn the unit off automatically.

If you do not want the printer to turn off automatically, open the printer driver setup window and in **Auto Power** under the **Maintenance** sheet, select **Disable** for **Auto Power Off**.

## Cannot Connect to Computer with a USB Cable Properly

### Printing Speed Is Slow/Hi-Speed USB Connection Does Not Work/"This device can perform faster" Message Is Displayed

If your system environment is not fully compatible with Hi-Speed USB, the printer will operate at a lower speed provided under USB 1.1. In this case, the printer operates properly but printing speed may slow down due to communication speed.

**Check** Check the following to make sure that your system environment supports Hi-Speed USB connection.

- Does the USB port on your computer support Hi-Speed USB connection?
- Does the USB cable or the USB hub support Hi-Speed USB connection?

Be sure to use a certified Hi-Speed USB cable. We recommend that the cable is no longer than around 10 feet / 3 meters.

- Does the operating system of your computer support Hi-Speed USB connection?

Obtain and install the latest update for your computer.

- Does the Hi-Speed USB driver operate properly?

Obtain the latest version of the Hi-Speed USB driver compatible with your hardware and reinstall it on your computer.

#### **»» Important**

- For details on Hi-Speed USB of your system environment, contact the manufacturer of your computer, USB cable, or USB hub.

## Cannot Communicate with the Printer with USB Connection

**Check1** Make sure that the printer is turned on.

**Check2** Make sure that the USB cable is connected properly.

See [Connecting the Printer to the Computer Using a USB Cable](#) to connect the USB cable properly.

**Check3** Do not start up IJ Network Tool while printing.

**Check4** Do not print while IJ Network Tool is running.

**Check5** Make sure that **Enable bidirectional support** is selected in the **Ports** sheet of the properties dialog box of the printer driver.

➔ [How to Open the Printer Driver Setup Window](#)

# Print Head Holder Does Not Move to the Position for Replacing

## Check1 Is the **POWER** lamp off?

Check if the **POWER** lamp is lit.

The print head holder will not move unless the power is on. If the **POWER** lamp is off, close the top cover and turn the printer on.

While the **POWER** lamp is flashing, the printer is initializing. Wait until the **POWER** lamp stops flashing and remains lit, and then open the top cover again.

## Check2 Is the **Alarm** lamp flashing?

Close the top cover, confirm the number of times the **Alarm** lamp is flashing, take the appropriate action to resolve the error, and then reopen it. For details on how to resolve the error, see [If an Error Occurs](#).

## Check3 Has the top cover been left open for 10 minutes or longer?

If the top cover is left open for more than 10 minutes, the print head holder moves to the position to protect it to prevent the print head from drying out. Close and reopen the top cover to return the print head holder to the position for replacing.

## Check4 Has the printer been printing continuously for a long period?

Close the top cover, wait a while, then reopen it.

If the printer has been printing continuously for a long time, the print head holder may not move to the position for replacing since the print head may overheat.

### »» Note

- Opening the top cover while printing moves the print head holder to the position to protect it. Close the top cover, and reopen it after printing finishes.

# Printer Status Monitor Is Not Displayed

**Check** Is the printer status monitor enabled?

Make sure that **Enable Status Monitor** is selected on the **Option** menu of the printer status monitor.

1. Open the printer driver setup window.  
    ➔ [How to Open the Printer Driver Setup Window](#)
2. On the **Maintenance** sheet, click **View Printer Status**.
3. Select **Enable Status Monitor** on the **Option** menu if it is not selected.

## **Problems with Installation/Downloading**

- ▶ **Cannot Install the Printer Driver**
- ▶ **Easy-WebPrint EX Does Not Start Up or Easy-WebPrint EX Menu Does Not Appear**
- ▶ **How to Update Printer Driver in Network Environment**
- ▶ **Uninstalling IJ Network Tool**

## Cannot Install the Printer Driver

- If the installation does not start even after the Setup CD-ROM is inserted into your computer's disc drive:

Start the installation following the procedure below.

1. Select items as shown below.

- In Windows 8, select the **Explorer** icon in **Taskbar on Desktop**, then select **Computer** from the list on the left.
- In Windows 7 or Windows Vista, click **Start** then **Computer**.
- In Windows XP, click **Start** then **My Computer**.

2. Double-click the  **CD-ROM** icon on the displayed window.

If the contents of the CD-ROM are displayed, double-click **MSETUP4.EXE**.

If you cannot install the printer driver with the Setup CD-ROM, install it from our website.

### »» Note

- If the CD-ROM icon is not displayed, try the following:
  - Remove the CD-ROM from your computer, then insert it again.
  - Restart your computer.

If the icon is not yet displayed, try different discs and see if they are displayed. If other discs are displayed, there is a problem with the Setup CD-ROM. In this case, contact the service center.

- If you are unable to proceed beyond the Printer Connection screen:

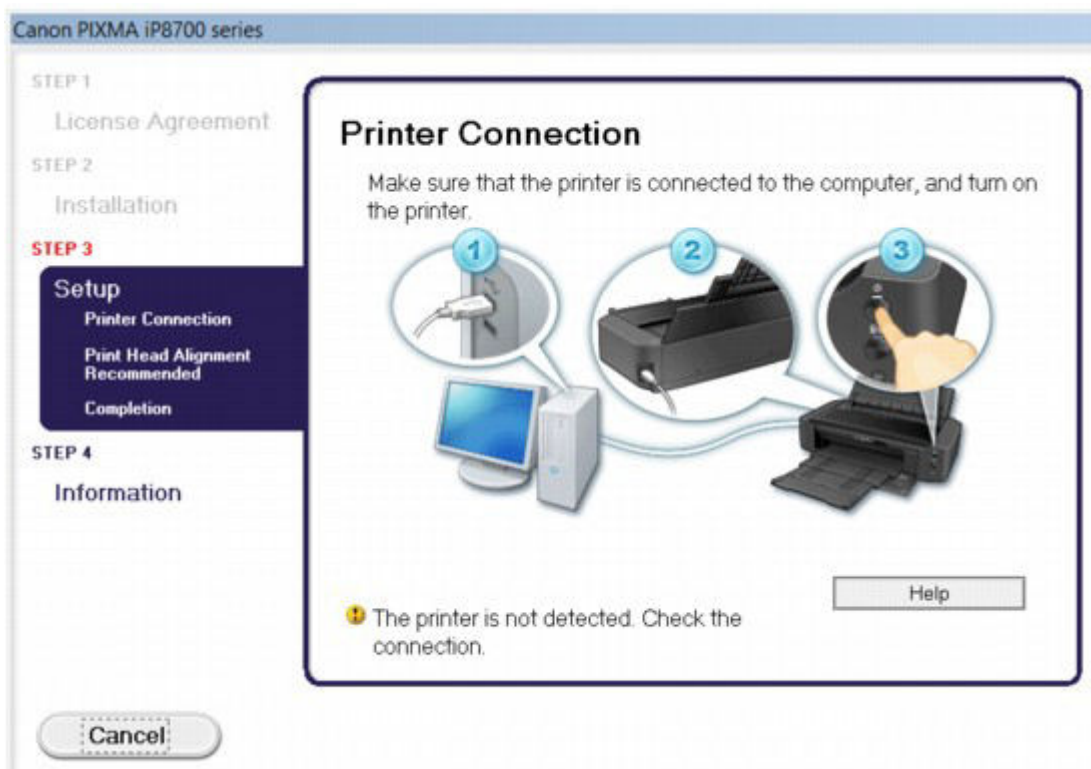

## »» Note

- **The printer is not detected. Check the connection.** may be displayed depending on the computer you use.

**Check1** Make sure that the USB cable is securely plugged in to the printer and the computer.

**Check2** Follow the procedure below to connect the printer and the computer again.

1. Turn the printer off.
2. Unplug the USB cable from the printer and the computer, then connect it again.
3. Turn the printer on.

**Check3** If you cannot resolve the problem, follow the procedure below to reinstall the printer driver.

1. Click **Cancel**.
2. Click **Start Over** on the **Installation Failure** screen.
3. Click **Exit** on the "PIXMA XXX" screen (where "XXX" is your printer's name), then remove the CD-ROM.
4. Turn the printer off.
5. Restart the computer.
6. Make sure that you have no application software running.
7. Insert the CD-ROM again, then install the printer driver.

• **In other cases:**

Reinstall the printer driver.

If the driver was not installed correctly, uninstall the printer driver, restart your computer, then reinstall the driver.

➔ [Deleting the Unnecessary Printer Driver](#)

If you reinstall the printer driver, install the printer driver with the Setup CD-ROM or install it from our website.

## »» Note

- If the installer was forced to be terminated due to a Windows error, the system may be in an unstable condition and you may not be able to install the driver. Restart your computer before reinstalling.



## Easy-WebPrint EX Does Not Start Up or Easy-WebPrint EX Menu Does Not Appear

If Easy-WebPrint EX does not start up or its menu does not appear on Internet Explorer, confirm the following.

**Check1** Is **Canon Easy-WebPrint EX** displayed on the **Toolbars** menu in the Internet Explorer's **View** menu?

If **Canon Easy-WebPrint EX** is not displayed, Easy-WebPrint EX is not installed on your computer. Install the latest Easy-WebPrint EX onto your computer from our website.

### »» Note

- If Easy-WebPrint EX is not installed on your computer, a message asking you to install it may be displayed on the notification area on the desktop. Click the message, then follow the instructions on the computer screen to install Easy-WebPrint EX.
- While the installation or download Easy-WebPrint EX is in progress, it is necessary to access the Internet.

**Check2** Is **Canon Easy-WebPrint EX** selected on the **Toolbars** menu in the Internet Explorer's **View** menu?

If **Canon Easy-WebPrint EX** is not selected, Easy-WebPrint EX is disabled. Select **Canon Easy-WebPrint EX** to enable it.

## How to Update Printer Driver in Network Environment

Download the latest printer driver in advance.

To obtain the latest printer driver, access our web site through the Internet and download the latest printer driver for your model.

After uninstalling the printer driver, install the latest printer driver according to the regular procedure. When the connection method selection screen is displayed, select **Use the printer with wireless LAN connection**. The printer will be detected automatically in the network.

After making sure that the printer is detected, install the printer driver following the on-screen instructions.

### **Note**

- You can use the printer over a LAN without performing setup again.

# Uninstalling IJ Network Tool

Follow the procedure below to uninstall IJ Network Tool from your computer.

## »» Important

- Even if IJ Network Tool is uninstalled, you can print from the computer over network. However, you cannot change the network settings over network.
- Log into a user account with administrator privilege.

### 1. Perform the procedure to uninstall IJ Network Tool.

- In Windows 8:
  1. Select **Control Panel** from the **Settings** charm on **Desktop > Programs > Programs and Features**.
  2. Select **Canon IJ Network Tool** from the program list, then click **Uninstall**.  
If the **User Account Control** screen appears, click **Continue**.
- In Windows 7 or Windows Vista:
  1. Click **Start > Control Panel > Programs > Programs and Features**.
  2. Select **Canon IJ Network Tool** from the program list, then click **Uninstall**.  
If the **User Account Control** screen appears, click **Continue**.
- In Windows XP:
  1. Click **Start > Control Panel > Add or Remove Programs**.
  2. Select **Canon IJ Network Tool** from the program list, then click **Remove**.

### 2. Click **Yes** when the confirmation message appears.

When the message prompting you to restart your computer is displayed, click **OK** to restart your computer.

## **About Errors/Messages Displayed**

- ▶ **If an Error Occurs**
- ▶ **A Message Is Displayed**
- ▶ **Error Message Appears on a PictBridge (Wireless LAN) Compliant Device**

## If an Error Occurs

When an error occurs in printing such as the printer is out of paper or paper is jammed, a troubleshooting message is displayed automatically. Take the appropriate action described in the message.

When an error occurs, the **Alarm** lamp flashes orange and a Support Code (error number) is displayed on the computer screen. For some errors, the **POWER** lamp and the **Alarm** lamp flashes alternately. Check the status of the lamps and the message, then take the appropriate action to resolve the error.

### Support Code Corresponding to the Number of Flashes of the Alarm Lamp

Example of 2 times flashing:



(A) Flashes

(B) Goes off

Number of flashes	Cause	Support Code
2 flashes	There is no paper in the rear tray.	<a href="#">1000</a>
	There is no disc tray.	<a href="#">1001</a>
	Printable disc (BD/DVD/CD, etc.) is not set.	<a href="#">1002</a>
	The paper size in the print settings and the size of the loaded paper do not match.	<a href="#">2100</a> , <a href="#">2101</a>
3 flashes	The front cover is closed.	<a href="#">1250</a>
	Paper is jammed in the paper output slot or in the rear tray.	<a href="#">1300</a>
4 flashes	If the lamp on the ink tank is flashing, ink may have run out.	<a href="#">1600</a>
	The ink tank is not installed.	<a href="#">1660</a>
5 flashes	The print head may be damaged.	<a href="#">1401</a> , <a href="#">1403</a> , <a href="#">1405</a>
6 flashes	A certain period of time has elapsed while disc label printing is in progress.	<a href="#">1830</a>
	The disc tray guide is closed.	<a href="#">1850</a>
	The disc tray guide is open.	<a href="#">1851</a>
	The disc tray guide has been closed.	<a href="#">1855</a>

	The disc tray guide has been opened.	<a href="#">1856</a>
	The disc tray guide is open when starting disc label printing.	<a href="#">1857</a>
	The disc tray guide is open after replacing the ink tank.	<a href="#">1858</a>
7 flashes	Some ink tanks are not installed in the correct position. (The lamp on the ink tank flashes.)	<a href="#">1680</a>
	More than one ink tanks of the same color are installed. (The lamp on the ink tank flashes.)	<a href="#">1681</a>
8 flashes	The ink absorber is almost full.	<a href="#">1700</a> , <a href="#">1701</a>
11 flashes	Automatic Print Head Alignment failed.	<a href="#">2500</a>
	Cannot perform printing with the current print setting.	<a href="#">4103</a>
12 flashes	You cannot print the contents on CREATIVE PARK PREMIUM.	<a href="#">4100</a>
13 flashes	The remaining ink level cannot be correctly detected. (The lamp on the ink tank flashes.)	<a href="#">1683</a>
14 flashes	The ink tank cannot be recognized.	<a href="#">1684</a>
15 flashes	The ink tank cannot be recognized.	<a href="#">1410</a> , <a href="#">1411</a> , <a href="#">1412</a> , <a href="#">1413</a> , <a href="#">1414</a> , <a href="#">1415</a>
16 flashes	The ink has run out. (The lamp on the ink tank flashes.)	<a href="#">1688</a>
21 flashes	The printer cannot detect the paper size.	<a href="#">2103</a>
22 flashes	The printer has detected that the paper has been fed aligned to one side.	<a href="#">2102</a>

## Support Code Corresponding to the Number of Alternate Flashes of the POWER Lamp and the Alarm Lamp

Example of 2 times flashing:

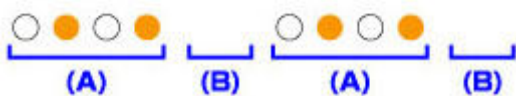
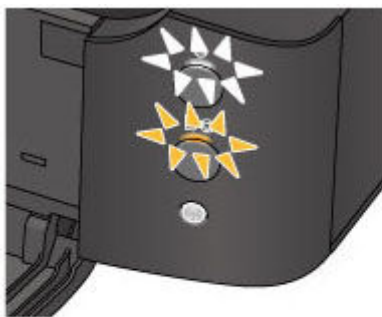

(A) Flashes

(B) Goes off

Number of flashes	Cause	Support Code
-------------------	-------	--------------

2 flashes	Printer error has occurred.	<a href="#">5100</a>
7 flashes	Printer error has occurred.	<a href="#">5B00</a> , <a href="#">5B01</a>
10 flashes	An error requiring you to contact the service center has occurred.	<a href="#">B200</a>
Other cases than above	Printer error has occurred.	<a href="#">5101</a> , <a href="#">5200</a> , <a href="#">5400</a> , <a href="#">5700</a> , <a href="#">5C00</a> , <a href="#">5C20</a> , <a href="#">6000</a> , <a href="#">6001</a> , <a href="#">6500</a> , <a href="#">6502</a> , <a href="#">6800</a> , <a href="#">6801</a> , <a href="#">6900</a> , <a href="#">6901</a> , <a href="#">6902</a> , <a href="#">6910</a> , <a href="#">6911</a> , <a href="#">6930</a> , <a href="#">6931</a> , <a href="#">6932</a> , <a href="#">6933</a> , <a href="#">6940</a> , <a href="#">6941</a> , <a href="#">6942</a> , <a href="#">6943</a> , <a href="#">6944</a> , <a href="#">6945</a> , <a href="#">6946</a> , <a href="#">6A80</a> , <a href="#">6A81</a> , <a href="#">6A90</a> , <a href="#">C000</a>

- **When a Support Code and a message are displayed on the computer screen:**

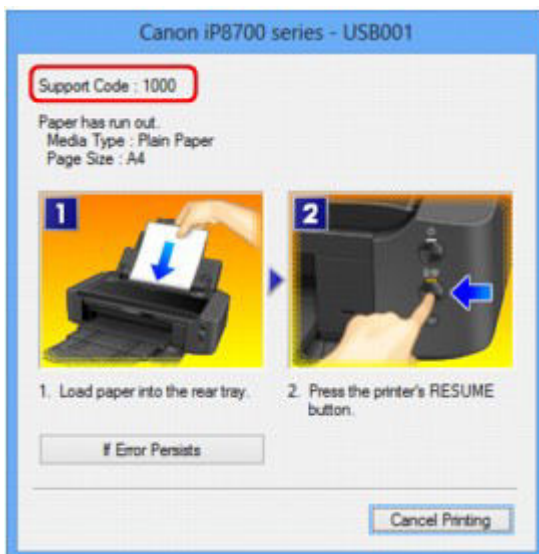

\* The screen differs depending on the OS you are using.

### ▶▶▶ Note

- You can confirm the actions against errors with Support Codes on your computer by searching a Support Code.

➡ [Click Here to Search](#)

For details on how to resolve errors without Support Codes, see [A Message Is Displayed](#).

# A Message Is Displayed

This section describes some of the errors or messages.

## ►► Note

- A Support Code (error number) is displayed on the computer for some error or message. For details on errors with Support Codes, refer to [Support Code List](#).

- ➔ [Error Regarding the Power Cord Being Unplugged Is Displayed](#)
- ➔ [Writing Error/Output Error/Communication Error](#)
- ➔ [Other Error Messages](#)
- ➔ [The Inkjet Printer/Scanner/Fax Extended Survey Program Screen Is Displayed](#)

## Error Regarding the Power Cord Being Unplugged Is Displayed

The power cord may have been unplugged while the printer was still on.

Check the error message that appears on the computer, then click **OK**.

The printer starts printing.

See [Notice for Unplugging the Power Cord](#) for unplugging the power cord.

## Writing Error/Output Error/Communication Error

**Check1** If the **POWER** lamp is off, make sure that the power plug is plugged in, then turn the printer on.

While the **POWER** lamp is flashing, the printer is initializing. Wait until the **POWER** lamp stops flashing and remains lit.

**Check2** Make sure that the printer port is configured appropriately in the printer driver.

\* In the following instructions, "XXX" signifies your printer's name.

1. Log on as a user account with administrator privilege.
2. Select items as shown below.
  - In Windows 8, select **Control Panel** from the **Settings** charm on **Desktop > Hardware and Sound > Devices and Printers**.
  - In Windows 7, select **Devices and Printers** from the **Start** menu.
  - In Windows Vista, select the **Start** menu > **Control Panel > Hardware and Sound > Printers**.
  - In Windows XP, select the **Start** menu > **Control Panel > Printers and Other Hardware > Printers and Faxes**.
3. Open the properties of printer driver for the printer.
  - In Windows 8 or Windows 7, right-click the "Canon XXX" icon (where "XXX" is your printer's name), then select **Printer properties**.
  - In Windows Vista or Windows XP, right-click the "Canon XXX" icon (where "XXX" is your printer's name), then select **Properties**.
4. Click the **Ports** tab to confirm the port settings.



Make sure that a port named "USBnnn" (where "n" is a number) with "Canon XXX" appearing in the **Printer** column is selected for **Print to the following port(s)**.

### ▶▶▶ Note

- When the printer is used over LAN, the port name of the printer is displayed as "CNBJNP\_XXXXXXXXXX". "XXXXXXXXXX" is the character string generated from the MAC address or a character string specified by the user when setting up the printer.

- If the setting is incorrect:

Reinstall the printer driver with the Setup CD-ROM or install it from our website.

- Printing does not start even though the printer is connected to the computer using a USB cable and the port named "USBnnn" is selected:

In Windows 8, select **My Printer** on the **Start** screen to start **My Printer**. If **My Printer** is not displayed on the **Start** screen, select the **Search** charm, then search for "**My Printer**".

Set the correct printer port on **Diagnose and Repair Printer**. Follow the on-screen instructions to set the correct printer port, then select your printer's name.

In Windows 7, Windows Vista, or Windows XP, click **Start** and select **All programs, Canon Utilities, Canon My Printer, Canon My Printer**, then select **Diagnose and Repair Printer**. Follow the on-screen instructions to set the correct printer port, then select your printer's name.

If the problem is not resolved, reinstall the printer driver with the Setup CD-ROM or install it from our website.

- Printing does not start even though the port named "CNBJNP\_XXXXXXXXXX" is selected when the printer is used over LAN:

Launch IJ Network Tool, and select "CNBJNP\_XXXXXXXXXX" as you confirmed in step 4, then associate the port with the printer using **Associate Port** in the **Settings** menu.

If the problem is not resolved, reinstall the printer driver with the Setup CD-ROM or install it from our website.

### Check3 Make sure that the printer is connected to your computer properly.

When the printer is connected to your computer with a USB cable, make sure that the USB cable is securely plugged in to the printer and the computer, then check the followings:

- If you are using a relay device such as a USB hub, disconnect it, connect the printer directly to the computer, and try printing again. If printing starts normally, there is a problem with the relay device. Consult the reseller of the relay device for details.
- There could also be a problem with the USB cable. Replace the USB cable and try printing again.

When you use the printer over LAN, make sure that the printer is set up to be used over network correctly.

### Check4 Make sure that the printer driver is installed correctly.

Uninstall the printer driver following the procedure described in [Deleting the Unnecessary Printer Driver](#), then reinstall the printer driver with the Setup CD-ROM or reinstall it from our website.

### Check5 When the printer is connected to your computer with a USB cable, check the status of the device on your computer.

Follow the procedure below to check the status of the device.

1. Open the Device Manager on your computer as shown below.

If the **User Account Control** screen is displayed, follow the on-screen instructions.

- In Windows 8, select **Control Panel** from the **Settings** charm on **Desktop > Hardware and Sound > Device Manager**.
  - In Windows 7 or Windows Vista, click **Control Panel, Hardware and Sound**, then **Device Manager**.
  - In Windows XP, click **Control Panel, Performance and Maintenance, System**, then click **Device Manager** on the **Hardware** sheet.
2. Double-click **Universal Serial Bus controllers** then **USB Printing Support**.
- If the **USB Printing Support Properties** screen is not displayed, make sure that the printer is correctly connected to the computer.
- ➔ **Check3** [Make sure that the printer is connected to your computer properly.](#)
3. Click the **General** tab and make sure that there is no indication of a problem with the device.
- If a device error is displayed, refer to Windows help to resolve the error.

## Other Error Messages

**Check** If an error message is displayed outside the printer status monitor, check the following:

- **"Could not spool successfully due to insufficient disk space"**  
Delete any unnecessary files to increase the amount of free space on the disk.
- **"Could not spool successfully due to insufficient memory"**  
Quit other running application softwares to increase available memory.  
If you cannot print yet, restart your computer and retry printing.
- **"Printer driver could not be found"**  
Uninstall the printer driver following the procedure described in [Deleting the Unnecessary Printer Driver](#), then reinstall the printer driver with the Setup CD-ROM or reinstall it from our website.
- **"Could not print Application name - File name"**  
Try printing again once the current job is complete.

## The Inkjet Printer/Scanner/Fax Extended Survey Program Screen Is Displayed

If the Inkjet Printer/Scanner/Fax Extended Survey Program is installed, a confirmation screen asking for permission to send the printer and application software usage information will be displayed every month for about ten years.

Read the instructions on the screen and follow the procedure below.

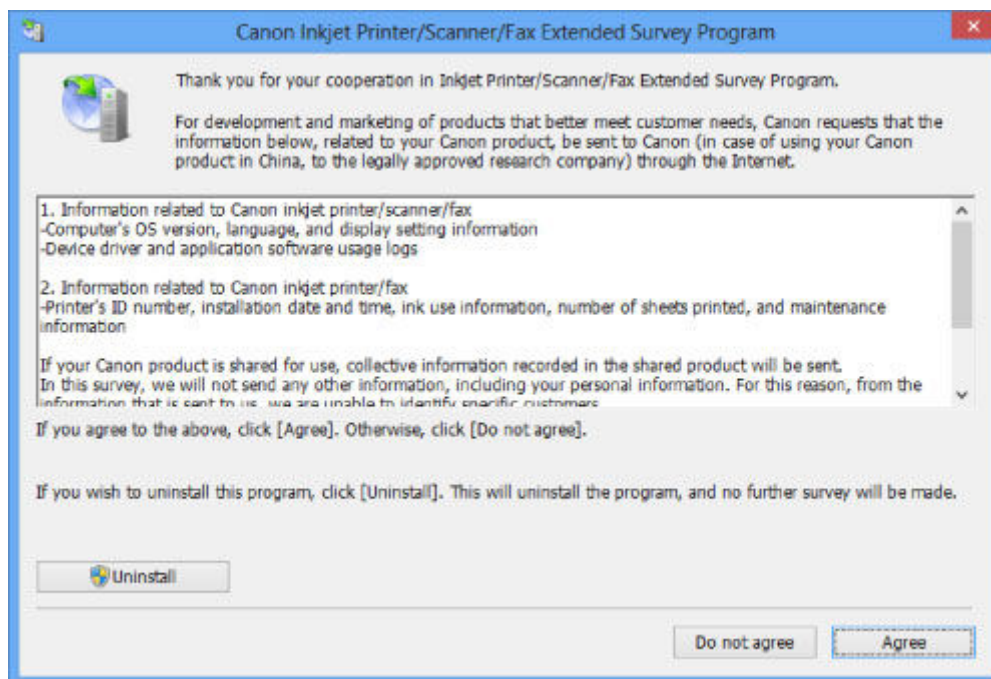

- **If you agree to participate in the survey program:**

Click **Agree**, then follow the on-screen instructions. The printer usage information will be sent via the Internet. If you have followed the on-screen instructions, the information will be sent automatically from the second time onward and the confirmation screen will not be displayed again.

➤➤➤ **Note**

- When the information is being sent, a caution screen such as an Internet security screen may be displayed. In this case, confirm that the program name is "IJPLMUI.exe", then allow it.
- If you deselect the **Send automatically from the next time** check box, the information will not be sent automatically from the second time onward and a confirmation screen will be displayed at the time of the next survey. To send the information automatically, see [Changing the confirmation screen setting](#).

- **If you do not agree to participate in the survey program:**

Click **Do not agree**. The confirmation screen will be closed, and the survey at that time is skipped. The confirmation screen will be displayed again one month later.

- **To uninstall the Inkjet Printer/Scanner/Fax Extended Survey Program:**

To uninstall the Inkjet Printer/Scanner/Fax Extended Survey Program, click **Uninstall**, then follow the on-screen instructions.

- **Changing the confirmation screen setting:**

1. Select items as shown below.
  - In Windows 8, select **Control Panel** from the **Settings** charm on **Desktop** > **Programs** > **Programs and Features**.
  - In Windows 7, or Windows Vista, select the **Start** menu > **Control Panel** > **Programs** > **Programs and Features**.
  - In Windows XP, select the **Start** menu > **Control Panel** > **Add or Remove Programs**.

»»» **Note**

- In Windows 8, Windows 7 or Windows Vista, a confirmation/warning dialog box may appear when installing, uninstalling or starting up software.

This dialog box appears when administrative rights are required to perform a task.

If you are logged on to an administrator account, follow the on-screen instructions.

2. Select **Canon Inkjet Printer/Scanner/Fax Extended Survey Program**.

3. Select **Change**.

If you select **Yes** after you have followed the on-screen instructions, the confirmation screen will be displayed at the time of the next survey.

If you select **No**, the information will be sent automatically.

»»» **Note**

- If you select **Uninstall** (or **Remove** in Windows XP), the Inkjet Printer/Scanner/Fax Extended Survey Program is uninstalled. Follow the on-screen instructions.

# Error Message Appears on a PictBridge (Wireless LAN) Compliant Device

The following are the possible errors that may occur when printing directly from a PictBridge (Wireless LAN) compliant device and the countermeasures to clear them.

## ▶▶▶ Note

- This section describes errors that are indicated on Canon-brand PictBridge (Wireless LAN) compliant devices. The error messages and operations may vary depending on the device you are using. For errors on non-Canon PictBridge (Wireless LAN) compliant devices, check the status of the **Alarm** lamp and take the appropriate action to clear the error. For details, see [If an Error Occurs](#).
- For the errors indicated on the PictBridge (Wireless LAN) compliant device and their solution, also refer to the instruction manual of the device. For other troubles on the device, contact the manufacturer.

Error Message on the PictBridge (Wireless LAN) Compliant Device	Action
"Printer in use"	<p>If the printer is printing from the computer or warming up, wait until the job ends.</p> <p>When it is ready, the printer starts printing automatically.</p> <p>If the printer is not printing from the computer or warming up, check the number of how many the <b>Alarm</b> lamp flashes and take the appropriate action to resolve the error.</p> <p>➡ <a href="#">If an Error Occurs</a></p>
"No paper"	<p>Load paper, and select <b>Continue</b>* in the display on your PictBridge (Wireless LAN) compliant device.</p> <p>* To resume printing, you can also press the <b>RESUME/CANCEL</b> button on the printer instead of selecting <b>Continue</b> on the device.</p>
"Paper Error"	<ul style="list-style-type: none"> <li>• If the front cover is closed, open it and select <b>Continue</b>* in the display on your PictBridge (Wireless LAN) compliant device.</li> <li>* To resume printing, you can also press the <b>RESUME/CANCEL</b> button on the printer instead of selecting <b>Continue</b> on the device.</li> <li>• If the disc tray guide is opened, close it and select <b>Stop</b> in the display on your PictBridge (Wireless LAN) compliant device to stop printing.</li> </ul> <p>If neither of the above is applied, check the number of how many the <b>Alarm</b> lamp flashes and take the appropriate action to resolve the error.</p> <p>➡ <a href="#">If an Error Occurs</a></p>
"Paper jam"	<p>Select <b>Stop</b> in the display on your PictBridge (Wireless LAN) compliant device to stop printing.</p> <p>Remove the jammed paper, load new paper, press the <b>RESUME/CANCEL</b> button on the printer, then try printing again.</p>
"Printer cover open"	<p>Close the top cover on the printer.</p>
"Waste tank full"/"Ink absorber full"	<p>The ink absorber is nearly full.</p> <p>Check the number of how many the <b>Alarm</b> lamp flashes and take the appropriate action to resolve the error.</p>

	<p>➡ <a href="#">If an Error Occurs</a></p>
"No ink"/"Ink cassette error"	<p>Check the number of how many the <b>Alarm</b> lamp flashes and take the appropriate action to resolve the error.</p> <p>➡ <a href="#">If an Error Occurs</a></p>
"Ink Error"	<p>An ink tank that was once empty is installed.</p> <p>When the <b>Alarm</b> lamp flashes 13 times, refer to <a href="#">1683</a> to resolve the error.</p>
"Hardware Error"	<p>The ink tank cannot be recognized. (The lamp on the ink tank is off.)</p> <p>Replace the ink tank.</p> <p>➡ <a href="#">Replacing an Ink Tank</a></p>
"Printer error"	<p>An error requiring servicing may have occurred.</p> <p>Turn off the printer, and unplug the power cord of the printer from the power supply.</p> <p>Plug the printer back in and turn the printer back on.</p> <p>If the problem is not resolved, contact the service center.</p>

## If You Cannot Resolve the Problem

If you cannot resolve the problem with any of the workarounds in this chapter, please contact the seller of the printer or the service center.

Canon support staff are trained to be able to provide technical support to satisfy customers.

### **Caution**

- If the printer emits any unusual sound, smoke, or odor, turn it off immediately. Unplug the power cord from the outlet and contact the seller or the service center. Never attempt to repair or disassemble the printer yourself.
- Attempts by customers to repair or take apart the printer will invalidate any warranty regardless of whether the warranty has expired.

Before contacting the service center, confirm the following:

- Product name:
  - \* Your printer's name is located on the front cover of the setup manual.
- Serial number: please refer to the setup manual
- Details of the problem
- What you tried to solve the problem, and what happened

# Support Code List

The support code appears on the computer screen when an error occurs.

"Support Code" means the error number and appears with an error message.

When an error occurs, check the support code displayed on the computer screen and take the appropriate action.

## Support Code Appears on the Computer Screen

- **1000 to 1ZZZ**

[1000](#) [1001](#) [1002](#) [1200](#) [1250](#) [1300](#)

[1401](#) [1403](#) [1405](#) [1410](#) [1411](#) [1412](#)

[1413](#) [1414](#) [1415](#) [1600](#) [1660](#) [1680](#)

[1681](#) [1683](#) [1684](#) [1688](#) [1700](#) [1701](#)

[1830](#) [1850](#) [1851](#) [1855](#) [1856](#) [1857](#)

[1858](#)

- **2000 to 2ZZZ**

[2100](#) [2101](#) [2102](#) [2103](#) [2500](#)

- **4000 to 4ZZZ**

[4100](#) [4103](#)

- **5000 to 5ZZZ**

[5100](#) [5101](#) [5200](#) [5400](#) [5700](#) [5B00](#)

[5B01](#) [5C00](#) [5C20](#)

- **6000 to 6ZZZ**

[6000](#) [6001](#) [6500](#) [6502](#) [6800](#) [6801](#)

[6900](#) [6901](#) [6902](#) [6910](#) [6911](#) [6930](#)

[6931](#) [6932](#) [6933](#) [6940](#) [6941](#) [6942](#)

[6943](#) [6944](#) [6945](#) [6946](#) [6A80](#) [6A81](#)

[6A90](#)



- **A000 to ZZZZ**

[B200](#) [C000](#)

About the support code for paper jam, you can also refer to [Support Code List \(When Paper Is Jammed\)](#).

## Support Code List (When Paper Is Jammed)

If the paper is jammed, remove it following the procedure appropriate for each case.

- If you can see the jammed paper at the paper output slot or the rear tray:
  - ➡ [1300](#)
- If the paper tears and you cannot remove it from the paper output slot or from the rear tray:
  - ➡ [Paper Is Jammed inside the Printer](#)
- Cases other than above:
  - ➡ [In Other Cases](#)

## 1300

### Cause

Paper is jammed in the paper output slot or in the rear tray.

### Action

Remove the jammed paper following the procedure below.

#### ►► Note

- If you need to turn off the printer to remove jammed paper during printing, press the **RESUME/CANCEL** button to cancel print jobs before turning off the printer.

1. Pull the paper out slowly, either from the rear tray or from the paper output slot, whichever is easier.

Hold the paper with your hands, then pull the paper out slowly not to tear it.



#### ►► Note

- If you cannot pull the paper out, turn the printer off and turn it back on. The paper may be ejected automatically.
- If the paper tears and you cannot remove the jammed paper from the paper output slot or the rear tray, remove the paper from inside the printer.

➔ [Paper Is Jammed inside the Printer](#)

2. Reload the paper, and press the **RESUME/CANCEL** button on the printer.

If you turned off the printer in step 1, all print jobs in the queue are canceled. Reprint if necessary.

#### ►► Note

- When reloading the paper, confirm that you are using the paper suited for printing and are loading it correctly.
- We recommend you use paper other than A5 sized one to print documents with photos or graphics; otherwise, the printout may curl and cause paper exit jams.

If you cannot remove the paper or the paper tears inside the printer, or if the paper jam error continues after removing the paper, contact the service center.

## Paper Is Jammed inside the Printer

If the jammed paper tears and you cannot remove the paper either from the paper output slot or from the rear tray, or if the jammed paper remains inside the printer, remove the paper following the procedure below.

### ▶▶ Note

- If you need to turn off the printer to remove jammed paper during printing, press the **RESUME/CANCEL** button to cancel print jobs before turning off the printer.

1. Turn off the printer, and unplug the power cord of the printer from the power supply.
2. Open the top cover.



### ▶▶ Important

- Do not touch the clear film (A) or the white belt (B).

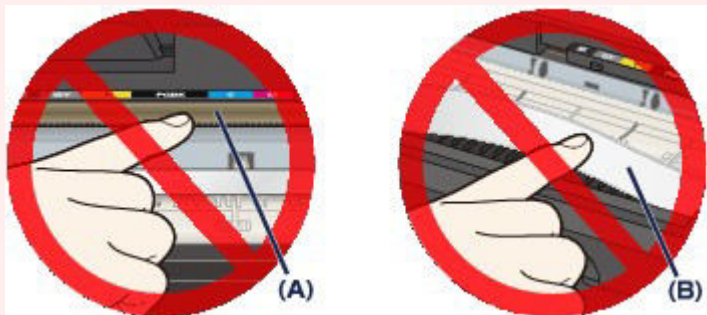

If the paper or your hands touch these parts and blot or scratch them, the printer can be damaged.

3. Make sure that the jammed paper is not under the print head holder.

If the jammed paper is under the print head holder, move the print head holder to the right edge or the left edge whichever is easier to remove the paper.

When you move the print head holder, hold the top of the print head holder and slide it slowly to the right edge or the left edge.

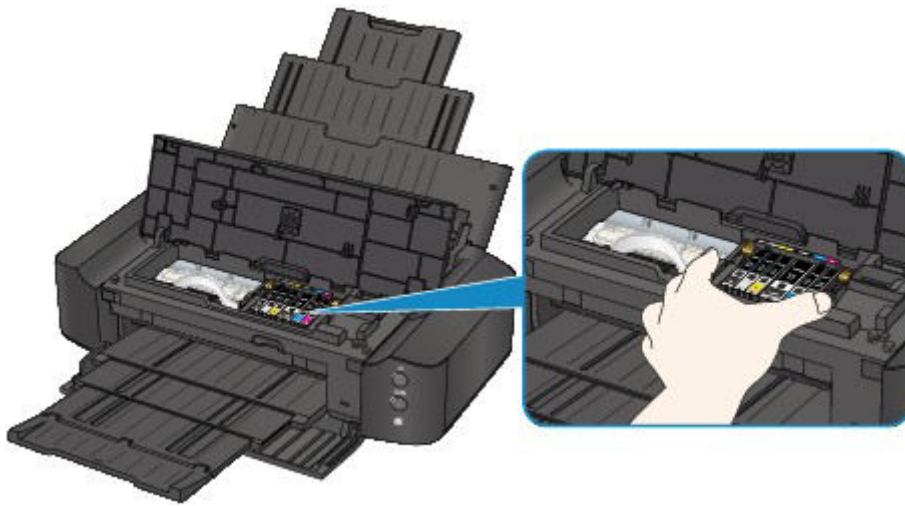

4. Hold the jammed paper with your hands.

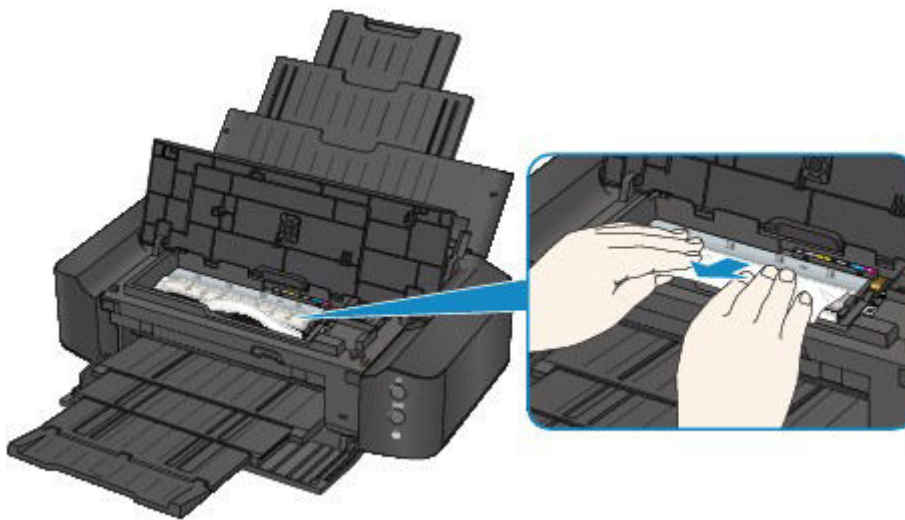

If the paper is rolled up, pull it out.

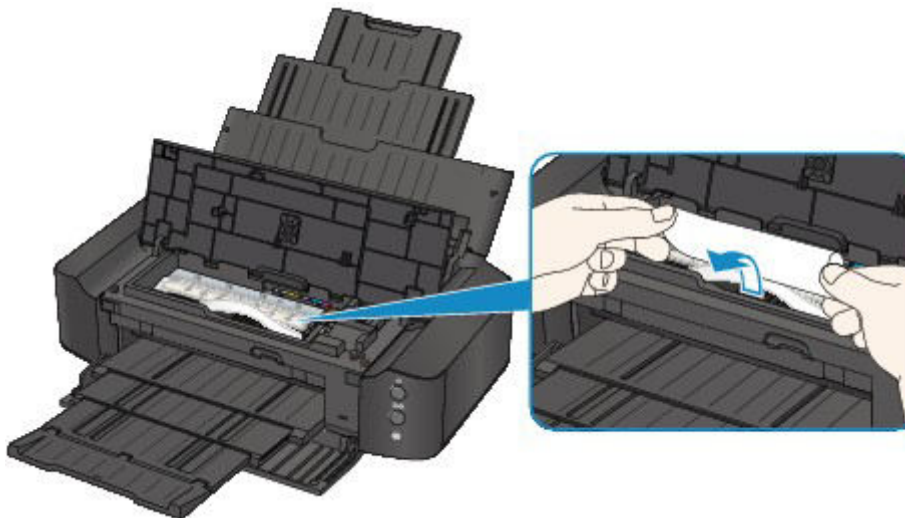

5. Pull the paper slowly not to tear it, then pull the paper out.

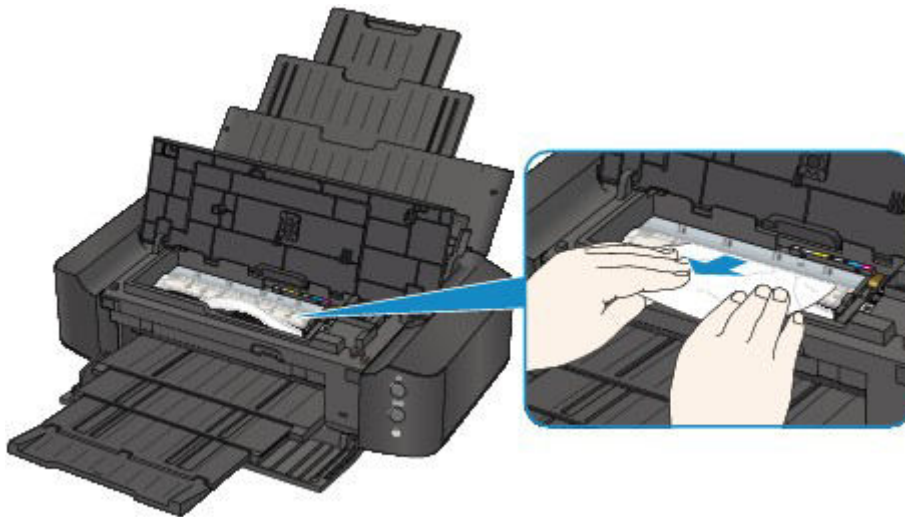

6. Make sure that all the jammed paper is removed.

If the paper is torn, a piece of paper may remain inside the printer. Check the following and remove the piece of paper if it remains.

- Does the piece of paper remain under the print head holder?
- Does the little piece of paper remain inside the printer?
- Does the piece of paper remain in the right side or the left side space (C) inside the printer?

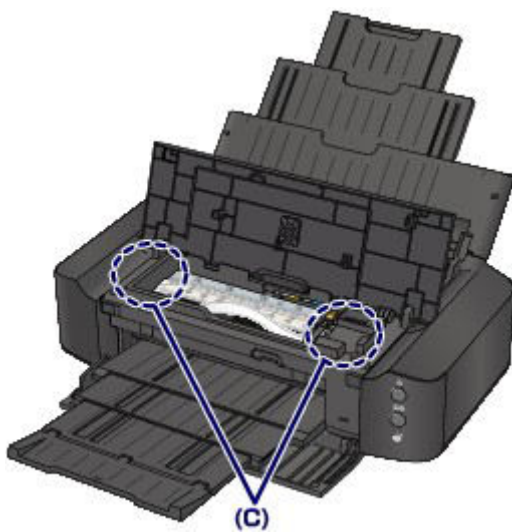

7. Close the top cover.

All print jobs in the queue are canceled. Reprint if necessary.

**Note**

- When reloading the paper, confirm that you are using the paper suited for printing and are loading it correctly. If the message about paper jam is displayed on the computer screen when you resume printing after removing all the jammed paper, a piece of paper may remain inside the printer. In this case, confirm that no piece of paper remains inside the printer.

If you cannot remove the paper or the paper tears inside the printer, or if the paper jam error continues after removing the paper, contact the service center.

## In Other Cases

Make sure of the following:

**Check1** Are there any foreign objects around the paper output slot?

**Check2** Are there any foreign objects in the rear tray?

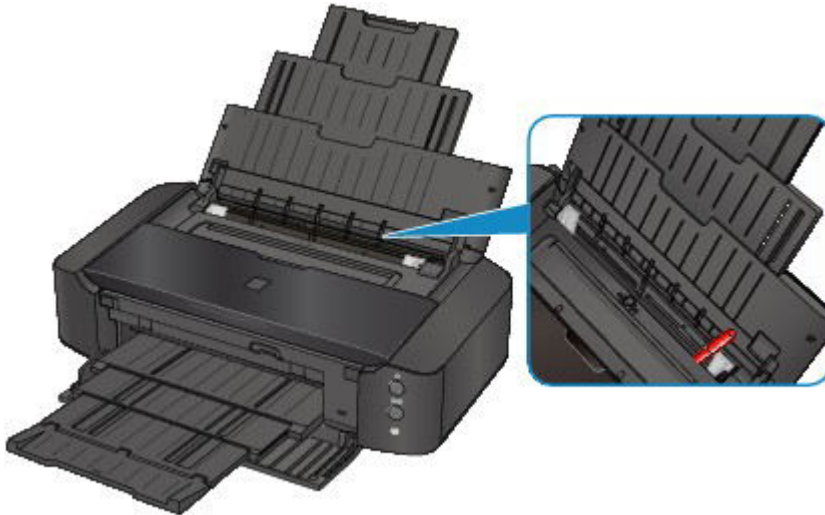

If there are any foreign objects in the rear tray, be sure to turn off the printer, unplug it from the power supply, then remove the foreign object.



**Check3** Is the paper curled?

Load the paper after correcting its curl.

**Check4** Is the loaded paper the A3 sized plain paper?

Only when A3 sized plain paper jams frequently near the paper output slot or is curled, set to the printer to prevent paper jam with the printer driver.

Print speed or print quality may be reduced if you apply the setting to prevent paper jam.

\* Readjust the setting not to prevent paper jam once printing is complete. If not, this setting remains enabled for all subsequent print jobs.

- In Windows:



Open the printer driver setup window, and in **Custom Settings** in the **Maintenance** sheet, select the **Prevent paper jam** check box, and then click **OK**.

- In Mac OS:

In the Canon IJ Printer Utility, select **Custom Settings** in the pop-up menu, select the **Prevent paper jam** check box, and then click **Apply**.

# 1000

## Cause

There is no paper in the rear tray.

## Action

Load paper in the rear tray and press the printer's **RESUME/CANCEL** button.

# 1001

## Cause

There is no disc tray.

## Action

When printing on printable discs (BD/DVD/CD, etc.), use the disc tray supplied with this printer ("L" is on the upper side). Place a printable disc on the disc tray, attach the disc tray to the printer, then press the printer's **RESUME/CANCEL** button.

## 1002

### Cause

Printable disc (BD/DVD/CD, etc.) is not set.

### Action

When printing on printable discs, use the disc tray supplied with this printer ("L" is on the upper side).

Place a printable disc on the disc tray, attach the disc tray to the printer, then press the printer's **RESUME/CANCEL** button.

## **1200**

### **Cause**

The top cover is open.

### **Action**

Close the top cover and wait for a while.

## **1250**

### **Cause**

The front cover is closed.

### **Action**

Open the front cover to resume printing.

## **1401**

### **Cause**

The print head may be damaged.

### **Action**

Contact the service center.

## **1403**

### **Cause**

The print head may be damaged.

### **Action**

Contact the service center.



## **1405**

### **Cause**

The print head may be damaged.

### **Action**

Contact the service center.

## **1410**

### **Cause**

The ink tank cannot be recognized.

### **Action**

Open the top cover and replace the ink tank which lamp is off.

## 1411

### **Cause**

The ink tank cannot be recognized.

### **Action**

Open the top cover and replace the ink tank which lamp is off.

## 1412

### **Cause**

The ink tank cannot be recognized.

### **Action**

Open the top cover and replace the ink tank which lamp is off.

## 1413

### **Cause**

The ink tank cannot be recognized.

### **Action**

Open the top cover and replace the ink tank which lamp is off.

**1414**

**Cause**

The ink tank cannot be recognized.

**Action**

Open the top cover and replace the ink tank which lamp is off.

## **1415**

### **Cause**

The ink tank cannot be recognized.

### **Action**

Open the top cover and replace the ink tank which lamp is off.

# 1600

## Cause

If the lamp on the ink tank is flashing, ink may have run out.

## Action

Replacing the ink tank is recommended.

If printing is in progress and you want to continue printing, press the printer's **RESUME/CANCEL** button with the ink tank installed. Then printing can continue. Replacing the ink tank is recommended after the printing. The printer may be damaged if printing is continued under the ink out condition.

### ▶▶ Note

- If multiple ink lamps are flashing red, check the status of each ink tank.



## **1660**

### **Cause**

The ink tank is not installed.

### **Action**

Install the ink tank.

## 1680

### **Cause**

Some ink tanks are not installed in the correct position. (The lamp on the ink tank flashes.)

### **Action**

Confirm that the ink tanks are installed in the appropriate positions.

## **1681**

### **Cause**

More than one ink tanks of the same color are installed. (The lamp on the ink tank flashes.)

### **Action**

Confirm that the ink tanks are installed in the appropriate positions.

## 1683

### Cause

The remaining ink level cannot be correctly detected. (The lamp on the ink tank flashes.)

### Action

Replace the ink tank and close the top cover.

Printing with an ink tank that was once empty may damage the printer.

If you want to continue printing in this condition, you need to release the function for detecting the remaining ink level. Press and hold the printer's **RESUME/CANCEL** button for at least 5 seconds, and then release it.

With this operation, releasing the function for detecting the remaining ink level is memorized. Please be advised that Canon shall not be liable for any printer malfunction or damage caused by refilled ink tanks.

## 1684

### Cause

The ink tank cannot be recognized.

### Action

Printing cannot be executed because the ink tank may not be installed properly or may not be compatible with this printer.

Install the appropriate ink tank.

If you want to cancel printing, press the printer's **RESUME/CANCEL** button.

# 1688

## Cause

The ink has run out. (The lamp on the ink tank flashes.)

## Action

Replace the ink tank and close the top cover.

Printing under the current condition may damage the printer.

If you want to continue printing in this condition, you need to release the function for detecting the remaining ink level. Press and hold the printer's **RESUME/CANCEL** button for at least 5 seconds, and then release it.

With this operation, releasing the function for detecting the remaining ink level is memorized. Please be advised that Canon shall not be liable for any malfunction or trouble which may be caused by continuation of printing under the ink out condition.

## 1700

### Cause

The ink absorber is almost full.

### Action

Press the printer's **RESUME/CANCEL** button to continue printing. Contact the service center.

# 1701

## Cause

The ink absorber is almost full.

## Action

Press the printer's **RESUME/CANCEL** button to continue printing. Contact the service center.



## 1830

### Cause

A certain period of time has elapsed while disc label printing is in progress.

### Action

If a certain period of time has elapsed while disc label printing is in progress, the printer stops initializing.

The printer resumes initializing by pressing the **RESUME/CANCEL** button.

Try the operation again following the on-screen instructions.

## 1850

### Cause

The disc tray guide is closed.

### Action

Open the disc tray guide, attach the disc tray properly, then press the printer's **RESUME/CANCEL** button.

# 1851

## Cause

The disc tray guide is open.

## Action

When printing other than disc label printing is started, close the disc tray guide.

Close the disc tray guide, then press the printer's **RESUME/CANCEL** button.

## 1855

### Cause

The disc tray guide has been closed.

### Action

Open the disc tray guide, then press the printer's **RESUME/CANCEL** button.

Do not open or close the disc tray guide while printing is in progress. Doing so may damage the printer.

## 1856

### Cause

The disc tray guide has been opened.

### Action

While printing other than disc label printing, close the disc tray guide.

Close the disc tray guide, then press the printer's **RESUME/CANCEL** button.

Do not open or close the disc tray guide while printing is in progress. Doing so may damage the printer.

## 1857

### **Cause**

The disc tray guide is open when starting disc label printing.

### **Action**

When starting disc label printing, close the disc tray guide for the printer to prepare to print.

Close the disc tray guide, then press the printer's **RESUME/CANCEL** button.

## 1858

### Cause

The disc tray guide is open after replacing the ink tank.

### Action

After replacing the ink tank, close the disc tray guide and the top cover.

Press the printer's **RESUME/CANCEL** button to dismiss the error.

## 2100

### Cause

The paper size in the print settings and the size of the loaded paper do not match.

### Action

Check the print settings and the loaded paper, load paper of the correct size, then press the printer's **RESUME/CANCEL** button.

If you want to cancel printing, press the printer's **RESUME/CANCEL** button again while the **POWER** lamp is flashing.



## 2101

### Cause

The paper size in the print settings and the size of the loaded paper do not match.

### Action

Check the print settings and the loaded paper, load paper of the correct size, then press the printer's **RESUME/CANCEL** button.

If you want to cancel printing, press the printer's **RESUME/CANCEL** button again while the **POWER** lamp is flashing.

## 2102

### Cause

The printer has detected that the paper has been fed aligned to one side.

### Action

Load the paper into the center of the rear tray, then slide the paper guides to align with the both edges of the paper stack.

Press the printer's **RESUME/CANCEL** button to dismiss the error.

## 2103

### Cause

The printer cannot detect the paper size.

### Action

Press the printer's **RESUME/CANCEL** button to dismiss the error, then try to print again.

If this error still occurs even after printing again, set the printer not to detect the paper width by using the printer driver or Remote UI.

### ▶▶ Note

- Depending on the type of paper, the printer may not detect the paper width.  
Additionally, if the top cover is opened while printing is in progress, the printer may not detect the paper width.

## 2500

### Cause

The cause of following may have occurred the failure of Automatic Print Head Alignment.

- Print head nozzles are clogged.
- The paper of size other than A4 or Letter is loaded.
- The paper output slot is exposed to strong light.

### Action

Press the printer's **RESUME/CANCEL** button to dismiss the error, then take the actions described below.

- Print the nozzle check pattern to check the status of the print head.
- Load one sheet of A4/Letter-sized plain paper and perform Automatic Print Head Alignment again.
- Adjust your operating environment and/or the position of the printer so that the paper output slot is not exposed directly to strong light.

After carrying out the above measures, if the problem continues after aligning the print head again, press the printer's **RESUME/CANCEL** button to dismiss the error, and then perform Manual Print Head Alignment.

## **4100**

### **Cause**

The specified data cannot be printed.

### **Action**

When you print the contents on CREATIVE PARK PREMIUM, confirm the message on the computer screen, make sure that genuine Canon ink tanks are installed properly for all colors, then start printing again.

## 4103

### **Cause**

Cannot perform printing with the current print settings.

### **Action**

Press the printer's **RESUME/CANCEL** button, to cancel printing.

Then, change the print settings and print again.

## 5100

### Cause

Printer error has occurred.

### Action

Cancel printing, and turn off the printer. Then clear the jammed paper or protective material that is preventing the print head holder from moving, and turn on the printer again.

If the problem is not resolved, contact the service center.

### ►► Important

- When you clear the jammed paper or protective material that is preventing the print head holder from moving, be careful not to touch the components inside the printer. The printer may not print out properly if you touch it.

## 5101

### Cause

Printer error has occurred.

### Action

Remove the protective material, turn the printer off, and turn it back on.

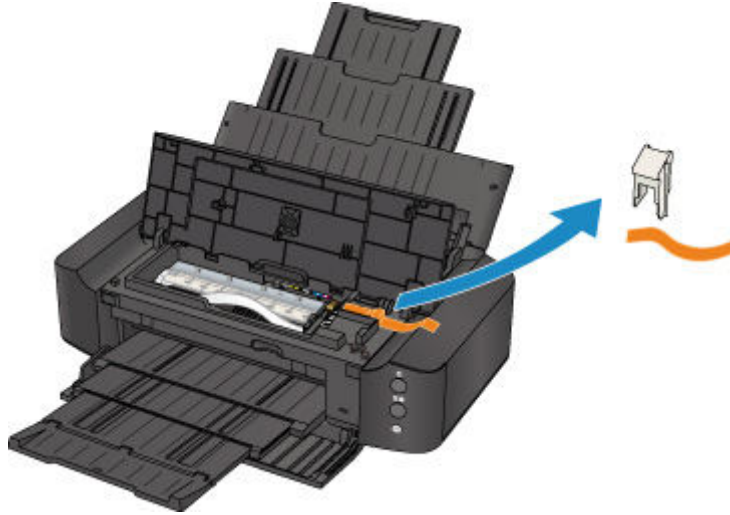

If the problem is not resolved, contact the service center.



## **5200**

### **Cause**

Printer error has occurred.

### **Action**

Turn off the printer, and unplug the power cord of the printer from the power supply.

Plug the printer back in and turn the printer back on.

If the problem is not resolved, contact the service center.

## **5400**

### **Cause**

Printer error has occurred.

### **Action**

Turn off the printer, and unplug the power cord of the printer from the power supply.

Plug the printer back in and turn the printer back on.

If the problem is not resolved, contact the service center.

## **5700**

### **Cause**

Printer error has occurred.

### **Action**

Turn off the printer, and unplug the power cord of the printer from the power supply.

Plug the printer back in and turn the printer back on.

If the problem is not resolved, contact the service center.

## **5B00**

### **Cause**

Printer error has occurred.

### **Action**

Contact the service center.

## **5B01**

### **Cause**

Printer error has occurred.

### **Action**

Contact the service center.

## **5C00**

### **Cause**

Printer error has occurred.

### **Action**

Turn off the printer, and unplug the power cord of the printer from the power supply.

Plug the printer back in and turn the printer back on.

If the problem is not resolved, contact the service center.

## **5C20**

### **Cause**

Printer error has occurred.

### **Action**

Turn off the printer, and unplug the power cord of the printer from the power supply.

Plug the printer back in and turn the printer back on.

If the problem is not resolved, contact the service center.

## **6000**

### **Cause**

Printer error has occurred.

### **Action**

Turn off the printer, and unplug the power cord of the printer from the power supply.

Plug the printer back in and turn the printer back on.

If the problem is not resolved, contact the service center.



## 6001

### Cause

Printer error has occurred.

### Action

If the front cover is closed, open it.

Turn off the printer, and unplug the power cord of the printer from the power supply.

Plug the printer back in and turn the printer back on.

If the problem is not resolved, contact the service center.

### ►► Important

- Do not close the front cover while the printer is in operation; otherwise, an error will occur.

## **6500**

### **Cause**

Printer error has occurred.

### **Action**

Turn off the printer, and unplug the power cord of the printer from the power supply.

Plug the printer back in and turn the printer back on.

If the problem is not resolved, contact the service center.

## **6502**

### **Cause**

Printer error has occurred.

### **Action**

Turn off the printer, and unplug the power cord of the printer from the power supply.

Plug the printer back in and turn the printer back on.

If the problem is not resolved, contact the service center.

## **6800**

### **Cause**

Printer error has occurred.

### **Action**

Turn off the printer, and unplug the power cord of the printer from the power supply.

Plug the printer back in and turn the printer back on.

If the problem is not resolved, contact the service center.

## **6801**

### **Cause**

Printer error has occurred.

### **Action**

Turn off the printer, and unplug the power cord of the printer from the power supply.

Plug the printer back in and turn the printer back on.

If the problem is not resolved, contact the service center.

## **6900**

### **Cause**

Printer error has occurred.

### **Action**

Turn off the printer, and unplug the power cord of the printer from the power supply.

Plug the printer back in and turn the printer back on.

If the problem is not resolved, contact the service center.

## **6901**

### **Cause**

Printer error has occurred.

### **Action**

Turn off the printer, and unplug the power cord of the printer from the power supply.

Plug the printer back in and turn the printer back on.

If the problem is not resolved, contact the service center.

## **6902**

### **Cause**

Printer error has occurred.

### **Action**

Turn off the printer, and unplug the power cord of the printer from the power supply.

Plug the printer back in and turn the printer back on.

If the problem is not resolved, contact the service center.



## **6910**

### **Cause**

Printer error has occurred.

### **Action**

Turn off the printer, and unplug the power cord of the printer from the power supply.

Plug the printer back in and turn the printer back on.

If the problem is not resolved, contact the service center.

# 6911

## **Cause**

Printer error has occurred.

## **Action**

Turn off the printer, and unplug the power cord of the printer from the power supply.

Plug the printer back in and turn the printer back on.

If the problem is not resolved, contact the service center.

## **6930**

### **Cause**

Printer error has occurred.

### **Action**

Turn off the printer, and unplug the power cord of the printer from the power supply.

Plug the printer back in and turn the printer back on.

If the problem is not resolved, contact the service center.

## **6931**

### **Cause**

Printer error has occurred.

### **Action**

Turn off the printer, and unplug the power cord of the printer from the power supply.

Plug the printer back in and turn the printer back on.

If the problem is not resolved, contact the service center.

## **6932**

### **Cause**

Printer error has occurred.

### **Action**

Turn off the printer, and unplug the power cord of the printer from the power supply.

Plug the printer back in and turn the printer back on.

If the problem is not resolved, contact the service center.

## **6933**

### **Cause**

Printer error has occurred.

### **Action**

Turn off the printer, and unplug the power cord of the printer from the power supply.

Plug the printer back in and turn the printer back on.

If the problem is not resolved, contact the service center.

## **6940**

### **Cause**

Printer error has occurred.

### **Action**

Turn off the printer, and unplug the power cord of the printer from the power supply.

Plug the printer back in and turn the printer back on.

If the problem is not resolved, contact the service center.

## **6941**

### **Cause**

Printer error has occurred.

### **Action**

Turn off the printer, and unplug the power cord of the printer from the power supply.

Plug the printer back in and turn the printer back on.

If the problem is not resolved, contact the service center.



## **6942**

### **Cause**

Printer error has occurred.

### **Action**

Turn off the printer, and unplug the power cord of the printer from the power supply.

Plug the printer back in and turn the printer back on.

If the problem is not resolved, contact the service center.

## **6943**

### **Cause**

Printer error has occurred.

### **Action**

Turn off the printer, and unplug the power cord of the printer from the power supply.

Plug the printer back in and turn the printer back on.

If the problem is not resolved, contact the service center.

## **6944**

### **Cause**

Printer error has occurred.

### **Action**

Turn off the printer, and unplug the power cord of the printer from the power supply.

Plug the printer back in and turn the printer back on.

If the problem is not resolved, contact the service center.

## **6945**

### **Cause**

Printer error has occurred.

### **Action**

Turn off the printer, and unplug the power cord of the printer from the power supply.

Plug the printer back in and turn the printer back on.

If the problem is not resolved, contact the service center.

## **6946**

### **Cause**

Printer error has occurred.

### **Action**

Turn off the printer, and unplug the power cord of the printer from the power supply.

Plug the printer back in and turn the printer back on.

If the problem is not resolved, contact the service center.

## **6A80**

### **Cause**

Printer error has occurred.

### **Action**

Turn off the printer, and unplug the power cord of the printer from the power supply.

Plug the printer back in and turn the printer back on.

If the problem is not resolved, contact the service center.

## **6A81**

### **Cause**

Printer error has occurred.

### **Action**

Turn off the printer, and unplug the power cord of the printer from the power supply.

Plug the printer back in and turn the printer back on.

If the problem is not resolved, contact the service center.

## **6A90**

### **Cause**

Printer error has occurred.

### **Action**

Turn off the printer, and unplug the power cord of the printer from the power supply.

Plug the printer back in and turn the printer back on.

If the problem is not resolved, contact the service center.



## **B200**

### **Cause**

An error requiring you to contact the service center has occurred.

### **Action**

Turn off the printer, and unplug the power cord of the printer from the power supply.

Contact the service center.

## **C000**

### **Cause**

Printer error has occurred.

### **Action**

Turn off the printer, and unplug the power cord of the printer from the power supply.

Plug the printer back in and turn the printer back on.

If the problem is not resolved, contact the service center.