

WASHING MACHINE >

User Manual

Model Numbers:

W814FGHDW

W814FGHDS

W814FGHDB

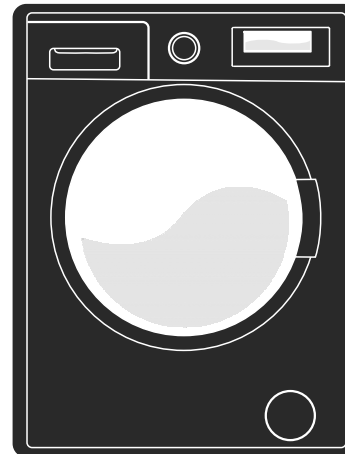

SERVIS
EFFICIENCY BY DESIGN

Visit servis.co.uk



Contents ›

- 01 Welcome
- 02 Safety Instructions
- 05 Your Washing Machine
- 08 Technical Specification
- 09 Installation
- 17 Setting Up
- 25 Usage
- 47 Maintenance
- 53 Clothing Care
- 57 Troubleshooting
- 61 Guarantee
- 63 Index

WELCOME >

WELCOME >

Thank you for choosing this Servis Washing Machine, which has been designed and manufactured to give you many years of trouble-free service.

You may already be familiar with using a similar product but please take time to read these instructions, which have been written to ensure you get the very best from your purchase.

HYDRODRIVE TECHNOLOGY > HYDRO DRIVE

HydroDrive Technology allows your Washing Machine to offer a rapid 12-minute wash programme by pumping water and detergent into the drum through two nozzles instead of the traditional one. This means that you'll be able to cut energy usage and reduce water consumption.

WARRANTY >

Servis provides you with a guarantee which will protect you should your Washing Machine develop an electrical or mechanical fault during the guarantee period. To ensure that you get a prompt and efficient service, please register your Washing Machine immediately. You will find a warranty card included within the packaging. To register, complete the form, or:

- » Visit us at www.servis.co.uk
- » Call us on 0333 577 7232

SAFETY INSTRUCTIONS >

ITEMS INCLUDED >

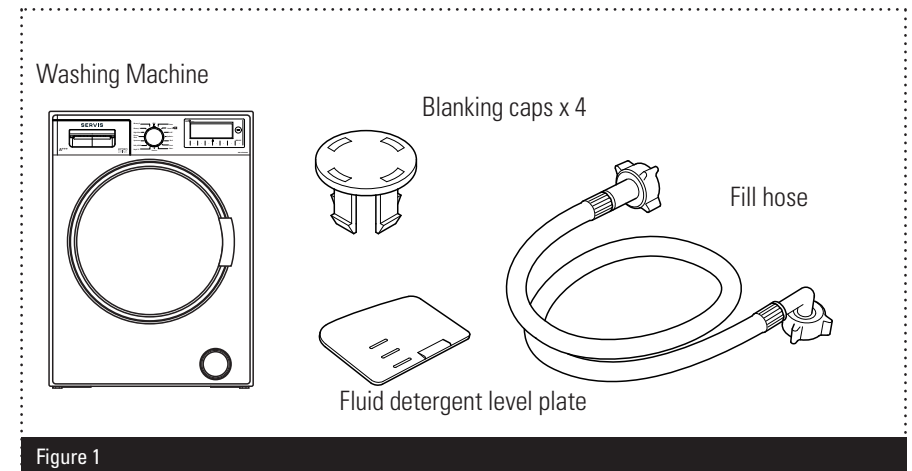

SAFETY INSTRUCTIONS >

To ensure your safety and the safety of others, please read the following safety precautions before you operate your Washing Machine.

- » Your Washing Machine conforms to current safety requirements. Inappropriate use can, however, lead to personal injury and damage to property. To avoid the risk of accidents and damage to your Washing Machine, read this user guide carefully before using it for the first time. It contains important information on the installation, safety, use and maintenance of your Washing Machine. Retain this user guide for future use and pass it on to any new owners.
Read this user guide before using or installing your Washing Machine.

SAFETY INSTRUCTIONS ›

- » Your Washing Machine is for domestic use only and is only intended to wash items which are specified by the manufacturer to be machine washable on the label, and textiles composed of hand washable wool or wool blend fabrics as well as satin, lace, silk and other hand-washable garments. Do not use your Washing Machine for any purpose not expressly specified in this user guide.
- » This appliance can be used by children aged from 8 years and above and persons with reduced physical, sensory or mental capabilities or lack of experience and knowledge if they have been given supervision or instruction concerning use of the appliance in a safe way and understand the hazards involved. Children shall not play with the appliance. Cleaning and user maintenance shall not be made by children without supervision.
- » Before setting up your Washing Machine, check for any external visible damage. Do not install or use your Washing Machine if it is damaged.
- » Before setting up your Washing Machine, remove the four transit bolts and the rubber washers from the back of the machine (refer to page 9).
- » Before connecting your Washing Machine, ensure that the information on the data plate (voltage and connected load) matches that of the mains electricity supply. If in doubt, consult a qualified electrician.
- » Do not connect your Washing Machine to the mains electricity supply using an extension lead.
- » A damaged power cord/plug can cause fire or give you an electric shock. When damaged it must be replaced, this should only be done by qualified personnel.
- » Never remove the plug from the socket by pulling the cord. Always hold the plug.
- » Never touch the power cord/plug with wet hands as this could cause a short circuit or electric shock.
- » Do not touch your Washing Machine if your hands or feet are wet.
- » Never open the detergent drawer while the machine is running.
- » Faulty components must only be replaced by a suitably qualified Service Agent using genuine spare parts.
- » Unauthorised repairs could result in unforeseen dangers for the user. Repairs should only be undertaken by an approved service agent.
- » In the event of a fault or for cleaning purposes, your Washing Machine is only completely isolated from the electricity supply when it is unplugged from the mains.
- » Your Washing Machine must only be connected to your water supply using the supplied new fill hose. Old hoses must not be reused.
- » Do not make any alterations to your Washing Machine, unless authorised to do so by Servis.
- » The packaging of the machine could be hazardous to children. Please refer to the disposal instructions on the rear cover.
- » Please ensure that you have removed all of the packaging materials and protective tape from the outside of your Washing Machine, inside the drum and inside the detergent drawer before using.

YOUR WASHING MACHINE >

FRONT VIEW >

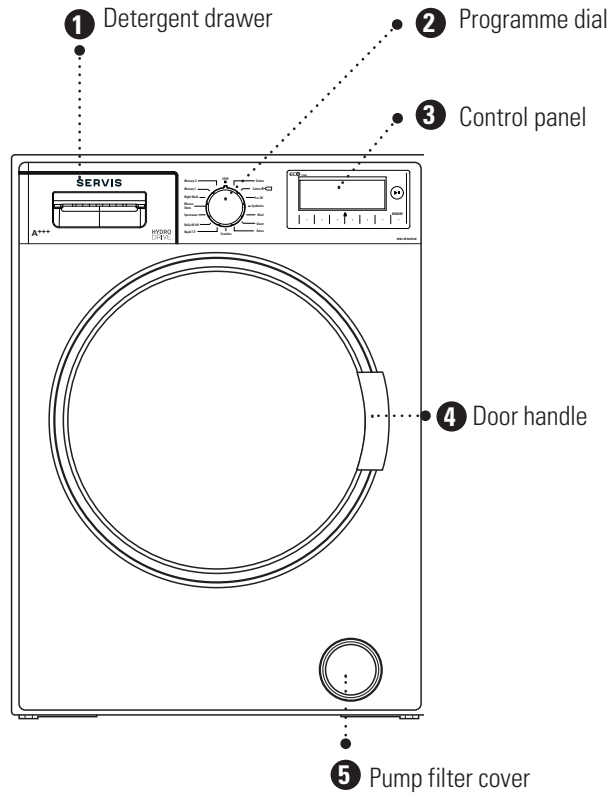

- 1 Detergent drawer; Allows you to insert detergent, fabric conditioner and starch.
- 2 Programme dial; Allows you to select the programme for your wash.
- 3 Control panel; Allows you to configure the required settings for your wash.
- 4 Door handle; Provides you with access to the drum.
- 5 Pump filter cover; Provides access to the pump filter for maintenance purposes.

Figure 2

REAR VIEW >

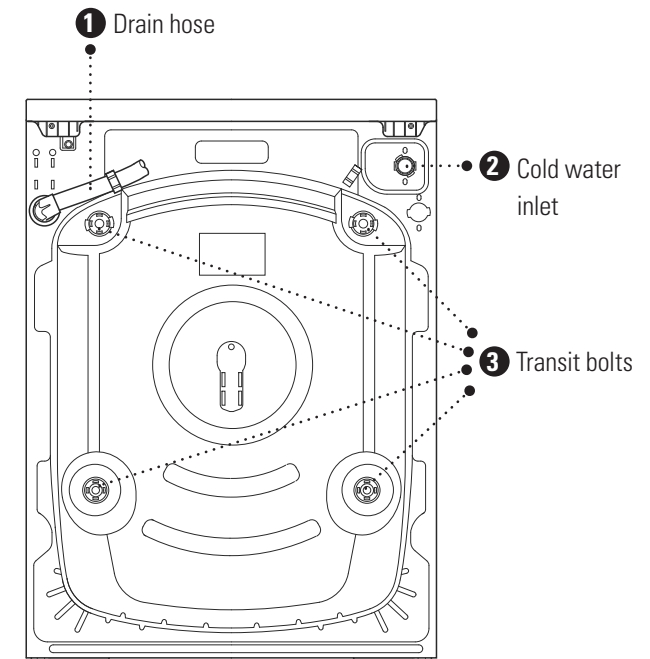



- 1 Drain hose; Provides an outlet for the dirty water from your Washing Machine.
- 2 Cold water inlet; Connects your Washing Machine to your cold water supply.
- 3 Transit bolts; Remove before first use of your Washing Machine (refer to page 9).

Figure 3

DETERGENT DRAWER >

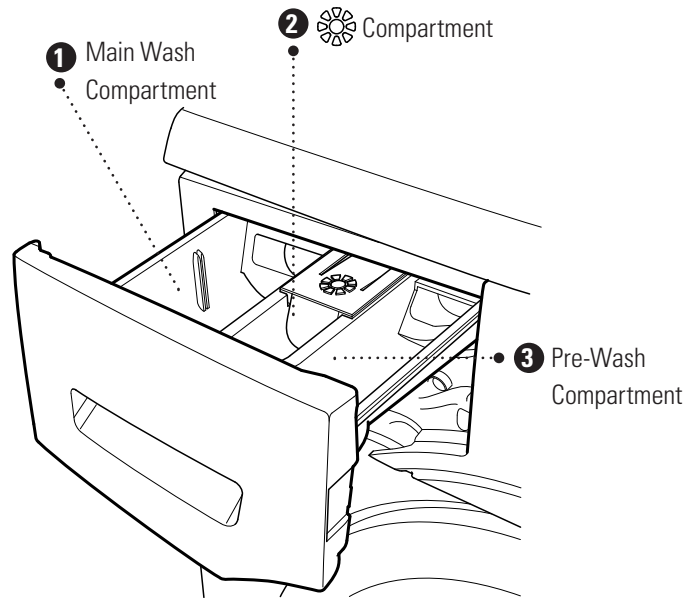
TECHNICAL SPECIFICATION >



- 1 Main Wash Compartment; Add detergent for the main wash.
- 2  Compartment; For fabric conditioner and liquid starch.
- 3 Pre-Wash Compartment; Add detergent for the pre-wash.

Voltage V/Frequency (Hz)	220-240V/50Hz
Electrical Current (A)	10
Power Rating (W)	2200
Water Consumption (Cotton 60° Full load) (L/Cycle)	48
Energy Consumption (Cotton 60° Full load) (kWh/Cycle)	0.76
Unpacked Dimensions (H x W x D) (cm)	84.5 x 59.7 x 58.7
Gross Weight (kg)	81.5
Spin Speed (rpm)	1400
Drum Volume (lt)	60
Max Dry Load Capacity (kg)	8
Energy Rating	A+++
Wash Noise (dB)	58
Spin Noise (dB)	78

Figure 4

INSTALLATION >

INSTALLATION REQUIREMENTS >

To avoid risk of injury, please take care when moving your Washing Machine. It is heavy and we recommend that a minimum of two people move your Washing Machine.

To unpack your Washing Machine and manoeuvre it to the installation area, one person should hold it by the front feet and the other person at the edge of the lid at the rear.

Your Washing Machine measures 84.5 x 59.7 x 58.7cm and will require an installation area with the space to allow the door to fully open and provide easy access to the plumbing and electrical connections.

The most suitable installation surface for your Washing Machine is a concrete floor as it is less prone to vibration during the spin cycle. Soft floor surfaces such as carpets and rugs are not suitable.

If you have to install your Washing Machine on a wooden floor, we recommend that a water-resistant wooden base at least 30mm thick is installed. The base should span several joists and be bolted down. Check for the presence of pipes and cables before installing.

If possible, install your Washing Machine in the corner of the room as it is often the most stable part of the floor.

Do not install your Washing Machine in rooms where temperatures below freezing may occur as frozen hoses may burst or split.

REMOVAL OF TRANSIT BOLTS >

The transit bolts are used to protect your Washing Machine from damage during transportation and must be removed before using your Washing Machine for the first time. Keep the transit bolts safe and re-fit them if you need to transport your Washing Machine in the future.

The four transit bolts are located on the back of your Washing Machine (fig 5a).

To remove the transit bolts (4 off):

- 1 Remove each bolt by turning anti-clockwise with a suitable spanner (fig 5b).

- 2 Pull out the remaining plastic section of each transit bolt by hand. This will require a reasonable amount of force (fig 5c).
- 3 Insert the blanking caps (4 off): Push the cap into the hole until the four connectors click into place. Check that the cap is flush with the machine.

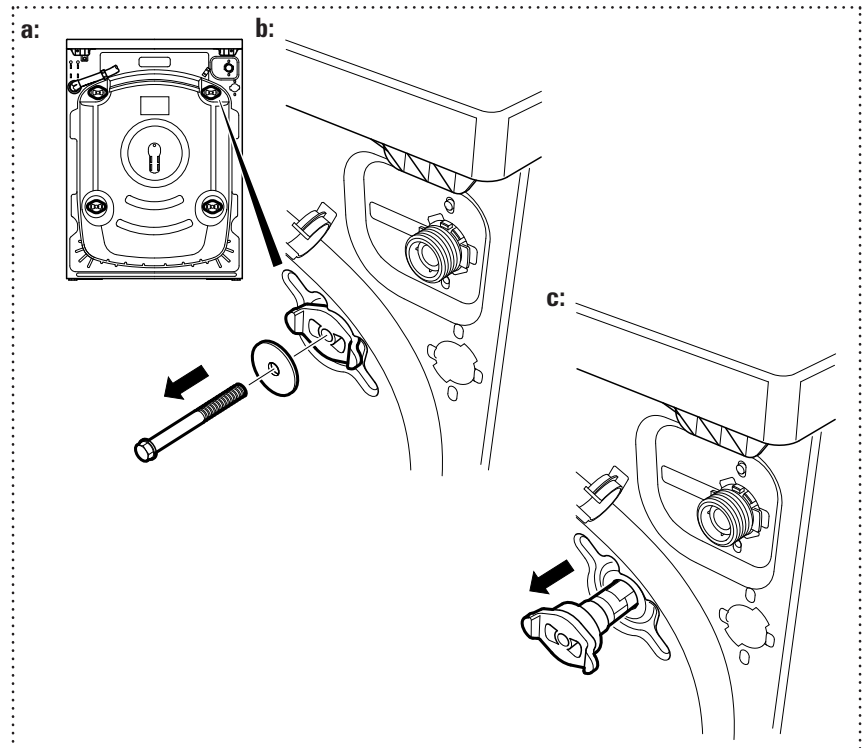

Figure 5

To re-fit the transit bolts (4 off) for future transportation:

- 1 Pull and remove the four plastic blanking caps.
- 2 Insert the plastic sections of the transit bolts into the exposed holes.
- 3 Insert the bolts into the plastic sections of the transit bolts and tighten with a suitable spanner until secure.

INSTALLATION >

ADJUSTING THE FEET >

For safe operation, it is important that your Washing Machine is level and securely positioned on all four feet. Incorrect installation may cause the Washing Machine to vibrate and increase your water and electricity consumption.

The four adjustable feet are used to level the Washing Machine. To adjust the feet:

- 1 Loosen the plastic locking nut by turning anti-clockwise (fig 6a).
- 2 To increase the height of the machine, turn the feet clockwise (fig 6b).
- 3 To decrease the height of the machine, turn the feet anti-clockwise (fig 6b).
- 4 After making adjustments, use a spirit level to check that the machine is level.
- 5 Once the machine is level, tighten the locking nuts by turning clockwise (fig 6c).

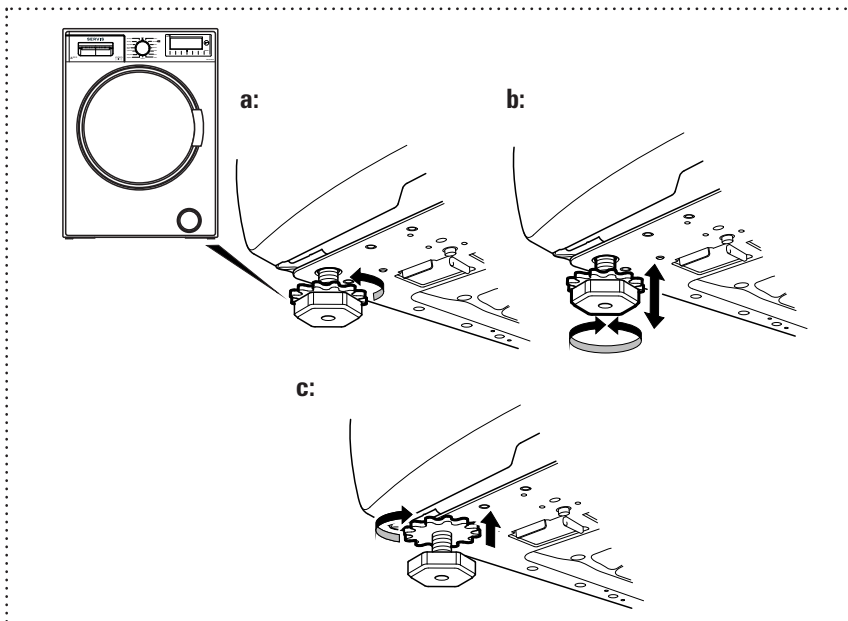

Figure 6

WATER SUPPLY CONNECTION >

Your Washing Machine uses an energy efficient cold fill system, which means that only the water required to wash the laundry is heated. As a result, no heat is lost in the pipeline from the hot water supply.

Connect your Washing Machine to your cold water supply only. If your previous machine had a hot and cold fill, check that the hot tap on your water supply is closed to avoid leakage. Only use the fill hose supplied and not one from your old Washing Machine. Only one hose is required to install your Washing Machine to the cold water supply. The inlet hose provided with your Washing Machine connects the rear of your machine and the cold water supply.

To connect your Washing Machine to the cold water supply:

- 1 Connect the angled end of the fill hose to the cold water inlet on the rear of your Washing Machine by screwing the threaded connector clockwise (fig 7). Take care not to overtighten the connection. Hand tight is sufficient.

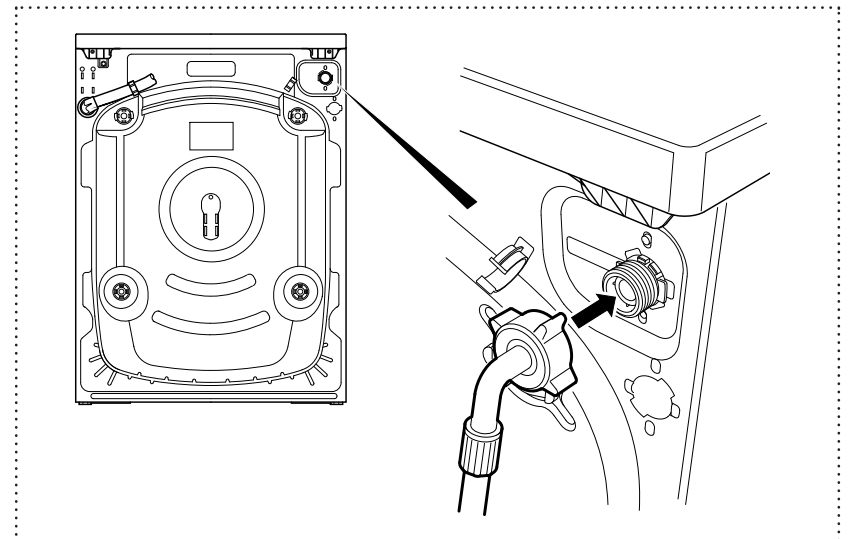

Figure 7

INSTALLATION >

WATER SUPPLY CONNECTION >

- 2 Screw the straight end of the hose clockwise to a 19mm (3/4") cold water tap until hand tight (fig 8). Take care not to trap or kink the hose.

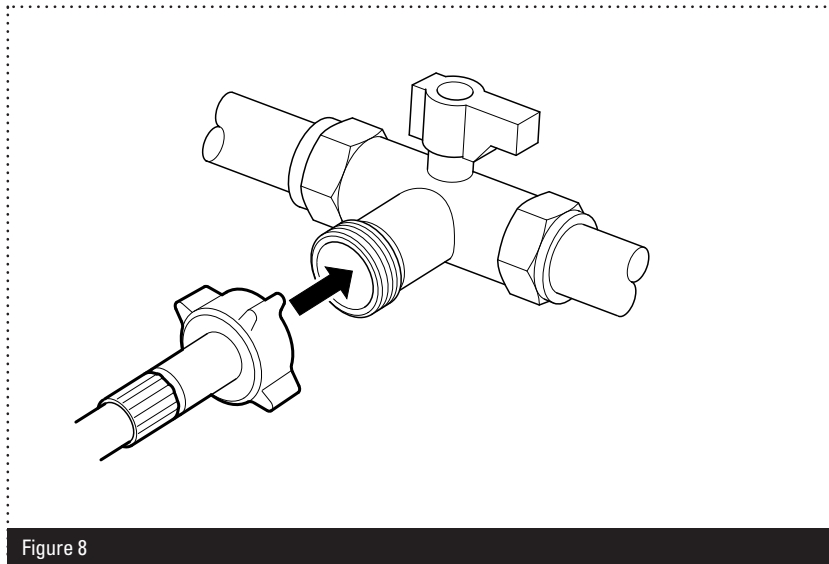

Figure 8

DRAIN HOSE CONNECTION >

Do not connect your Washing Machine to a surface water drain.
Connect your Washing Machine to your household drainage system (fig 9).
For your Washing Machine to function properly the outlet end of the drain hose must be at a minimum of 60cm and a maximum of 100cm from the ground.

CAUTION: Check to ensure that the hose is not trapped, kinked, twisted, folded or crushed.
Do not attempt to extend the drain hose by adding extra sections.

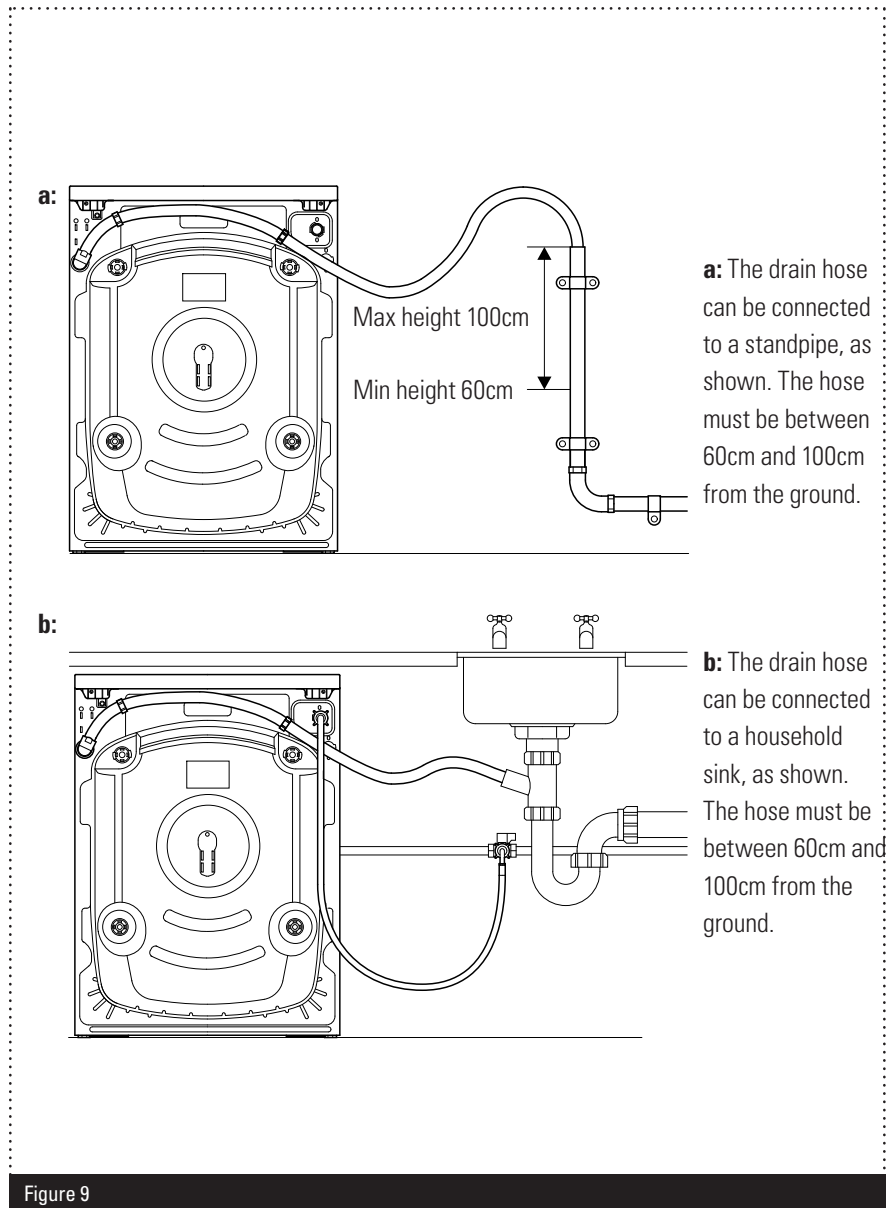

Figure 9

INSTALLATION >

The cold water pressure for a normal household system ranges from between 0.1 to 1 Mpa. Your Washing Machine will run at optimum efficiency in this range.

Once you have made all of the connections, carefully turn your cold water supply on and check for leaks.

ELECTRICAL CONNECTION >

- » Your Washing Machine requires a 220-240V, 50Hz mains supply. Do not use any other supply.
- » Your Washing Machine may be fitted with a moulded plug, which cannot be rewired.
- » If the fuse cover becomes damaged, you must not use the plug.
- » If your plug requires changing because it is not suitable for your socket, or it is damaged, you should consult a qualified electrician.

Fuse:

- » Replacement fuses should be ASTA-approved to BS1362 and have the correct 10 Amp rating.
- » Replacement fuses can be purchased from an electrical supplier.

SETTING UP >

CONTROL PANEL OVERVIEW >

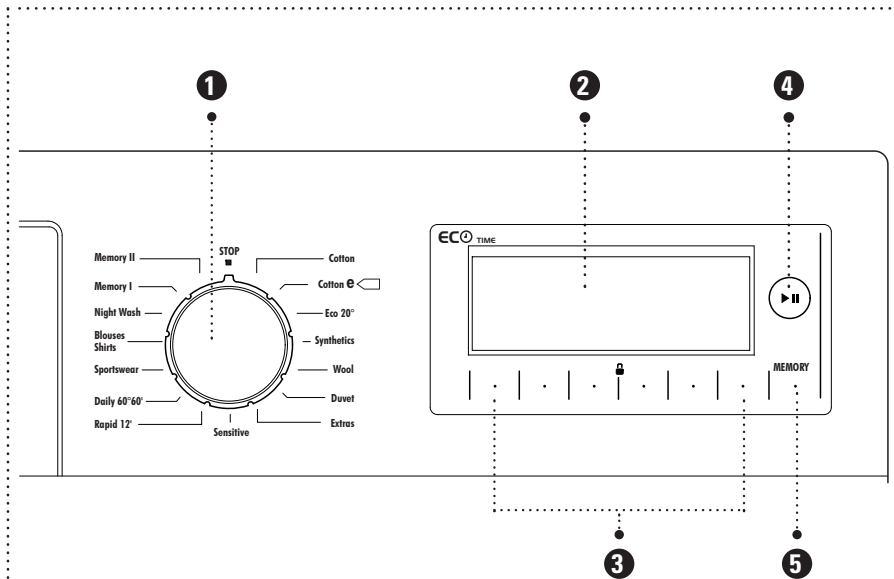

- 1 Programme Dial; Used to select a washing programme (see page 29).
- 2 Information Screen; Displays details of the selected programme and information on the status of your Washing Machine.
- 3 Smart Touch Function Buttons: Used to select or adjust a particular function.
- 4 Start/Pause Button: Used to Start or Pause the selected programme.
- 5 Memory Button: Used to store preferred settings (see page 40).

USING THE SMART TOUCH BUTTONS >

A series of 6 smart touch buttons can be found below the information screen. To make a selection, press the button below the desired selection choice on the information screen. For example, if the instructions in this user manual say 'Press the ✓ button' press the button directly below the ✓ symbol.

SETTING UP YOUR WASHER DRYER >

Your Washing Machine has a range of adjustable features that can be altered to suit your preferences. To make the initial settings please ensure that:

- 1 The transit bolts have been removed.
- 2 Your Washing Machine has been correctly connected to your water supply and your water drainage system.
- 3 Your Washing Machine has been connected to an appropriate mains power supply and is switched on at the socket.
- 4 The programme dial is turned on (i.e. is not in the 'STOP' position).

Current Time Setting ⌚

We recommend that you set the correct time during the initial set-up of your Washing Machine. After turning your Washing Machine on for the first time it will check to see if you would like to set the current time 'set day time' will be displayed on the information screen (fig 11).

- » To set the current time, press the ✓ button. Alternatively, press the ✕ button to exit without setting the time.

Figure 10

SETTING UP >



Figure 11

If you have chosen to set the current time:

- » Press the > button under the hour setting until it displays the current hour.
- » Press the > button under the minute setting until the current time is shown.
- » To confirm the current time setting, press the ✓ button.

Once you have set the current time, your Washing Machine will automatically display the main screen of the programme selected by the programme dial. If you would like to make further changes to your settings, press the ≡ button and use the → button to select the setting you wish to alter.

You can change the current time setting at any time by pressing the ≡ button from the main programme screen and selecting the → button until the time is displayed. Use the > buttons to increase the hours and minutes.

Please Note: We strongly recommend that you set the current time accurately as other operating features depend on it.

Time setting information will be lost if you leave your Washing Machine unplugged for more than 15 days. In this case you will be prompted to set the time when you next turn your Washing Machine on.

Language Selection Setting

To select the language used on the information screen, press the ≡ button. When setting the language for the first time 'Select Language' will appear on the information screen (fig 12).

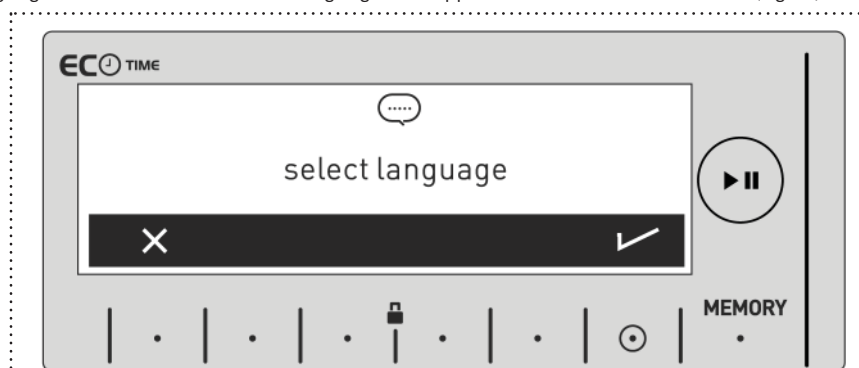

Figure 12

To change the current language setting press the ✓ button.

To exit the language selection screen without making a selection, press the ✕ button.

If you have chosen to change the current language setting:





- » You can cycle through the available languages using the < and > buttons.
- » Press the ✓ button to select the desired language.
- » You will be asked to confirm the language selected, for example 'Switch to Deutsch?'
- » Press the ✓ button to confirm the selection, or the ✕ button to cancel the selection and make another choice.

You can change the language at any time by pressing the ≡ button. The current language selection will be displayed, for example 'English'. Press the < and > buttons to cycle through the available languages and use the ✓ button to select your choice.

SETTING UP >

Eco Time Setting (Economic Time Interval) ^{ECO TIME}

To help make savings on your energy bills, your Washing Machine contains an Eco Time Setting. This allows you to set your Washing Machine to run during the hours when your electricity tariff is more economical. Please be aware that a smart counter will be required in order for this mode to work. When setting the Economic Time Interval for the first time:

- » Press the  button on the main programme screen and use the  button until ^{ECO TIME} and 'set economic time zone' is displayed on the information screen.
- » Press the  button to set Eco Time, or the  button to return to the main programme screen.

If you have chosen to set Eco Time:

- » ^{ECO TIME} and the start and end time of the economic time interval will be displayed on the information screen (fig 13).

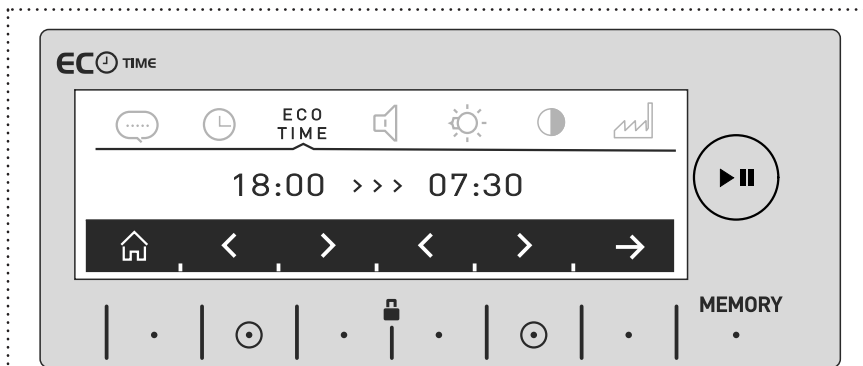









Figure 13











- » Use the  and  buttons to set the start and finish time for the economic time interval.
- » Press the  button to confirm the selection, or the  button to return to the main programme screen.

You can change the Eco Time hours at any time by pressing the  button from the main programme screen and using the  button until the Eco Time hours are displayed. Use the  and  buttons to set the desired Eco Time interval.

To activate the Eco-Time setting, please refer to the information on additional functions on page 53.





Sound Adjustment

You can choose to turn the warning sounds of your Washing Machine on or off. To access the sound settings:

- » Press the  button on the main programme screen and then press the  button until the sound adjustment settings are displayed. This is shown by the  and  symbols on the information screen. Alternatively, if you are already in the settings menu, use the  button to navigate to the sound adjustment settings.
- » Use either the  or  buttons to toggle the warning sounds on or off. A  symbol and 3 audible beeps indicates that the warning sounds are turned on. A  symbol indicates that the warning sounds are turned off.
- » To return to the main programme screen, press the  button, or press the  button.

Screen Brightness Setting

You can adjust the brightness setting of the information screen on your Washing Machine:

- » Press the  button on the main programme screen and then press the  button until the brightness setting screen is displayed. This is shown by the  symbol. Alternatively, if you are already in the settings menu, use the  button to navigate to the brightness settings.

SETTING UP >

- » Use the < button to decrease the brightness of the information screen, or the > button to increase the brightness. The information screen displays a bar showing the level of brightness selected (fig 14).

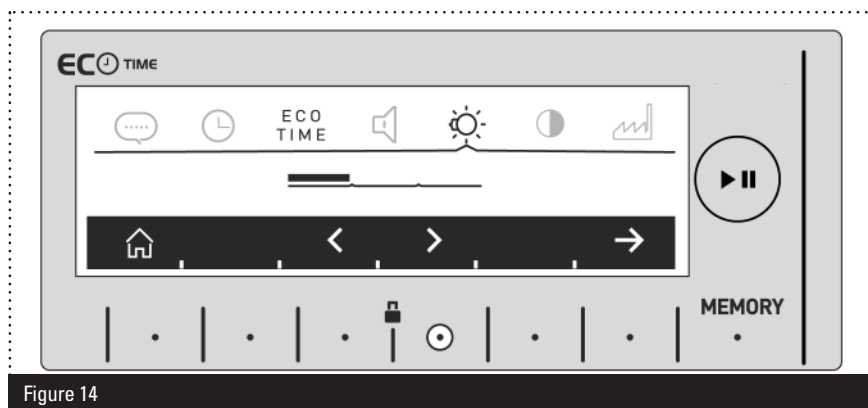

Figure 14

- » To return to the main programme screen press the Home button, or press the > button to select another setting you wish to alter.

Screen Contrast Setting

You can adjust the contrast of the information screen on your Washing Machine:

- » Press the Menu button on the main programme screen and then press the > button until the contrast setting screen is displayed. This is shown by the Contrast symbol. Alternatively, if you are already in the settings menu, use the > button to navigate to the contrast settings.
- » Use the < button to reduce the level of contrast, or the > button to increase the level of contrast.
- » To return to the main programme screen, press the Home button or press the > button to select another setting you wish to alter.

Revert to Factory Settings

You have the option to revert your Washing Machine to the factory default settings:

- » Press the Menu button on the main programme screen and then press the > button until the screen shown in fig 15 is displayed. If you are already in the setting menu, use the > button to navigate to the factory settings screen.

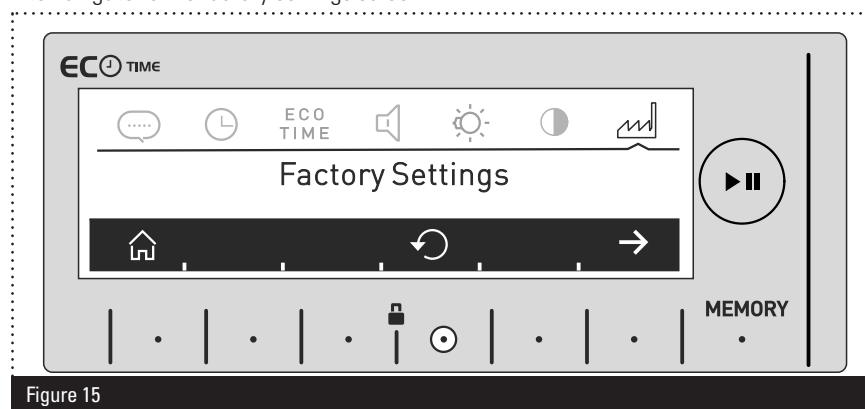

Figure 15

- » Press the Reset symbol to reset your Washing Machine to factory settings. You will be asked to confirm your choice. 'Reset to Factory Settings?' will be displayed on the information screen. Press the Checkmark button to confirm your selection or the X button to cancel.
- » You can return to the main programme screen by pressing the Home button.

RUNNING YOUR FIRST WASH >

Before using your Washing Machine for the first time; check that:

- 1 The transit bolts have been removed.
- 2 Your Washing Machine has been correctly connected to your water supply and your water drainage system.
- 3 Your Washing Machine has been connected to an appropriate mains power supply and is switched on at the socket.

Tests were carried out on your Washing Machine at the factory; as a result, water may be left in the machine. To remove any water we recommend that the first wash is carried out without any laundry:

- 1 Open the detergent drawer, pour in half a measuring cup of all-purpose detergent, close the drawer and select programme 1 (Cotton on the programme selection dial). If using a liquid detergent, refer to page 28 for details on how to insert the fluid level detergent plate.
- 2 Close the door until it clicks shut.
- 3 Press the Start/Pause button.

WASHING SEQUENCE >

Please follow the steps suggested below to get the best results from your washing.

Preparing Your Laundry:

CAUTION: Please be aware that any foreign objects such as coins or paper clips can cause damage to your garments and components in your Washing Machine.

- » Empty all pockets on items of clothing, brush out any sand and dirt from pockets and cuffs.

- » Close zips and fasten any hooks and eyes.
- » Items such as trousers, t-shirts, sweat shirts and knitted garments should be turned inside out.
- » Remove any weights from curtains, or place in a laundry bag.
- » Any loose wiring in bras and shirt collar stiffeners should be removed or sewn in.

Sorting Your Laundry:

- » Sort your laundry by colour. Always wash whites and coloureds separately.
- » Dark textiles may contain excess dye and should be washed separately several times before being included in a mixed load.
- » Follow the instructions given in the care labels on the clothing.
- » Do not wash any items in the machine that the manufacturer has specified as non-washable on the care label.
- » Badly soiled or stained areas can be pre-treated with liquid detergent or stain removers by following the manufacturer's instructions.
- » If you use a solvent-based cleaning agent to pre-treat a stain, protect any plastic parts such as buttons. Rinse the cleaning agent off before loading the washing into the machine.
- » Do not use a solvent-based cleaning agent in your Washing Machine.

Loading the Drum:

- 1 Pull the door open using the handle.
- 2 Load your items of clothing into the drum, ensuring they are loosely packed. You will achieve better wash results if you mix up large and small items. Items of varying size will help distribute the load more evenly during spinning.
- 3 Take care not to exceed the maximum load of the drum as this will give poor wash results and cause creasing. Refer to the table on pages 33 to 40 for information on load capacities.
- 4 Gently push the door until it clicks shut. Check that no items of clothing are trapped between the rubber seal and the door.

Half-Load Detection System:

Your Washing Machine features a half-load detection system. If you put less than half the maximum load of laundry into your Washing Machine it will automatically set the half-load function, regardless of the programme you selected. This means that the selected programme will take less time to complete and will use less water and energy.

Adding Detergent:

Please take care to add the correct amount of detergent to your Washing Machine.

If too little detergent is added:

- » Your laundry may not be washed properly and may become grey and stiff over time.
- » Spots of fat may appear on your laundry.
- » Limescale may form on the heater elements.

If too much detergent is added:

- » Excessive foam will be formed resulting in poor wash results.
- » Water consumption will increase.

You can use any detergent produced for automatic washing machines. The use of dispensing aids such as balls is recommended, if they are supplied with the detergent.

Tablets are suitable for full loads; however, it may be impractical to reduce them for smaller loads. Some tablets do not dissolve as quickly as others and may not be suitable for wash cycles of short duration.

It is possible to use fluid detergents in all programmes without a pre-wash. To do this, slide the fluid detergent level plate into the guides in compartment II of the detergent drawer (fig 16). Use the lines on the plate as a guide to fill the drawer to the required level.

The amount of detergent to use will depend on the dirtiness of your clothes and the hardness of your water supply; guidelines will be on the packaging of your detergent.

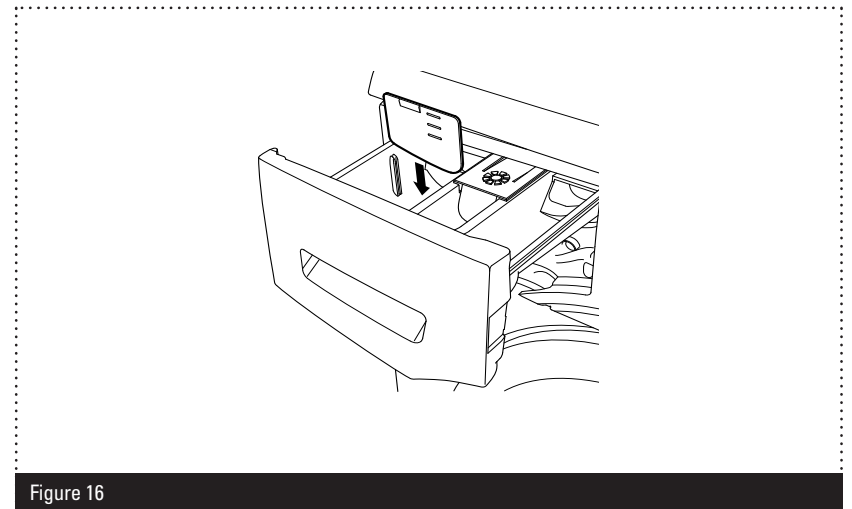

Figure 16

- » If your clothes are only slightly soiled, do not prewash and put a small amount of detergent, as specified by the manufacturer, into compartment II of the detergent drawer.
- » If your clothes are excessively soiled, select a programme with pre-wash and put $\frac{1}{4}$ of the detergent to be used into compartment I of the detergent drawer and the rest in compartment II.

Water Softener:

A water softener can be used to reduce the amount of detergent required in hard water areas. Follow the guidance on the packaging and dispense as instructed. First add the detergent, then the water softener.

Fabric Conditioners and Liquid Starch:

- » Fabric conditioners make garments soft to handle.
- » Starch stiffens and gives body to items such as bed linen.

To add fabric conditioner or liquid starch, pour the amount as instructed on the packaging into the  compartment of the detergent drawer, taking care not to exceed the MAX level.

Selecting a Programme:

To select the desired programme, turn the programme dial either clockwise or anti-clockwise until the marker on the dial points to the chosen programme.

The **Synthetics**, **Wool** and **Extras** options have sub-programmes. Press the < and > buttons to display the required sub-programme and press the → button to select it.

To cancel a programme, refer to the information on page 45.

Spin Speed Selector:

When you select a programme, the maximum spin speed is automatically selected. To adjust the spin speed, press the @ button until the desired speed is displayed. The spin speed of your Washing Machine ranges up to 1400 rpm. Refer to the table on page 42.

Temperature Selector:

When you select a programme, the maximum temperature is automatically selected. To adjust the temperature, press the ● button until the desired temperature is displayed on the digital display. Refer to the table on page 41.

Stain Removal Function:

Your Washing Machine features a stain removal system which can handle 22 different types of stain. Your Washing Machine automatically adjusts the washing temperature and the rinse duration according to the stain type selected.

Note: You cannot select the stain removal function with some wash programmes. Refer to the table on page 44.

For the stain removal function to work effectively, you should not let the stains on your laundry dry and stick and you should remove any solids before washing. Before you wash a stain you should press it once with a cloth, but do not rub the stain.



To select the stain removal function, press the  button once, then press the < and > buttons to select the required stain type. When you are finished press the ✓ button.

To cancel the stain removal function after you have entered it, press the  button again.

The stain types are:

1. Blood	9. Red wine	17. Sauce
2. Mud	10. Tomatoes	18. Chocolate
3. Socks	11. Tea	19. Deodorant
4. Baby food	12. Fruit	20. Lipstick
5. Sweat	13. Grass	21. Make-up
6. Egg	14. Collar grime	22. Mixed
7. Ice cream	15. Cuff grime	
8. Coffee	16. Oil	

Delay Programme Start:

Instead of starting the programme immediately you can set the programme to start automatically after a set period of time (from 10 minutes to 23 hours and 50 minutes) or a specific end time. To do so, press the  button once, then press the < and > buttons under either the delay or finish time to set the desired delay period or finish time. When you are finished press the  button.

Please Note: After selecting the delay function, you can select other additional functions before pressing the Start/Pause button to activate the delay function.

Cancelling the Delay Function:

To cancel the delay function after you have pressed the Start/Pause button, press the  button again.

Starting a Programme:

To start the selected programme, press the Programme Start/Pause button.

Electronic Display:

The electronic display on the control panel shows the following:

- » Water temperature
- » Spin speed
- » Remaining programme time
- » Whether or not the door is locked
- » Any auxiliary functions that have been selected

The progress bar at the top of the control panel shows the current stage of the selected programme.

Programme Summary:

Your Washing Machine is equipped with 18 pre-set programmes and two memory slots for you to store your own frequently-used programme settings. We have summarised some of the important information, making it as easy as possible for you to select the most appropriate programme for your laundry.

Day to day washing: Recommended Programmes: 2, 9, 10 and 12

These programmes are ideal for washing lightly soiled cottons and synthetics as separated or mixed washes. They often run at lower temperatures and can be used with the majority of detergents.

Programme 9 (Rapid 12 Min):

The fast wash speed of this programme is made possible by pumping water and detergent into the drum through two nozzles instead of one. The 12-minute wash is only intended for small loads and quick refreshes of laundry that is only very slightly dirty; ideal for the freshening up of a school uniform for example.

Heavily Soiled Washing: Recommended Programmes: 1 and 15

These programmes are ideal for washing heavily soiled cottons and synthetics and are capable of removing stubborn dirt and stains.

Delicate Washing: Recommended programmes 4 and 5

These programmes are ideal for washing items such as delicate synthetics, wool and silk. Lower temperatures are used.

You can find detailed information on all washing programmes in the table on pages 33 to 40.

USAGE >

Programme Modes:

Please Note: Programme duration might change according to the load, ambient temperature and selected additional functions.

Settings in **bold** are factory presets.

1. Cotton 90°

Washing Temperature (°C)	90° , 80°, 70°, 60°, 50°, 40°, 30°, --
Maximum Dry Load (kg)	8
Detergent Compartment	II
Programme Duration (minutes)	190
Laundry Type	Very dirty cotton and textiles including underwear, linen, tablecloths, towels (max 4kg) and bedclothes.

2. Cotton Eco

Washing Temperature (°C)	60°e , 60° , 40°e , 40°, 30°, --
Maximum Dry Load (kg)	8
Detergent Compartment	II
Programme Duration (minutes)	200
Laundry Type	Dirty cotton and textiles including underwear, linen, tablecloths, towels (max 4kg) and bedclothes.

60°e and **40°e** represent energy label declaration programme.

3. ECO 20°

Washing Temperature (°C)	20° , --
Maximum Dry Load (kg)	4
Detergent Compartment	II
Programme Duration (minutes)	103
Laundry Type	Less dirty cotton and linen textiles including underwear bedsheets, tablecloths and towels (max 2kg).

4. Synthetics (Sub-programme - see page 29)

Washing Temperature (°C)	40° , 30°, --
Maximum Dry Load (kg)	3.5
Detergent Compartment	II
Programme Duration (minutes)	88
Laundry Type	Very dirty or synthetic-mixed textiles such as nylon socks, shirts and blouses.

4. Curtains (Sub-programme - see page 29)

Washing Temperature (°C)	40° , 30°, --
Maximum Dry Load (kg)	2.5
Detergent Compartment	I & II
Programme Duration (minutes)	131
Laundry Type	Curtains only.

USAGE >

5. Wool (Sub-programme - see page 29)

Washing Temperature (°C)	30° , --
Maximum Dry Load (kg)	2.5
Detergent Compartment	II
Programme Duration (minutes)	53
Laundry Type	Woollen laundry with a machine wash label.

5. Silk (Sub-programme - see page 29)

Washing Temperature (°C)	30° , --
Maximum Dry Load (kg)	2.5
Detergent Compartment	II
Programme Duration (minutes)	102
Laundry Type	Sensitive laundry or laundry recommended for handwash.

6. Duvet

Washing Temperature (°C)	40° , 30°, --
Maximum Dry Load (kg)	2.5
Detergent Compartment	II
Programme Duration (minutes)	98
Laundry Type	Fibre quilts with a machine washable label.

7. Extras: Rinse (Sub-programme - see page 29)

Washing Temperature (°C)	--
Maximum Dry Load (kg)	8
Detergent Compartment	II
Programme Duration (minutes)	47
Laundry Type	Provides an additional rinse to any type of laundry after the washing cycle.

7. Extras: Spin (Sub-programme - see page 29)

Washing Temperature (°C)	--
Maximum Dry Load (kg)	8
Detergent Compartment	-
Programme Duration (minutes)	17
Laundry Type	Provides an additional spin cycle to any type of laundry after the washing cycle.

7. Extras: Drain (Sub-programme - see page 29)

Washing Temperature (°C)	-
Maximum Dry Load (kg)	8
Detergent Compartment	-
Programme Duration (minutes)	3
Laundry Type	Drains the Washing Machine.

7. Extras: Drum Clean (Sub-programme - see page 29)

Washing Temperature (°C)	-
Maximum Dry Load (kg)	-
Detergent Compartment	-
Programme Duration (minutes)	90
Laundry Type	Clean the Washing Machine drum. Do not use this programme with laundry in the machine.

8. Sensitive

Washing Temperature (°C)	60°, 50°, 40°, 30°, --
Maximum Dry Load (kg)	8
Detergent Compartment	II
Programme Duration (minutes)	218
Laundry Type	Baby clothes with a machine washable label.

9. Rapid 12 min

Washing Temperature (°C)	30°, --
Maximum Dry Load (kg)	2
Detergent Compartment	II
Programme Duration (minutes)	12
Laundry Type	Dirty cotton, coloureds and textiles.

Programme 10: Due to the short washing time of this programme, we recommend that less detergent is used than with other programmes. The programme may last longer than 12 minutes if your Washing Machine detects an uneven load.

10. Daily 60° 60'

Washing Temperature (°C)	60°, 50°, 40°, 30°, --
Maximum Dry Load (kg)	4
Detergent Compartment	II
Programme Duration (minutes)	60 / 30
Laundry Type	Washes dirty cotton, coloureds and textiles at 60° in 60 mins.

Programme 10: Laundry can be washed in 30 minutes by selecting the Little Dirt setting (see page 43).

USAGE >

11. Sports Wear

Washing Temperature (°C)	30° , --
Maximum Dry Load (kg)	3.5
Detergent Compartment	II
Programme Duration (minutes)	83
Laundry Type	Sportswear.

12. Blouses/Shirts

Washing Temperature (°C)	60° , 50°, 40°, 30°, --
Maximum Dry Load (kg)	4
Detergent Compartment	II
Programme Duration (minutes)	120
Laundry Type	Dirty cotton, synthetic and synthetic mix shirts and blouses.

13. Night Wash

Washing Temperature (°C)	90° , 80°, 70°, 60°, 50°, 40°, 30°, --
Maximum Dry Load (kg)	8
Detergent Compartment	II
Programme Duration (minutes)	182
Laundry Type	Very dirty cotton and textiles including underwear, linen, tablecloths, towels (max 4kg) and bedclothes.

Programme 13: Washes laundry silently and can hold water in the drum for up to 10 hours, or until you press the Start/Standby button. After 10 hours your Washing Machine will automatically discharge water and perform any wringing operations.

Memory I and II Programmes:

Your Washing Machine features two memory programmes. These are used to save programme settings (programme, spin speed, delay, temperature, etc.) that you use regularly.

When you first operate your Washing Machine, these programmes are empty. To save your programme settings into one of the memory slots:

- » Select the settings as normal
- » Press the Memory button
- » Press the button under the desired Memory slot (Memory 1 or Memory 2)

You can now select the stored programme in the same way as any other programme.

It can often be difficult to know which temperature setting is best. To help with this, we have provided a table with common temperatures and their typical uses.

Temperature	Typical Use
30°C	This is the lowest wash temperature that we recommend. By using a detergent that can work at this temperature, you'll save on water and electricity bills.
40°C	This is the most common wash temperature, suitable for most everyday items.
50°C	This is suitable for most polyester/cotton mixtures and nylon.
60°C	This higher temperature is recommended for heavily soiled garments such as baby clothes or bed linen and towels.
90°C	This is the hottest temperature available on your Washing Machine and is suitable for white cottons and linen that show dirt.

Please be aware that the programme setting provides the default temperature for the selected programme. You can override this setting by decreasing the temperature should you wish.

Spin Selection:

You can select a Spin Speed to meet the needs of your wash. The table below suggests some typical selection speeds for common types of clothing. Your Washing Machine will automatically override a Spin Speed if it is not suitable for the selected programme.



Laundry	rpm
Cottons	1400
Delicate	600
Woollens	600
Shirts	600
Denim	800
Dark Garments	1400

You will be pleased to learn that your Servis Washing Machine has an in-built sensor that prevents your Washing Machine operating with an out-of-balance load; it will make several attempts to balance the load prior to the spin cycle. If it is not possible for your Washing Machine to balance the load, your Washing Machine will abort the spin cycle. To reduce the likelihood of this happening, we recommend that you avoid small wash loads containing items that could become heavy through water absorption.

Additional Functions:

To allow you to get the best washing results possible, your Washing Machine offers the following additional functions to complement the selected programme.

You can select an additional function before starting a programme:









- » Press the button on the Control Panel below the symbol of the additional function you wish to select.
- » If the symbol of the additional function flashes continuously, the function has been activated.
- » If the symbol of the additional function blinks, the additional function has not been selected. This may be because the function is not compatible with the selected programme, or the Washing Machine has progressed too far into the programme for selection to be possible.
- » **Easy Ironing** - Select this function by pressing the Easy Iron button when the  symbol is displayed. This enables your laundry to be less wrinkled when the wash is completed.
- » **Stain Level** - This allows you to alter the factory settings on some programmes to suit the dirtiness of your laundry. Press the  button to select one of the following options:
 1. Little dirt (no pre-washing)
 2. Dirty (apply pre-washing)
 3. Very dirty (apply pre-washing)

The table below provides information on the selectable soil level functions for each programme:

Programmes	Stain Level: Selectable or Non-Selectable	Factory Preset	Selectable Levels		Stain Removal*
Cotton	Selectable	Dirty	Very Dirty	Little Dirt	Yes
Cotton Eco	Selectable	Dirty	Very Dirty	Little Dirt	Yes
Eco 20°	Non-Selectable	Little Dirt	Non-Selectable		No
Synthetics	Selectable	Dirty	Very Dirty	Little Dirt	Yes
Curtains	Selectable	Dirty	Very Dirty	Little Dirt	Yes
Wool	Selectable	Dirty	Very Dirty	Little Dirt	No
Silk	Selectable	Dirty	Very Dirty	Little Dirt	No
Duvet	Selectable	Dirty	Very Dirty	Little Dirt	No
Extras **			Non-Selectable		No
Sensitive	Selectable	Dirty	Non-Selectable		Yes
Rapid 12'	Non-Selectable	Little Dirt	Non-Selectable		No
Daily 60° 60'	Selectable	Dirty	Little Dirt	Non-Selectable	Yes
Sportswear	Selectable	Dirty	Very Dirty	Little Dirt	Yes
Blouses/shirts	Selectable	Dirty	Very Dirty	Little Dirt	Yes
Night Wash	Selectable	Dirty	Very Dirty	Little Dirt	Yes

* See page 30.

** Rinse, Spin, Drain and Drum Clean

- » **Prewash** - You can add this additional wash cycle for extra dirty laundry by using this function. When using this function put detergent in the front compartment of the detergent drawer. Press the  button to activate this function.
Please Note: if the  symbol is not displayed when you try to select this function, the programme selected does not use this feature.
- » **Extra Rinse** - This allows you to add up to 3 additional rinses to your laundry. Press the  button until the required number is shown. For example the  symbol indicates that 1 additional rinse has been selected.
- » **Anti-allergic** - You can add this additional rinse operation to your laundry by using this function. Your Washing Machine will carry out all rinsing steps with hot water. We recommend this setting for laundry worn on delicate skin, baby clothes and underwear. Press the  button until the  symbol is shown on the electronic display.
Please Note: if the  symbol is not displayed when you try to select the anti-allergic function, the programme selected does not use this feature.
- » **Child Lock** - Press and hold the buttons either side of the child lock icon simultaneously for at least 3 seconds to activate the child lock,  will be displayed on the control panel.
To release the child lock, simultaneously press both buttons for a minimum of 3 seconds.  will be displayed on the control panel.

Cancelling a Programme:

To cancel a programme while it is running:

- 1 Turn the programme dial to the top position. The programme will stop.
- 2 Turn the programme dial to any programme. Your Washing Machine will discharge any water left from the cancelled programme.

Programme End:

Your Washing Machine will automatically stop once the selected programme has finished. The digital display will read **Finished**.

Removing Your Laundry:

- 1 Turn the programme selection dial to the Stop position. Your Washing Machine door lock will automatically be released approximately 2 minutes after the programme has finished.
- 2 Pull the door handle forwards and open the door fully.
- 3 Remove your laundry; check that all items have been removed from the drum. Any items left in the drum could discolour items in the next wash or become discoloured themselves.
- 4 Check the drum and door seal for any small articles that may have become dislodged.
- 5 Leave the door open for a short time to allow the interior of your Washing Machine to dry. Check the drum is dry and empty before closing the door.

Power Supply Failure:

If a power cut should occur while a programme is running, the programme will continue from the same point once power is restored. This will not cause any harm to your Washing Machine or laundry.

During a power cut, the door lock mechanism will release after 2 minutes. Do not open the door if there is water in your machine. If you wish to collect your laundry, drain your Washing Machine first. Page 50 contains instructions on how to drain your machine if there is no power.

MAINTENANCE >

GENERAL MAINTENANCE >

From time to time it may be necessary to carry out some routine maintenance of your Washing Machine to ensure that it operates as intended. Before cleaning your Washing Machine:

- 1 Turn your mains power supply off and remove the plug from the socket.
- 2 Turn off the cold water supply.

CAUTION: Do not use solvents, abrasive cleaners, glass cleaners or all-purpose cleaning agents to clean your Washing Machine. They may damage the plastic surfaces and other components with the chemicals they contain.

External Casing:

- » Use a mild, non-abrasive cleaning agent, or soap and water, to clean the external casing. Wipe dry with a soft cloth.

The Drum:

- » Use a suitable stainless steel cleaning agent to clean the drum. Follow the manufacturer's advice on the cleaning agent's packaging.

Extra Cleaning:

- » Deposits may build up in your machine when washing is mainly carried out at low temperatures. To prevent these deposits from building up, carry out a hot wash (70°C or above) once every 6 weeks. If you have no reason to wash occasionally at this high temperature, run a high temperature cottons programme with detergent but no laundry at regular intervals.

Filters:

Water Inlet Filters:

Water inlet filters prevent dirt and foreign materials from entering your machine. It is recommended that these filters are cleaned when your machine is unable to receive sufficient water, although your water supply is on and the tap is open.

To clean the water inlet filters:

- 1 Unscrew the water inlet hose from the Washing Machine by turning the hose anti-clockwise and gently pulling.
- 2 To remove the water inlet filter from the water inlet valve, use a pair of long-nosed pliers to gently pull on the plastic bar in the filter (fig 17).

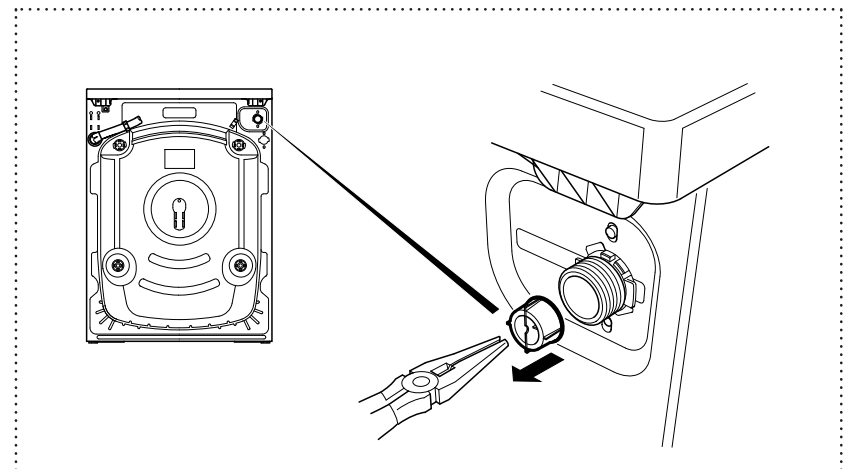

Figure 17

MAINTENANCE >

GENERAL MAINTENANCE >

- 3 Clean the filter thoroughly with a soft brush, wash with soapy water and rinse thoroughly.
- 4 Re-insert the filter by gently pushing it back into place.

A second water inlet filter is located in the tap end of the water inlet hose.

To remove the second water inlet filter:

- 1 Use a pair of long-nosed pliers to gently pull on the plastic bar in the filter.
- 2 Clean the filter thoroughly with a soft brush and wash with soapy water and rinse thoroughly.
- 3 Re-insert the filter by gently pushing it back into place.

Pump Filter:

The pump filter system in your Washing Machine prolongs the life of the pump by preventing lint from entering your machine. We recommend that you clean the pump filter every 2-3 months. The pump filter is located behind the cover on the front-lower right corner.

CAUTION: The water in the pump may be hot, wait for it cool before carrying out any cleaning or maintenance.

Cleaning the Pump Filter:

- 1 Before opening the filter cover, place a container under the filter cover to collect any water left in the machine. Pull the top of the cover forwards using the finger groove, until the pump filter is fully exposed (fig 13a).
- 2 Loosen the filter by turning anti-clockwise and remove by pulling (fig 13b). Wait for the water to drain.

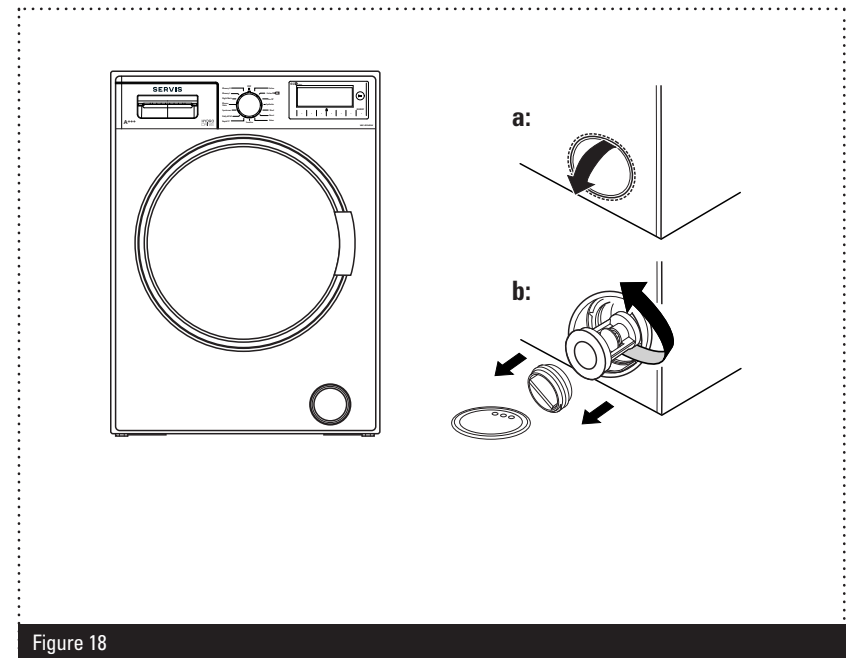

Figure 18

MAINTENANCE >

- 3 Remove any foreign materials from the filter with a soft brush.
- 4 Move the pump by hand to check that it rotates freely.
- 5 Clean the pump with a soft brush.

After Cleaning:

- 1 Re-fit the filter by inserting it and turning clockwise.
- 2 Close the filter cover.

DETERGENT DRAWER >

The use of detergent may cause residual build up in the detergent drawer over time. Remove the drawer at regular intervals to clean the accumulated residue.

To remove the detergent drawer:

- 1 Pull the drawer forwards until it is fully extended.
- 2 Press down on the siphon lid (fig 19) and pull the drawer from its housing.

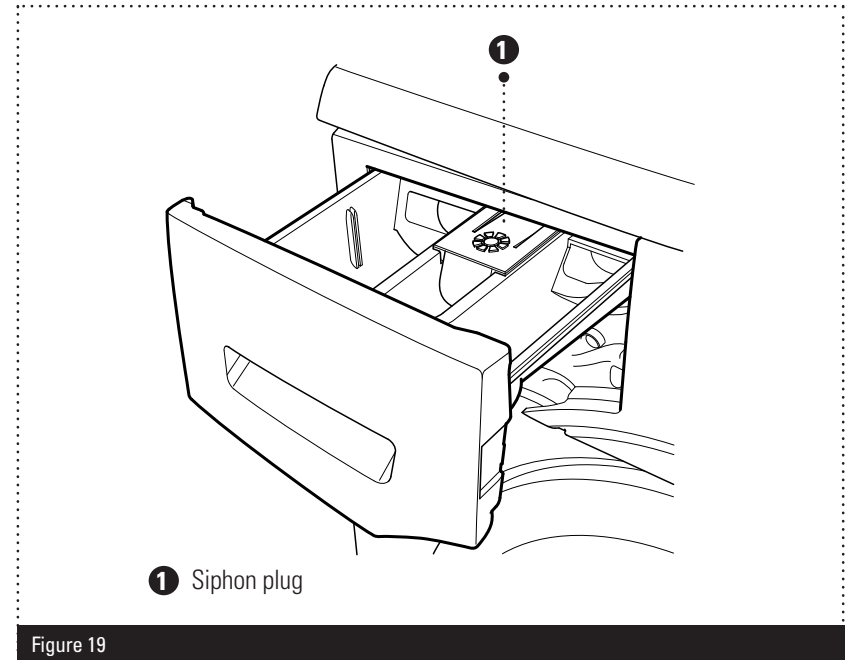

Figure 19

- 3 Clean the drawer with water and a soft brush.
- 4 If there is any residue in the drawer housing, remove with a soft brush. Take care to prevent any residue from dropping into the machine.

To replace the drawer:

- 5 Dry it thoroughly and slide it back into the housing.

CLOTHING CARE >

SIPHON PLUG >

The siphon plug is located in the  compartment of the detergent drawer. Remove the detergent drawer fully and pull the plug upwards.

Clean the plug with a soft brush and replace, checking that it is firmly in position.

GENERAL WASHING INSTRUCTIONS >

When selecting your washing programme take care to note any instructions displayed on the international washing signs in your garments and textiles.



Washing Temperature



Do Not Wash

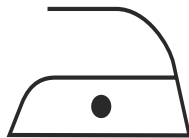

Lukewarm Iron

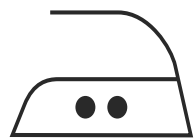

Medium Hot Iron

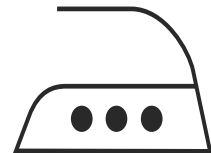

Hot Iron

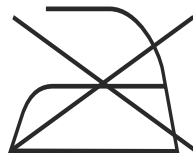

Do Not Iron

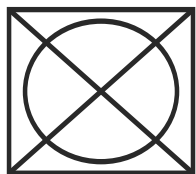

Do Not Tumble Dry

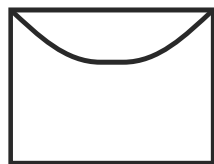

Hang To Dry



Normal Washing



Drip Dry

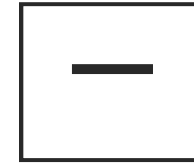

Dry Flat

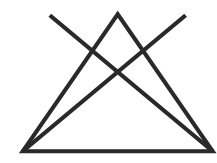

Do Not Bleach



Handy To Bleach



Any Bleach Allowed

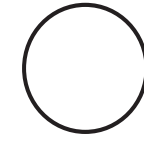

Can Be Dry Cleaned

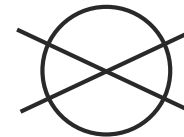

No Dry Cleaning

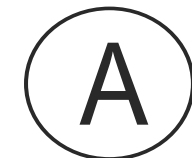

These letters are used to instruct professional cleaners as to which type of solvent to use. Do not wash garments with these symbols in your Washing Machine unless the label says otherwise.

STAIN REMOVAL INFORMATION >

If can often be hard to know the best way to treat a stubborn stain. To help with this we've provided you with a few tips on dealing with the most common types before running your wash cycle.

Alcohol:

For red wine stains, see page 30. For other alcohol stains, wash the stain in cold water, wipe with glycerine and water and rinse with water mixed with vinegar.

Shoe Polish:

Scratch out the stain taking care not to damage the material, rub with detergent and rinse.

Tea and Coffee:

See page 30.

Chocolate and Cocoa:

See page 30.

Tomato Paste:

See page 30.

Egg:

See page 30.

Grease and Oil:

For oil stains, see page 30. For other types of grease stains, rub the stain with detergent and then wash in lukewarm soapy water.

Mustard:

Apply glycerine to the stained area, rub with detergent and hand wash.

Blood:

See page 30.

Cream, Ice Cream and Milk

For ice cream stains, see page 30. For milk or cream stains, soak your clothes in cold water and rub the stained area with detergent.

Mould:

Clean the stained area as soon as possible and hand wash with detergent.

Ink:

Hold the stained area under cold water and wait until the inky water completely runs off. Rub the stain with water and diluted lemon juice, wait 5 minutes before beginning the wash cycle.

Fruit:

See page 30.

Grass:

See page 30.

Oil-Based Paint:

Apply paint thinner to the stained area before it dries, then rub the area with detergent and wash.

TROUBLESHOOTING >

TROUBLESHOOTING INFORMATION >

If your Washing Machine is not operating as expected, you may find a simple solution listed in the table below.

If your Washing Machine is not working and one or more of the indicator lights are flashing, this means that the automatic error detection system has diagnosed a fault. The table on page 60 will provide you with more information.

If your machine has developed a fault not covered in this manual, please contact the Servis helpdesk.

Fault	Possible Cause	Solution
Your Washing Machine does not operate	It is switched off at the mains	Check that your Washing Machine is plugged in and turned on at the mains
	The programme dial is in the stop position	Use the programme dial to select the desired programme
	Start/Pause button not pressed	Press Start/Pause button
	The door is not shut properly	Check that the door 'clicks' shut
Your Washing Machine does not receive water	The cold water supply tap is off	Check that the cold water supply tap is fully turned on
	The water fill hose is bent, twisted, kinked or trapped	Check that there are no bends, twists or kinks and that the fill hose is not trapped





Fault	Possible Cause	Solution
Your Washing Machine does not receive water	The water inlet filters are blocked	Clean the water inlet filters. See page 48 for detailed instructions
Your Washing Machine is not draining water	The drain hose is bent, twisted, kinked or trapped	Check the drain hose and straighten out any kinks, twists or bends
	The pump filter is obstructed	Clean the pump filter. See page 50 for detailed instructions
	Your laundry is too tightly packed together in the drum	Check that your laundry is spread out
Your Washing Machine is vibrating	The feet of your machine are not correctly adjusted	Adjust the feet. See page 11 for further information
	The transit bolts are not removed	Remove the transit bolts. See page 9 for further information
There is excessive foam in the detergent drawer	Too much detergent has been used	Press the Start/Pause button. To stop the foam, dilute one tablespoon of softener into 1/2 litre of water and pour into the detergent drawer. Press the Start/Pause button after 5-10 mins

TROUBLESHOOTING >

Fault	Possible Cause	Solution
There is excessive foam in the detergent drawer	The wrong detergent has been used	Only use detergents produced for automatic Washing Machines
The washing result is not as expected	Your laundry is too dirty for the programme you've selected	Use the information on pages 33 to 40 to select the most appropriate programme
	Not enough detergent used	Use the amount of detergent as instructed on the packaging
	There is too much laundry in your Washing Machine	Check that the maximum capacity of your Washing Machine is not exceeded. See pages 33 to 40 for more information
The water from the machine is drained as soon as it is filled	The end of the water drain hose may be too low	Check that the drain hose is at a suitable height. See page 14 for more information
The spin cycle does not take place	The in-built sensor has prevented your Washing Machine from operating with an out-of-balance load	Avoid small wash loads containing items that could become heavy through water absorption

AUTOMATIC DETECTION SYSTEM >

Your Washing Machine is equipped with a built-in fault detection system which shows any fault details on the electronic display. The most common failure codes are shown below. If your machine displays a code not shown, or if the problem persists after you have taken corrective action, consult the Servis helpdesk.

Error Code	Possible Failure	Solution
	The door is not shut properly	Shut the door properly so that you hear the click
	The pump has failed, or the pump filter is obstructed	Check that the cold water tap is fully turned on
	There is an excessive amount of water in your Washing Machine	Your Washing Machine will automatically drain the water. Turn your Washing Machine off, unplug it and contact the Servis helpdesk
	There is no water supply or the mains water pressure is low	Check mains water supply is on and has sufficient pressure. If the mains supply has been cut off, switch the control dial to Stop and re-select the programme once the supply has been restored.
	Faulty pump or clogged pump filter	The pump filter may be clogged. Check and clean if necessary

GUARANTEE >

DISPOSAL OF YOUR OLD MACHINE >

All packaging and materials used are environmentally friendly and recyclable. Please dispose of any packaging in an environmentally friendly manner. Consult your local council for further details.

To ensure safety when disposing of an old machine, cut off the main power supply cable and break the door hinges or lock.



Please refer to the rear cover for disposal instructions.

GUARANTEE >

The Servis guarantee covers the cost of parts/labour/call out charges to repair an appliance should any covered component fail in its normal functions necessitating a repair or replacement to resume those functions.

The Servis guarantee **does not** cover:

- » Accidental damage
- » Use in a commercial environment
- » Incorrect or faulty installation
- » Deliberate damage or neglect
- » Repairs to cosmetic parts

- » Damage caused by foreign objects or substances
- » Claims in respect to routine inspection or maintenance

The Servis guarantee is not transferable.

For your Servis guarantee to be valid, you will need to retain your original purchase receipt and be able to provide it when you make a claim.

The above summary does not include all of the terms and conditions and exclusions which can be found on our website www.servis.co.uk.

KNOW YOUR RIGHTS >

Household contents insurance

Your household insurance may cover you for accidental damage, fire or theft of your product.

Data Protection Act (1988)

Please note that any information provided will be processed by us or our agents in compliance with the provisions of the Data Protection Act 1988, for the purpose of providing cover and handling claims, if any, which may necessitate providing such information to third parties.

INDEX >

A

Adding detergent	27
Additional functions	43
Adjusting the feet	11
Adjusting the sound	22
Anti-allergic function	45

C

Cancelling a programme	45
Child lock	45
Cleaning	47
Connection, drain hose	13
Connection, electrical	16
Connection, water supply	12
Control panel	17

D

Delay programme start	31
Detergent	27
Detergent drawer	07
Disposal	61
Drain hose connection	13

E

Easy iron	43
Eco time setting	21
Electrical connection	16
Error codes	60
Extra rinse	45

F

Fabric conditioner	29
Factory settings	24
Feet, adjustment	11
Filters	48
First wash	25
Front view	05
Fuse	16

G

Garment care labels	53
Guarantee	61

H

Half load detection system	27
Hydrodrive Technology	01

I

Installation requirements	09
Items included	02

L

Language setting	20
Liquid starch	29
Loading the drum	26

M

Memory I & II Programme Modes	40
-------------------------------------	----

P

Power supply failure	46
Preparing your laundry	25
Prewash	45
Programme end	46
Programme modes	33
Pump filter	49

R

Rear view	06
Re-fitting of transit bolts	10
Removal of transit bolts	09
Removing your laundry	46
Revert to factory settings	24

S

Safety instructions	02
Screen brightness	22
Screen contrast	23
Selecting a programme	29
Setting the time	18
Smart touch buttons	18
Sorting your laundry	26
Sound adjustment	22
Spin selection	42
Spin speed selector	29
Stain removal function	30
Stain removal information	55
Starting a programme	31

T

Technical specification	08
Temperature selection	29
Transit bolt, re-fitting	10
Transit bolt, removal	09
Troubleshooting	57

W

Warranty	01
Water inlet filter	48
Water softener	28
Water supply connection	13

T: 0333 577 7232
E: info@servis.co.uk

 Visit
servis.co.uk

SERVIS
EFFICIENCY BY DESIGN



The symbol on the product or on its packaging indicates that this product may not be treated as household waste. Instead it shall be handed over to the applicable collection point for the recycling of electrical and electronic equipment. By ensuring this product is disposed of correctly, you will help prevent potential negative consequences for the environment and human health, which could otherwise be caused by inappropriate waste handling of this product. For more detailed information about recycling of this product, please contact your local city office, your household waste disposal service or the shop where you purchased the product.

000000000