

**BHI 300 Domino touch
control induction zone
hob**

INSTRUCTION MANUAL



User Manual for your Baumatic

BHI 300

30 cm 2 induction zone domino
hob



NOTE: This User Instruction Manual contains important information, including safety & installation points, which will enable you to get the most out of your appliance. Please keep it in a safe place so that it is easily available for future reference; for you or any person not familiar with the operation of the appliance.

GS 24/01/11

Contents

Environmental note	4
Important safety information	5 – 8
Specifications	9 - 11
Product and aperture dimensions	9
Product specifications	9
Standard accessories	9
Electrical details	10
Ceramic hob surface layout	10
Control panel layout	11
Using the ceramic hob	11 - 22
Before first use	11
Touch controls	11 – 12
Induction cooking	12
Cooking on an induction zone	12 – 13
Power level settings	13 – 14
Turning off the induction zone after cooking	14
Residual heat indicator	15
Locking the hob top	15
Using the timer as a minute minder	15 – 16
Setting the timer to turn one cooking zone off	16 – 17
High temperature protection	17
Detection of foreign objects	17
Automatic safety cut-off	18
Suitable cookware	18 – 19
Cooking tips	19 - 20
Hob guidelines	21 - 22
Cleaning and maintenance	22 - 23
Cleaning the ceramic hob top	22
After each use	22
Cleaning table	22 - 23
Using a ceramic hob scraper	23
Using a specialist ceramic hob cleaner	23
Installation	24 - 28
Positioning	24
Unpacking the appliance	24
Installing the appliance	25 – 27
Electrical connection	27
Replacing the mains supply cable	28
My appliance isn't working correctly	29 – 31
Error codes	29
General troubleshooting	29 - 30
Contact details	32

This appliance is marked according to the European directive 2002/96/EC on Waste electrical and Electronic Equipment (WEEE). By ensuring this product is disposed of correctly, you will help prevent potential negative consequences for the environment and human health, which could otherwise be caused by inappropriate waste handling of this product.

The symbol  on the product, or on the documents accompanying the product, indicates that this appliance may not be treated as household waste. Instead it shall be handed over to the applicable collection point for the recycling of electrical and electronic equipment.

Disposal must be carried out in accordance with local environmental regulations for waste disposal.

For more detailed information about treatment, recovery and recycling of this product, please contact your local city office, your household waste disposal service or the shop where you purchased the product.



- The packaging materials that Baumatic uses are environmentally friendly and can be recycled.
- Please discard all packaging material with due regard for the environment.

Important safety information



Your safety is of the utmost importance to Baumatic. Please make sure that you read this instruction booklet **before** attempting to install or use the appliance. If you are unsure of any of the information contained in this booklet, please contact the Baumatic Customer Care Department.

General Information

- This appliance is designed for domestic household use and for the cooking and frying of domestic foodstuffs.
- **IMPORTANT:** *The adjacent furniture and all materials used in the installation **must** be able to withstand a minimum temperature of 85°C above the ambient temperature of the room it is located in, whilst in use.*
- Certain types of vinyl or laminate kitchen furniture are particularly prone to heat damage or discolouration at temperatures below the guidelines given above.
- Any damage caused by the appliance being installed in contravention of this temperature limit, **will be the liability of the owner.**
- Your new appliance is guaranteed against electrical or mechanical defects, subject to certain exclusions that are noted in Baumatic's Conditions Of Guarantee. The foregoing does not affect your statutory rights.
- The use of this appliance for any other purpose or in any other environment without the express agreement of Baumatic Ltd. will invalidate any warranty or liability claim.
- You should not use this appliance to store items on or as a work surface.
- No modifications to the appliance are permitted by Baumatic Ltd.
- You should not store or place flammable or highly flammable liquids/materials on top of or near the appliance. Items made from aluminium, plastic or plastic film should also be kept away from the appliance, as they may fuse to the surface.
- **Repairs may only be carried out by Baumatic Service Engineers or their authorised service agent.**

Child Safety

- Baumatic strongly recommend that babies and young children are prevented from being near to the appliance and should not be allowed to touch the appliance *at any time*.
- If it is necessary for younger family members to be in the kitchen, please ensure that they are kept under close supervision at all times.
- Older children should only be allowed to utilise the appliance when supervised.

General Safety

- ✓ The appliance should only be installed and connected by a suitably qualified person.
- ✓ Care should be taken to ensure that the units and work surfaces that you build the appliance into, meet with the relevant standards.
- ✓ If you notice any scratches, splits or cracks in the ceramic glass, you should immediately switch off the appliance and disconnect it from your mains supply. Otherwise there is the risk of electric shock occurring.

During use

- ✓ Any film or stickers that are present on the hob surface when it is delivered should be removed before use.
- ✓ Care should be taken when utilising the appliance, otherwise there is a risk of burns being caused.
- You should not allow the electrical connection cables to come into contact with the hob surface when it is hot or any hot cookware.
- If fat and oil overheats, then it can ignite extremely quickly. For this reason, when cooking with fat and oil the appliance should not be left unattended.
- ✓ Make sure that all of the cooking zones are switched off after use.

- **IMPORTANT:** *This ceramic induction hob fully complies with current legislation regarding electro-magnetic interference and is designed not to interfere with other electronic appliances providing these comply with the same legislation.*
- *As the hob generates magnetic fields in its immediate vicinity, pacemakers and active heart implants must be designed to comply with relevant regulations. If in doubt, you should consult the manufacturer of your device or your Doctor. In this respect, Baumatic can only guarantee the conformity of our own product.*
- *If an object made of metal, (e.g. saucepan lid, knife, fork or spoon) is placed on a cooking zone that is switched on, it can get hot.*

Cleaning

- Cleaning of the hob should be carried out on a regular basis.
- **IMPORTANT:** *Before attempting to clean the appliance, it should be disconnected from the mains and allowed to cool.*
- Great care should be taken whilst using this appliance and when following the cleaning procedure.
- You should not use a steam jet or any other high pressure cleaning equipment to clean the appliance.

Installation



This appliance must be correctly installed by a suitably qualified person, strictly in accordance with the manufacturer's instructions. Please see the specific section of this booklet that refers to installation.

Baumatic Ltd. declines any responsibility for injury or damage, to person or property, as a result of improper use or incorrect installation of this appliance.

Declaration of conformity

This appliance complies with the following European Directives:

- 73/23/EEC dated 19/02/1973 Low Voltage Directive.
- 89/336/EEC dated 03/05/1989 EMC Directive inclusive of Amending Directive 92/31/EEC.
- 93/68/EEC dated 22/07/1993 CE Marking Directive.
- 89/109/EEC dated 25/01/1992 Materials that can touch food.

- The manufacturer declares that the hob is built using certified materials and requires the appliance to be installed in accordance with the standards currently in force. This appliance must be used by a trained person for domestic purposes only.

To avoid damaging your appliance

- The ceramic glass can be damaged by objects falling onto it.
- The ceramic glass edge can be damaged by knocks from cookware.
- Cast iron and cast aluminium cookware with damaged bases may scratch the ceramic surface if they are dragged across it.
- Pans should be lifted on and off the hob surface and not dragged.
- Cooking zones should not be switched on without cookware placed on it. Also the cookware should not be empty.
- Food or liquid that has high sugar content may damage the hob top, if it comes into contact with the ceramic hob surface. Any spillages should be wiped up immediately, however this may not prevent the hob surface from becoming damaged.

Specifications

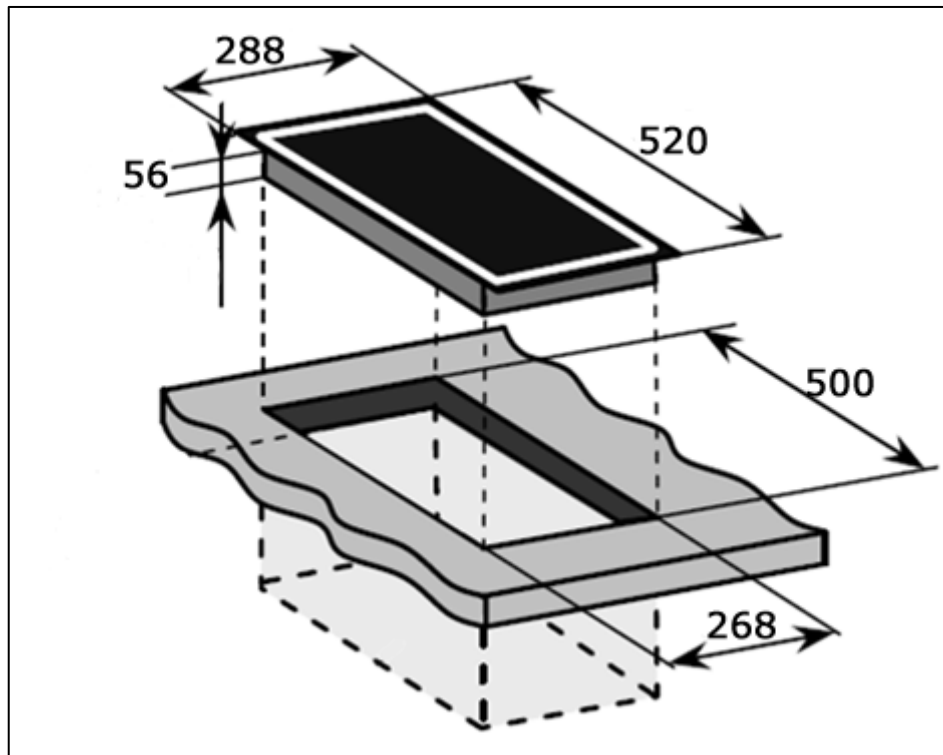

Product dimensions

Depth: 520 mm
Width: 288 mm
Height: 56 mm

Aperture dimensions

Depth: 500 mm
Width: 268 mm

Product specifications:

- 1 x 2.00 kW induction zone
- 1 x 1.50 kW induction zone
- Front touch control operation
- Automatic safety cut-off
- Residual heat indicator
- Timer
- Safety lock

Standard accessories

- Ceramic hob scraper

Electrical details

Rated Voltage:	220 - 240 Vac 50 Hz
Supply Connection:	20 A (double pole switched fused outlet with 3mm contact gap)
Max Rated Inputs:	3.50 kW
Mains Supply Lead:	3 core x 1.5 mm ²

For future reference please record the following information which can be found on the rating plate and the date of purchase which can be found on your sales invoice. The rating plate of your hob is located on the underneath of the appliance. Therefore it is a good idea to record this information before you install your appliance.

Model Number

Serial Number

Date of Purchase

Ceramic hob surface layout

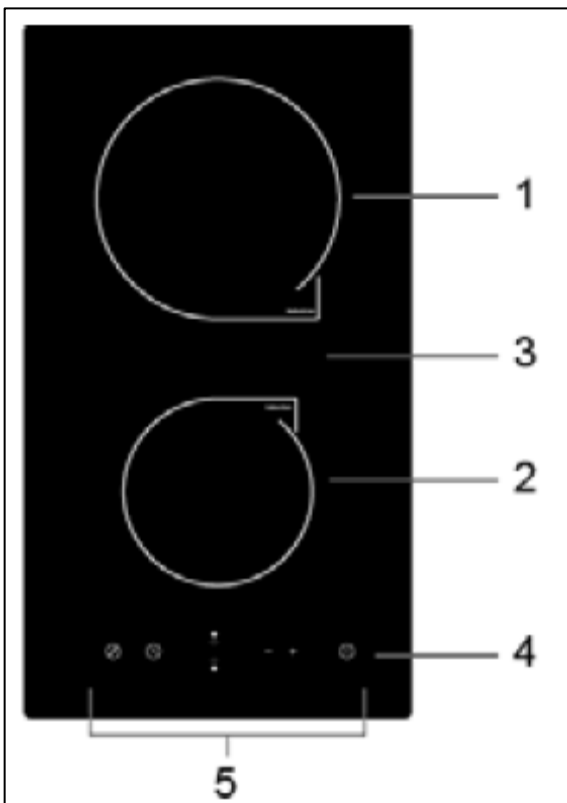

- 1) 1 x 2.00 kW induction zone
- 2) 1 x 1.50 kW induction zone
- 3) Ceramic hob surface
- 4) ON / OFF button
- 5) Control panel

Control panel layout

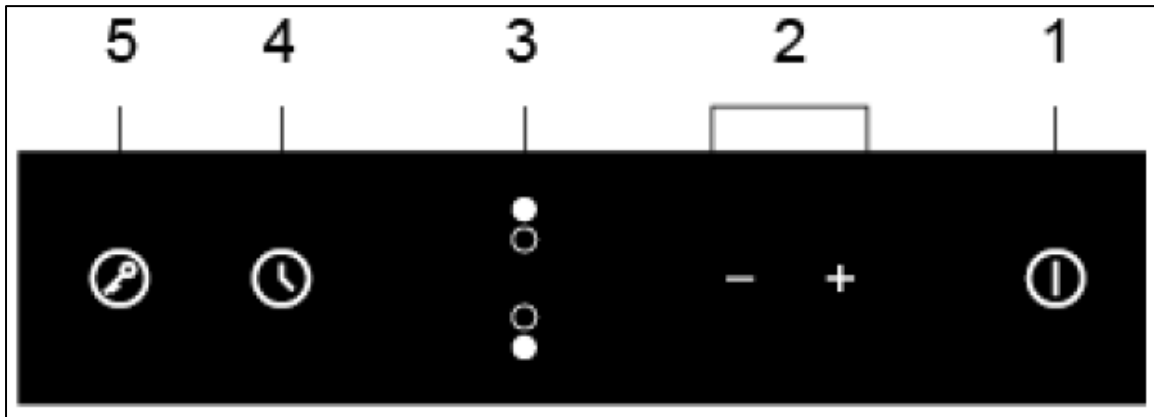

1. ON/OFF button
2. Power / timer plus and minus buttons
3. Heating zone selection buttons
4. Timer button
5. Safety lock button

Using the ceramic hob

Before first use



IMPORTANT: You should clean the ceramic hob surface (see "Cleaning and maintenance" section).

- You should switch on one cooking zone at a time, for 5 minutes at the maximum setting. This will help to eliminate any new smell that exists and evaporate any humidity that has formed on the heating elements during transit.
- Do not burn off more than one zone at once.
- **You must** place a saucepan filled half full with cold water on each zone as you burn it off. Otherwise the induction zone will not operate.

Touch controls

- All operations are performed by means of the touch controls that can be found on the control panel. The controls respond to touch so you don't need to apply any pressure.
- A beep will sound each time a touch is registered.
- Take care to ensure the controls are always clean and dry and that there are no objects such as utensils and cloths covering

them. Even a thin film of water can make the control difficult to operate.

- Use the ball of your finger to press a control, not the tip.

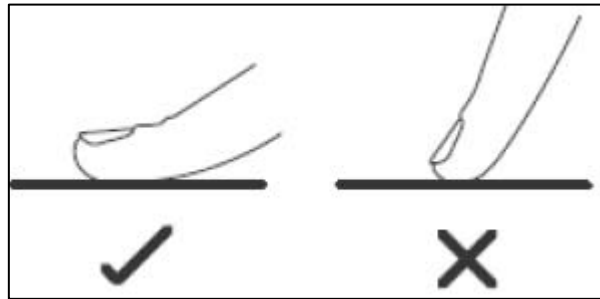

Induction cooking

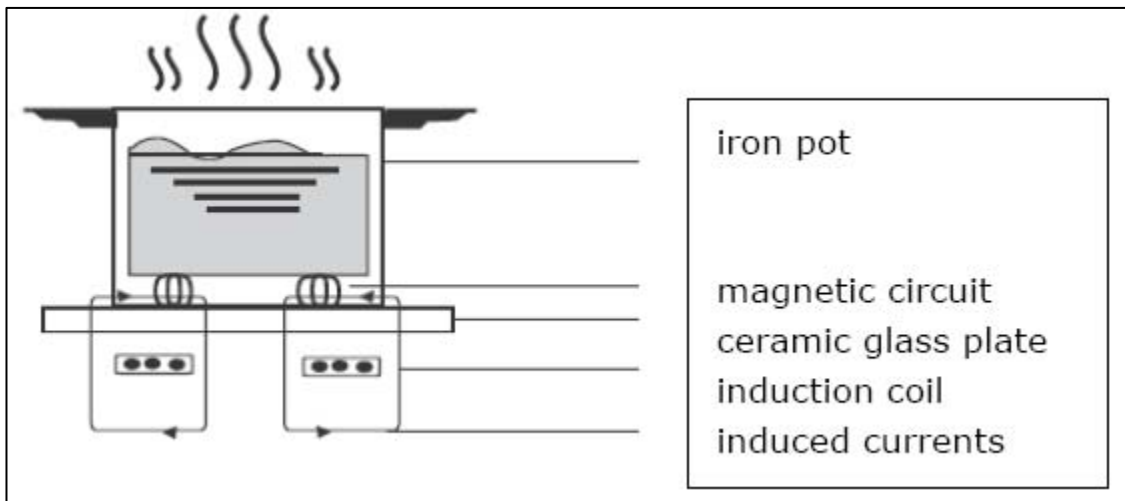

- Induction cooking is a safe, advanced, efficient and economical cooking technology.
- It works by electromagnetic vibrations generating heat directly in the pan, rather than indirectly through heating the glass surface. The only heat present on the glass surface is from the pan which warms it up.

Cooking on an induction zone



- Press the ON/OFF button **(1)**. A buzzer will beep once and all the displays will show - - indicating that the induction hob has entered stand-by mode.

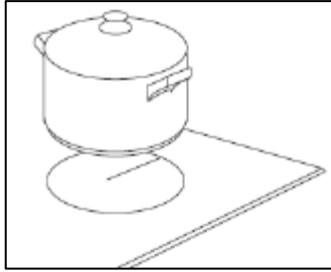

- Place a suitable pan on the cooking zone that you wish to use. Make sure that the bottom of the pan and the surface of the cooking zone are clean and dry.

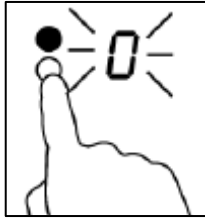

- Press the relevant heating zone selection button **(3)** and an indicator next to the key will flash.

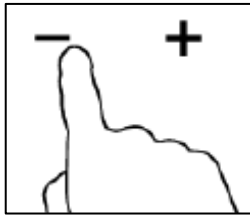

- Select a power level using the plus and minus buttons **(2)**.
- If you don't choose a heat setting within 1 minute, the induction hob will automatically switch off and you

will need to start again.

- You can adjust the heat setting at any time during the cooking process.

IMPORTANT: If the display flashes  alternatively with the heat setting this means that:

- The pan is not placed on the correct cooking zone
- The pan you are using is not suitable for induction cooking. No heating will occur unless there is a suitable pan on the cooking zone.
- The pan is too small or not properly centred on the cooking zone. The display will automatically turn off after 2 minutes if no suitable pan is placed on it.

Power level settings

- The settings on the next page are to be used as a guideline only. The exact setting required will depend on several factors, including your cookware and the amount of food that you are cooking.
- You should experiment with the induction hob power levels to find the best settings to suit you.

Power setting	Suggested use
1 – 2	<ul style="list-style-type: none"> ○ Delicate warming for small amounts of food. ○ Melting chocolate, butter and foods that burn quickly. ○ Gentle simmering. ○ Slow warming.
3 – 4	<ul style="list-style-type: none"> ○ Reheating. ○ Rapid simmering. ○ Cooking rice.
5 – 6	<ul style="list-style-type: none"> ○ Pancakes.
7 – 8	<ul style="list-style-type: none"> ○ Sautéing. ○ Cooking pasta.
9	<ul style="list-style-type: none"> ○ Stir-frying. ○ Searing. ○ Bringing soup to the boil. ○ Boiling water.

Turning off the induction zone after cooking

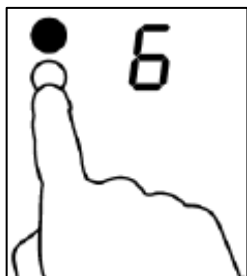

- Press the relevant heating zone selection button for the zone that you wish to turn off.

- Turn the cooking zone off by setting the power level to 0 using the plus and minus buttons **(2)** or by pressing both of these buttons together. You should ensure that the display shows 0.

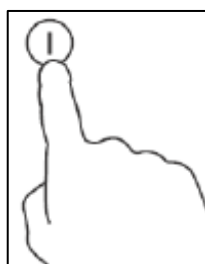
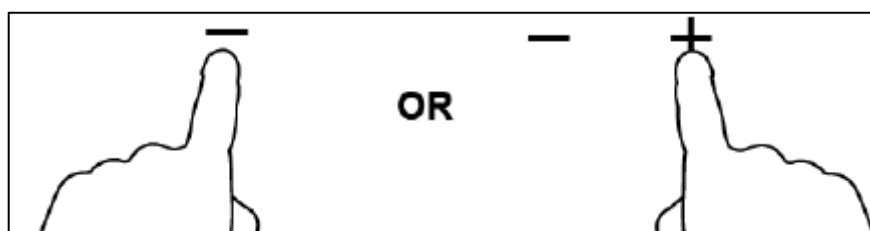

- Switch the whole hob off by pressing the ON/OFF button **(1)**.

Residual heat indicator

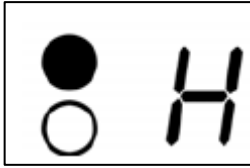

- After a zone is switched off, the display will show the letter "H". This means that the temperature of the indicated zone is still high enough to cause injury.
- When the temperature falls to a safe temperature, then the letter "H" will go out.
- The residual heat can also be used to continue heating pans on the cooking zone that is still hot to save energy.
- **IMPORTANT:** *The residual heat indicator will disappear if your mains supply is cut.*

Locking the hob top

- You can lock the control panel to prevent unintended use by other persons such as children.
- When the safety lock is turned on, all the buttons except the ON/OFF button **(1)** will be disabled.
- To turn the safety lock on, press the safety lock button **(5)**. The timer display will show "Lo" to indicate that the lock has been activated.
- To unlock the controls you need to ensure that the hob is turned on. Then, press and hold the safety lock button **(5)** for a few seconds. The safety lock will then be deactivated.

Using the timer as a minute minder

It is possible to use the minute minder even if you do not turn on a cooking zone.

- Turn the hob on by pressing the ON/OFF button **(1)**.

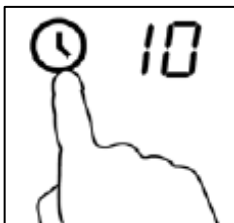

- Press the timer button **(4)** and the minute minder indicator will start flashing. "10" will show in the timer display.

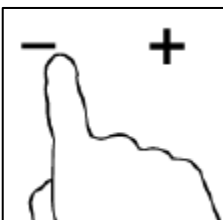

- Set the required countdown time using the plus and minus buttons **(2)**. The maximum time that can be set is 99 minutes.

- Press the plus or minus button once to increase or decrease by 1 minute. Hold the plus or minus button down to increase or decrease by 10 minutes.
- If the setting time exceeds 99 minutes, the timer display will automatically return to 00 minutes.
- If you press the plus and minus buttons **(2)** together, the timer is cancelled and the display will show 00.

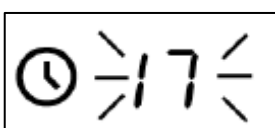

- When the required time is set, the countdown will begin immediately. The display will show the remaining time and the indicator will flash for 5 seconds.

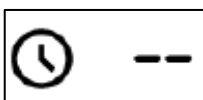

- When the set countdown time is reached, the buzzer will sound for 30 seconds and the timer indicator will show - -.

Setting the timer to turn one cooking zone off

You are able to link the timer to a cooking zone so after the countdown time is complete, the cooking zone will turn off automatically.

- Turn the hob on by pressing the ON/OFF button **(1)**.

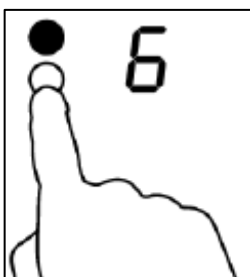

- Press the relevant heating zone selection button **(3)** for the zone that you wish to set the timer for.

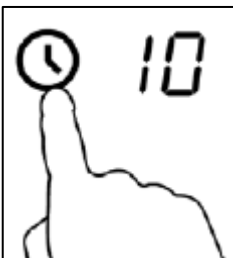

- Touch the timer button **(4)** and the minute minder indicator will start flashing. "10" will show in the timer display.

- Set the required countdown time using the plus and minus buttons **(2)**. The maximum time that can be set is 99 minutes.

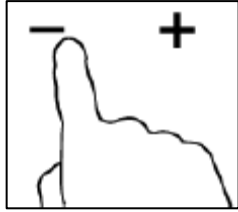

- By pressing the plus or minus button once, the time will increase or decrease by 1 minute. Hold the plus or minus button down to increase or decrease the time by 10 minutes.

- If the set time exceeds 99 minutes, the display will automatically return to 00 minutes.
- If you press the plus and minus buttons (2) together, the timer will be cancelled and the display will show 00.

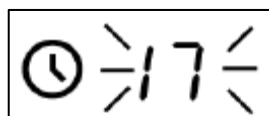

- Once the required time is set, the countdown will begin immediately. The display will show the remaining time and the indicator will flash for 5

seconds.

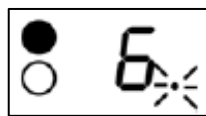

- A red dot next to the power level indicator will illuminate to show the cooking zone that has the linked timer.

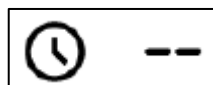

automatically.

- When the countdown time is complete, the corresponding cooking zone will switch off

IMPORTANT: If in use, the other cooking zone will remain on.

High temperature protection

- A temperature sensor in the hob can monitor the temperature inside of the hob. When an excessively high temperature is detected, the induction hob will turn off automatically.

Detection of foreign objects

- When an unsuitable size or non-magnetic pan, such as aluminium, or another small item, such as a knife, fork or key, has been left on the hob, the hob will automatically go into stand-by mode for 1 minute.
- The hob will continue cooling down for a further minute if the temperature of the hob is high.

Automatic safety cut-off

- The automatic safety cut-off is activated when a cooking zone has been left on longer than the maximum default working time. This is a safety function in the event of the hob being left on accidentally.
- The default working times for the various power levels are shown in the table below.

Power level	1	2	3	4	5	6	7	8	9
Default working time (hours)	8	8	8	4	4	4	2	2	2

- If the pot has been removed from the cooking zone, the induction hob will stop heating immediately and the hob will automatically switch off after 2 minutes.

Suitable cookware

- You should only use cookware with a base that is suitable for induction cooking. Look for the induction symbol on the packaging or on the bottom of the pan.

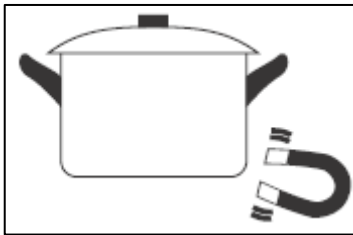

- You can check whether your cookware is suitable by carrying out a magnet test. Move a magnet towards the base of the pan. If it is attracted, the pan is suitable for induction.

- If you do not have a magnet, you can fill the pan with water and place it on a cooking zone. If  does not flash in the display and the water is heating, the pan is suitable.
- Cookware made from pure stainless steel, aluminium or copper without a magnetic base, glass, wood, porcelain, ceramic and earthenware are not suitable.
- Do not use cookware with jagged edges or a curved base.
- Make sure that the base of your pan is smooth, sits flat against the glass and is the same size as the cooking zone.



- Use pans with a diameter as large as the zone selected. By using a slightly wider pot, energy will be used at its maximum efficiency. If you use a smaller pot, the efficiency of the hob could be less than expected.
- Pots that are less than 140 mm in diameter could be undetected by the hob. Always centre your pan on the cooking zone.

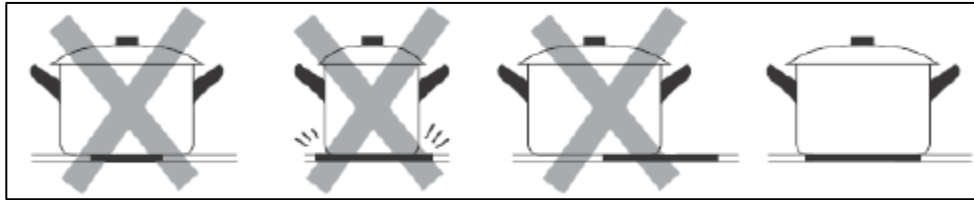

- Always lift pans off the induction hob, do not slide them as they may scratch the glass.

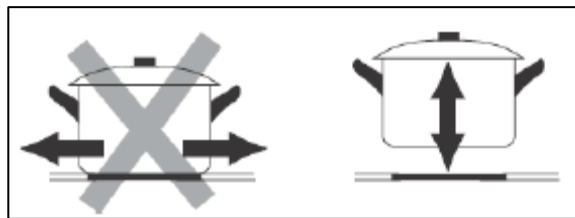

Cooking tips

- ***IMPORTANT: Take care when frying as the oil and fat heat up very quickly. At very high temperatures, oil and fat will ignite spontaneously which presents a serious fire risk.***
- When food comes to the boil, reduce the power level setting.
- Using a lid on pans will reduce cooking times and save energy by retaining the heat.
- Minimise the amount of liquid or fat used to reduce cooking times.
- Start cooking on a high power setting and reduce the power level when the food has heated through.

Simmering, cooking rice

- Simmering occurs below boiling point, at around 85°C, when bubbles are just rising occasionally to the surface of the cooking liquid.
- This process is the key to delicious soups and tender stews because the flavours develop without overcooking the food.

- You should also cook egg-based and flour-thickened sauces below boiling point.
- Some tasks, including cooking rice by the absorption method, may require a slightly higher power setting to ensure the food is cooked properly in the recommended time.

Searing steak

- To cook juicy and flavoursome steaks, you should stand the meat at room temperature for about 20 minutes before cooking.
- Heat up a heavy-based frying pan.
- Brush both sides of the steak with oil. Drizzle a small amount of oil into the hot pan and then lower the meat into the hot pan.
- Turn the steak only once during cooking. The exact cooking time will depend on the thickness of the steak and how well cooked you want it. Times may vary from about 2 – 8 minutes per side. Press the steak to gauge how cooked it is. The firmer it feels the more “well done” it will be.
- Leave the steak to rest on a warm plate for a few minutes to allow it to relax and become tender before serving.

Stir-frying

- Choose an induction compatible flat-based wok or a large frying pan.
- Have all the ingredients and equipment ready. Stir-frying should be quick so if you are cooking large quantities, cook the food in several smaller batches.
- Preheat the pan briefly and add two tablespoons of oil.
- Cook any meat first, then put it aside and keep warm.
- Stir-fry the vegetables. When they are hot but still crisp, turn the cooking zone to a lower power setting. Return the meat to the pan and add your sauce.
- Stir the ingredients gently to make sure they are heated through.
- Serve immediately.

Hob guidelines

- The first few times the hob top is used, it may give off an acrid, burning smell. This smell will disappear completely with repeated use.
- The hob surface is fitted with cooking areas of different diameter and power.
- The positions where the heat will radiate from are clearly marked on the hob top. The saucepans must be positioned exactly on these zones for efficient heating to occur. Pans should have the same diameter as the cooking zone that they are being used on.
- You should not use saucepans with rough bottoms, as this can scratch the ceramic surface.
- Before use, make sure that the bottoms of the saucepans are clean and dry.
- When cold, the bottom of the pans should be slightly concave, as they expand when hot and lie flat on the surface of the hob. This will allow the heat to transfer more easily.
- The best thickness for the bottom of the pans is 2 – 3 mm of enamelled steel and 4 – 6 mm for stainless steel with sandwich type bottoms.
- If these rules are not followed, then there will be a great loss of heat and energy. Heat not absorbed by the saucepan, will spread to the hob, frame and surrounding cabinets.
- Preferably cover pans with a lid to permit cooking at a lower heat.
- Always cook vegetables and potatoes, etc. in as little water as possible, to reduce cooking times.
- Food or liquid that has high sugar content may damage the hob top if it comes into contact with the ceramic hob surface. Any spillages should be wiped up immediately, however this may not prevent the hob surface from becoming damaged.
- ***IMPORTANT:*** *The ceramic hob surface is tough; however it is not unbreakable and can be damaged. Especially if pointed or hard objects are allowed to fall on it with some force.*

- **DO NOT USE THE HOB IF THE SURFACE BECOMES BROKEN OR CRACKED. YOU SHOULD CONTACT THE BAUMATIC SERVICE DEPARTMENT IMMEDIATELY.**

Cleaning and maintenance



Cleaning operations must only be carried out when the oven is cool.

The appliance should be disconnected from your mains supply before commencing any cleaning process.

Cleaning the ceramic hob top



Any residues that are left on the hob top surface from cleaning agents *will* damage it. You should remove any residues with water and a little washing up liquid.



Abrasive cleaners or sharp objects will damage the hob surface; you should clean it using water and a little washing up liquid.



Although it is easier to clean some deposits whilst the hob surface is still warm. You should take care not to burn yourself if cleaning the hob surface when it is still warm.

After each use

- Wipe the appliance over with a damp cloth.
- Dry the appliance by rubbing the surface with a clean cloth.

Cleaning table

<i>Type of deposit</i>	<i>Remove immediately?</i>	<i>Remove when the appliance has cooled down?</i>	<i>What should I use to remove the deposit?</i>
Sugar or food/liquid containing sugar	Yes	No	Ceramic hob scraper
Tin foil or plastic	Yes	No	Ceramic hob scraper
Fat splashes	No	Yes	Ceramic hob cleaner
Metallic	No	Yes	Ceramic hob

discolorations			cleaner
Water splashes or water rings	No	Yes	Ceramic hob cleaner

Using a ceramic hob scraper

Your appliance will be provided with a scraper. The following guidelines should also be followed when using the ceramic hob scraper:-

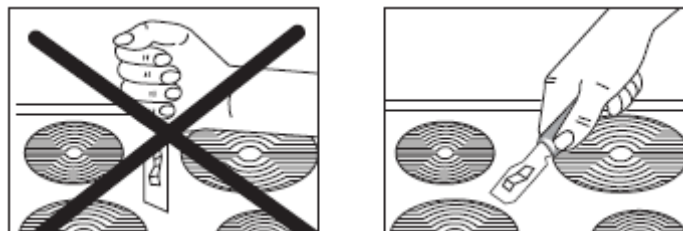

- The scraper should be placed on the ceramic surface at an angle.
- Residues should be removed by sliding the blade carefully over the ceramic surface.
- The ceramic surface should be wiped with a damp cloth that has been dipped in warm, soapy water.
- Dry the appliance by rubbing the surface with a dry clean cloth.

Using a specialist ceramic hob cleaner

It is possible to purchase specialist ceramic hob cleaner/conditioner.

You should follow the instructions given by the manufacturer of the specialist ceramic hob cleaner. You should ensure that it is suitable for use on your appliance.

Installation



The installation must be carried out by a suitably qualified person, in accordance with the current version of the following.

- *UK Regulations and Safety Standards or their European Norm Replacements.*
- *Building Regulations* (issued by the Department of the Environment).
- *Building Standards* (issued by the Scottish Development Department).
- *IEE Wiring Regulations.*
- *Electricity At Work Regulations.*

Positioning



The adjacent furniture must be able to withstand a minimum temperature rise of 85°C above the ambient temperature of the room it is located in, during periods of use.

This appliance is classified as Class 3 and therefore is to be built into a kitchen unit (depending on size) or 600 mm worktop, providing the following minimum distances are allowed:

- 760 mm between the hob surface and the underside of any horizontal surface above it.
- 50 mm clearance around the front, back and sides of the appliance and between the hob surface and any combustible materials, measured from the cut out.

Unpacking the appliance

When unpacking the appliance please check that the following items are contained within the packaging:

- 1 Baumatic hob
- 1 Ceramic hob scraper
- 1 Installation and instruction manual
- 1 Baumatic guarantee card
- 4 Fixing brackets
- 4 Fixing screws

Installing the appliance

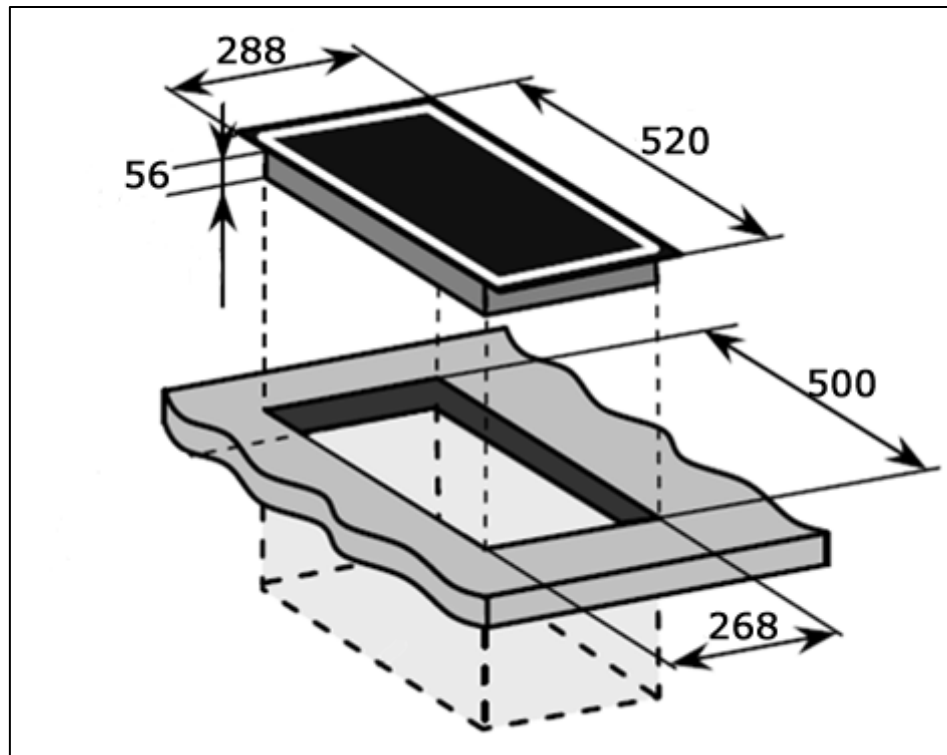

- Cut a hole in the worktop that corresponds with the drawing shown above.

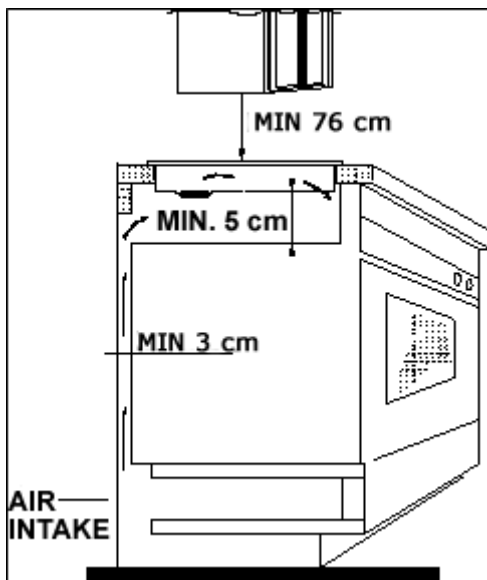

- **IMPORTANT:** You must observe the ventilation requirements shown in the drawing opposite.

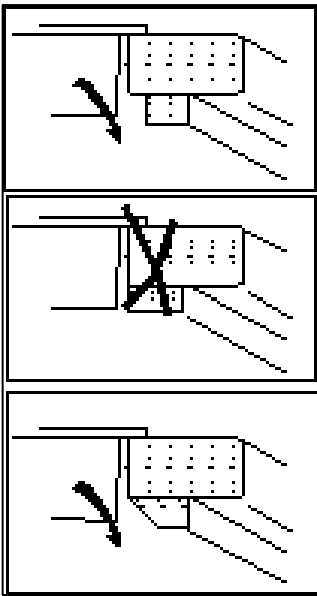

- **IMPORTANT:** There are ventilation holes around the outside of the hob. YOU MUST ensure that these holes are not blocked by the work top, when you put the hob into position (see drawing opposite).
- Carefully turn the hob upside down and place it on a cushioned mat.

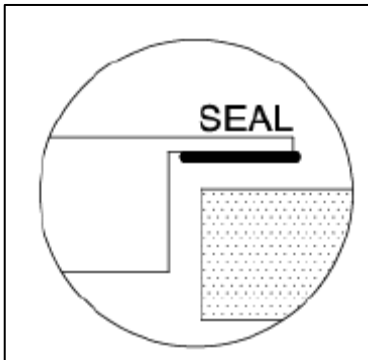

- Apply the sealing strip provided around the edge of the appliance.
- The protective covering must be removed from both sides.
- Do not leave a gap in the sealing agent or overlap the thickness.

- **IMPORTANT:** Do not use a silicon sealant to seal the appliance against the aperture. This will make it difficult to remove the hob from the aperture in future, particularly if it needs to be serviced.
- The supplied brackets need to be fitted to the fixing points on the underside of the hob.
- Place a bracket onto each fixing, ensuring that the outer hole lines up with the hole on the hob.

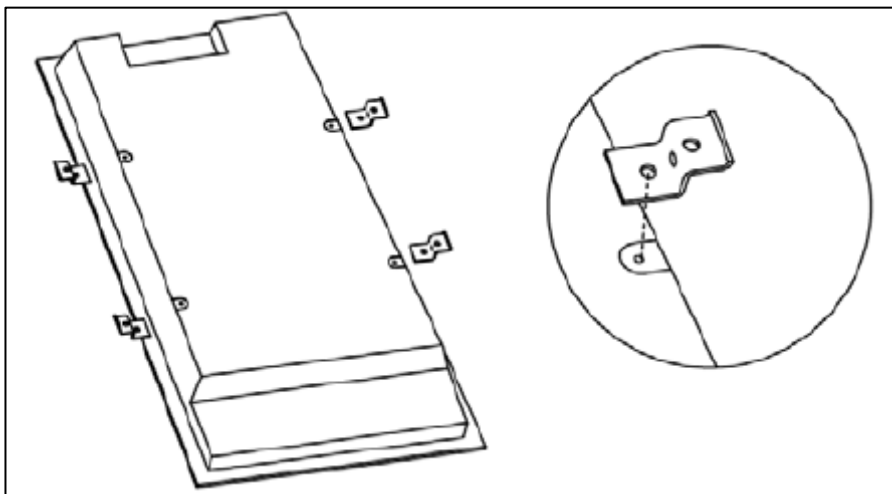

- Fasten the bracket to the position on the hob with a screw. Adjust the bracket position to suit different table top thicknesses.
- Place the long screw into the fixing hole on the outer edge of the bracket but do not fully tighten.
- Carefully turn the hob back over and then gently lower it into the aperture hole that you have cut out.
- When the hob is correctly positioned, tighten the long screws to fix the hob securely in the aperture hole. ***These screws MUST be securely tightened.***

Electrical connection

Before connecting the appliance, make sure that the supply voltage marked on the rating plate corresponds with your mains supply voltage.

WARNING: THIS APPLIANCE MUST BE EARTHED.

- ***This appliance should be wired into a 20 A double pole switched fused spur outlet, having 3 mm contact separation and placed in an easily accessible position adjacent to the appliance. The spur outlet must still be accessible even when your hob is located in its housing.***

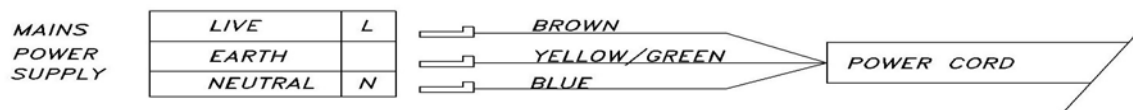

- ***THIS APPLIANCE MUST NOT BE CONNECTED TO A 13 AMP SUPPLY.***
- If you have to change the hob power cord, the earthing (yellow/green) conductor must always be 10 mm longer than the line conductors.
- Care must be taken to ensure that the temperature of the mains supply cable does not exceed 50°C.
- If the mains supply cable is damaged, then it must be replaced by an appropriate replacement.
- Cable type: H05 RRF 3 core x 1.5 mm²

Replacing the mains supply cable

If the mains supply cable is damaged, then it must be replaced by an appropriate replacement.

The mains supply cable should be replaced in accordance with the following instructions:

- **Switch the appliance off at the control switch.**
- Open the terminal block on the underside of the hob.
- Unscrew the terminal screws fixing the cable.
- Replace the cable with one of the same length and specification.
- The “green-yellow” earth wire must be connected to the terminal marked \perp . It must be about 10 mm longer than the live and neutral wires.
- The “blue” neutral wire must be connected to the terminal marked with letter the (N) - the live wire must be connected to the terminal marked with the letter (L).

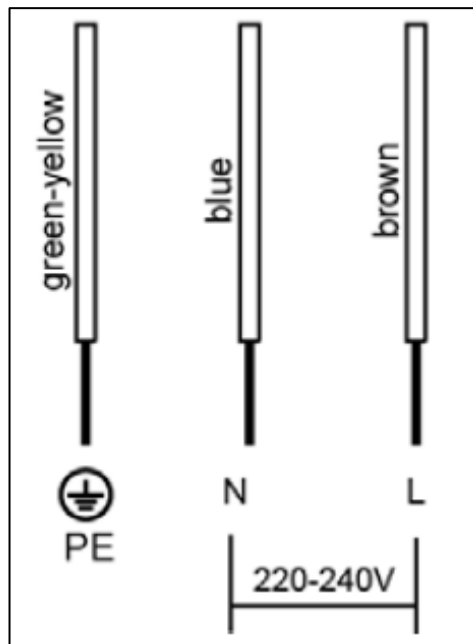

My appliance isn't working correctly

Error codes

If your appliance senses an abnormality, the hob will enter stand-by mode and will display a corresponding error code.

Error code	Possible causes	What to do
F3 - F8	Temperature sensor failure.	Contact the Customer Care Department.
F9 - FE	Temperature sensor of the IGBT failure.	Contact the Customer Care Department.
E1 / E2	Abnormal supply voltage.	Check if the power supply is normal and correct. Restart the hob.
E3 / E4	Abnormal temperature.	Check the pot in use.
E5 / E6	Bad induction hob heat radiation.	Restart after the induction hob has cooled down.

General troubleshooting

If your hob does not appear to be operating correctly, please refer to the table below before contacting the Customer Care Department.

Problem	Possible causes	What to do
The induction hob cannot be turned on.	No power.	Make sure that the induction hob is connected to the power supply and that it is switched on. Check whether there is a power outage in your home or area. If you've checked everything and the problem persists, call the Customer Care Department.
The touch controls are unresponsive.	The controls are locked.	Unlock the controls. See the section on locking the hob top in this manual.
The touch controls are difficult to operate.	There may be a slight film of water over the controls or you may be using the tip of your finger when touching the controls.	Make sure the touch control area is dry and use the ball of your finger when touching the controls.
The glass is being scratched.	Rough-edged cookware. Unsuitable, abrasive scourer or cleaning products being used.	Use cookware with flat and smooth bases. See the section on cookware in this manual.
Some pans make crackling or clicking noises.	This may be caused by the construction of your	This is normal for cookware and does not

	cookware (layer of different metals vibrating differently).	indicate a fault.
The induction hob makes a low humming noise when used on a high heat setting.	This is caused by the technology of induction cooking.	This is normal, but the noise should quieten down or disappear completely when you decrease the power level.
Fan noise coming from the induction hob.	A cooling fan built into your induction hob has come on to prevent the electronics from overheating. It may continue to run even after you've turned the induction hob off.	This is normal and needs no action. Do not switch the power to the induction hob off at the wall while the fan is running.
Pans do not become hot and U appears in the display.	The induction hob cannot detect the pan because it is not suitable for induction cooking. The induction hob cannot detect the pan because it is too small for the cooking zone or not properly centred on it.	Use cookware suitable for induction cooking. See the section on cookware in this manual. Centre the pan and make sure that its base matches the size of the cooking zone.
The induction hob or a cooking zone has turned itself off unexpectedly, a tone sounds and an error code is displayed (typically alternating with one or two digits in the cooking timer display).	Technical fault.	Note down the error letters and numbers, switch the power to the induction hob off at the wall and contact the Customer Care Department.



IMPORTANT: If your appliance appears not to be operating correctly, then you should disconnect it from your mains supply and then contact the Baumatic Service Department on telephone number (0118) 933 6911.

DO NOT ATTEMPT TO REPAIR THE APPLIANCE YOURSELF.

Please note that if an engineer is asked to attend whilst the product is under guarantee and finds that the problem is not the result of an appliance fault, then you may be liable for the cost of the call out charge.

The appliance must be accessible for the engineer to perform any necessary repair. If your appliance is installed in such a way that an engineer is concerned that damage will be caused to the appliance or your kitchen, then he will not complete a repair.

This includes situations where appliances have been tiled in, sealed in with sealant, have wooden obstructions placed in front of the appliance, like plinths. Or any installation other than the one specified by Baumatic Ltd. has been completed.

Please refer to the conditions of guarantee that appear on the warranty card that you receive with the appliance.



United Kingdom

Baumatic Ltd.,
Baumatic Buildings,
6 Bennet Road,
Reading, Berkshire
RG2 0QX
United Kingdom

Sales Telephone

(0118) 933 6900

Sales Fax

(0118) 931 0035

Customer Care Telephone

(0118) 933 6911

Customer Care Fax

(0118) 986 9124

Spares Telephone

(01235) 437244

Advice Line Telephone

(0118) 933 6933

E-mail:

sales@baumatic.co.uk
customercare@baumatic.co.uk
spares@baumatic.co.uk
technical@baumatic.co.uk

Website:

www.baumatic.co.uk

Republic of Ireland

Service Telephone

1-890 812 724

Spares Telephone

091 756 771

Czech Republic

Baumatic CR spol s.r.o.
Průmyslová zóna Sever 696
460 11 Liberec 11
Czech Republic

+420 483 577 200

www.baumatic.cz

Slovakia

Baumatic Slovakia, s.r.o.
Galvániho 7/D
Slovakia

+421 255 640 618

Germany

Baumatic Gmbh
Lilienthalstrasse 1
320 52 Herford
Deutschland

+49 5221 694 99-0

www.baumatic.de

Italy

Baumatic Italia S.R.L.
Via Galvani N.3
35011 Campodarsego (PD)

+3904 9920 2297

www.baumatic.it

Holland

Baumatic Benelux B.V.
Grindzuigerstraat 22
1333 MS ALMERE
Nederland

+3136 549 1555

www.baumatic.nl

