

**BF555SE Under-counter
fridge with 4* freezer
compartment**

INSTRUCTION MANUAL

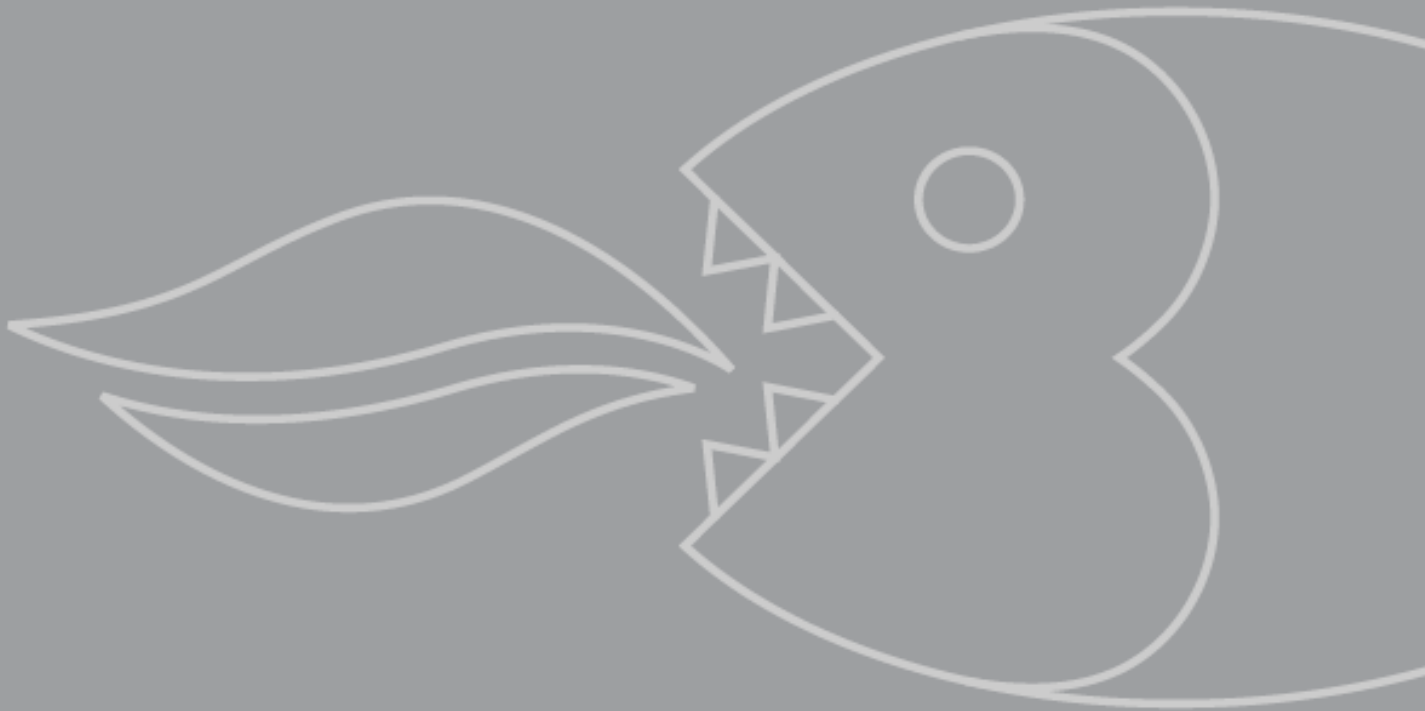

USER MANUAL FOR YOUR BAUMATIC

BF555SE Under-counter fridge with **** freezer compartment



NOTE: This User Instruction Manual contains important information, including safety & installation points, which will enable you to get the most out of your appliance. Please keep it in a safe place so that it is easily available for future reference, for you or any person not familiar with the operation of the appliance.

Contents

Environmental note	4
Important safety information	5 - 7
Specifications of your fridge + **** freezer compartment	7
Description of the appliance	8
Description of the product features	9
Using your Baumatic fridge	10-11
Before switching on	10
During first use	10
Switching on the appliance and setting the thermostat	11
Arranging and storing food in the fridge section	12-13
The **** star freezer compartment	13-14
Normal operating noises	14
Saving energy when using your fridge	15
Cleaning and maintenance	16-19
The defrost drain hole	17
Defrosting the **** freezer compartment	18
Replacing the light bulb	19
Installation	20-24
Electrical connection	20-21
Positioning	21
Levelling the appliance	22
Reversing the door	22-24
Troubleshooting	25-26
Baumatic consumables	27
Technical data	28
Contact details	29

Environmental note

Note: Before discarding an old appliance, switch off and disconnect it from the power supply. Cut off and render any plug useless. Cut the cable off directly behind the appliance to prevent misuse. This should be undertaken by a competent person. Disable the door lock to make sure that children cannot get stuck inside the appliance.

This appliance is marked according to the European directive 2002/96/EC on Waste electrical and Electronic Equipment (WEEE). By ensuring this product is disposed of correctly, you will help prevent potential negative consequences for the environment and human health, which could otherwise be caused by inappropriate waste handling of this product.

The symbol  on the product, or on the documents accompanying the product, indicates that this appliance may not be treated as household waste. Instead it shall be handed over to the applicable collection point for the recycling of electrical and electronic equipment.

Disposal must be carried out in accordance with local environmental regulations for waste disposal.

For more detailed information about treatment, recovery and recycling of this product, please contact your local city office, your household waste disposal service or the shop where you purchased the product.



- The packaging materials that Baumatic uses are environmentally friendly and can be recycled.
- Please discard all packaging material with due regard for the environment.

Important safety information



Your safety is of the utmost importance to Baumatic. Please make sure that you read this instruction booklet **before** attempting to install or use the appliance. If you are unsure of any of the information contained in this booklet, please contact the Baumatic Advice Line.

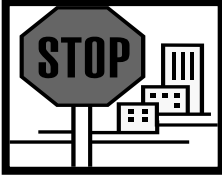

IMPORTANT: Any installation work must be carried out by a qualified electrician or competent person.

Use of the appliance

- Your appliance is only designed to be used in the home. It is suitable for storing food that needs to be chilled and refrigerated or frozen. If it is used for any other purpose or it is not used correctly, then Baumatic Ltd. will accept no liability for any damage that is caused.
- Altering the specification of the appliance must not be attempted for reasons of safety.



Before using your appliance

- Check the appliance for any signs of transport damage. If you notice any damage, then you should not connect your appliance to your mains supply and should contact your retailer.

Refrigerant

- Your appliance contains R600a refrigerant, which is a natural gas that does not contain CFCs that can damage the environment. However it is a flammable substance, therefore care should be taken:
 - During the transportation and installation of the appliance, make sure that the refrigeration pipe work does not get damaged.
 - If it does become damaged then sources of ignition and open flames should be avoided. Also the room that the appliance is situated in should be thoroughly ventilated.

- Do not place any objects on top of the appliance, as this may damage the table top.



Child safety

- Packaging material should be kept away from children.
- Children should not be allowed to touch the controls or play with the appliance.



General safety

- Do not pull on the power supply cable to remove the plug from your mains supply socket.
- Do not pull out or insert the plug with wet hands.
- Do not attempt to use your appliance outdoors or any place where it is likely to come into contact with the elements.
- Before cleaning the appliance or performing maintenance work, ensure that the appliance has been disconnected from your mains supply.
- Never allow the back coils of the appliance to come into contact with the wall surface.
- Always ensure that the location where you are installing your appliance is free of stored items such as papers and other flammable materials.
- Never block the ventilation openings of the appliance, either on the inside or its exterior.
- It is vital to keep your appliance well ventilated, so that there is proper air flow between the bottom of the unit and the plinth/kick plate which it is sitting on.
- Do not place electrical devices inside of the appliance, such as mixers or ice cream makers.

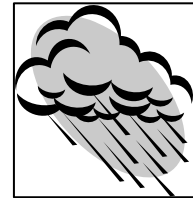

Service

You should not attempt to repair the appliance yourself, as this could cause injury or a more serious malfunction. If you require a service call then please contact the Baumatic Customer Care Department.

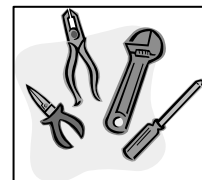

Specifications of your fridge + **** freezer compartment

- Total gross/net capacity: 110/105 litres
- Fridge gross/net capacity: 95/93 litres
- Freezer gross/net capacity: 15/12 litres
- Adjustable thermostat (fridge section only)
- **** star freezer compartment
- Ice cube tray
- Automatic fridge defrost
- 2 x General door racks
- 1 x Bottle rack
- 1 x Adjustable safety glass shelf
- 1 x Salad crisper shelf (safety glass)
- 1 x Salad crisper
- Egg rack
- Adjustable feet
- Reversible door

Dimensions of appliance

Height:	845 mm
Width:	545 mm
Depth:	566 mm

Energy efficiency class

Energy class: A+

IMPORTANT: When you install your appliance it is important to bear in mind its climatic rating.

In order to find out the climatic rating of your appliance, you should check the rating plate. The rating plate is located on the front left edge of the inside of the fridge section. You will need to open the door of your appliance to be able to find it. The rating plate will indicate the ambient temperature range that your appliance will function correctly within.

Description of the appliance

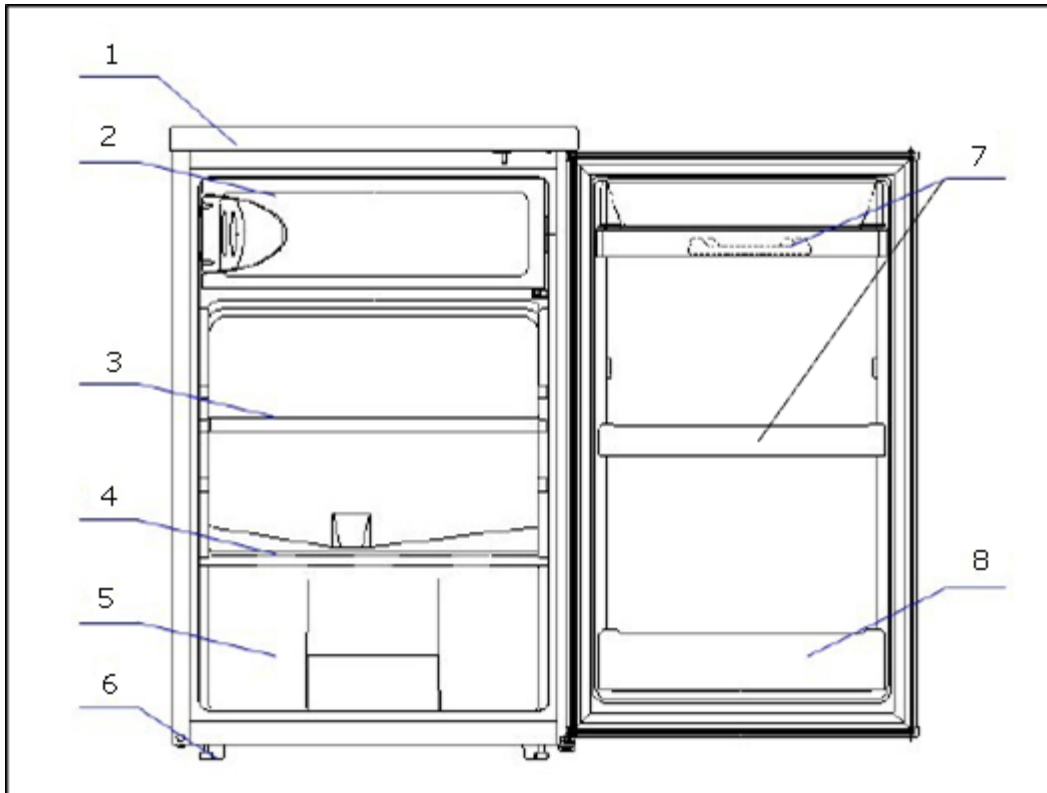

- 1) Top cover
- 2) Freezer compartment
- 3) Adjustable safety glass shelf
- 4) Salad crisper shelf (safety glass)
- 5) Salad crisper
- 6) Adjustable foot
- 7) General door rack
- 8) Bottle rack

Description of the product features

Shelf

- The shelf may be placed in any of the guide slots within the interior of the appliance. They are protected from sliding out.
- To remove a shelf: Take off all of the items that are stored on the shelf. Then lift the front of the shelf and carefully pull it out of the grooves.

Crisper drawer and cover

- The crisper drawer is in the bottom of your refrigerator and there is a cover that goes over it.
- The cover helps to prevent fruit and vegetables from drying out prematurely.

General door racks

- The door liner holds various shelves, which are suitable for storing eggs, cheese, butter and yogurt. As well as smaller packages, tubes, cans etc.

Bottle rack

- The lower door rack should be used for storing reasonably sized bottles.
- ***IMPORTANT: IT IS IMPORTANT THAT NONE OF THE SHELVES THAT SIT IN THE DOOR ARE OVERLOADED, AS THIS WILL DRASTICALLY REDUCE THEIR WORKING LIFE.***

**** freezer compartment

- When you are buying frozen food, look at the storage guidelines on the packaging. You will be able to store each item of frozen food for the period of time shown next to the 4 star rating.

Using your Baumatic fridge

Before switching on

- Make sure that it has been installed by a suitably qualified person, as per the information contained in Baumatic's installation instructions.
- After delivery, wait for a minimum of **eight hours** before connecting the appliance to your mains supply. This will allow any refrigerant gasses that may have been disturbed during the transportation process to settle.
- The outside of the appliance and the removable accessories contained within it, should be cleaned with a solution of liquid detergent and water.
- The interior of the appliance should be cleaned with a solution of sodium bicarbonate dissolved in lukewarm water. The interior and accessories should be thoroughly dried, after the cleaning process has been completed.
- There can be an odour when you first switch on the appliance. It will lessen as the appliance starts to cool.

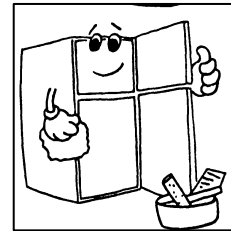

During first use

- With dry hands, connect your appliance to your mains supply. Set the thermostat control knob to position <7> for 24 hours before positioning it to the normal setting of <3>.
- When you first switch on the appliance, the compressor will run more frequently for approximately 24 - 48 hours.
- During this period of time, you should try not to open the door frequently or place a large amount of food within the appliance.
- If the unit is switched off or unplugged, you must allow at least 5 minutes before restarting the appliance on the thermostat or reconnecting it to your mains supply.

Switching on the appliance and setting the thermostat

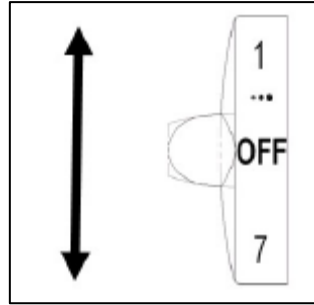

- You switch on your appliance by connecting it to your mains supply and setting the thermostat. The thermostat dial is located on the upper right hand side of the inside of the cabinet, next to the interior light.
- The thermostat automatically regulates the temperature inside the fridge. The temperature is affected by the number that the thermostat dial is set to.
- The OFF position means that the appliance will not cool.
- Position <1> will give you a higher temperature inside the fridge.
- Position <7> will give you a lower temperature inside the fridge.
- Ideally the thermostat dial should be set to position <3>.
- The recommended operating temperature of the fridge is 3°C - 4°C.
- The recommended operating temperature of the freezer is -15°C - -18°C
- **IMPORTANT:** *The ambient temperature of the room, the temperature of food and the amount of food that has been placed in the fridge and how often the door is opened, will all affect the temperature being maintained by the appliance.*
- On the maximum setting (position <7>), your fridge will work harder to maintain a lower temperature and will increase the energy usage. There is no need to run your appliance on setting <7> for prolonged periods.
- **IMPORTANT:** *Do not run the thermostat above position <5> for prolonged periods, otherwise the defrost drainage hole will freeze.*

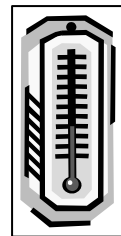

Arranging and storing food in the fridge section

- Warm food or evaporating liquids should not be stored in your refrigerator, as this will increase the humidity inside of the appliance.
- All foods should be wrapped or covered, this is particularly important if the food has a strong flavour. You should use polythene bags or sheets, aluminium foil, wax paper. Liquids should be stored in covered containers or bottles.
- To maximise the space inside of the fridge section, any excessive packaging on the food should be removed.
- Quickly perishable food should be stored at the back of the refrigerator, which is the coldest part of the appliance.
- No food items should be allowed to come into contact with the back wall of the refrigerator.
- Make sure that you arrange food in such a way that the door can close completely. Particular attention should be given to bottles that may protrude when placed on shelves inside the main section of the refrigerator.
- Some organic solutions, such as the oils in lemon/orange peel and acid in butter, can cause damage to the plastic parts contained inside of the refrigerator.
- Do not open the refrigerator door too often or leave the door open for long periods of time, as this will increase the temperature inside of the appliance and will increase the energy usage.
- **Meat** should be wrapped in polythene bags and then placed on the glass shelf above the salad crisper.

(Meat should only be stored in this manner for one or two days at the most).
- **Cold dishes/cooked food** should be covered and can be placed on any shelf.
- **Fruit and vegetables** should be cleaned thoroughly and placed in the salad crisper.
- **Cheese and butter** should be placed in airtight containers, or they can be wrapped in aluminium foil or polythene bags. As much air as possible should be removed from the bags.

- **Milk bottles** should have a cap on them and be stored on the bottle shelf that sits in the door.
- **Garlic, potatoes, onions and bananas should only be stored in a refrigerator IF they are kept in airtight containers.**

The **** star freezer compartment

The freezer compartment is suitable for storing food that is already frozen.

- When you are buying frozen food, look at the storage guidelines on the packaging. You will be able to store each item of frozen food for the period of time shown next to the **** rating. The maximum amount of fresh food that you can store in a 24 hour period is 2 kg.
- Take a quick look at the frozen food packaging and make sure it is in a perfect condition.
- Always buy frozen products last when you are shopping at the supermarket.
- When you are going around the supermarket and when you are travelling home, if you keep all of the frozen foods together they will help to keep each other cold.
- Don't buy frozen food unless you can freeze it straight away. Special insulated bags can be bought from most supermarkets and hardware shops. These keep frozen food cold for longer.
- The guidance of the food manufacturer should be followed, in regard to the maximum storage time.
- Warm food should be allowed to cool down before you attempt to freeze it. If you place warm food in the freezer section, then the increased humidity will cause quicker ice formation and increase the amount of power that the appliance uses.
- Thawed foods must not be frozen for a second time.
- **Do not place bottles (glass or tin) containing liquids (especially sparkling liquids) into the freezer compartment as it could cause them to burst.**
- **IMPORTANT:** You should ensure that the door is always shut properly, otherwise you will get excessive ice and frost build-up inside of the freezer compartment. This will make it necessary to

defrost the compartment more frequently and increase the energy consumption of the appliance.

Normal operating noises

Ice cracking noise

- Can be heard during the automatic defrosting process.
- Can be caused by expansion and contraction within the freezer compartment.

Short cracking noise

- Can be heard when the thermostat turns the compressor on and off.

Compressor noise

- There will be an operating noise when the compressor is running.
- After installation, the compressor may be noisier for a short period of time.

Bubbling and burbling sound

- This noise is emitted as the coolant flows through the pipework within the fridge.

Water flowing sound

- This is caused by water flowing into the evaporating tray during the defrosting process and can be heard whilst the fridge is defrosting.

Saving energy when using your fridge

Installing:

- Install the appliance in a cool position. If it is placed in direct sunlight or next to an oven or other heat source, the energy consumption can increase substantially.
- Ensure the appliance is installed with the correct ventilation requirements. Restricting ventilation can increase the energy consumption by 15%.

Cleaning and Maintenance:

- Occasionally clean the condenser coils (if present) at the back of the appliance to maintain a high performance level.
- Clean the door gasket with warm water or a neutral detergent that leaves no residue. A tight-sealing door gasket is critical to the efficiency of your appliance.

Usage:

- Do not open the door repeatedly or more frequently than you have to.
- Do not set the thermostat too low. A change of just one degree can effect the energy consumption by 5%. Use a thermometer to check the temperature.
- The refrigerator should operate at around 3 to 4 degrees Celsius.
- Allow food to sufficiently cool before putting it in the appliance (but don't let it sit at room temperature for too long).
- If you are going away for a long period of time, turn off the appliance, empty and clean it and leave the door ajar.
- If you have a second appliance that is not used, make sure that it is stored with the power off and the door left ajar until it is actually required.

Disposing:

- If you're going to throw out your old fridge, see if there's a chlorofluorocarbons (CFCs) recycler in your area. The government department which looks after the environment in your area may be able to help you.

Cleaning and maintenance

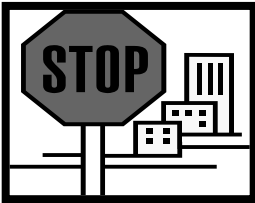

WARNING: PLEASE ENSURE THAT YOUR APPLIANCE IS DISCONNECTED FROM YOUR MAINS SUPPLY BEFORE ATTEMPTING TO CLEAN IT.

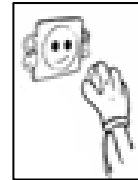

- Do not clean the appliance by pouring water onto it or spraying water over it.



- The refrigerator compartment should be cleaned periodically, using a solution of bicarbonate of soda and lukewarm water.

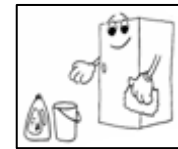

- Clean the accessories separately with soap and water. Do not clean them in a dishwasher.

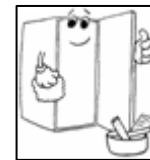

- Do not use abrasive products, detergents or soaps.



- After washing the appliance, wipe over the area that you have cleaned with a damp cloth and then dry it thoroughly.
- When cleaning is complete, dry your hands and then reconnect the plug to your mains supply.

The defrost drain hole

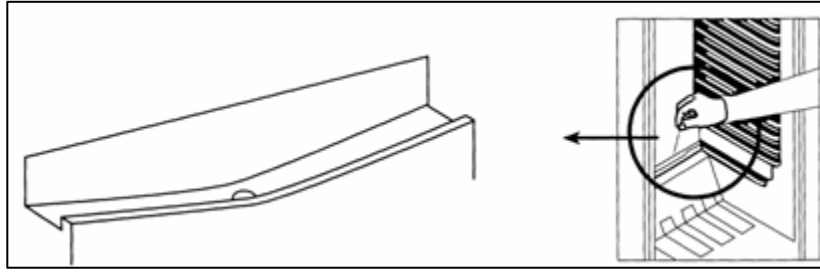

- Defrosting occurs automatically in the refrigerator section during operation. The defrost water is collected by the evaporating tray and evaporates automatically.
- The drain hole should be cleaned periodically with the drain hole cleaner. This will prevent water from collecting in the bottom of the refrigerator, instead of flowing down the defrost drainage channel and drain hole.
- **IMPORTANT:** Please note that the drain hole cleaner should not be left in position permanently. Otherwise this may prevent the defrost water from entering the drain hole.
- You can also pour a small amount of water down the drain hole to clean the defrost drainage channel.
- You should be careful to make sure that food packages do not touch the rear wall of the appliance, as this can interrupt the automatic defrosting process and deflect water into the base of the refrigerator section.
- Use a solution of bicarbonate of soda and lukewarm water to clean the evaporating tray.
- **IMPORTANT:** It is normal to get some ice droplets forming on the back wall of the appliance. The formation of ice droplets does not indicate an appliance fault.

Defrosting the **** freezer compartment

After a period of time frost will build up in the freezer compartment. As a temporary measure, this frost should be scraped away using a plastic scraper. Complete defrosting will however become necessary approximately twice per year, or if the frost layer exceeds 5 cm (2").

This will maintain the efficiency of the refrigerator. It should also be carried out if the frost build up cannot be scraped away, or if it begins to interfere with the storage of ice.

- Turn the refrigerator off at the mains supply and leave the door open.
- Scrape away as much frost build up as possible using a plastic scraper. Thawing of the remaining ice can be speeded up by placing a bowl of hot water inside the freezer compartment and closing the door. As the solid frost loosens, prize it away with the plastic scraper and remove.
- If any defrost water spills into the freezer compartment drain tray, then you should empty this out before switching the appliance back on.
- When defrosting is completed, clean your refrigerator and thoroughly dry it.
- ***DO NOT USE ANY SHARP OBJECTS TO SCRAPE THE FREEZER COMPARTMENT, AS THIS MAY RESULT IN THE LINING BEING PUNCTURED. IF THIS HAPPENS THE APPLIANCE WILL NOT BE REPAIRABLE.***

Replacing the light bulb

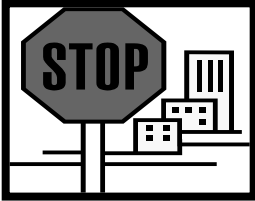

WARNING: PLEASE ENSURE THAT YOUR APPLIANCE IS DISCONNECTED FROM YOUR MAINS SUPPLY BEFORE ATTEMPTING TO REPLACE THE LIGHT BULB.

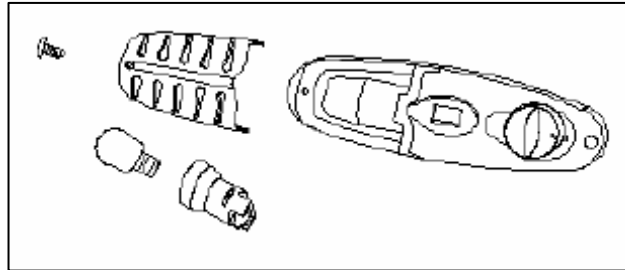
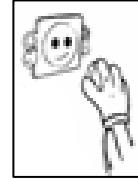

- There is an interior light next to the thermostat dial.
- Using a Phillips head screwdriver, remove the screw at the far end of the light cover and slide the cover off.
- Change the present light bulb with a new one. The replacement bulb should not have a greater rating than 15 W.
- Replace the light cover and after waiting five minutes, reconnect your plug to your mains supply.

Prolonged OFF periods

If the fridge is not in use for a long period of time, you should:

- Disconnect the appliance from the mains supply.
- Clean and dry the inside as instructed on page 16.
- Leave the fridge door open to prevent any unpleasant smells from building up while the appliance is not in use.

Installation

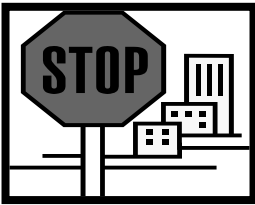

IMPORTANT: Before installation and usage read all the instructions and make sure that the voltage (V) and the frequency (Hz) indicated on the rating plate are exactly the same as the voltage and frequency in your home. The rating plate can be found on the front left edge of the inside of the refrigerator.

The manufacturer declines all responsibility in the event of the installer failing to observe all the accident prevention regulations in force, which are necessary for normal use and the regular operation of the electric system.

Electrical connection



YOUR FRIDGE IS INTENDED FOR FITTED AND PERMANENT INSTALLATION.

We recommend that the appliance is connected by a qualified electrician, who is a member of the N.I.C.E.I.C. and who will comply with the I.E.E. and local regulations.

- Your refrigerator comes supplied with a 13 amp plug fitted. If in future you need to change the fuse in this plug, then a 13 amp ASTA approved (BS 1362) fuse **must** be used.
- The wiring in the mains lead is coloured as follows:

Brown	Live
Blue	Neutral
Green and yellow	Earth
- As the colours of the wires in the appliance's mains lead may not correspond with the coloured markings identifying the terminals in your spur box, please proceed as follows:

The **brown wire** must be connected to the terminal marked "L" (live), or coloured **red**.

The **blue wire** must be connected to the terminal marked "N" (neutral), or coloured **black**.

The **green and yellow wire** must be connected to the terminal marked "E" (earth), or by the earth symbol, or coloured **green and yellow**.

- When the connection is completed, no stray strands or cut wire should be present. The cord clamp must be secured over the outer sheath.

Positioning

- It is advisable that your appliance is only installed in a location where the ambient temperature of the room, corresponds with the climate classification that is stated on the rating plate of your appliance. Your appliance may not function correctly if the ambient temperature falls outside of the following ranges.

<i>Climate classification</i>	<i>Appropriate ambient temperature</i>
SN	+10°C to +32°C
N	+16°C to +32°C
ST	+18°C to +38°C
T	+18°C to +43°C

- Positioning the appliance requires two people in order to avoid injuries or damage to the appliance.
- Your appliance should not be located in direct sunlight or exposed to continuous heat or extremes of temperature (e.g. next to a radiator or boiler). If this is not feasible, then you should install an insulation plate between the appliance and the adjacent heat source.
- You should check whether there is an electrical socket available, which will be accessible after your appliance is installed.
- Place the appliance flatly and firmly on a solid base. The appliance is fitted with adjustable feet on the front side, which can be used to level the appliance.
- Anything positioned above the appliance must allow sufficient cooling of the condenser with an approximate gap of 3 cm. You must leave a 2 cm gap to the rear of the appliance and 2 cm either side of the appliance.
- If you are placing another cooling appliance next door to this product, then there must be a gap of at least 2 cm between the appliances. This will help to prevent condensation from forming.
- Be sure to leave enough space for the opening of the door, to avoid damage to the appliance or personal injury.

Levelling the appliance

- If the fridge is not levelled during installation, the door may not close or seal properly causing cooling, frost or moisture problems.
- To level your fridge you may either turn the levelling foot clockwise to raise that side of the fridge or turn it anti-clockwise to lower that side.

IMPORTANT: This process should be carried by two people. While one person adjusts the foot, the other should push against the top of the fridge to take some weight off the levelling foot. This makes it easier to adjust the levelling foot.

Reversing the door

IMPORTANT: BEFORE COMMENCING THE DOOR REVERSAL PROCESS THE APPLIANCE MUST BE DISCONNECTED FROM YOUR MAINS SUPPLY.

- We suggest that two people complete the door reversal process.
- We recommend that the door reversal process is done before the appliance is placed in its final position.
- If food is already stored inside of it, then this must all be removed before beginning the door reversal process.

To change the door opening direction, please follow the instructions on the following pages:

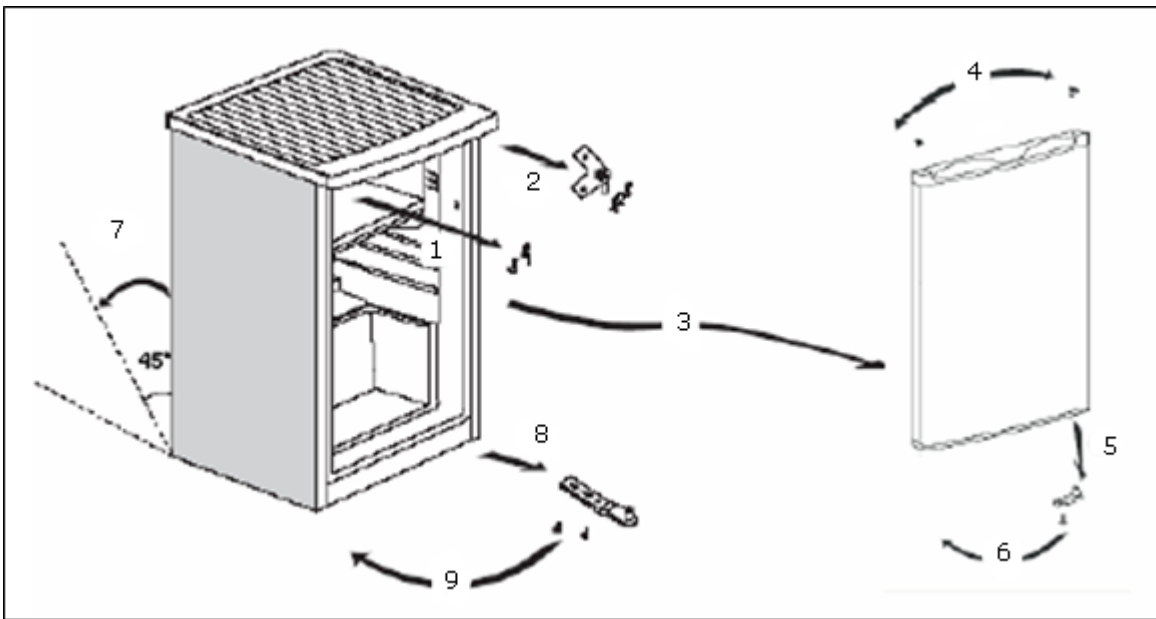

- 1) Switch off the appliance and unplug it. Remove all contents and shelving.
- 2) Unscrew the two screws on the top right hinge and remove it.
- 3) Gently pull out the door and remove it. Place it somewhere cushioned and safe from damage.
- 4) Relocate the hole cover in the top of the door to the opposite side of the door.
- 5) Remove the bottom right door stopper.
- 6) Move the bottom door stopper over to the opposite side of the door.
- 7) Tilt the appliance backwards by no more than 45°.
- 8) Remove the lower hinge by unscrewing the two screws.
- 9) Attach the lower hinge to the opposite side using the screws.

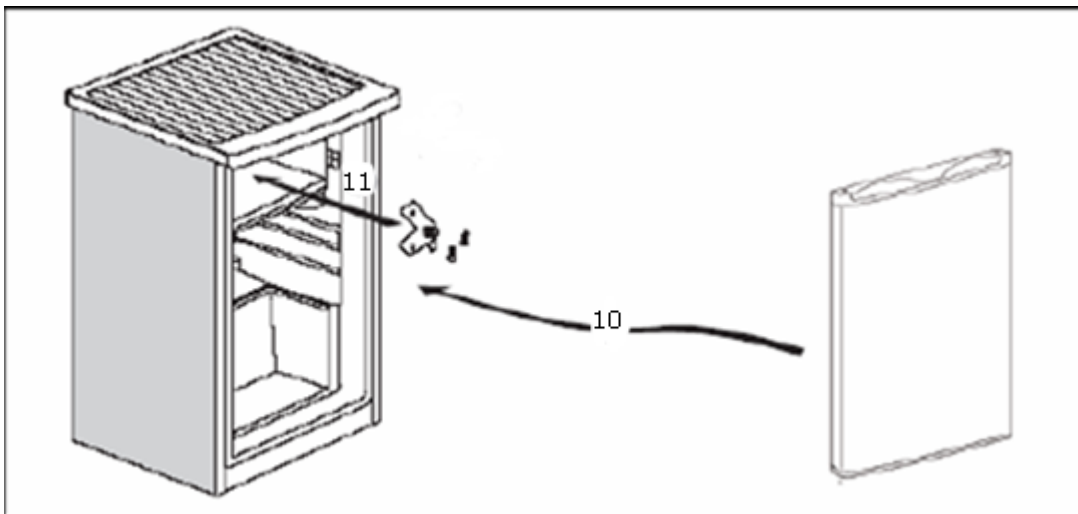

10) Re-attach the door by sitting the door on the bottom hinge.

11) Attach the top hinge/screws from step 2 to the opposite side and secure the door by the top hinge.

IMPORTANT: Check that the door opens and shuts correctly, without fouling, after you have completed the door reversal process.



After the door has been reversed, you should check the door seal of the appliance. The seal should not be creased or crushed; otherwise there will be a gap between it and the inside of the door.

- The seal must adhere properly all the way around the door.
- If the seal is not adhering to the cabinet properly, then you should either: -
 1. Use a warm damp cloth and manipulate the seal until it does adhere to the cabinet properly, all the way around the door.

OR

2. Use a hair dryer on its lowest heat setting and lightly heat the areas of the door seal that are not adhering correctly. The heat will make the seal more pliable and this will allow you to manipulate the seal into the correct position.

IMPORTANT: DO NOT HEAT THE DOOR SEAL ON ANYTHING BUT THE LOWEST HEAT SETTING, OR HEAT THE SEAL FOR A LONG PERIOD OF TIME. OTHERWISE DAMAGE MAY BE CAUSED TO THE DOOR SEAL, WHICH WOULD NOT BE RECTIFIED UNDER THE GUARANTEE FREE OF CHARGE.

IMPORTANT: WHEN YOU HAVE REVERSED THE DOOR OF THE APPLIANCE. AS YOU HAVE TILTED THE APPLIANCE BACKWARDS, YOU MUST WAIT FOR 8 HOURS BEFORE SWITCHING THE APPLIANCE BACK ON.

Troubleshooting



IMPORTANT: *If your fridge appears not to be operating properly, before contacting the Baumatic Customer Care Department, please refer to the checklist below.*



My fridge does not appear to be working/there is no power to my appliance.

- Check that the plug is fully inserted into the power socket.
- Check that there is power to your mains supply (e.g. that there hasn't been a power cut or that the fuse hasn't blown).
- Check that the thermostat inside the appliance has not been turned to the off position.
- Check that your mains supply voltage, corresponds to the voltage stated on the rating plate of your appliance.



My fridge appears to be performing poorly.

- Check that the appliance isn't overloaded and that food hasn't been packed too tightly into it.
- The thermostat setting is too low; you should turn the thermostat up higher.
- Ensure that the door is closing properly and that the door has not been opened for a prolonged period in error.
- Ensure that there is adequate ventilation for your appliance.



My fridge is noisy.

- The refrigerant gas that circulates the pipework of the appliance may make a slight noise, even if the compressor is not running.
- If the noise worsens or the appliance gets louder than normal; check that it is levelled off correctly, that nothing is touching the rear of the fridge and that nothing placed inside the appliance is rattling.



A thick ice sheet has formed on the inner back wall of my fridge.

- Check that food has not been pushed too far back inside the appliance, so that it is in contact with the inner back wall.
- The formation of ice droplets on the inner back wall does not indicate a product fault.



There is water in the base of the fridge or leaking out of my fridge.

- Follow "The defrost drain hole" section.



IMPORTANT: If your appliance appears not to be operating correctly, then you should disconnect it from your mains supply and then contact the Customer Care Department on telephone number (0118) 933 6911.

DO NOT ATTEMPT TO REPAIR THE APPLIANCE YOURSELF.

Please note that if an engineer is asked to attend whilst the product is under guarantee and finds that the problem is not the result of an appliance fault, then you may be liable for the cost of the call out charge.

The appliance must be accessible for the engineer to perform any necessary repair. If your appliance is installed in such a way that an engineer is concerned that damage will be caused to the appliance or your kitchen, then he will not complete a repair.

This includes situations where appliances have been tiled in, sealed in with sealant, have wooden obstructions placed in front of the appliance, like plinths. Or any installation other than the one specified by Baumatic Ltd. has been completed.

Please refer to the conditions of guarantee that appear on the warranty card that you receive with the appliance.

IMPORTANT: Baumatic Ltd. operates a policy of continuous improvement and reserves the right to adjust and modify its products without prior notification.

Baumatic Consumables

- **BC001** Degreaser for Dishwashers (200 g)
- **BC002** Descaler for Washing Machines and Dishwashers (200 g)
- **BC003** Ceramic Hob Cleaner (250 ml)
- **BC004** Oven Cleaner (250 ml)
- **BC005** Stainless Steel Cleaner and Protector (250 ml)
- **BC007** E-Cloth – General Purpose Cloth
- **BC008** Microwave Cover

To order a Baumatic consumable product please call 0123 5437 244 and quote the product code. You can also order online from eshop.baumatic.co.uk

Technical Data

Manufacturer	BAUMATIC LTD
Model Number	BF555SE
Product Category	7 – Refrigerator-Freezer
Energy Efficiency Class (1)	A+
Annual Energy Consumption (2)	161 kWh
Storage Volume of Fridge Compartment	93 litres
Storage Volume of Freezer Compartment	12 litres
Star Rating	4
Frost Free Compartments	Fridge
Temperature Rise Time	16 hours
Freezing Capacity	2kg/24hr
Climate Class (3)	ST
Noise Level	40 dB
Installation Type	Freestanding

(1) On a scale from A+++ (highest efficiency) to G (lowest efficiency).

(2) Annual energy consumption based on standard test results for 24 hours. The actual energy consumption will depend on how the appliance is used and where it is located.

(3) This appliance is intended to be used at an ambient temperature between "18°C" (lowest temperature) and "38°C" (highest temperature).



United Kingdom

Baumatic Ltd.,
Baumatic Buildings,
6 Bennet Road,
Reading, Berkshire
RG2 0QX
United Kingdom

Sales Telephone

(0118) 933 6900

Sales Fax

(0118) 931 0035

Customer Care Telephone

(0118) 933 6911

Customer Care Fax

(0118) 986 9124

Spares Telephone

(01235) 437244

Advice Line Telephone

(0118) 933 6933

E-mail:

sales@baumatic.co.uk
customercare@baumatic.co.uk
spares@baumatic.co.uk
technical@baumatic.co.uk

Website:

www.baumatic.co.uk

Facebook:

www.facebook.com/baumatic.uk

Republic of Ireland

Service Telephone

1-890 812 724

Spares Telephone

091 756 771

Czech Republic

Baumatic CR spol s.r.o.
Lípová 665
460 01 Liberec 4
Czech Republic

+420 483 577 200

www.baumatic.cz

Slovakia

Baumatic Slovakia, s.r.o.
Panenská 34
811 03 Bratislava - Staré Mesto
Slovakia

+421 255 640 618

www.baumatic.sk

Germany

Baumatic GmbH
Bachstr.10-12
D-32 257 Bünde
Deutschland

+49 (0) 5223 99408 0

www.baumatic.de

Italy

Baumatic Italia S.R.L.
Via Galvani N.3
35011 Campodarsego (PD)

+3904 9920 2297

www.baumatic.it

Holland

Baumatic Benelux B.V.
Dukdalfweg 15d
1332 BH ALMERE
Nederland

+31(0)36 549 1553

www.baumatic.nl

