

BUSH

Electric Cooker

Installation & User Instructions - Please keep for future reference

Cat no

2745291

2763967

Model

BUSH BESC60W WHITE

BUSH BESC60B BLACK



Cooker serial number *place sticker here*

Important – Please read these instructions fully before installing or using

These instructions contain important information which will help you get the best from your appliance and ensure safe and correct installation, use and maintenance.

If you need help or have damaged or missing parts, call **Argos Product Support 01759 487838**

Contents

Safety Information	2
Parts	3
Installation	4-5
Positioning	4
Fixing to the wall	4
Electrical connection	5
User Instructions	6-8
Using the hob	6
Cookware selection	6
Using the oven	7
Using the grill	8
Care and Maintenance	9
Cleaning	9
Removing the inner door glass	9
Troubleshooting	10
Technical Specifications	11
Disposal information	11
A Guide to Wall Mounting & Fixings	12
Guarantee	Back





Safety Information

Important – Please read these instructions fully before installation

IMPORTANT: This product MUST be installed by a qualified installer in accordance with local regulations.

IMPORTANT: This appliance has been designed for non-professional, domestic use only.

IMPORTANT: Carefully unpack and examine the appliance for any damage. If you think there is a defect, do not use the appliance and contact Argos Product Support on **01759 487838**.

IMPORTANT: The cooker is supplied setup according to the conditions shown on the rating label which is stuck to the rear of the appliance.

IMPORTANT: Keep the electrical cable (not supplied) of your cooker away from the hot areas; do not let it touch the appliance. Keep the cable away from sharp edges and heated surfaces.

IMPORTANT: In the event that the cable connecting your cooker becomes damaged, it must be replaced by a suitably qualified person. **This cable must not be replaced by an unauthorised person.**

IMPORTANT: When using the grill the oven door must be kept closed to prevent damage to the cooker knobs and to prevent the burn hazard that very hot knobs would present.

IMPORTANT: Children and persons with reduced physical, sensory or mental capabilities or lack of experience and knowledge should not be allowed to use the cooker unless supervised and warned of the hazards involved

WARNING: The appliance and its accessible parts become hot during use. Care should be taken to avoid touching hot parts.

WARNING: Cooking on a hob with fat or oil can be dangerous and should not be left unattended.

WARNING: NEVER try to extinguish a cooking fire with water. Instead switch off the appliance and cover flame e.g. with a lid or a fire blanket.

WARNING: Danger of fire: do not store items on the cooking surfaces or in the oven.

CAUTION: Cookers may topple forward if a child climbs onto the cooker door. Children should be supervised in the kitchen at all times and this cooker must be secured to the wall using the fixing points provided to prevent accidents.

CAUTION: Do not allow children in the kitchen when cooking or while cooker parts may still be hot. Many parts of the cooker will become hot and present a considerable hazard to children.

CAUTION: When the oven is hot never touch the oven glass by hand or with tools.

CAUTION: Before starting to use your appliance, ensure curtains, paper or flammable items are kept away from your appliance. Do not keep flammable materials inside of or around your cooker.

CAUTION: Take care when closing the oven door that there is nothing obstructing it from closing as this may break the glass door.

Parts

If you have damaged or missing parts,
call **Argos Product Support 01759 487838**

Please familiarise yourself with the parts and accessories listed below

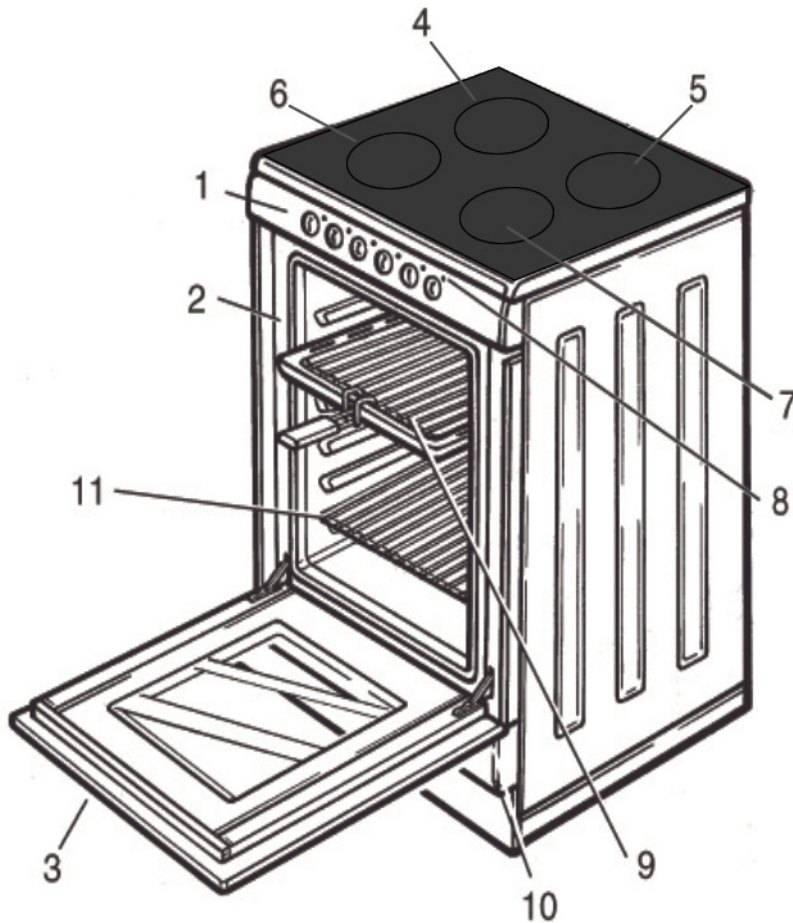

- 1 - Control panel
- 2 - Oven and Grill
- 3 - Oven door
- 4 - Zone left rear
- 5 - Zone right rear
- 6 - Zone left front
- 7 - Zone right front
- 8 - Hob heat indicator
- 9 - Grill pan with removable handle
- 10 - Panel
- 11 - Wire shelves X 2

Accessories

Grill pan and handle set



2 wire shelves



Shelf orientation



Positioning and fixing to the wall

Positioning

1. Make sure that there are no combustible or flammable materials, such as curtains, in the vicinity of the installation.
2. Furniture and cabinets surrounding the cooker must be of material resistant to temperatures greater than 50°C.
3. Surrounding furniture, cabinets and extractor fans should be positioned in accordance with the diagram shown in Figure 1.
4. There must be at least 2cm of free space between the back wall and the rear of the appliance to allow for ventilation and air circulation.
5. If fitted, the extractor fan must be at least 65cm above the hob. If no fan is fitted the minimum distance between the hob and any cabinet or other structure must be 75cm.

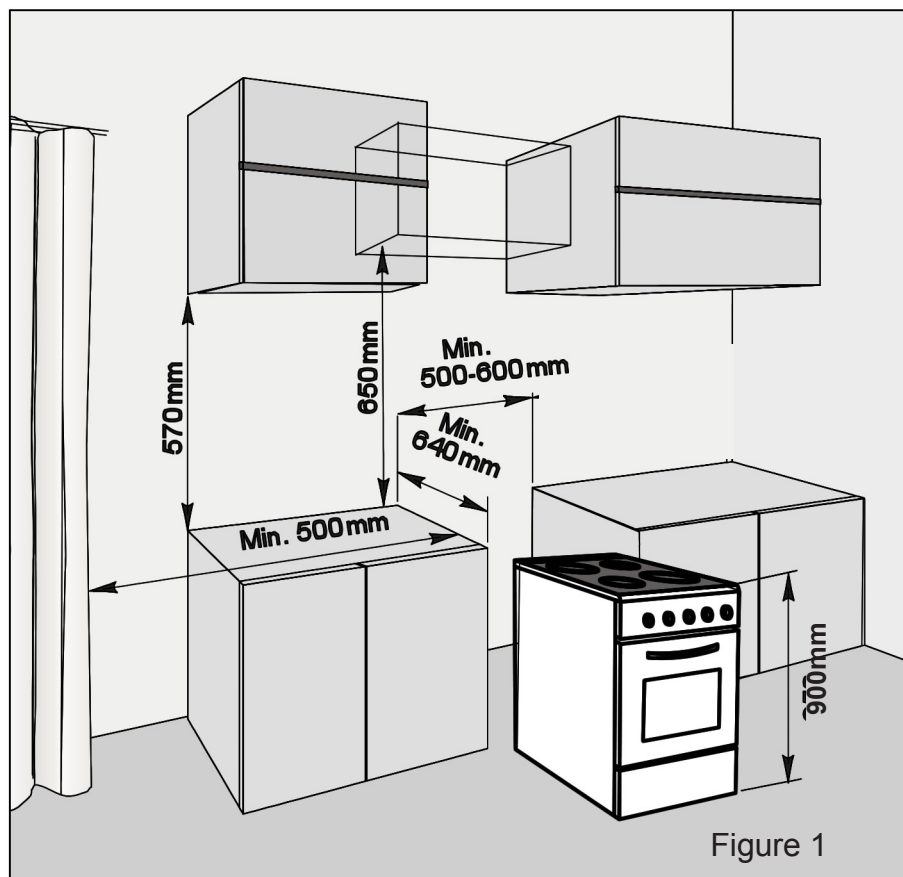

Figure 1

Fixing to the wall

Before using the appliance fix it securely to the wall using the chains on the back of the cooker. This will prevent the cooker from toppling forward if excess weight is placed on the oven door. Since the chains must be attached to wall fixings suitable for your wall type, the wall fixings are not supplied with the cooker (Figure 2).

Please refer to the 'Guide to Wall Mounting and Fixings' on page 12.

Levelling

Level the cooker before using it. To do this, use the adjustable feet to achieve the correct level and height

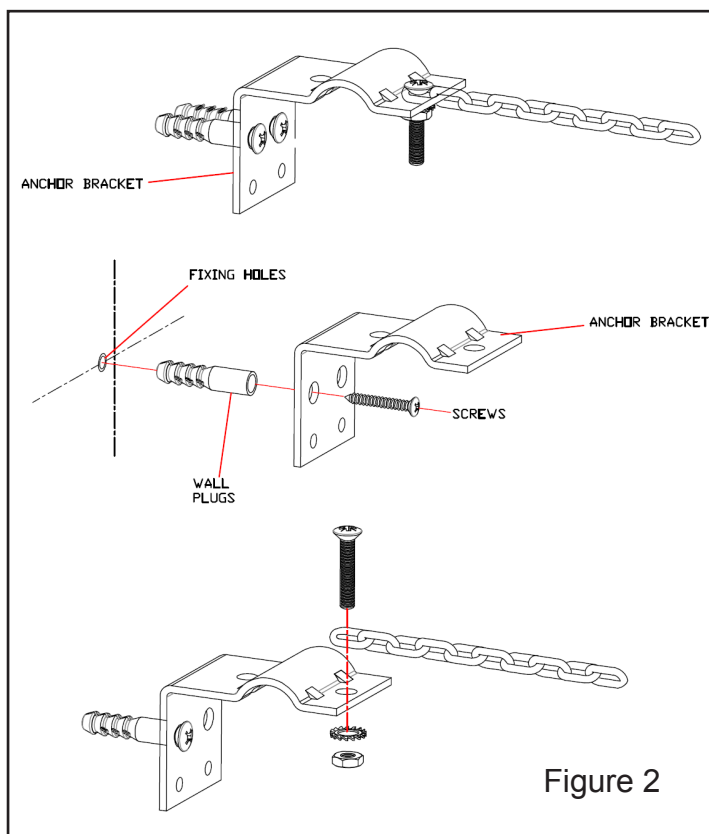

Figure 2

Electrical connection



IMPORTANT: Electrical connections must be carried out by a suitably qualified person and in accordance with all relevant local building and installation regulations.

3. Electrical cable should not touch the hot parts of the appliance.

The electrical cable should not be routed through any area that may be affected by heat from the oven, especially the area directly behind the oven.

1. See the rating label at the rear of the product for the appliance's rated load.

2. The cooker must be connected to a dedicated circuit suitably rated for the load of the appliance (see rating label at rear of appliance) as shown in the wiring diagrams below. It must be connected via a suitably rated cable to a double pole isolator cooker switch also suitably rated for the appliance.

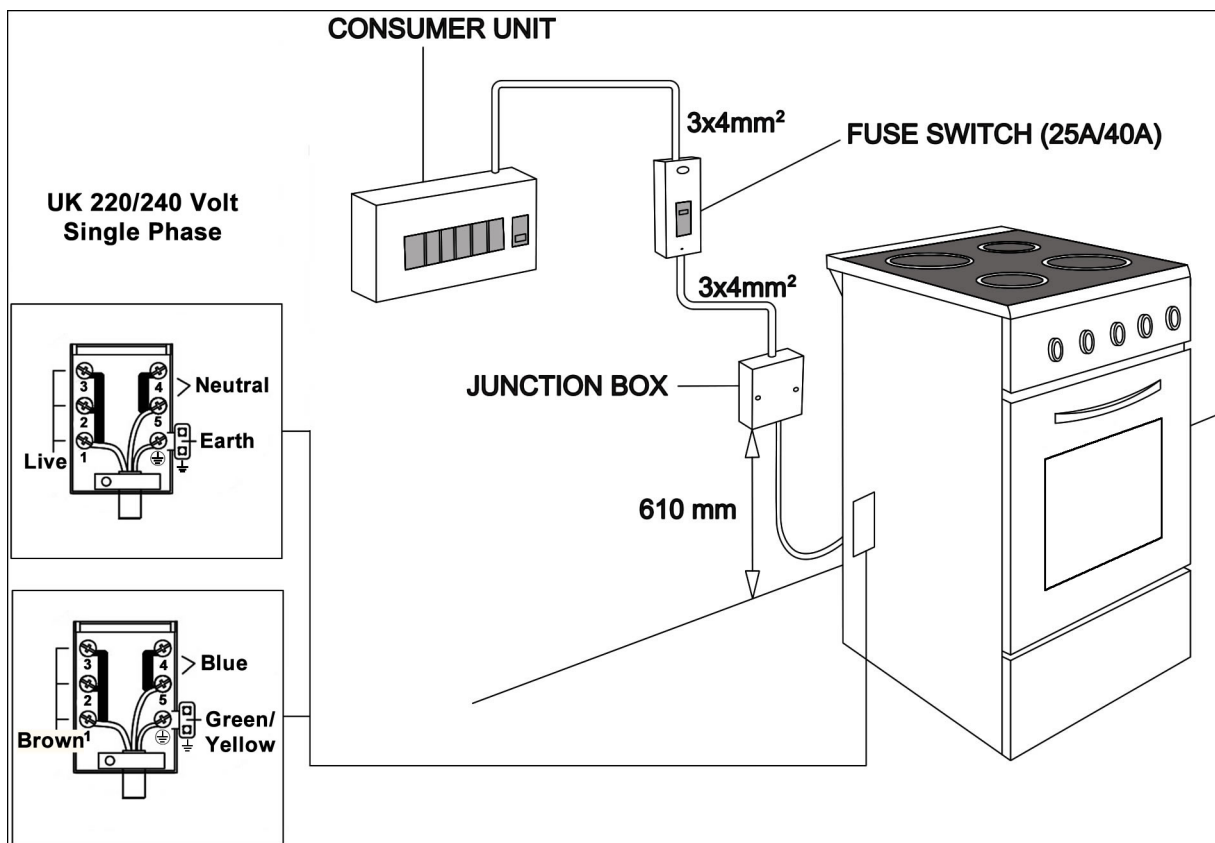

Using the Hob

Each ceramic hob is regulated by a selector knob (Fig. 3). The control allows for the efficient transfer of heat to the cooking pan.

The knob can be turned in both directions, to numbers 1 to 6

These numbers correspond to the power setting of the ceramic hob where 6 is the highest setting and 1 is the lowest.

Turn the hob control knob to off (●) when finished.

We recommend you turn off the ceramic hob 5 to 10 minutes before the dish is ready. This allows the heat accumulated in the ceramic hob to be used economically. The ceramic hob remains hot for a while after use.

SAFETY ADVICE IN THE CASE OF A COOKING PAN FIRE

In the event of a cooking pan fire:

1. Turn off the cooker at the wall switch.
2. Cover the pan with a fire blanket or damp cloth. This will smother the flames and extinguish the fire.
3. Leave the pan to cool for at least an hour before attempting to move it. Injuries are often caused by picking up a hot pan and rushing outside with it.

NEVER USE A FIRE EXTINGUISHER TO PUT OUT A PAN FIRE

as the force of the extinguisher could tip the pan over.

Never use water to extinguish oil or fat pan fires.

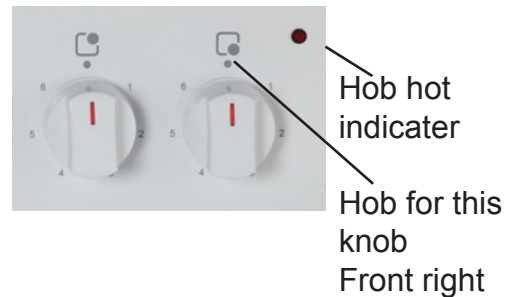

Figure 3

COOKWARE SELECTION

- Any cookware should have a thick, flat and dry base of the same diameter or slightly bigger than the hob. If the cookware diameter is smaller than the hob, heat will be wasted.
- Cookware with uneven bases is very inefficient, making the cooking time longer and wasting electricity.
- Cookware made of flameproof glass, suitable for ceramic hob cooking, should match the hob size. Pans projecting beyond the hob may be broken due to temperature stresses. The heated pan must never be filled up with cold water or placed on cold metal or stone surfaces.
- Always use the pan with its lid on. This prevents the accumulation of vapour in the kitchen.



Only use flat bottomed pans

IMPORTANT!

1. Never turn the hob on before placing a pan on it, except when first used.
2. If the ceramic hob is not to be used for a long time, apply a little grease to the painted surface.
3. Do not allow spills to be burned onto the hob as baked stains are harder to remove

Using the oven

Using the Fan Oven

Turn the oven selector knob to the required function then turn the temperature knob clockwise and align the marker on the control knob with the required temperature (°C)

The indicator light on the control panel will go out and the thermostat will turn the element off when the selected temperature has been reached inside the oven. These will come back on once the thermostat falls below the set value.

Fan only defrost

The fan can be used without heat to defrost food (DEFROST)

IMPORTANT! Before using this method of defrosting refer to the food packaging defrosting information

Always turn the control knob to off (●) when cooking has finished.

Please note: The appliance incorporates a safety thermostat which cuts the electric supply to the oven if the temperature becomes excessive.

When using your oven for the first time your cooker may give off an unusual odour from the heating elements. This is normal for new cookers. To eliminate this odour run the oven at 250 degrees for 40-60 mins with the oven empty.

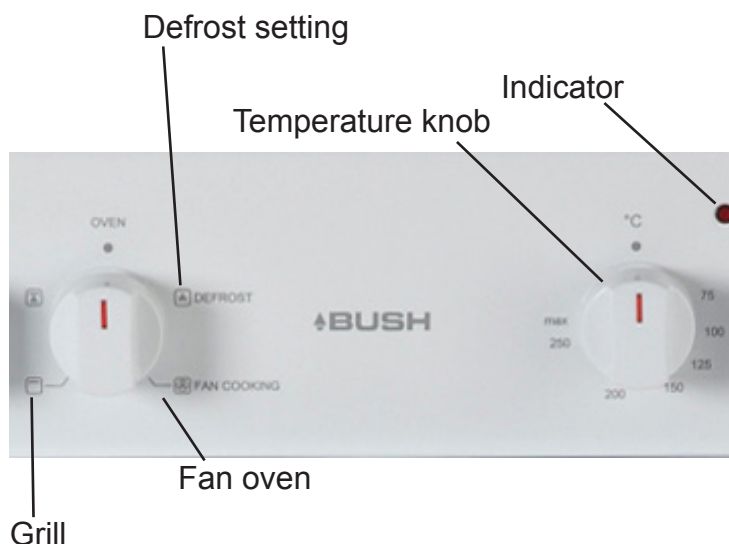

Using the grill

Using the grill

Turn the oven selector knob to grill.
Turn the temperature knob clockwise and align the marker on the control knob with the required temperature (°C)

The indicator light on the control panel will go out when the selected temperature has been reached inside the grill. This will come back on once the thermostat falls below the set value.

Always turn the control knob to off (●) when cooking has finished.

The GRILL door **must be closed** during use.

Always use the handle when handling the grill pan

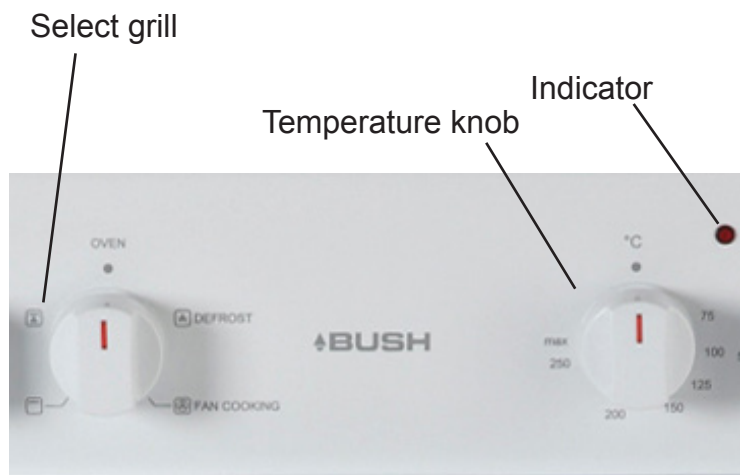

Cleaning

WARNING! Isolate the power supply to the cooker and make sure that the oven is cool.

Do not clean using caustic creams, abrasive cleaning powders, thick wire wool or hard tools. Enamelled parts of the oven can be damaged if excess cleaning liquids are not immediately removed.

After cleaning the interior parts of the oven with a soapy cloth, rinse it and then dry thoroughly with a soft cloth.

Clean the glass surfaces with special glass cleaning agents.

Never use flammable agents like acid, thinner or petrol when cleaning your oven.

Do not clean your oven with a steam cleaner.

Do not wash any part of your oven in a dishwasher.

Removal of inner glass door for cleaning

Remove the inner glass by sliding the glass out towards you.

Care and use of the ceramic hob

For best results use pans with thick flat bases and match cooking pans to cooking zones of equal size.

Always place the pan on the cooking zone before switching on the cooking zone.

Always disconnect the power and check that the hob is cool before cleaning.

Do not use harsh or abrasive cleaning agents or abrasive cleaning products such as wire wool to clean the hob. Use only cleaning products designed to be used on ceramic hobs.

Troubleshooting

Argos Product Support 01759 487838

If your cooker does not appear to function correctly

1. If no functions appear to work, check the cooker isolation switch has not been turned off also check the fuse in the switch and the circuit breaker in you consumer unit

2. After replacing the fuse or resetting the circuit breaker turn on individual parts of your cooker one at a time to check function

3. **DO NOT** attempt to repair this cooker yourself. Call Argos Product Support or consult a qualified electrician

Problem	Possible Cause	Solution
Only parts of the cooker work it may be that the hobs, the ovens or the grill, do not work	Links may be missing in the rear connector box	Refer to the Quick Start Guide to check the correct placement of the links This must be done by a qualified competent person
Nothing works (completely dead)	Power is turned off at the isolation switch or the consumer unit Poor electrical connection	Ensure isolation switch is on Check consumer unit has not tripped out Have the connections checked by a qualified electrician
Oven not heating up	Oven temperature not set correctly Door is not properly closed	Ensure that the correct temperature has been selected and the door is properly closed

Technical Specifications

Argos Product Support 01759 487838

Models	BUSH BESC60 BLACK or WHITE
Power supply	220-240V~50 Hz
Maximum power	8000 W
Size (H x W x D)	900 x 600 x 600
Net Weight	41.F4Kg
Oven volume	67 Lt.
Energy rating	A

We apologise for any inconvenience caused by minor inconsistencies within these instructions that may occur due to product improvements and development

All images and drawing are for illustration purposes only.



This appliance/fitting is marked according to the European directive 2002/96/EC on Waste Electrical and Electronic Equipment (WEEE). By ensuring this product is disposed of correctly, you will help prevent potential negative consequences for the environment and human health, which could otherwise be caused by inappropriate waste handling of this product.

The symbol on the product, or on the documents accompanying the product, the **crossed out wheellie bin** symbol, indicates that this appliance/fitting may not be treated as household waste. Instead it shall be handed over to the applicable collection point for the recycling of electrical and electronic equipment. Disposal must be carried out in accordance with local environmental regulations for waste disposal. For more detailed information about treatment, recovery and recycling of this product, please contact your local authority, your household waste disposal service or the retailer where you purchased the product.

Wall Fixing Guide

Argos Product Support 01759 487838

Important note:

If plastic wall plugs are supplied with your product:



- these are only suitable for use in masonry walls.

If you are in any doubt about the correct wall plugs for your wall, seek professional advice.

Failure of the product due to using incorrect fixings is the responsibility of the installer.



Important: When drilling into walls always check that there are no hidden wires or pipes etc.

Make sure that the screws and wall plugs being used are suitable for supporting your unit. Consult a qualified tradesperson if you are unsure.

Hints:

- 1: General rule:  Always use a larger screw and wall plug if you are not sure.
- 2: Ensure you use the recommended drill bit to match the wall plug and hole size.
- 3: Ensure you drill the hole horizontally, do not force the drill or enlarge the hole.
- 4: Take extra care when drilling high walls, ceilings and ceramic tiles. Ensure wall plugs are inserted beyond the thickness of the ceramic tiles to avoid the tiles splitting or cracking.
- 5: Ensure wall plugs are well fitted and are a tight fit in the drilled hole.

Types of walls

You can use one of the following types of wall plug if your walls are made of brick, breeze block, concrete, stone or wood.

No.1 "General Purpose" wall plug

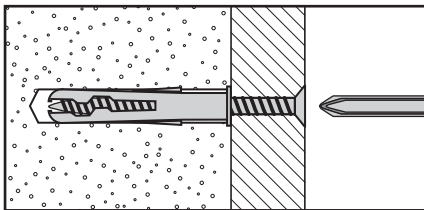

Generally aerated blocks should not be used to support heavy loads, use a specialist fitting in this case. For light loads, general purpose wall plugs can be used.

No.2 "Plasterboard" wall plug

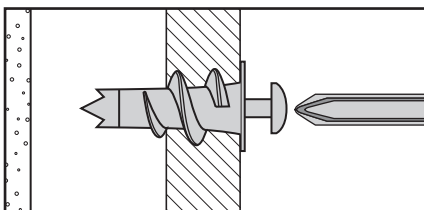

For use when attaching light loads on to plasterboard partitions.

No.3 "Cavity Fixing" wall plug

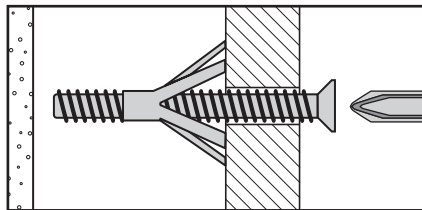

For use with plasterboard partitions or hollow wooden doors.

No.4 "Cavity Fixing-Heavy Duty" wall plug

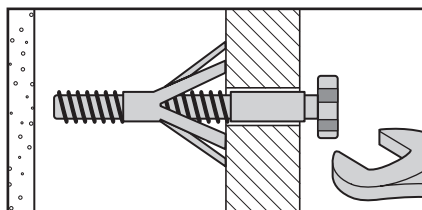

For use when fitting or supporting heavy loads such as shelving, wall cabinets and coat racks.

No.5 "Hammer Fixing" wall plug

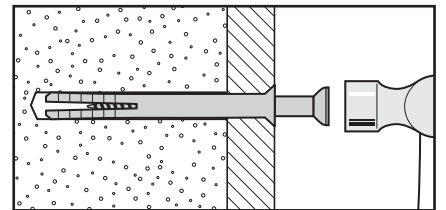

For use with walls stuck with plasterboard. The hammer fixing allows it to be fixed to the wall rather than the plasterboard. Always check the fixing is secure to the retaining wall.

No.6 "Shield Anchor" wall plug Heavy loads

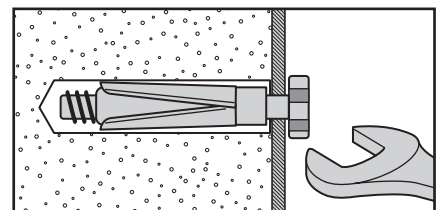

For use with heavier loads such as TV & HiFi speakers and satellite dishes etc.



Care & Maintenance

Safety: Always check the fitting and location to ensure your safety in and around the home.

Fitting: From time to time check the fitting to ensure the wall plugs or screws do not become loose.



Product Guarantee

This product is guaranteed against manufacturing defects for a period of



This product is guaranteed for 12 months from the date of original purchase. Any defect that arises during this period due to faulty materials or workmanship will either be repaired free of charge or replaced.

The guarantee is subject to the following provisions:

- The guarantee does not cover accidental damage, misuse, cabinet parts, knobs or consumable items.
- The product must be correctly installed and operated in accordance with the instructions contained in this manual.
- It must be used solely for domestic purpose.
- The guarantee will be rendered invalidated if the product is re-sold or has been damaged by inexpert repair.
- Specifications are subject to change without notice.
- The manufacturer disclaims any liability for the incidental or consequential damages.
- The guarantee is in addition to, and does not diminish your statutory or legal rights.
- In the event of a problem with the product with in the guarantee period call :-
Argos Product Support 01759 487838.

Guarantor: Argos Ltd
489 - 499 Avebury Boulevard
Central Milton Keynes
MK9 2NW