

**BWC1215SS**  
**94 Bottle Wine**  
**Cabinet**

**INSTRUCTION MANUAL**

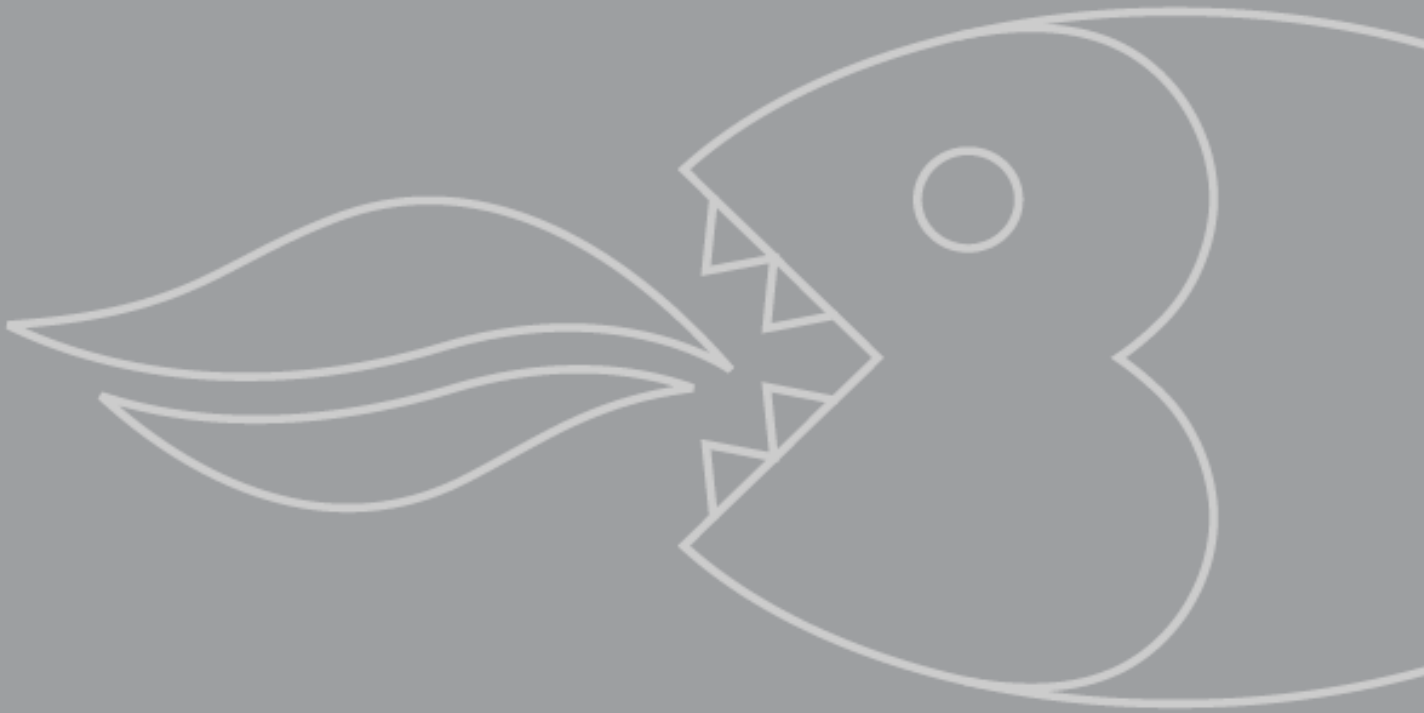

# USER MANUAL FOR YOUR BAUMATIC

## BWC1215SS

94 bottle dual temperature  
electronic wine cabinet



***NOTE: This User Instruction Manual contains important information, including safety & installation points, which will enable you to get the most out of your appliance. Please keep it in a safe place so that it is easily available for future reference, for you or any person not familiar with the operation of the appliance.***

GS 01/05/13

# Contents

<b>Environmental note</b>	4
<b>Important safety information</b>	5 – 7
<b>Specifications of your wine cabinet</b>	7 – 8
Dimensions	7
Product specifications	7 - 8
<b>Description of the appliance</b>	8-10
Product features	8
Control panel	9
Description of the product features	9-10
<b>Using your Baumatic wine cabinet</b>	10-15
Before switching on	10
During first use	11
Turning the appliance on and off	11
Unlocking the control panel	11
The interior light	12
Setting the temperature	12
Changing between Fahrenheit and Celsius	12
Loading the wine cabinet	13
Storing your wines	13-14
Wine storage problems	15
<b>Cleaning and maintenance</b>	16-17
Defrosting	16-17
Moving your wine cabinet	17
Power failure	17
Vacation time	17
<b>Installation</b>	18-26
Electrical connection	18-19
Positioning	19-20
Installing the handle	20
Reversing the door of your wine cabinet	21-24
Reversing the door handle	24-26
<b>Troubleshooting</b>	26-28
<b>Baumatic consumables</b>	29
<b>Technical data</b>	30
<b>Contact details</b>	31

## Environmental note

***Note: Before discarding an old appliance, switch off and disconnect it from the power supply. Cut off and render any plug useless. Cut the cable off directly behind the appliance to prevent misuse. This should be undertaken by a competent person. Disable the door lock to make sure that children cannot get stuck inside the appliance.***

**This appliance is marked according to the European directive 2002/96/EC on Waste electrical and Electronic Equipment (WEEE). By ensuring this product is disposed of correctly, you will help prevent potential negative consequences for the environment and human health, which could otherwise be caused by inappropriate waste handling of this product.**

The symbol  on the product, or on the documents accompanying the product, indicates that this appliance may not be treated as household waste. Instead it shall be handed over to the applicable collection point for the recycling of electrical and electronic equipment.

**Disposal must be carried out in accordance with local environmental regulations for waste disposal.**

**For more detailed information about treatment, recovery and recycling of this product, please contact your local city office, your household waste disposal service or the shop where you purchased the product.**



- The packaging materials that Baumatic uses are environmentally friendly and can be recycled.
- Please discard all packaging material with due regard for the environment.

## Important safety information



Your safety is of the utmost importance to Baumatic. Please make sure that you read this instruction booklet **before** attempting to install or use the appliance. If you are unsure of any of the information contained in this booklet, please contact the Baumatic Customer Care Department.

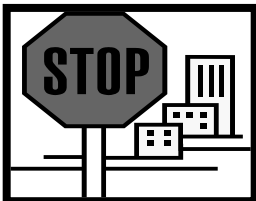

**IMPORTANT:** Any installation work must be carried out by a qualified electrician or competent person.

### Use of the appliance

- Your appliance is only designed to be used in the home. This appliance is intended to be used exclusively for the storage of wine. If it is used for any other purpose or it is not used correctly, then Baumatic Ltd. will accept no liability for any damage that is caused.



- Altering the specification of the appliance must not be attempted for reasons of safety.

### Before using your appliance

- Check the appliance for any signs of transport damage. If you notice any damage, then you should not connect your appliance to your mains supply and should contact your retailer.

### Refrigerant

- Your appliance contains R600a refrigerant, which is a natural gas that does not contain CFCs that can damage the environment. However it is a flammable substance, therefore care should be taken:
  - During the transportation and installation of the appliance, make sure that the refrigeration pipework does not get damaged.
  - If it does become damaged then sources of ignition and open flames should be avoided. Also the room that the appliance is situated in should be thoroughly ventilated.

- Do not place any objects on top of the appliance, as this may damage the table top.



## Child safety

- Packaging material should be kept away from children.
- This appliance is intended for use by persons with sufficient experience and knowledge of electrical appliances. Any other persons (including children) should be supervised or given instruction concerning use of the appliance by a person responsible for their safety.
- Children should be supervised to ensure that they do not play with the appliance.



## General safety

- Do not pull on the power supply cable to remove the plug from your mains supply socket.
- Do not pull out or insert the plug with wet hands.
- Do not attempt to use your appliance outdoors or any place where it is likely to come into contact with the elements.
- Before cleaning the appliance or performing maintenance work, ensure that the appliance has been disconnected from your mains supply.
- Never allow the back coils of the appliance to come into contact with the wall surface.
- Always ensure that the location where you are installing your appliance is free of stored items such as papers and other flammable materials.
- Never block the ventilation openings of the appliance, either on the inside or its exterior.
- It is vital to keep your appliance well ventilated, so that there is proper air flow between the bottom of the unit and the plinth/kick plate which it is sitting on.
- Do not place electrical devices inside of the appliance, such as mixers or ice cream makers.

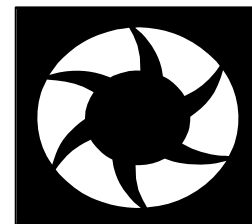
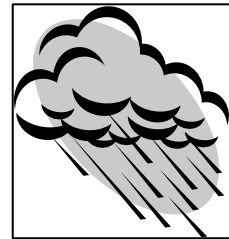

## Service

You should not attempt to repair the appliance yourself, as this could cause injury or a more serious malfunction. If you require a service call then please contact the Customer Care Department.

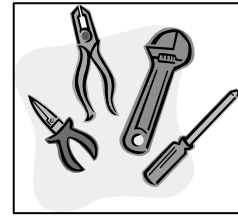

## Specifications of your wine cabinet

### Dimensions of appliance

Height: 1215 mm  
Width: 595 mm  
Depth: 680 mm

- Gross capacity: 270 litres
- Net capacity: 266 litres
- Bottle capacity: 94 x 0.75 litre Bordeaux style wine bottles
- Energy efficiency class: D
- Noise level: 40 dB
- Fan assisted operation
- LED display
- Celsius and Fahrenheit switch
- 8 wooden shelves
- Adjustable temperature
- Internal light
- Tempered door glass
- Water drainage
- Two individual temperature zones
- Upper zone compartment: 5°C - 12°C
- Lower zone compartment: 12°C - 22°C
- Reversible door
- Adjustable feet
- Smoked door glass
- Stainless steel door frame
- Black interior and exterior

***IMPORTANT:*** When you install your appliance it is important to bear in mind its climatic rating.

In order to find out the climatic rating of your appliance, you should check the rating plate. The rating plate is located on the front left edge of the appliance. The rating plate will indicate the ambient temperature range that your appliance will function correctly within. It is also advisable to make a note of the model number and the serial number of the appliance before installing it.

Model number .....

Serial number .....

Date of purchase .....

**Description of the appliance**

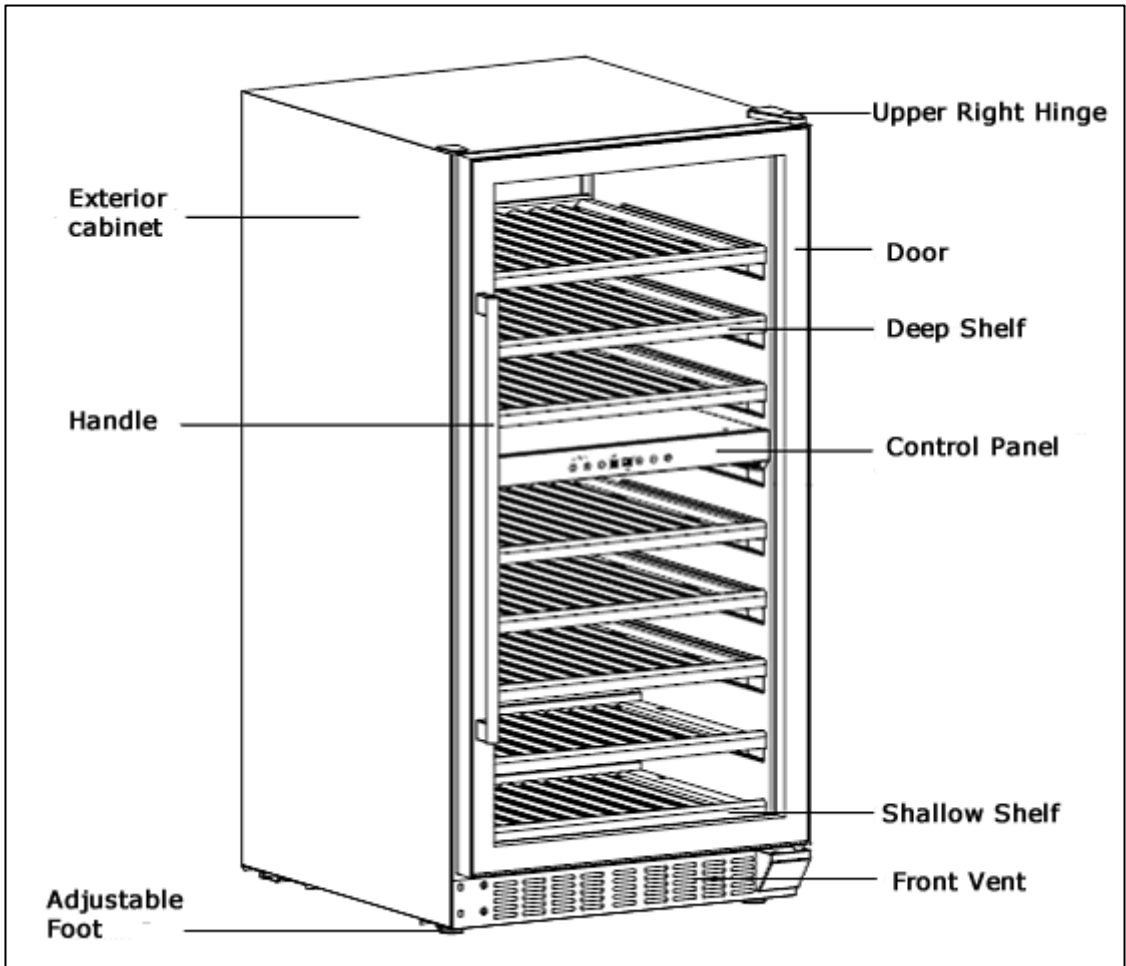



## Control panel

*The control panel is located in the middle of the appliance.*

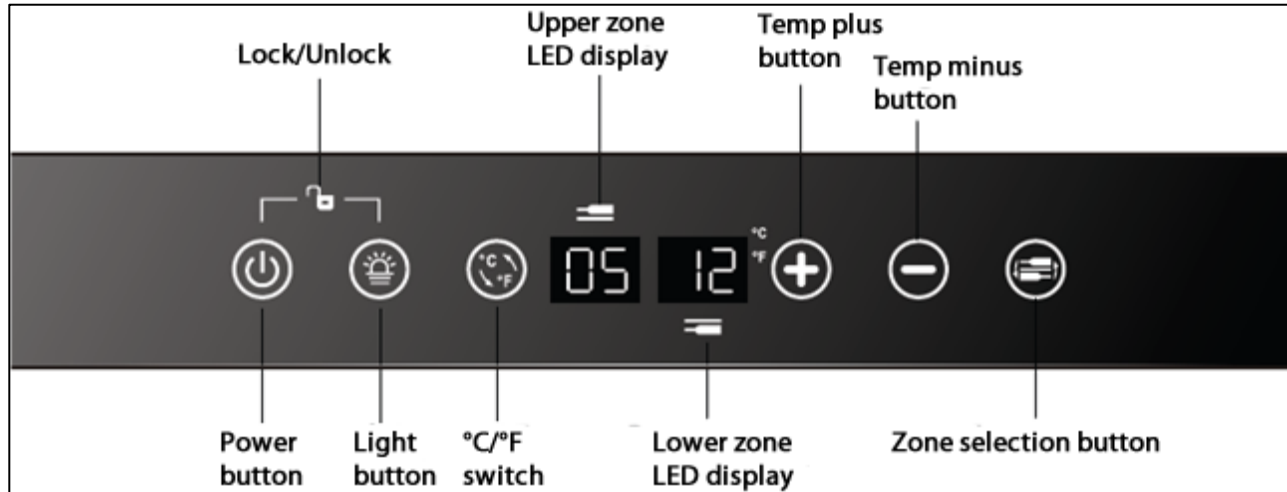

## Description of the product features

### ***Control panel***

- The control panel is located in the middle of the appliance, behind the glass door. This means it is easy to set the temperature of the appliance and see what temperature the appliance is set to.

### ***Two cooling zones***

- There are two cooling zones inside of your wine cabinet.
- Each cooling zone has a separate temperature control and temperature display.

### ***Interior light***

- The cooling zone has an interior light. The light can be switched on and off by using the light button.

### ***The wine cooler shelves***

- To prevent damaging the door gasket, make sure the door is fully open when pulling shelves out of the rail compartment.
- For easy access to the bottles stored, pull the shelves out approximately 1/3 of the way. The shallow shelves do not have telescopic rails but have a plastic stopper on each side of the interior cabinet to prevent the shelf from falling out.

- All of the deep shelves have telescopic rails which have stoppers of their own.

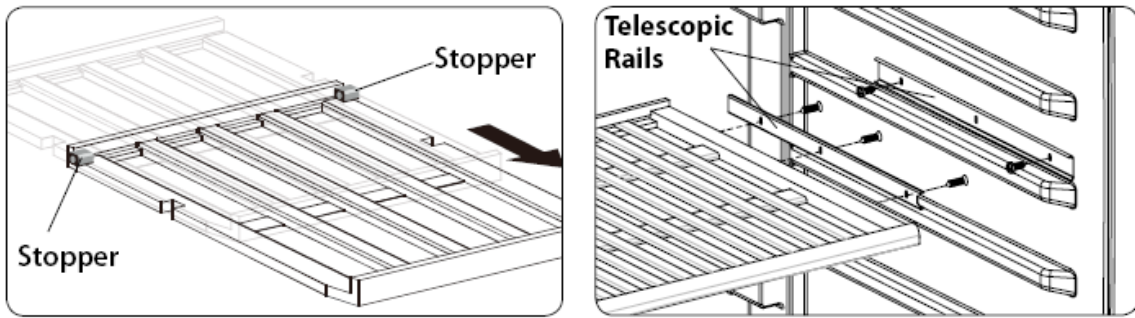

## Using your Baumatic wine cabinet

### Before switching on

- Make sure that it has been installed by a suitably qualified person, as per the information contained in Baumatic's installation instructions.
- After delivery, wait for eight hours before connecting the appliance to your mains supply. This will allow any refrigerant gasses that may have been disturbed during the transportation process to settle.
- The outside of the appliance and the removable accessories contained within it, should be cleaned with a solution of liquid detergent and water.
- The interior of the appliance should be cleaned with a solution of sodium bicarbonate dissolved in lukewarm water. The interior and accessories should be thoroughly dried, after the cleaning process has been completed.
- There can be an odour when you first switch on the appliance. It will lessen as the appliance starts to cool.

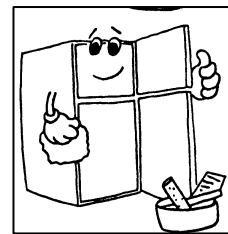

## During first use

***IMPORTANT: When you use the wine cabinet for the first time or restart the appliance after it has been turned off for a long time, there could be a few degrees variance between the temperature you select and the one indicated on the LED display. This is normal and it is due to the length of activation time. Once the wine cabinet has been running for a few hours everything will be back to normal.***

- When you first switch on the appliance, the compressor will run continuously until the wine cabinet reaches a cool enough temperature.
- During this period of time, you should try not to open the door frequently or place bottles inside of the appliance.
- If the unit is switched off or unplugged, you must allow at least 5 minutes before restarting the appliance or reconnecting it to your mains supply.

## Turning the appliance on and off

- When the wine cabinet is connected to the power outlet it will turn on automatically.



- Press and hold the power button for approximately 10 seconds to turn the appliance on and off.
- Even if the safety lock is activated, the appliance can still be turned off by pressing and holding the power button for about 10 seconds.

## Unlocking the control panel

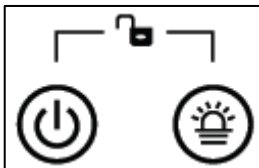

- To unlock the control panel press the power and light buttons simultaneously for about 3 seconds. A buzz will sound to indicate that the control panel has unlocked.
- The control panel will automatically lock after 10 seconds if no buttons are pressed. A buzz will sound to indicate that the control panel has locked.
- When the control panel is locked no buttons can be operated except for the power button to turn the appliance off.

## The interior light



- When the control panel is unlocked, you can use the light button to switch the interior light on and off.
- The light will remain on unless it is turned off manually by pressing the light button.

## Setting the temperature

- The temperature setting for the upper zone is adjustable within the range of 5°C - 12°C / 41°F - 54°F.
- The temperature setting for the lower zone is adjustable within the range of 12°C - 22°C / 54°F - 72°F.



- Use the zone selection button to choose which zone you want to set the temperature for. The relevant LED display will flash to show you can set the temperature for that zone.

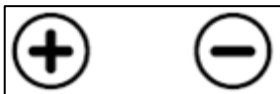

- Use the temperature plus and minus buttons to select the temperature you want the wine cabinet to operate at.
- The first touch of these buttons will automatically set the previous set temperature. However if the appliance has been unplugged or there has been a power failure, the first touch of these buttons will automatically set the default temperature of 10°C (50°F) for the upper zone and 16°C (61°F) for the lower zone.
- Each press of the temperature plus button will increase the set temperature by 1°C/1°F. Each press of the temperature minus button will decrease the set temperature by 1°C/1°F.
- When the display shows the desired temperature release all buttons and the display will change to show the actual temperature inside of the cabinet after about 10 seconds.

## Changing between Fahrenheit and Celsius

- You can select whether the temperature display shows Celsius or Fahrenheit.

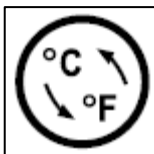

- To alter what the temperature display is showing, press the Celsius and Fahrenheit switch. This will change the temperature display for both cooling zones.

## Loading the wine cabinet



- **IMPORTANT:** Your appliance is ideally suited to store 0.75 litre Bordeaux style wine bottles. You must make sure that they do not prevent the door from shutting properly.
- Always check that you can close the door without it fouling on a wine bottle, before shutting it.
- When loading several bottles of wine at once, it will take longer for the appliance to cool the individual bottles.
- As many bottles may differ in size and dimensions, the actual number of bottles you are able to store may vary. The maximum storage number is based on standard 0.75 litre Bordeaux style wine bottles.

## Storing your wines

The chart below indicates the ideal storage temperatures for different types of wine: -

<b>Type of wine</b>	<b>Temperature (Celsius)</b>	<b>Temperature (Fahrenheit)</b>
Red wine (*)	15.5 – 18.5°C	59.9 – 65.3°F
White wine (**)	10 - 15°C	50 – 59°F
Sparkling wines/champagne	7.2 – 9.5°C	45 – 49.1°F
Rose wine	9.5 – 10.5°C	49.1 – 50.9°F
Vintage wine	13°C	55°F

\* Light red wines, such as Beaujolais, Pinot Noir and Cabernet Franc benefit from being served slightly cooler than full-bodied reds.

\*\* Chardonnay is often served too cold. You should chill it at a warmer temperature inside of your wine cabinet. Or leave it to warm slightly when you remove it from your wine cabinet.

- Temperature stability is the most important factor when it comes to storing wine.
- Exposure to light, vibrations or fluctuations in temperature and humidity can all cause wine to spoil. When properly stored, wines not only maintain their quality but many will actually improve in aroma, flavour and complexity as they mature.

- Wines kept at a higher temperature will age faster. Wine that is exposed to temperatures that are greater than 21°C (70°F) will suffer from poorer flavour and aroma.
- If wine is kept at too low a temperature, this can result in the development of harmful deposits. A humidity of 70% is ideal for keeping corks from shrinking.
- After a bottle of wine has been opened, the wine comes into contact with air. So it is best to store the remainder of the bottle upright, to minimize the surface area of the wine that is coming into contact with the air.
- Once opened, wine will remain in a drinkable condition for two days for delicate whites or three days for rich reds, as long as the bottle has been resealed. You should make sure that the seal is firm by checking the stopper.
- Special stoppers that keep wine sparkling and Champagne bubbling for one or two days after opening, can be bought at most good wine shops.
- When stored correctly, white wines can keep well for up to two years. Full bodied reds will age well for ten years and dessert wines will age well for up to twenty years.
- When you buy a bottle of wine, you should transfer it to a suitable storage location immediately (if you are not going to store it in your wine cabinet).
- Cheaper bottles of wine will not age as well as more expensive ones.
- To make the most of the bouquet and taste of your wine, never fill more than half a glass at a time. It will also help if the shape of your wine glass is appropriate for your wine. The size and shape of your wine glass's bowl will determine the intensity and complexity of the bouquet. The stem should be long enough to allow you to avoid hand contact with the bowl of the glass and should be tulip-shaped or tapered at the top.

## **Wine storage problems**

***Corking-*** a tiny percentage of bottled wine (about 1%) will suffer from this. The cork reacts with the wine and gives it a musty, unpleasant taste. It is the most common wine storage problem and is caused by harmless bacteria growing on the cork. As unfortunate as this is, there is nothing to do but to discard all of the wine in the affected bottle. This is not to be confused with small fragments of cork floating in the wine itself, which will not impair the flavour.

***Oxidisation-*** when wine has been opened and left for longer than a day; it tends to lose its aroma and colour, giving an overall flat taste. The only way to avoid this, is to either drink the wine on the same day it was opened or to use a vacuum device specially designed for removing oxygen from opened wine bottles. If you use such a device, the wine should still be consumed shortly afterwards.

***Ullage-*** this is loss of wine from the bottle by evaporation or leakage. Signs of ullage include wine seeping around the cork, a protruding cork or a stained label. It can happen if the bottle has been allowed to get too warm. The wine may still be drinkable, if the leakage was recent; however, you should be aware that if the wine cools down again, contraction can cause more air to be sucked into the bottle and result in further deterioration.

***Slight effervescence in still wine-*** this isn't really a problem with the way the wine has been stored, but as a result of incomplete malolactic fermentation before the wine was bottled. A good way to get rid of the effervescence is to let the wine breathe. Alternatively you can use a bottle vacuum device, after about five minutes the effervescence will vanish.

***Sediment-*** this is not normally a problem, however both red and white wines can produce sediment after a number of months in a bottle. The sediment consists of tartrate crystals and is totally harmless. If anything the building of sediment can be considered a good sign because it means that the wine was not subjected to much (if any) filtering, meaning that the flavours and aromas should be preserved better.

A good way to get around sediment (if it is a problem) is to stand the bottle upright, the day before opening, so that the sediment can settle to the bottom of the bottle.

You can also decant your wine; decanting will "open up" the flavour of both young and old wines, but younger wines in particular. To decant, pour the wine slowly and evenly into your decanter.

## Cleaning and maintenance

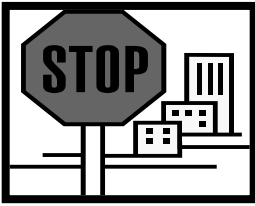

**WARNING: PLEASE ENSURE THAT YOUR APPLIANCE IS DISCONNECTED FROM YOUR MAINS SUPPLY BEFORE ATTEMPTING TO CLEAN IT.**

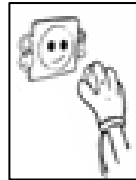

- Do not clean the appliance by pouring water onto it or spraying water over it.



- The interior of the wine cooler should be cleaned periodically, using a solution of bicarbonate of soda and lukewarm water.

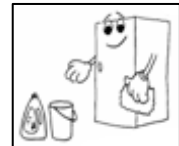

- Clean the accessories separately with soap and water. Do not clean them in a dishwasher.

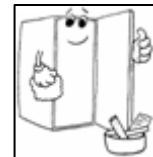

- Do not use abrasive products, detergents or soaps.
- After washing the appliance, wipe over the area that you have cleaned with a damp cloth and then dry it thoroughly.

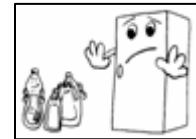

- When cleaning is complete, dry your hands and then reconnect the plug to your mains supply.

### Defrosting

- Defrosting occurs automatically inside of the wine cabinet during operation. The defrost water is collected by the evaporating tray and evaporates automatically.
- The evaporating tray and defrost water drain hole should be cleaned periodically. This will prevent water from collecting in the bottom of the wine cabinet, instead of flowing down the defrost drainage channel and drain hole.
- You can also pour a small amount of water down the drain hole to clean inside of it.
- You should be careful to make sure that wine bottles do not touch the rear wall of the appliance, as this can interrupt the



automatic defrosting process and deflect water into the base of your wine cabinet.

## **Moving your wine cabinet**

If you need to move your wine cabinet to another location you should follow the steps outlined below.

- Remove all items from the wine cabinet.
- Securely tape down all loose items such as the shelves inside of the appliance.
- Turn the adjustable foot up to the base to avoid damage.
- Tape the door closed.
- Ensure the appliance stays secure in the upright position during transportation. Also protect the outside of the appliance with a blanket or similar item.

## **Power failure**

- Most power failures are corrected within a few hours and should not affect the temperature of your appliance if you minimise the number of times the door is opened.
- If the power is going to be off for a longer period of time, you need to take the proper steps to protect the contents.

***IMPORTANT: If the appliance is unplugged, the power is lost or turned off you must wait 5 minutes before restarting the wine cabinet. If you attempt to restart before this time delay, the compressor could be damaged.***

## **Vacation time**

***Short holidays:*** Leave the wine cabinet in operation for holidays of less than 3 weeks.

***Long absences:*** If the appliance will not be used for several months, remove all items, turn off the appliance and unplug the electricity cable. Clean and dry the interior thoroughly. To prevent odour and mould growth, leave the door open slightly by blocking it open if necessary.

## Installation

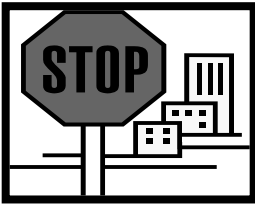

**IMPORTANT: Before installation and usage read all the instructions and make sure that the voltage (V) and the frequency (Hz) indicated on the rating plate are exactly the same as the voltage and frequency in your home. The rating plate can be found on the front left edge of the inside of the wine cabinet.**

The manufacturer declines all responsibility in the event of the installer failing to observe all the accident prevention regulations in force, which are necessary for normal use and the regular operation of the electric system.

### Electrical connection



**YOUR WINE CABINET IS INTENDED FOR FITTED AND PERMANENT INSTALLATION.**

We recommend that the appliance is connected by a qualified electrician, who is a member of the N.I.C.E.I.C. and who will comply with the I.E.E. and local regulations.

- Your wine cabinet comes supplied with a 13 amp plug fitted. If in future you need to change the fuse in this plug, then a 13 amp ASTA approved (BS 1362) fuse **must** be used.
- The wiring in the mains lead is coloured as follows:

<b>Brown</b>	Live
<b>Blue</b>	Neutral
<b>Green and yellow</b>	Earth

- As the colours of the wires in the appliance's mains lead may not correspond with the coloured markings identifying the terminals in your spur box, please proceed as follows:

The **brown wire** must be connected to the terminal marked "L" (live), or coloured **red**.

The **blue wire** must be connected to the terminal marked "N" (neutral), or coloured **black**.

The **green and yellow wire** must be connected to the terminal marked "E" (earth), or by the earth symbol, or coloured **green and yellow**.

- When the connection is completed, no stray strands or cut wire should be present. The cord clamp must be secured over the outer sheath.

## Positioning

- It is advisable that your appliance is only installed in a location where the ambient temperature of the room, corresponds with the climate classification that is stated on the rating plate of your appliance. Your appliance may not function correctly if the ambient temperature falls outside of the following ranges.

<b><i>Climate classification</i></b>	<b><i>Appropriate ambient temperature</i></b>
SN	+10 to +32 degrees centigrade
N	+16 to +32 degrees centigrade
ST	+18 to +38 degrees centigrade
T	+18 to +43 degrees centigrade

- Positioning the appliance requires two people in order to avoid injuries or damage to the appliance.
- Your appliance should not be located in direct sunlight or exposed to continuous heat or extremes of temperature (e.g. next to a radiator or boiler). If this is not feasible, then you should install an insulation plate between the appliance and the adjacent heat source.
- You should check whether there is an electrical socket available, which will be accessible after your appliance is installed.
- Place the appliance flatly and firmly on a solid base.
- Anything positioned above the appliance must be at least 10 cm away to allow sufficient cooling of the condenser. You must allow a 5 cm gap to the rear and either side of the appliance.
- Be sure to leave enough space for the opening of the door, to avoid damage to the appliance or personal injury.
- ***IMPORTANT: The vent at the base of the appliance is for ventilation. Nothing should be placed in front of this vent; otherwise your wine cabinet may not operate properly.***
- The appliance is equipped with adjustable feet, so that the height may be adjusted to level the cabinet on uneven floor surfaces.
- We recommend that two people carry out this procedure.

- Tilt the appliance approximately 60° to allow access to the adjustable feet.
- Take care to ensure the cabinet is supported at all times.
- Twist the foot into a suitable position to level the cabinet.
- Repeat these steps for the other adjustable feet.

***IMPORTANT: If the appliance is not level, then the door and door seal may be affected.***

***IMPORTANT: Do not move the appliance when the feet are adjusted high.***

### Installing the handle

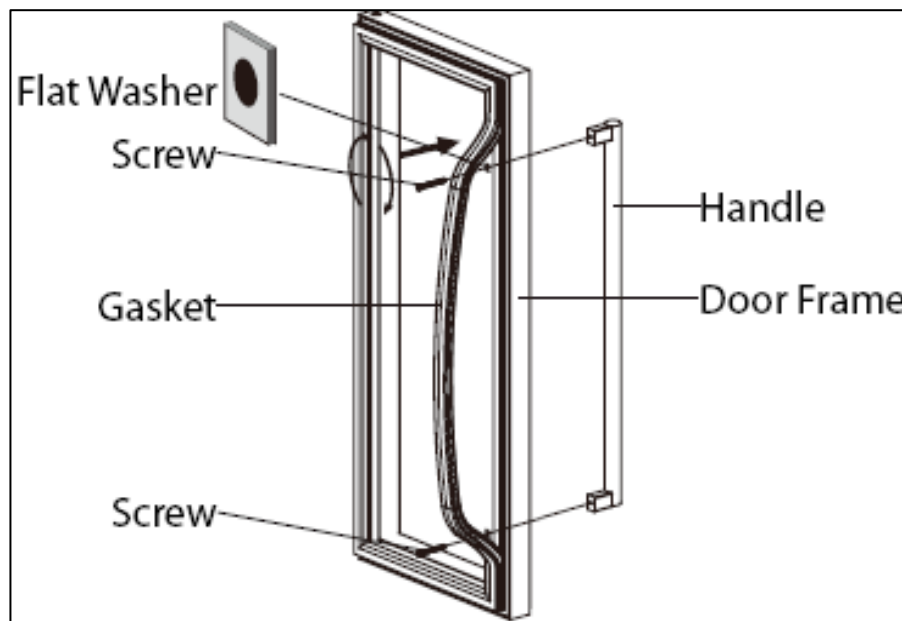

- Remove the door gasket on the inside of the door to expose the two screw holes.
- Install the handle using the screws and washers provided.
- Replace the door gasket.

## Reversing the door of your wine cabinet

*This appliance has the capability of the door opening from either the left or right hand side.*

- The instructions provided below are based on a wine cabinet with a right door hinge installed already.
- 1) Remove the hinge hole cover from the left hand side and the hinge cover from the upper hinge on the right hand side using a screwdriver. Remove the upper hinge by loosening the screws and raising the door.

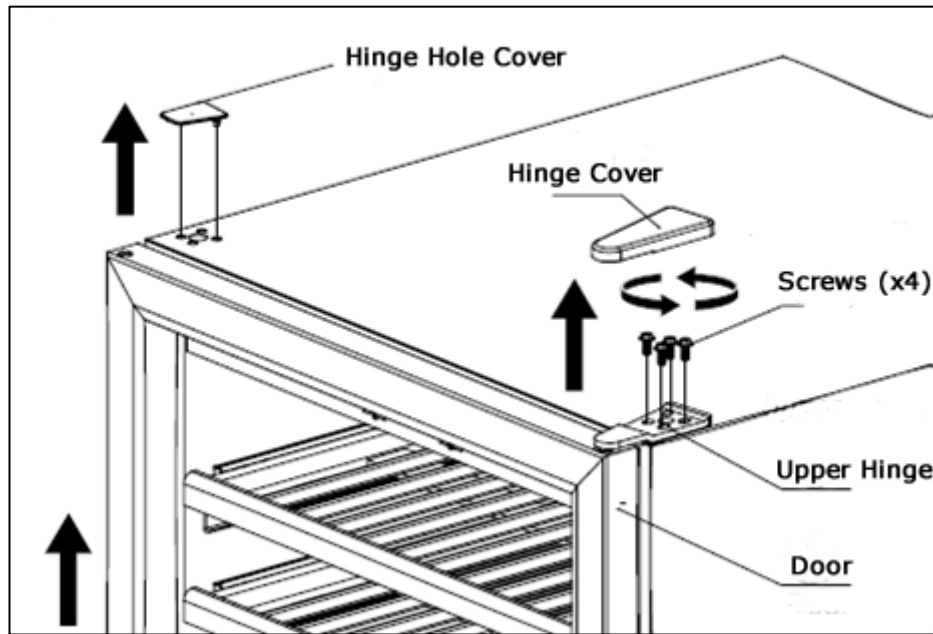

- 2) Unscrew and remove the support rod at the bottom of the door and move it from the right to the left side. Secure it in place by ensuring it is screwed tightly.

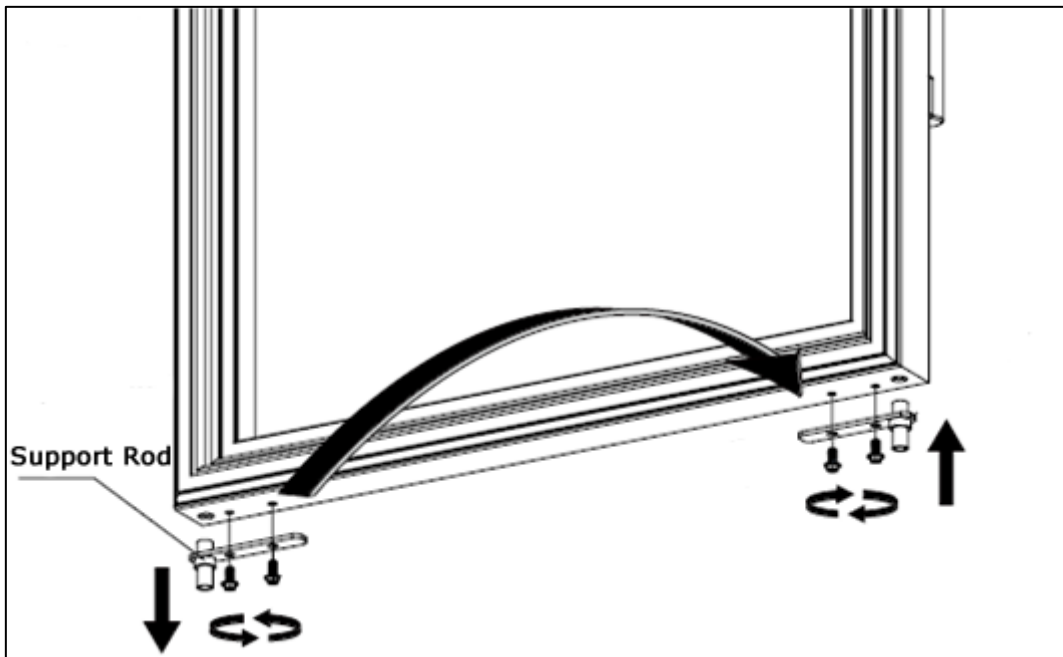

- 3) Move the hinge hole cap at the top of the door from the left to the right hand side.

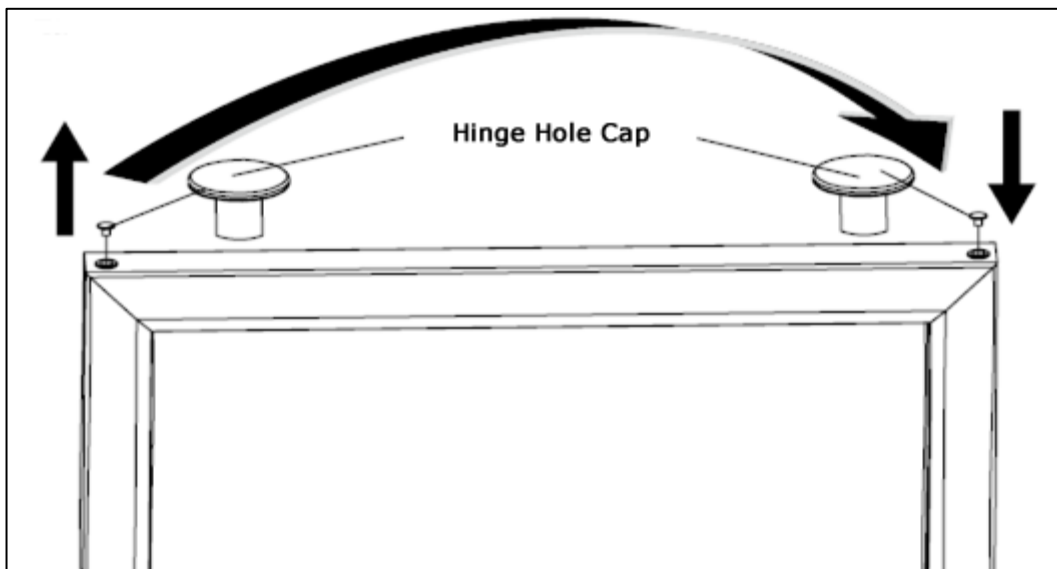

- 4) Remove the bottom hinge cover and take out the bottom hinge by loosening the 4 screws. Remove the screws on the bottom left side. Install the bottom hinge to the left side and replace the screws on the right side.

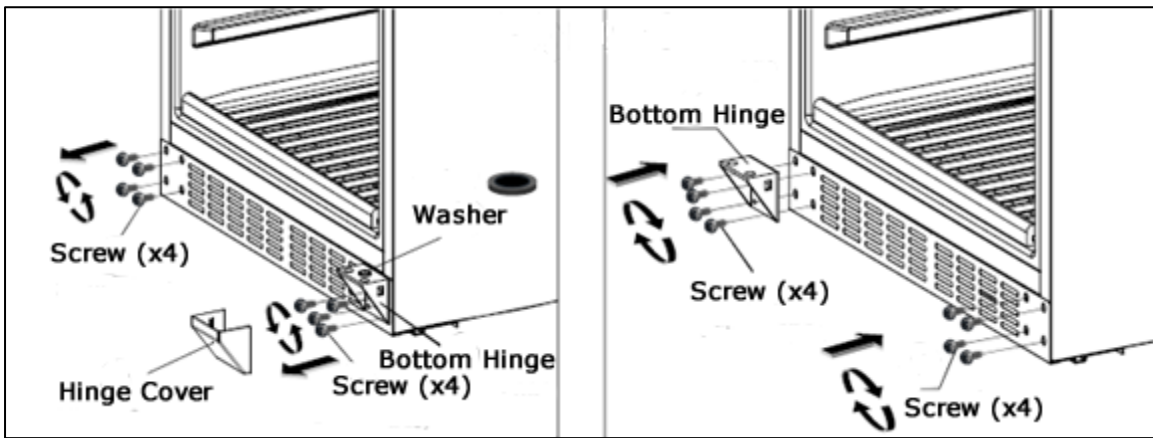

5) To reinstall the door on the opposite side, insert the door support rod into the bottom hinge through the washer and screw the upper hinge to the door. Finally, cover the hinge and hinge holes using the hinge covers.

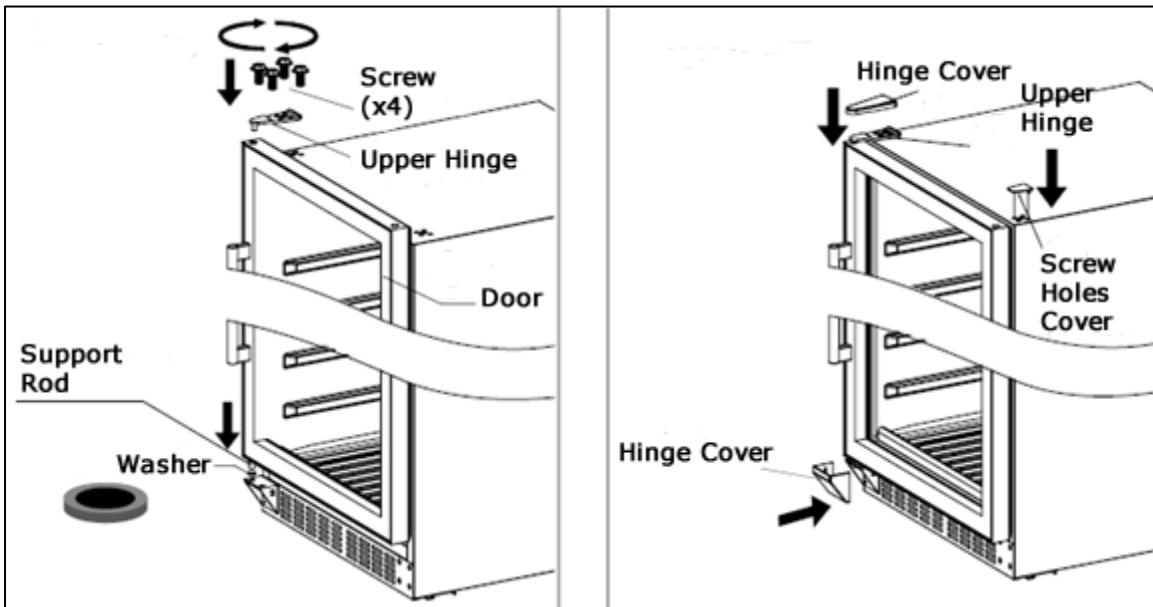

**Any parts that you remove from the appliance whilst reversing the door, should be retained for later use.**

**IMPORTANT:** Check that the door opens and shuts correctly, without fouling, after you have completed the door reversal process.



**After the door has been reversed, you should check the door seal of the wine cabinet. The seal should not be creased or crushed; otherwise there will be a gap between it and the inside of the door.**

- The seal must adhere properly all the way around the door.

- o If the seal is not adhering to the cabinet properly, then you should either: -

a) Use a warm damp cloth and manipulate the seal until it does adhere to the cabinet properly, all the way around the door.

or

b) Use a hair dryer on its lowest heat setting and lightly heat the areas of the door seal that are not adhering correctly. The heat will make the seal more pliable and this will allow you to manipulate the seal into the correct position.

***IMPORTANT: DO NOT HEAT THE DOOR SEAL ON ANYTHING BUT THE LOWEST HEAT SETTING, OR HEAT THE SEAL FOR A LONG PERIOD OF TIME. OTHERWISE DAMAGE MAY BE CAUSED TO THE DOOR SEAL, WHICH WOULD NOT BE RECTIFIED UNDER THE GUARANTEE FREE OF CHARGE.***

***IMPORTANT: WHEN YOU HAVE REVERSED THE DOOR OF THE APPLIANCE, IF YOU HAVE PLACED THE APPLIANCE ON ITS BACK, YOU MUST WAIT FOR 8 HOURS BEFORE SWITCHING THE APPLIANCE BACK ON.***

### Reversing the door handle

- 1) Remove the gasket on the right inner side of the door to expose the 2 decorative screws. Unscrew them in a clockwise direction with a straight screwdriver and then loosen them in an anti-clockwise direction using your fingers from the outer side of the door. The screw holes are now ready for installing the handle to the right hand side.

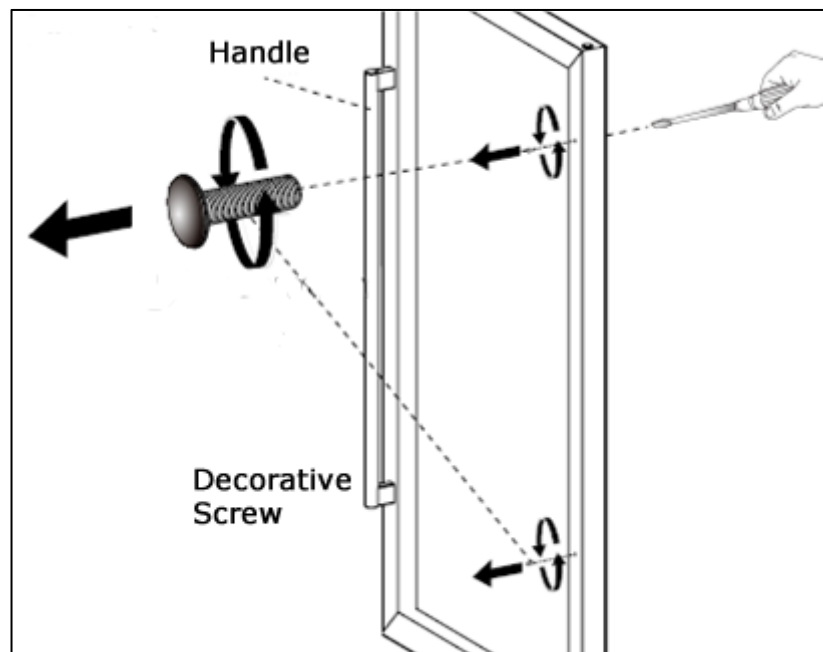



- 2) Remove the gasket on the left inner side of the door to expose the 2 handle screws. Unscrew them in an anti-clockwise direction with a cross screwdriver. Take out the screws and washers as well as the handle.

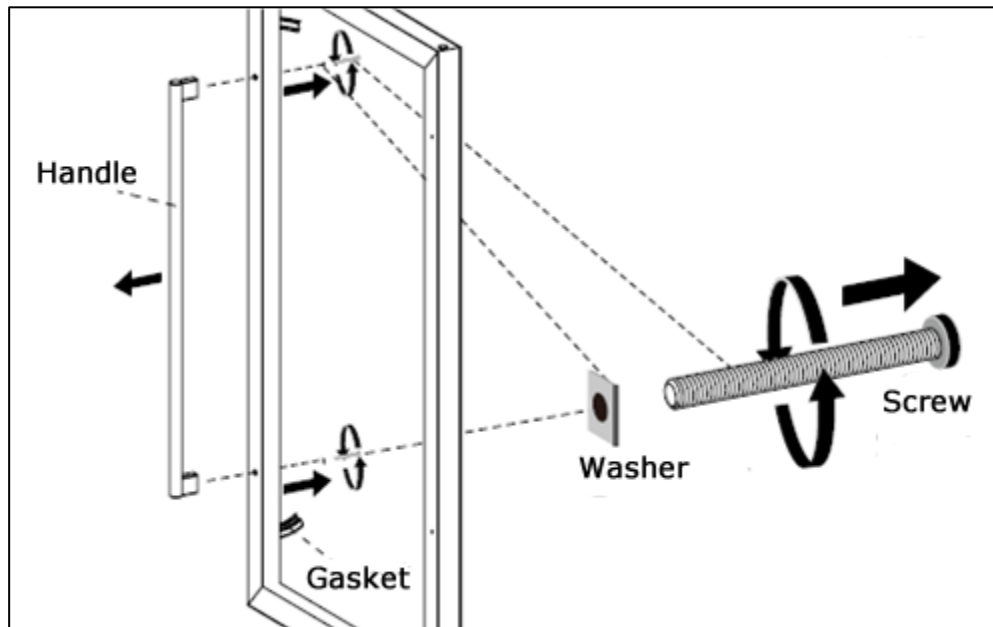

- 3) Install the handle on the outer right side of the door.

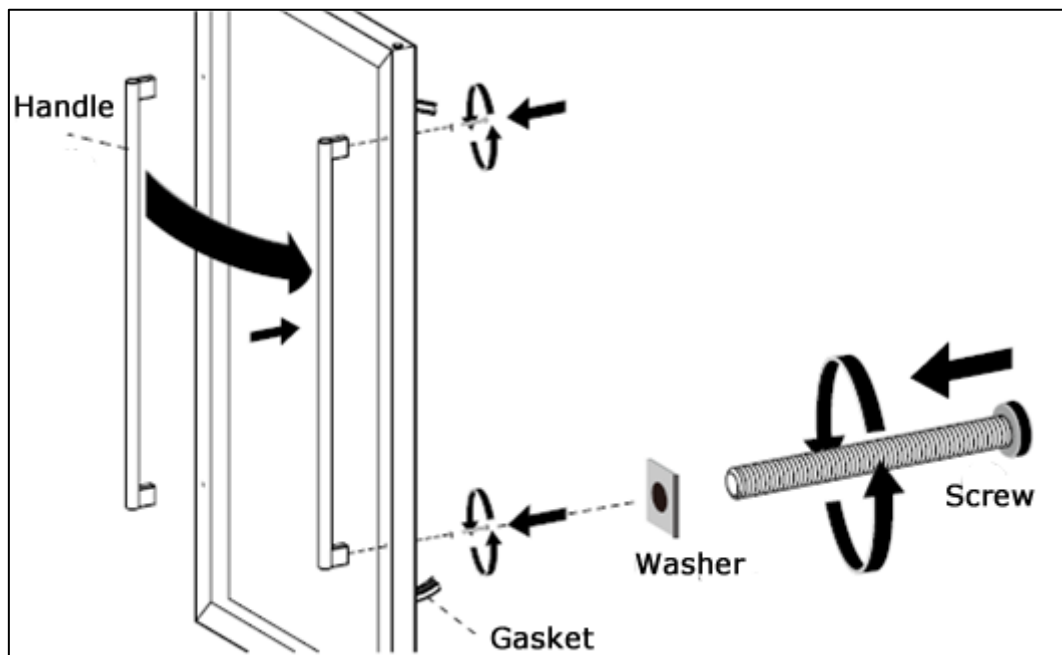

- 4) Install the 2 decorative screws in the holes on the left hand side of the outer door by following the instructions for removing the decorative screws in reverse (step 1).

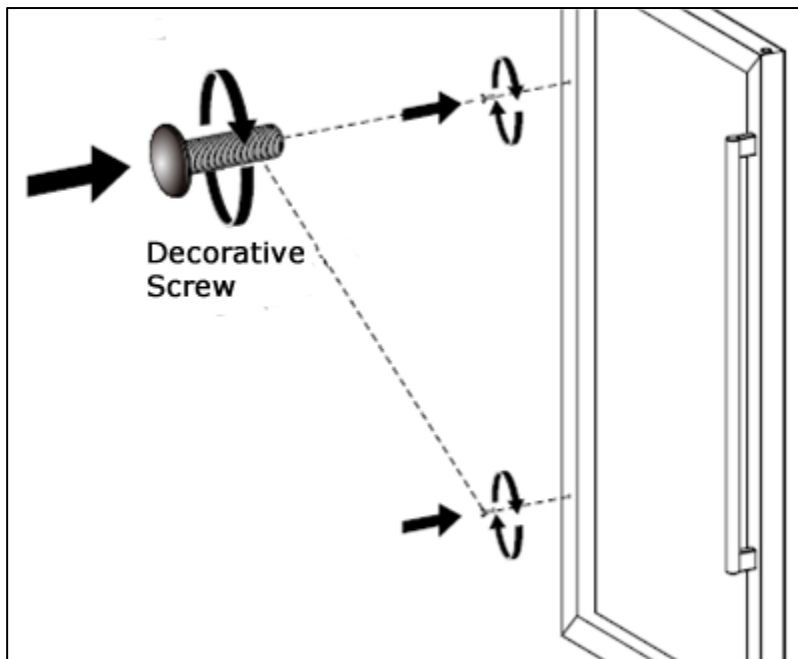

5) Tidy and restore the door gasket.

## Troubleshooting



**IMPORTANT:** *If your wine cabinet appears not to be operating properly, before contacting the Customer Care Department, please refer to the checklist below.*

<b>PROBLEM</b>	<b>POSSIBLE CAUSE</b>
The wine cabinet will not operate.	The appliance is not plugged in. The appliance is turned off. The circuit breaker tripped or a fuse has blown.
The wine cabinet is not cold enough.	Check the temperature setting. The external environment may require a lower temperature setting. The door is opened too frequently. The door is not closed completely. The door gasket does not seal properly.
The appliance automatically turns on and off frequently.	The room temperature is hotter than normal. A large amount of contents have been added to the wine cooler. The door is opened too frequently. The door is not closed completely. The temperature control is not set correctly. The door gasket does not seal properly.
The lighting does not work.	The appliance is not plugged in. The circuit breaker tripped or a fuse has blown. The light is turned off.
Too much vibration.	Check to ensure the appliance is level. Check to ensure that no parts inside of

	the cabinet or in the compressor chamber are loose.
The wine cabinet seems to make too much noise.	The rattling noise may come from the flow of the refrigerant which is normal. As each cycle ends, you may hear gurgling noises caused by the flow of refrigerant. Contraction and expansion of the inside walls may cause popping and crackling noises. The appliance is not level.
The door will not close properly.	The appliance is not level. The door was reversed and not properly installed. The door gasket is dirty. The shelves are out of position.
"HH" or "LL" appear on the display and a continuous buzz noise can be heard.	The temperature probe is out of order. When this happens, the appliance is designed to keep periodical running of the compressor and fan to help maintain the coldness inside the cabinet to protect your wines. To avoid ruining your wines it is strongly recommended to have the appliance repaired immediately as the spare periodical running can not ensure the appliance will achieve the temperature you have set.



***IMPORTANT: If your appliance appears not to be operating correctly, then you should disconnect it from your mains supply and then contact the Customer Care Department on telephone number (0118) 933 6911.***

***DO NOT ATTEMPT TO REPAIR THE APPLIANCE YOURSELF.***

Please note that if an engineer is asked to attend whilst the product is under guarantee and finds that the problem is not the result of an appliance fault, then you may be liable for the cost of the call out charge.

***The appliance must be accessible for the engineer to perform any necessary repair. If your appliance is installed in such a way that an engineer is concerned that damage will be caused to the appliance or your kitchen, then he will not complete a repair.***

***This includes situations where appliances have been tiled in, sealed in with sealant, have wooden obstructions placed in front of the appliance, like plinths. Or any installation other than the one specified by Baumatic Ltd. has been completed.***

Please refer to the conditions of guarantee that appear on the warranty card that you receive with the appliance.

***IMPORTANT: Baumatic Ltd. operates a policy of continuous improvement and reserves the right to adjust and modify its products without prior notification.***

## **Baumatic consumables**

- **BC001** Degreaser for Dishwashers (200g)
- **BC002** Descaler for Washing Machines and Dishwashers (200g)
- **BC003** Ceramic Hob Cleaner (250ml)
- **BC004** Oven Cleaner (250ml)
- **BC005** Stainless Steel Cleaner and Protector (250ml)
- **BC007** E-Cloth – General Purpose Cloth
- **BC008** Microwave Cover

To order a Baumatic consumable product please call 0123 5437 244 and quote the product code. You can also order online from [eshop.baumatic.co.uk](http://eshop.baumatic.co.uk)

## Technical Data

Manufacturer	BAUMATIC
Model Number	BWC1215SS
Product Category	2 – Refrigeration-cellar, Cellar and wine storage appliances
Energy Efficiency Class <b>(1)</b>	D
Annual Energy Consumption <b>(2)</b>	314 kWh
Storage Volume of Fridge Compartment	266 litres
Storage Volume of Freezer Compartment	N/A
Star Rating	N/A
Coldest Storage Temperature	Upper Zone: 5°C / Lower Zone: 12°C
Frost Free Compartments	N/A
Temperature Rise Time	N/A
Freezing Capacity	N/A
Climate Class <b>(3)</b>	N
Noise Level	40 dB
Installation Type	Freestanding

This appliance is intended to be used exclusively for the storage of wine.

**(1)** On a scale from A+++ (highest efficiency) to G (lowest efficiency).

**(2)** Annual energy consumption based on standard test results for 24 hours. The actual energy consumption will depend on how the appliance is used and where it is located.

**(3)** This appliance is intended to be used at an ambient temperature between "16°C" (lowest temperature) and "32°C" (highest temperature).



***United Kingdom***

Baumatic Ltd.,  
Baumatic Buildings,  
6 Bennet Road,  
Reading, Berkshire  
RG2 0QX  
United Kingdom

**Sales Telephone**

(0118) 933 6900

**Sales Fax**

(0118) 931 0035

**Customer Care Telephone**

(0118) 933 6911

**Customer Care Fax**

(0118) 986 9124

**Spares Telephone**

(01235) 437244

**Advice Line Telephone**

(0118) 933 6933

**E-mail:**

sales@baumatic.co.uk  
customercare@baumatic.co.uk  
spares@baumatic.co.uk  
technical@baumatic.co.uk

**Website:**

www.baumatic.co.uk

**Facebook:**

[www.facebook.com/baumatic.uk](http://www.facebook.com/baumatic.uk)

***Republic of Ireland***

**Service Telephone**

1-890 812 724

**Spares Telephone**

091 756 771

***Czech Republic***

Baumatic CR s.r.o.  
Lípová 665  
460 01 Liberec 4  
Czech Republic

+420 483 577 200

www.baumatic.cz

***Slovakia***

Baumatic Slovakia, s.r.o.  
Galvániho 7/D  
Slovakia

+421 255 640 618

***Germany***

Baumatic Gmbh  
Bachstr.10-12  
D-32257 Bünde  
Germany

+49 (0) 5223 99408 0

www.baumatic.de

***Italy***

Baumatic Italia S.R.L.  
Via Galvani N.3  
35011 Campodarsego (PD)

+3904 9920 2297

www.baumatic.it

***Holland***

Baumatic Benelux B.V.  
Dukdalfweg 15d  
1332 BH ALMERE  
Nederland

+3136 549 1555

www.baumatic.nl

