



You're home.™

2 year  
guarantee

# Performance 12

Let's get started



C86-PB-(Be, Pe, Te)

[vax.co.uk](http://vax.co.uk)



## Basic safety precautions

**This vacuum cleaner is intended for household use only and NOT for commercial or industrial use.**

- Only use the vacuum cleaner indoors on dry surfaces and keep the area you're cleaning well lit.
- Keep fingers, hair and loose clothing away from moving parts and openings whilst using the vacuum cleaner.
- This vacuum cleaner can be used by children aged from 8 years and above and persons with reduced physical, sensory or mental

capabilities or lack of experience and knowledge if they have been given supervision or instruction concerning use of the vacuum cleaner in a safe way and understand the hazards involved. Children shall not play with the vacuum cleaner. Cleaning and user maintenance shall not be made by children without supervision.

- Only Vax recommended tools and accessories should be used with this vacuum cleaner.

**Please keep instructions for further use.**



## Don'ts

- ✗ Don't vacuum up hot coals, cigarette butts, matches or smoking hot burning items or use in an area where there may be harmful fluids (chlorine, bleach, and ammonia drain cleaner).
- ✗ Don't attempt to remove blockages with sharp objects as this may cause damage to the vacuum cleaner.
- ✗ Don't vacuum up hard or sharp objects such as glass, nails, screws or coins etc.
- ✗ Don't use the vacuum cleaner with incorrect voltage as this may result in damage or injury to the user. The correct voltage is listed on the ratings label.



## Do's

- ✓ Turn off all controls on the vacuum cleaner before disconnecting or connecting the power cord.
- ✓ Always make sure the filters are in place before use.
- ✓ Always switch off the vacuum cleaner before disconnecting or connecting the hose and accessories.
- ✓ Keep all openings clear and free from debris as this may affect the airflow/suction.
- ✓ Always replace the fuse in the plug with a British 13amp fuse. Always protect the power cable from heated surfaces and open flames.
- ✓ Take extra care when positioning and using the vacuum cleaner on the stairs.
- ✓ Use only CE approved 13amp extension cords, non-approved extension cords may overheat. Care should be taken to arrange the extension cord as it can be a trip hazard.
- ✓ Store the vacuum cleaner in a cool, dry area. If filters have been cleaned as per user guide instructions ensure they are thoroughly dry before storing away.



## Don'ts

- ✗ Don't use the vacuum cleaner if it has been dropped, damaged or left outdoors.
- ✗ Don't run over the power cord or use vacuum cleaner if the power cord or plug is damaged. Please contact our Customer Care Line on: 0844 4128 455 (Mon-Fri 8.30am to 6.30pm Sat 9.00am to 5.00pm).
- ✗ Don't handle the plug or use the vacuum cleaner with wet hands.
- ✗ Don't pull or carry the vacuum cleaner by the power cord. Don't use the power cord as a handle, pull the power cord around corners, sharp edges or close a door over the power cord. Don't unplug vacuum cleaner by pulling on the power cord.
- ✗ Don't vacuum up any flammable or combustible materials (lighter fluid, petrol, kerosene etc.) or use the vacuum cleaner in an area with explosive vapours or liquid.

# Thank you for buying this Performance 12.

## Taking care of your carpets

The Performance 12 is designed to make vacuuming carpets regularly, as effective and efficient as possible and this user guide will help you get the most out of your machine.

Maintaining your carpets will ensure they keep their appearance for longer and smell fresh and clean. You've chosen carpets for your home for a reason and Vax will help you take good care of them.

## Taking care of your Performance 12

Also inside this guide are instructions on maintaining your new machine, so that it's always ready when you are to tackle your carpets.

## Taking care of you

We're here if you need us. Instead of taking me back to the shop, simply visit:

[vax.co.uk/support](http://vax.co.uk/support) or call:

(UK) **0844 412 8455** (ROI) 1-800 928 308

Monday-Friday 8.30am to 6.30pm, Saturday 9.00am to 5.00pm

Calls are charged at the UK local rate. Please make a note of the serial number and model number of the product before calling.

Alternatively, you can write to us at:

Vax Ltd., Kingswood Road, Hampton Lovett, Droitwich, Worcestershire, WR9 0QH, UK



Let us know what you think @VaxUK



You're home.™

## Contents

- Let's talk safety
- Getting to know your machine
- Getting started
- Using your machine
- Taking care of your machine
- Let's talk technical
- What to do if it goes wrong
- Getting in touch
- Accessories
- Notes

### Initial Setup for normal operation

- Use the base accessories.
  - Shortest hose
  - Extension tube set to shortest practicable length.
- Clean filters installed.
- Dust receptacle empty.
- All Bleeds must be closed.
- Variable Power set to Maximum.
- Floor heads/tools set to Carpet Mode for carpet cleaning.
- Mechanical Agitation turned ON for carpet cleaning.
- Floor heads/tools set to Hard Floor Mode for hard floor cleaning.
- Mechanical Agitation turned OFF for hard floor cleaning.

## Performance 12

### Included with your machine\*

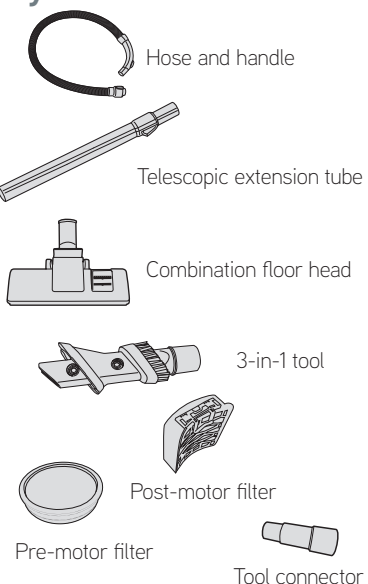

## Performance 12 Pet



## Performance 12 Total Home

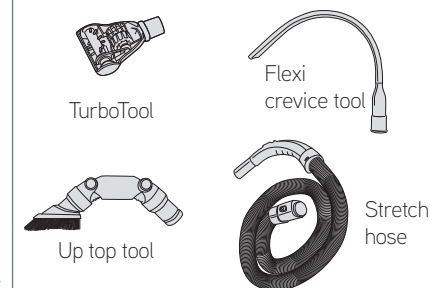

\* Some parts may vary according to model. Please check inside of box for more details.

**PLEASE READ 'LET'S TALK SAFETY' AT THE BEGINNING BEFORE USE**

## Before you begin cleaning

**IMPORTANT:** The vacuum cleaner is equipped with a thermal cut-out. If for any reason the vacuum cleaner does overheat, the thermostat will automatically turn the vacuum cleaner off. If this happens, switch the vacuum cleaner off and unplug. Remove and empty the dirt container also check the vacuum cleaner for blockages. Allow the vacuum cleaner to cool for approximately 1 hour (if you have cleaned the filters please wait 24 hours for the filters to fully dry before putting back into the machine).

Clean the pre-motor every time the dirt container is emptied and replace the filters every 12 months.

If the vacuum cleaner is blocked, switch off and unplug before removing the blockage.

## Assembling your vacuum cleaner

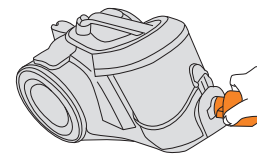

Press both buttons at end of hose and insert into hose entry point.

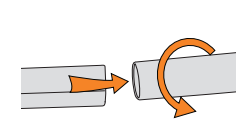

Insert hose grip into telescopic extension tube.

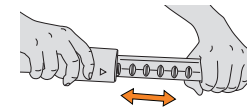

Press button on telescopic extension tube and adjust to required length.

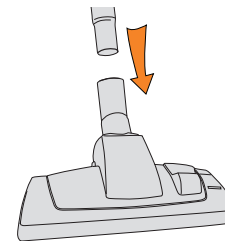

Insert the other end of the telescopic tube into the floor head.



## WARNING

Always switch off the vacuum cleaner before connecting or disconnecting the hose/attachments, or removing and emptying the dirt container.

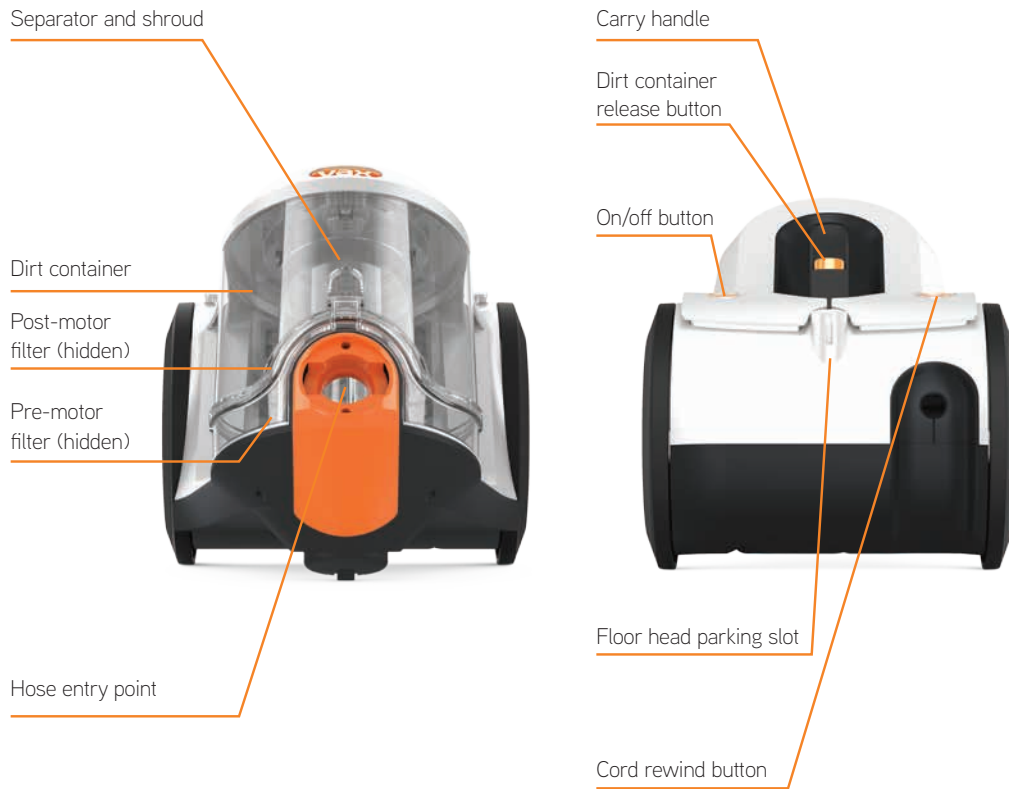

Separator and shroud

Dirt container

Post-motor filter (hidden)

Pre-motor filter (hidden)

Hose entry point

Carry handle

Dirt container release button

On/off button

Floor head parking slot

Cord rewind button

## Technical Specification

Name **Performance 12**  
Voltage **220-240~50Hz**  
Wattage **800watts**  
Cord Length **5.5/6m**  
Weight **5kg**

Subject to technical change without notice.

## Accessories & Consumables

Turbo Tool (Type 6) <b>1-1-134419-00</b>	3-in-1 tool (Type 9) <b>1-1-134551-00</b>
Tool Connector (Type 1) <b>1-1-133838-00</b>	Filter (Type 108) – Post Filter <b>1-1-134392-00</b>
Combination Floor Tool (Type 6) <b>1-1-134330-00</b>	Filter (Type 116) – Pre Filter <b>1-1-134532-00</b>

\*To purchase consumables and accessories, please visit [vax.co.uk](http://vax.co.uk)

## Using your machine

**IMPORTANT:** The base of the vacuum cleaner should always be positioned flat on the floor when starting and in use. The dirt container should be locked into place before lifting the vacuum cleaner by the carry handle.

**WARNING:** When unwinding the power cord do not pull further than the yellow marker.

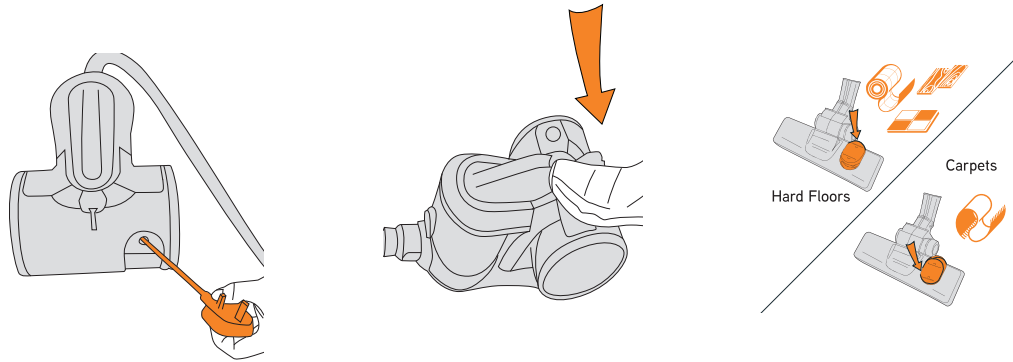

Unwind the power cord. Do not pull further than the yellow marker.

Plug into mains and push the on/off button to turn the machine on.

For use on carpets, click rocker switch forward. For use on hard floors click rocker switch back.

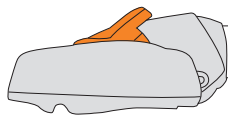

Raise brushes for carpets.

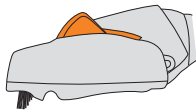

Lower brushes for hard floors.

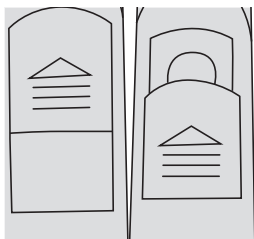

Slide vent cover on hose grip open to reduce suction if required.

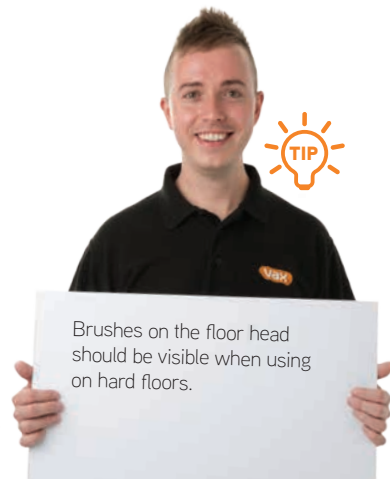

Brushes on the floor head should be visible when using on hard floors.

## Using your machine

### Using accessories

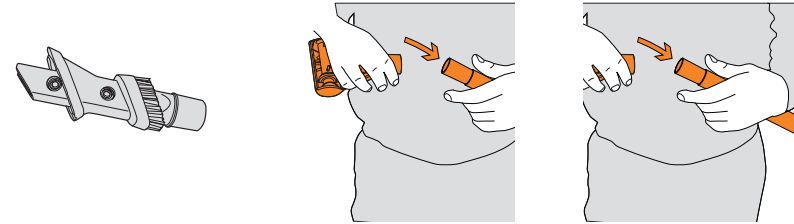

Choose an accessory.

Attach accessory to hose end. If required use tool connector.

## Taking care of your machine

**IMPORTANT:** Unplug and switch off vacuum cleaner before performing maintenance or troubleshooting checks.

### Emptying and cleaning the dirt container

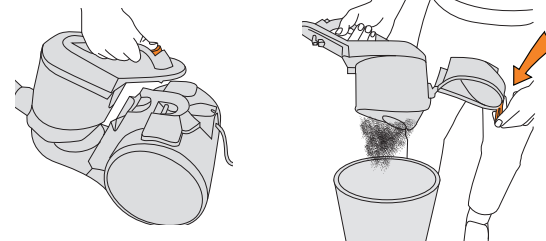

Press dirt container release button and lift to remove.

Hold dirt container over a bin and pull the dirt release clip on the bottom of the dirt container, allowing dirt/debris to fall out.



Don't over fill the dirt container to avoid blocking the air flow through the vacuum cleaner.

### Cleaning the shroud

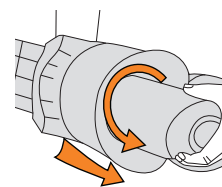

Twist the shroud and pull to remove.

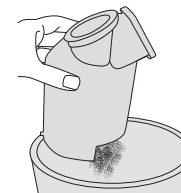

Tap the shroud over a bin to remove any dirt/debris.

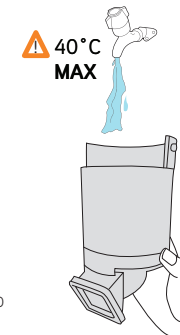

Rinse the shroud under water (Max 40°C) Leave to dry for 24 hours or until fully dry before placing back in the machine.

## Taking care of your machine

### Cleaning the pre-motor filter

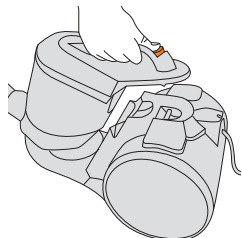

Press dirt container release button and lift to remove.

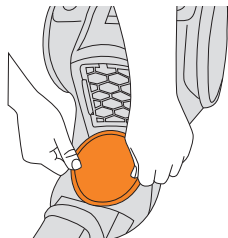

Remove the pre-motor filter. Separate the filter frame and foam.

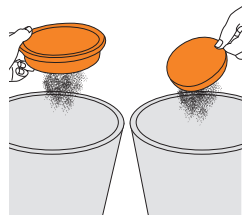

Tap the filter frame and foam over a bin to remove any dirt/debris.

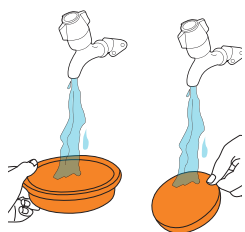

Rinse both the filter frame and foam under water (Max 40°C).

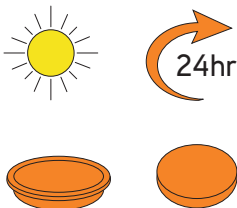

Leave to dry for 24 hours or until fully dry before placing back in the machine.

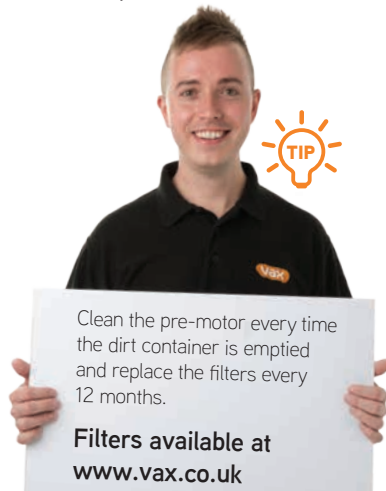

### Cleaning the post-motor filter

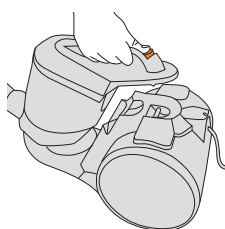

Press dirt container release button and lift to remove.

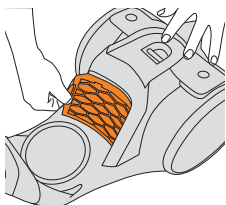

Push tab and pull to remove the post-motor filter.

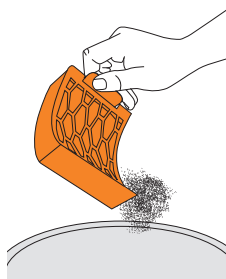

Tap the post-motor filter over a bin to release dirt/debris. Always replace before using your vacuum.



**WARNING**

Do not wash the post-motor filter.

## Taking care of your machine

### Storing your vacuum cleaner

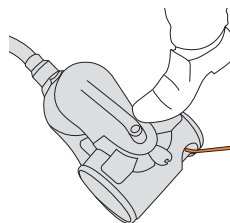

Once the vacuum cleaner is unplugged, press the cord rewind button to retract the cord.

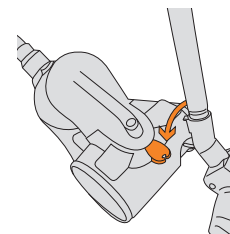

Place floor head into parking slot located at back of vacuum cleaner for storage and carrying.

## Let's talk technical

**IMPORTANT:** Remove accessory from hose or telescopic extension tube before performing maintenance or trouble shooting checks.

### Removing blockages from the TurboTool\*

1

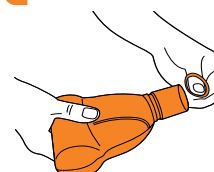

Slide the locking ring to remove.

2



Lift and separate the housing.

3



Using a pair of scissors, remove any threads or hair caught around the brushbar.

4

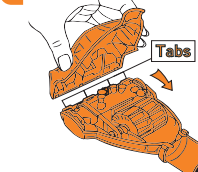

Line up the tabs on front of housing and push together to refit. Slide locking ring into groove to secure.

\*Not applicable for all models.

### Removing a blockage from the hose

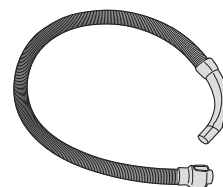

Remove the hose from the vacuum cleaner and telescopic extension tube. Remove any blockage by inserting wire coat hanger in to hose.



To test for a blockage in hose, drop a small ball of paper into the hose. The paper will drop through if the hose is clear.

## Problem

## Solution

Is there an accessory missing?

- Check the 'This pack contains' panel on the box to make sure the part is included with your vacuum cleaner.

Why won't the vacuum cleaner pick up?

- The dirt container may not be correctly fitted, remove the dirt container from the vacuum cleaner and check it's assembled correctly, refit ensuring it's locked into place.
- The shroud is blocked or not correctly fitted. Go to 'Taking care of your machine'.
- The filter may be clogged, clean the filter. Go to 'Taking care of your machine'.
- The dirt container may be blocked, empty the dirt container. Go to 'Taking care of your machine'.
- There may be a blockage in the hose/tube. Disconnect from the vacuum cleaner and carefully remove any blockages. Go to 'Let's talk technical'.

Why does my vacuum cleaner have no power?

- The plug may not be fully pushed into the electrical socket.
- Check the fuse in the plug if this needs replacing, always replace with a 13amp fuse.
- The motor thermostat may have tripped. If this has happened, unplug the vacuum cleaner. Remove and empty the dirt container and check the hose for blockages. Clean the filters and allow the vacuum cleaner to cool for approximately 1 hour (if you have washed the filters you will need to wait 24 hours for the filters to fully dry before putting them back into the vacuum cleaner).

Why is dust escaping from the vacuum?

- The filters may be clogged, clean the filter. Go to 'Taking care of your machine'.

**Warning:** To reduce the risk of personal injury, unplug the vacuum cleaner before performing maintenance /troubleshooting checks.



\* Calls are charged at the UK local rate. Please make a note of the serial number and model number of the product before calling.

# Don't forget your accessories!

Order at: [www.vax.co.uk/spares-and-solutions](http://www.vax.co.uk/spares-and-solutions)

## Pro cleaning kit (Type 2)

1-1-133326-00

All our best tools all in one kit that makes cleaning your home quicker, easier and with even better results. We've taken care of cleaning all of the hard to reach areas such as on top of cupboards and in between blinds to the dust that collates behind and within the radiator.



## TurboTool (Type 6)

1-1-134419-00

Use the TurboTool for vacuuming your stairs, upholstery and car interiors. It's great for picking up stubborn pet hair.



## Fur 'n' Fluff Tool

1-1-131392-00

Specifically designed to remove extra stubborn pet hair from upholstery, furniture and carpets.







You're home.™



@VaxUK

Vax Ltd., Kingswood Road, Hampton Lovett, Droitwich, Worcestershire, WR9 0QH, UK  
email: [info@vax.co.uk](mailto:info@vax.co.uk) website: [vax.co.uk](http://vax.co.uk)

Version 1.0



**EEC Statement of Compliance:** Manufacturer/EEC importer: Vax Limited, hereby on our own responsibility, declare that the C86-PB-(Be, Pe, Te) is manufactured in compliance with the following Directives:

**Safety:** 2006/95/EC Low Voltage Directive. **EMC:** 2004/108/EC Electromagnetic Compatibility Directive.



Waste electrical products should not be disposed of with household waste. Please recycle where facilities exist. Check with your Local Authority or retailer for recycling advice.