

EN

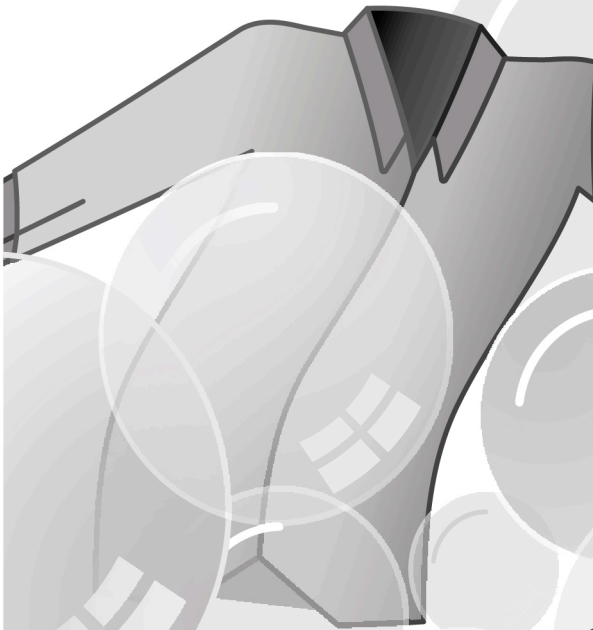
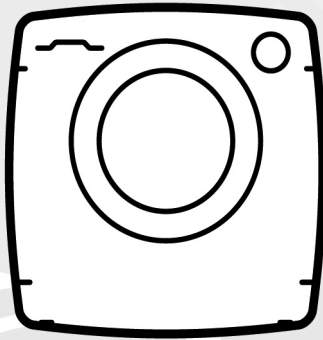

CANDY

C A N D O

Thank-you for choosing a Candy washing machine. We are confident it will loyally assist you in safely washing your clothes, even delicates, day after day.

You can register your product at [www.registercandy.com](http://www.registercandy.com) to gain faster access to supplementary services solely reserved to our most loyal customers.

Carefully read this manual for correct and safe appliance use and for helpful tips on efficient maintenance.



Only use the washing machine after carefully reading these instructions. We recommend you always keep this manual on hand and in good conditions for any future owners.

Please check that the appliance is delivered with this instruction manual, warranty certificate, service centre address and energy efficiency label. Also check that plugs, curve for drain hose and liquid detergent or bleach tray (only on some models) are included. We recommend you keep all these components.

Each product is identified by a unique 16-character code, also called the “serial number”, printed on the sticker affixed to the appliance (porthole area) or in the document envelope found inside the product. This code is a sort of specific product ID card that you will need to register it and should you need to contact the **Candy** Customer Service Centre.

## Environmental conditions



This appliance is marked according to the European directive 2002/96/EC on Waste Electrical and Electronic Equipment (WEEE).

By ensuring this product is disposed of correctly, you will help prevent potential negative consequences for the environment and human health, which could otherwise be caused by inappropriate waste handling of this product.

The symbol on the product indicates that this product may not be treated as household waste. Instead it shall be handed over to the applicable collection point for the recycling of electrical and electronic equipment.

Disposal must be carried out in accordance with local environmental regulations for waste disposal.

For more detailed information about treatment, recovery and recycling of this product, please contact your local city office, your household waste disposal service or the shop where you purchased the product.

## Contents

- 1. GENERAL SAFETY RULES**
- 2. INSTALLATION**
- 3. PRACTICAL TIPS**
- 4. MAINTENANCE AND CLEANING**
- 5. QUICK USER GUIDE**
- 6. CONTROLS AND PROGRAMS**
- 7. DRYING CYCLE**
- 8. AUTOMATIC WASHING/DRYING CYCLE**
- 9. CUSTOMER SERVICE CENTRE AND WARRANTY**

# 1. GENERAL SAFETY RULES

- This appliances is intended to be used in household and similar applications such as:

- Staff kitchen areas in shops, offices and other working environments;
- Farm houses;
- By clients in hotels, motels and other residential type environments;
- Bed and breakfast type environments.

A different use of this appliance from household environment or from typical housekeeping functions, as commercial use by expert or trained users, is excluded even in the above applications. If the appliance is used in a manner inconsistent with this it may reduce the life of the appliance and may void the manufacturer's warranty. Any damage to the appliance or other damage or loss arising through use that is not consistent with domestic or household use (even if located in a domestic or household environment) shall not be accepted by the manufacturer to the fullest extent permitted by law.

- This appliance can be used by children aged from 8 years and above and persons with reduced physical, sensory or mental capabilities or lack of experience and knowledge if they have been given supervision or instruction concerning use of the appliance in a safe way and understand the hazards involved.

Children shall not play with the appliance. Cleaning and user maintenance shall not be made by children without supervision.

- Children should be supervised to ensure that they do not play with the appliance.
- Children of less than 3 years should be kept away unless continuously supervised.
- If the supply cord is damaged, it must be replaced by the manufacturer, its service agent or similarly qualified persons in order to avoid a hazard.
- Only use the hose-sets supplied with the appliance for the water supply connection (do not reuse old hose-sets).
- Water pressure must be between 0,05 MPa and 0,8 MPa.
- Make sure that a carpet do not obstruct the base of the machine and ventilation openings.
- The OFF condition is reached by placing the reference mark on the programmes control/knob in the vertical position. Any other different position of such control sets the machine in ON condition.
- The final part of a washer dryer cycle occurs without heat (cool down cycle) to ensure that the items are left at a temperature that ensures that the items will not be damaged.



## **WARNING:**

**never stop a washer dryer before the end of the drying cycle unless all items are quickly removed and spread out so that the heat is dissipated.**

- After installation, the appliance must be positioned so that the plug is accessible.
- The appliance must not be installed behind a lockable door, a sliding door or a door with a hinge on the opposite side to that of the washer dryer, in such way that a full opening of the washer dryer door is restricted.
- The maximum load capacity of dry clothes depends on the model used (see control panel).
- The appliance is not to be used if industrial chemicals have been used for cleaning.
- Do not dry unwashed items in the washer dryer.
- Items that have been soiled with substances such as cooking oil, acetone, alcohol, petrol, kerosene, spot removers, turpentine, waxes and wax removers should be washed in hot water with an extra amount of detergent before being dried in the washer dryer.
- Items such as foam rubber (latex foam), shower caps, waterproof textiles, rubber backed articles and clothes or pillows fitted with foam rubber pads should not be dried in the washer dryer.
- Fabric softeners, or similar products, should be used as specified by the fabric softener instructions.
- Oil-affected items can ignite spontaneously, especially when exposed to heat sources such as a washer dryer. The items become warm, causing an oxidation reaction in the oil. Oxidation creates heat. If the heat cannot escape, items can become hot enough to catch fire. Piling, stacking or storing oil-affected items can prevent heat from escaping and so create a fire hazard.
- If it is unavoidable that fabrics contain vegetable or cooking oil or have been contaminated by hair care products be placed in a washer dryer they should first be washed in hot water with extra detergent - this will reduce, but not eliminate, the hazard.
- Remove all objects from pockets such as lighters and matches.
- To consult the product fiche please refer to the manufacturer website.

## **Safety instructions**

- Before cleaning or maintaining the washing machine, unplug the appliance and turn off the water faucet.

- Make sure the electrical system is grounded. Otherwise, seek qualified professional assistance.
- Please do not use converters, multiple sockets or extension cords.



**WARNING:**  
water may reach very high temperatures during the wash cycle.

- Make sure there is no water in the drum before opening the porthole.
- Do not pull on the power cord or appliance to unplug the machine.
- Do not expose the washing machine to rain, direct sunlight or other weather elements.

- When moving, do not lift the washing machine by the knobs or detergent drawer; during transport, never rest the porthole on the trolley. We recommend two people lift the washing machine.

- In the event of fault and/or malfunction, turn off the washing machine, close the water faucet and do not tamper with the appliance.

Immediately contact the Customer Service Centre and only use original spare parts. Failure to observe these instruction may jeopardise appliance safety.

- CE Appliance complies with European Directives:**
- 2006/95/EC (LVD);
  - 2004/108/EC (EMC);
  - 2009/125/EC (ErP);
  - 2011/65/EU (RoHS) and subsequent amendments.

## 2. INSTALLATION

- Cut the tube straps, being careful not to damage the tube and power cord.
- Unscrew the **2** or **4** screws (**A**) on the back and remove the **2** or **4** shims (**B**) as illustrated in **figure 1**.
- Close the **2** or **4** holes using the plugs included in the instruction envelope.
- If the washing machine is **built-in**, after cutting the hose straps, unscrew the **3** or **4** screws (**A**) and remove the **3** or **4** shims (**B**).
- In some models, **1** or **more** shims will fall inside the machine: tilt the washing machine forward to remove them. Close the holes using the plugs found in the envelope.



**WARNING:**  
keep packaging materials away from children.

- Place the polionda sheet on the bottom as shown in **figure 2** (according to the model, consider version **A**, **B** or **C**).

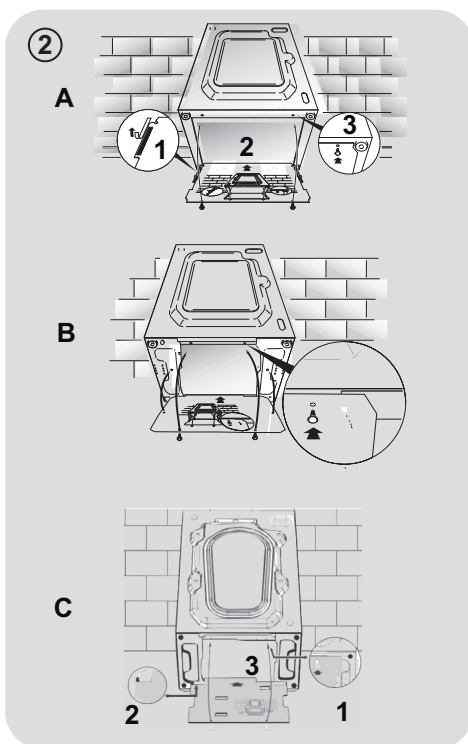
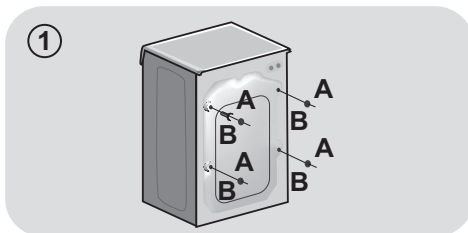

## Hydraulic connections

- Connect the water tube to the faucet, only using the drain tube supplied with the washing machine (fig. 3).

### DO NOT OPEN THE FAUCET.

- Some models may include one or more of the following features:

#### ● HOT&COLD (fig. 4):

water mains connection settings with hot and cold water for higher energy savings. Connect the grey tube to the cold water faucet  and the red one to the hot water faucet. The machine can be connected to the cold water faucet only: in this case, some programs may start a few minutes later.

#### ● AQUASTOP (fig. 5):

a device located on the supply tube that stops water flow if the tube deteriorates; in this case, a red mark will appear in the window "A" and the tube must be replaced. To unscrew the nut, press the one-way lock device "B".

#### ● AQUAPROTECT – SUPPLY TUBE WITH GUARD (fig. 6):

Should water leak from the primary internal tube "A", the transparent containment sheath "B" will contain water to permit the washing cycle to complete. At the end of the cycle, contact the Customer Service Centre to replace the supply tube.

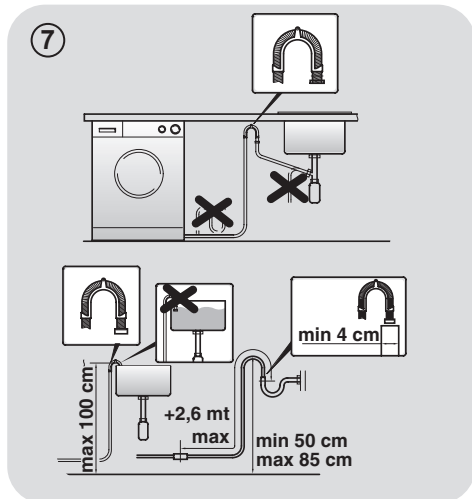
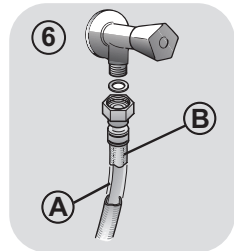
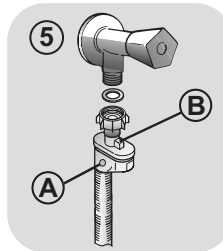
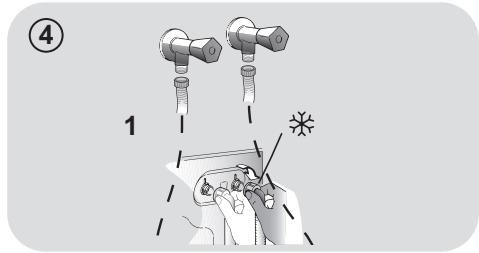
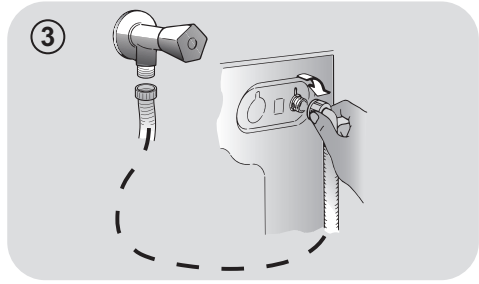

## Setting

- Near the washing machine to the wall, being careful that the tube is not bent or crushed, and place the drain tube in the tub or, preferably, connect it to a wall drain at least 50 cm high with diameter greater than the washing machine tube (fig. 7).

- Level the appliance using the feet as illustrated in **figure 8**:
  - a. turn the nut clockwise to release the screw;
  - b. rotate the foot to raise or lower it until it adheres to the floor;
  - c. lock the foot, screwing in the nut, until it adheres to the bottom of the washing machine.
- Plug in the appliance.



**WARNING:**  
contact the Customer Service Centre should the power cord need replacement.

## Detergent drawer

The detergent draw is split into 3 compartments as illustrated in **figure 9**:

- **compartment "1"**: for prewash detergent;
- **compartment "☼"**: for special additives, softeners, starch fragrances, etc.;



**WARNING:**  
only use liquid products; the washing machine is set to automatically dose additives at each cycle during the last rinse.

- **compartment "2"**: for washing detergent.

A **liquid detergent cup** is also included in some models (**fig. 10**). To use it, place it in **compartment "2"**. This way, liquid detergent will only enter the drum at the right time. The cup can also be used for bleach when the "Rinse" program is selected.



**WARNING:**  
some detergents are hard to remove. In this case we recommend using the specific container to be placed in the drum (example in figure 11).

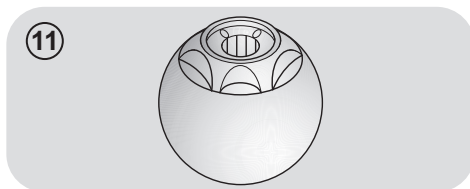
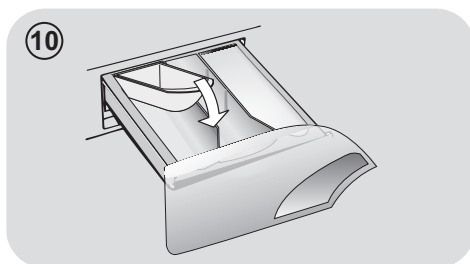
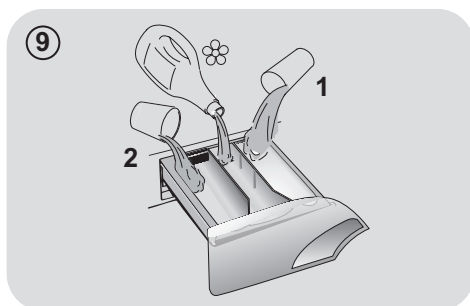
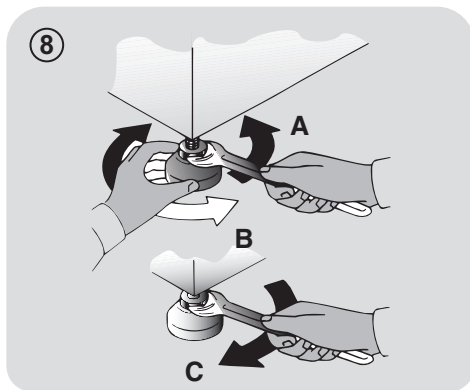



## 3. PRACTICAL TIPS

### Load tips

**WARNING: when sorting laundry, make sure:**

- have eliminated metallic objects such as barrettes, pins, coins, from laundry;
- to have buttoned pillow cases, closed zips, tied loose belts and long robe ribbons;
- to have removed rollers from curtains;
- to have carefully read clothing washing labels;
- to have removed any persistent stains using specific detergents.

- When washing rugs, bedcovers or other heavy clothing, we recommend you avoid centrifuging.
- To wash wool, make sure the item can be machine washed and marked by the “Pure virgin wool” symbol with the “Does not mat” or “Machine washable” label.

### Helpful suggestions for the user

A guide environmentally friendly and economic use of your appliance.

#### Maximise The Load Size

- Achieve the best use of energy, water, detergent and time by using the recommended maximum load size. Save up to 50% energy by washing a full load instead of 2 half loads.

#### Do you need to pre-wash?

- For heavily soiled laundry only!  
SAVE detergent, time, water and between 5 to 15% energy consumption by NOT selecting Prewash for slight to normally soiled laundry.

#### Is a hot wash required?

- Pretreat stains with stain remover or soak dried in stains in water before washing to

reduce the necessity of a hot wash programme.

Save up to 50% energy by using a 60°C wash programme.

#### Before using a drying programme...

- SAVE energy and time by selecting a high spin speed to reduce the water content in laundry before using a drying programme.

Following is a **quick guide** with tips and recommendations on **detergent use at the various temperatures**. In any case, always read the instructions on the detergent for correct use and doses.

**When washing heavily soiled whites, we recommend using cotton programs of 60°C or above and a normal washing powder (heavy duty) that contains bleaching agents that at medium/high temperatures provide excellent results.**

**For washes between 40°C and 60°C** the type of detergent used needs to be appropriate for the type of fabric and level of soiling.

Normal powders are suitable for “white” or colour fast fabrics with high soiling, while liquid detergents or “colour protecting” powders are suitable for coloured fabrics with light levels of soiling.

**For washing at temperatures below 40°C** we recommend the use of liquid detergents or detergents specifically labeled as suitable for low temperature washing.

For washing **wool** or **silk**, only use detergents specifically formulated for these fabrics.

## 4. MAINTENANCE AND CLEANING

To clean the washing machine exterior, use a damp cloth, avoiding abrasives, alcohol and/or solvents. The washing machine does not require any special care for ordinary cleaning: clean drawer compartments and the filter; some tips on how to move the machine or on long periods of disuse are provided below.

### Drawer cleaning

- We recommend you clean the drawer to avoid accumulating detergent and additive residue.
- To do this, extract the drawer using slight force, clean it with running water and reinsert it in its housing.

### Filter cleaning

- The washing machine comes with a special filter able to trap large residue, such as buttons or coins, which could clog the drain.
- Only available on certain models: pull out the corrugated hose, remove the stopper and drain the water into a container.
- Before unscrewing the filter, we recommend you place an absorbent cloth under it to keep the floor dry.
- Turn the filter counter-clockwise to the limit stop in the vertical position.
- Remove and clean the filter; when finished, replace it turning it clockwise.
- Repeat the previous steps in reverse order to reassemble all parts.

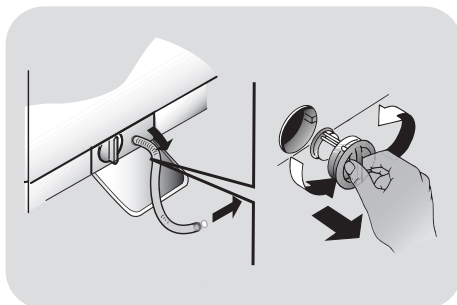

### Suggestions for moves or prolonged disuse

- Should the washing machine be stored in an unheated room for a long period of time, drain all water from tubes.
- Unplug the washing machine.
- Detach the tube from the strap and lower it, fully draining water into a bowl.
- Secure the drain tube with the strap when finished.

## 5. QUICK USER GUIDE

This washing machine automatically adapts the level of the water to the type and quantity of washing. This system gives a decrease in energy consumption and a sensible reduction in washing times.

### Program selection

- Turn on the washing machine and select the required program.
- Adjust the washing temperature if necessary and press the required "option" buttons.

#### DRYING

If you would like the drying cycle to begin automatically after washing, select the programme required using the **DRYING SELECTION** button.

Or you can finish the wash and then select the drying programme and load size.

- Press the **START/PAUSE** button to start washing.
- The message "end" will appear on the display or the corresponding led will turn on at the end of the program.

Wait until the porthole locked light turns off: about 2 minutes after the program ends.

- Turn off the washing machine.

For any type of wash, see the program table and follow the operating sequence as indicated.

### Technical data

**Water pressure:** min 0,05 Mpa / max 0,8 Mpa

**Spin r.p.m.:** See rating plate.

**Power input / Power current fuse amp / Supply voltage:** See rating plate.

## 6. CONTROLS AND PROGRAMS

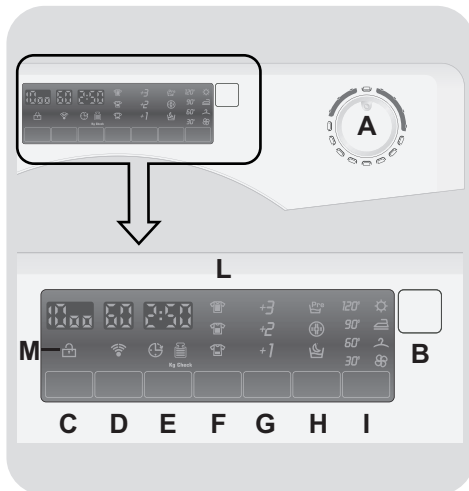

- A Programme selector with OFF position**
- B START/PAUSE button**
- C SPIN SELECTION button**
- D TEMPERATURE SELECTION button**
- E DELAY START button**
- F STAIN LEVEL button**
- G EXTRA RINSE button**
- H OPTIONS button**
- I DRYING SELECTION button**
- L Digital display**
- M DOOR LOCKED indicator light**



### **WARNING:**

Don't touch the display while inserting the plug because the machines calibrates the systems during the first seconds: touching the display, the machine couldn't work property. In this case, remove the plug and repeat the operation.

## Opening the door

A special safety device prevents the door from being opened immediately after the end of the cycle.

Wait for **2 minutes** after the wash cycle has finished and the "Door Security" light has gone out before opening the door.

## Programme selector with OFF position

When the programme selector is turned the display lights up to show the settings for the programme selected.

For energy saving, at the end of the cycle or with an inactivity period, the display level contrast will decrease.

**N.B.:** To switch the machine off, turn the programme selector to the **OFF** position.

- Press the **START/PAUSE** button to start the selected cycle.
- Once a programme is selected the programme selector remains stationary on the selected programme till cycle ends.

- Switch off the washing machine by turning the selector to **OFF**.

The programme selector must be returned to the **OFF** position at the end of each cycle or when starting a subsequent wash cycle prior to the next programme being selected and started.

## START/PAUSE button

Close the door **BEFORE** selecting the button **START/PAUSE**.

- Press to start the selected cycle.

When the **START/PAUSE** button has been pressed, the appliance can take few seconds before it starts working.

## ADD OR REMOVE ITEMS AFTER THE PROGRAMMES HAS STARTED (PAUSE)

- Press and hold the **START/PAUSE** button for about **2 seconds** (some indicator light and the time remaining indicator will flash, showing that the machine has been paused).
- Wait **2 minutes** until the safety device unlocks the door.
- After you have added or removed items, close the door and press the **START/PAUSE** button (the programme will start from where it left off).

## CANCELLING THE PROGRAMME

- To cancel the programme, set the selector to the **OFF** position.

The option buttons should be selected before pressing the **START/PAUSE** button.

If an option is selected that is not compatible with the selected programme then the option indicator first flashes and then goes off.

## SPIN SELECTION button

- By pressing this button, it is possible to reduce the maximum speed, and if you wish, the spin cycle can be cancelled.
- To reactivate the spin cycle press the button until you reach the spin speed you would like to set.

To prevent damage to the fabrics, it is not possible to increase the speed over that which is automatically suitable during the selection of the program.

- It is possible to modify the spin speed without pausing the machine.

The machine is fitted with a special electronic device, which prevents the spin cycle should the load be unbalanced.

This reduces the noise and vibration in the machine and so prolongs the life of your machine.

## TEMPERATURE SELECTION button

- This button allows you to change the temperature of the wash cycles.
- It is not possible to raise the temperature over the maximum allowed for every programme, in order to save the fabrics.

## DELAY START button

- This button allows you to pre-programme the wash cycle to delay the start of the cycle for up to **24 hours**.
- To delay the start use the following procedure:
  - Set the required programme.
  - Press the button once to activate it (**h00** appears on the display) and then press it again to set a **1 hour** delay (**h01** appears on the display). The pre-set delay increases by **1 hour** each time the button is pressed, until **h24** appears on the display, at which point pressing the button again will reset the delay start to zero.
  - Confirm by pressing the **START/PAUSE** button (the light on the display starts to flash). The countdown will begin and when it has finished the programme will start automatically.

- It is possible to cancel the delay start by turning the programme selector to **OFF**.

*If there is any break in the power supply while the machine is operating, a special memory stores the selected programme and, when the power is restored, it continues where it left OFF.*

## STAIN LEVEL button

- By selecting this button there is a choice of 3 levels of wash intensity, depending on how much the fabrics are soiled (can be used only on some programmes as shown in the table of programmes).

- Once the programme has been selected the indicator light will automatically show the stain level set for that programme.
- Selecting a different stain level the relevant indicator will light up.

### EXTRA RINSE button

- This button allows you to add rinses at the end of the washing cycle. The maximum number of extra rinses is related to the programme selected.
- This function has been studied for the people with delicate and sensitive skin, for which also a least residue of detergent can cause irritations or allergies.
- It advises to also use this function for the children items and in case of washings of very dirty items, for which it is due to use a lot of detergent, or in the washing of toweling items whose fibres mostly have the tendency to hold the detergent.

### OPTIONS button

You can choose between three different options:

#### - PREWASHING

- This option allows you to make a prewash and it is particularly useful for heavily soiled loads (can be used only on some programmes as shown in the table of programmes).
- We recommend you use only 20% of the recommended quantities shown on the detergent pack.

#### - HYGIENE

- With this option it is possible to hygienize the clothes, the washing programme reach a temperature of 60°C.

#### - NIGHT CYCLE

- This option reduces the intermediate spin speed to 400 rpm, where applicable, increase the water level during rinsing and keep the laundry immersed in water after the final rinse, in order to spread the fibre evenly.
- During the phase in which the water is held in the tub, the relevant indicator light blink to show that the machine is at a standstill.
- Deselect the option to end the cycle with a spin dry (which may be reduced or cancelled using the appropriate button) and emptying phase.
- Thanks to electronic control, the water in the intermediate phases is emptied silently, making this option very useful for washing at night.

### DRYING SELECTION button

- Ensure that the programme selector is not in the **OFF** position then press the button to select the required drying programme: an indicator will light to display the drying result selected each time you press the button.
- To cancel the selection before the start of a drying programme, press the button repeatedly until the indicators go out or return the programme selector to the **OFF** position.
- To cancel the cycle during the drying phase, hold the button down for about **3 seconds** until the cooling indicator lights up.
- Given the high temperature inside the drum, we recommend that you allow the dryer to complete the cool down period before returning the programme selector to the **OFF** position and removing the laundry.

## Digital Display

The display's indicator system allows you to be constantly informed about the status of the machine.

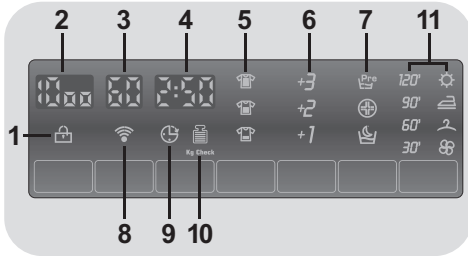

### 1) DOOR LOCKED INDICATOR LIGHT



- The indicator light is illuminated when the door is fully closed.

**Close the door BEFORE selecting the START/PAUSE button.**

- When **START/PAUSE** is pressed on the machine with the door closed, the indicator will flash momentarily and then illuminate.

**If the door is not properly closed, the light will continue to flash for about 7 seconds, after which the start command will be automatically delete. In this case, close the door in the proper way and press the START/PAUSE button.**

- A special safety device prevents the door from being opened immediately after the end of the cycle. Wait for **2 minutes** after

the wash cycle has finished and the DOOR LOCKED light has gone out before opening the door. At the end of the cycle turn the programme selector to **OFF**.

### 2) SPIN SPEED



This show the spin speed of the selected programme that can be changed or omitted by the relevant button.

### 3) WASH TEMPERATURE



This show the washing temperature of the selected programme that can be changed (where allowed) by the relevant button.

### 4) CYCLE DURATION



- When a programme is selected the display automatically shows the cycle duration, which can vary, depending on the options selected.

- Once the programme has started you will be kept informed constantly of the time remaining to the end of the wash.

- The appliance calculates the time to the end of the selected programme based upon a standard loading, during the cycle, the appliance corrects the time to that applicable to the size and composition of the load.

- If automatic washing/drying is selected, at the end of the wash phase, the drying time remaining to the end will be shown on the display.

## 5) STAIN LEVEL

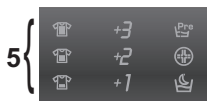

- Once the programme has been selected, the indicator light will automatically show the stain level set for that programme.
- Selecting a different stain level the relevant indicator will light up.

## 6) EXTRA RINSES



The indicator lights show the extra rinses selected by the relevant button.

## 7) OPTIONS

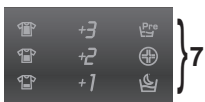

The indicator lights show the option that can be selected by the relevant button (**PREWASH**, **HYGIENE** and **NIGHT CYCLE**).

## 8) Wi-Fi (some models only)



- In the models with the Wi-Fi option, the icon indicates that the Wi-Fi system is working.
- For all other information in the Wi-Fi system, there is a specific manual inside the machine.

## 9) DELAY START

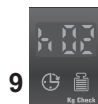

This flashes when delay start has been set.

## 10) Kg Check (function active only on Cotton and Synthetics programmes)



- During the first minutes of the cycle, the "Kg Check" indicator remain on while the intelligent sensor will weigh the laundry and adjust the cycle time, water and electricity consumption accordingly.
- Through every wash phase "Kg Check" allows to monitor information on the wash load in the drum and in the first minutes of the wash it:
  - adjusts the amount of water required;
  - determines the length of the wash cycle;
  - controls rinsing according to the type of fabric selected to be washed it;
  - adjusts the rhythm of drum rotation for the type of fabric being washed;
  - recognizes the presence of lather, increasing, if necessary, the amount of water during rinsing;
  - adjusts the spin speed according to the load, thus avoiding any imbalance.





## 11) DRYING PROGRAMME INDICATORS



The indicators display the type of the drying programme.

### Automatic drying programmes

 **Extra dry** programme (suitable for towels, bathrobes and bulky loads).

 **Iron dry** programme (that leaves the laundry ready for ironing).

 **Cupboard dry** programme (for items that will be put away without ironing).

- By selecting one of these automatic programmes, the washer dryer will calculate the time needed for drying and the level of moisture remaining in the laundry, according to the load and drying type selected.
- After pressing the **START/PAUSE** button, the display will show the drying time remaining.

The appliance calculates the time to the end of the selected programme based upon a standard loading. During the cycle, the appliance corrects the time according to the size and composition of the load.

### Timed drying programmes

120'  
90'  
60'  
30'

They may be used to select timed drying programmes.

### Cool down phase





Activated during the final cool down period, in the last 10/20 minutes of each drying phase.

### Useful tips

- The 30 minute drying programme is recommended for small loads (less than 1 kg) or only slightly damp loads.
- Your washer dryer automatically ends the cycle when it reaches the selected drying level.
- In order to ensure the correct operation of the appliance, it is advisable not to interrupt the drying phase unless it is absolutely necessary.

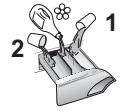
# Table of programmes



PROGRAM		kg * (MAX.)					TEMP.°C		DETERGENT		
							Recommended	Max.	2		1
<b>Perfect 20° Mix &amp; Wash</b>	1) 2)	4	5,5	6	6,5	7	20°	20°	●	●	
<b>Intensive 40°</b>	1) 2)	4	5,5	6	6,5	7	40°	40°	●	●	
<b>Hygiene 60°</b>	2)	4	5,5	6	6,5	7	60°	60°	●	●	
<b>Perfect Rapid 59 Min</b>	2)	2	3	3	3,5	3,5	40°	40°	●	●	
<b>Rapid 30 Min</b>	2)	2	2,5	2,5	2,5	2,5	30°	30°	●	●	
<b>Rapid 14 Min</b>	2)	1	1,5	1,5	1,5	1,5	30°	30°	●	●	
<b>Drain + Spin</b>	2)	-	-	-	-	-	-	-			
<b>Rinse</b>	2)	-	-	-	-	-	-	-	△	●	
<b>Cottons**</b>	1) 2)	6	8	9	10	11	60°	90°	●	●	(●)
<b>Mixed</b>	1) 2)	3	4	4,5	5	5,5	40°	60°	●	●	(●)
<b>Delicates</b>		2	2,5	2,5	2,5	2,5	40°	40°	●	●	
<b>Wool / Hand</b>		2	2	2	2	2	30°	30°	●	●	
<b>Low Heat</b>		3	4	4,5	5	5,5	-	-			
<b>High Heat</b>		4	5	6	7	7	-	-			
<b>Rapid W&amp;D 59 Min</b>		1,5	1,5	1,5	1,5	1,5	30°	30°	●	●	

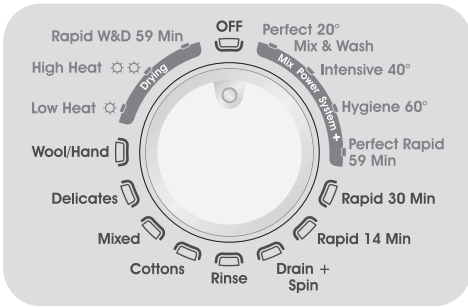

**Please read these notes:**

\* Maximum load capacity of dry clothes, according to the model used (see control panel).

**INFORMATION FOR THE TEST LABORATORIES (Ref. EN 50229 Standards)**

**Washing**

Use the programme \*\* with the maximum degree of soiling selected, maximum spin speed and a temperature of 60°C. Programme recommended also for test with a lower temperature.

**Drying**

**First drying with A kg** (a load consist: pillowcases and hand-towels) selecting the cotton drying programme (☀☀) cupboard dry (2).

**Second drying with B kg** (a load consist: sheets and hand towels) selecting the cotton drying programme (☀☀) cupboard dry (2).

Capacity (washing) (kg)	A (kg)	B (kg)
	First drying	Second drying
6	4	2
8	5	3
9	6	3
10	7	3
11	7	4

The spin speed may also be reduced, to match any guidelines suggested on the fabric label, or for very delicate fabrics cancel the spin completely this option is available with a spin speed button. This function can be activated with the button SPIN SELECTION.

If the label does not indicate specific information, it is possible to use the maximum spin expected in the program. An over dosing of detergent can cause excessive foaming.

If the appliance detects the presence of excessive foam, it may exclude the spinning phase or extend the duration of the program and increase water consumption.

- Only with PREWASH option selected (programmes with PREWASH option available).

▲ **(Only for models with liquid detergent compartment)**

When only a limited number of articles have stains which require treatment with liquid bleaching agents, preliminary removal of stain can be carried out in the washing machine.

Pour the bleach into the liquid bleach container, inserted into the compartment marked "2" in the detergent drawer, and set the special programme RINSE.

When this phase has terminated, turn the programme selector on the OFF position, add the rest of the fabrics and proceed with a normal wash on the most suitable programme.

- 1) For the programmes shown you can adjust the duration and intensity of the wash using the STAIN LEVEL button.
- 2) Programmes for automatic drying.

## Programmes selection

To clean different types of fabrics and various levels of dirt, the washing machine has specific programs to meet every need of washing (see table of programmes).

### Mix Power System +

The washing machine is equipped with an innovative pre-mix of detergent and water. A jet of water under high pressure sprays the mixture directly in the load.

In the initial phase of the wash cycle, the high pressure spray facilitate the penetration of the wash solution through the fibres, thoroughly removing dirt ensuring the best wash performance.

The system also delivers the "Mix Power System +", during the rinse, the complete removal of the residues of detergent due to its high pressure water jet, which invests the laundry.

### Perfect 20°C – Mix & Wash

This innovative "Mix Power System +" technology, allows you to wash fabrics such as cottons, synthetics and mixed fabrics at 20°C with a performance which is comparable to a 40°C wash.

The consumption of this programme is about 50% of a conventional 40°C. Cottons wash.

We suggest a wash load equal to 2/3 of the maximum capacity of the machine.

This programme applies to the washing system "Mix & Wash" which allows you to wash different fabrics and colours together.



#### **WARNING:**

**New coloured garments should be washed separately for at least 5 or 6 washes.**

**Certain large dark items such as jeans and towels should always be washed separately.**

**Never mix NON COLOURFAST fabrics.**

### Intensive 40°

This programme is suitable for cotton garments and achieves excellent cleaning results at 40°C ensuring the application of fabrics and colors.

### Hygiene 60°

This programme is suitable for cotton garments and has been specially developed to remove stubborn stains already at 60°C thanks to the "Mix Power System +" technology.

### Perfect Rapid 59 Min

This specially designed programme maintains the high quality wash performance whilst greatly reducing the wash time. The programme is designed for a reduced load (see table of programmes).

### Rapid 30 Min

A complete washing cycle (wash, rinse and spin). This programme is particularly suited to slightly dirty cottons and mixed fabrics. With this programme it is recommended to use only 20% of the detergent normally used to avoid waste.

### Rapid 14 Min

A complete washing cycle (wash, rinse and spin). This programme is suited to slightly dirty cottons and mixed fabrics. With this programme it is recommended to use only 20% of the detergent normally used to avoid waste.

### Drain + Spin

The program completes the drain and a maximum spin. It is possible to delete or reduce the spin with the SPIN SELECTION button.

### Rinse

This program performs 3 rinses with an intermediate spin (which can be reduced or excluded by using the appropriate button). It is used for rinsing any type of fabric, for example after a wash carried out by hand.

### Cottons

This program is suitable to clean normally soiled cotton laundry and it is the most efficient program in terms of combined energy and water consumptions for washing cotton laundry.

### Mixed

The washing and rinsing are optimized in the rhythms of rotation of the drum and to the water levels. The gentle spin, ensures a reduced formation of creases in the fabric.

### Delicates

This program alternates among moments of work during breaks and is particularly suitable for washing delicate fabrics. The wash cycle and rinses are carried out with a high level of water to ensure the best performance.

### Wool/Hand

This program performs a wash cycle dedicated to the wool fabrics that can be washed in a washing machine, or the articles to be washed by hand.

## DRYING



### WARNING:

**Dispensers used for concentrated powders and liquid detergents must be removed from the drum before commencing the tumble drying programmes.**

The drum changes direction during the drying cycle to prevent the laundry from tangling and producing even more drying. Cool air is used during the last 10/20 minutes of the drying cycle to minimize creasing.

### Low Heat

Low temperature drying programme recommended for synthetics and mixed fibres (always refer to the laundry care label).

### High Heat

High temperature drying programme recommended for cottons and linen items (always refer to the laundry care label).





### Rapid W&D 59 Min

When you only have a few items to wash and dry in a hurry, this 59 minute cycle is the ideal time saver! Suitable for a light 1,5 kg load size (e.g. 4 shirts) or slightly dirty fabrics, this cycle will wash, rinse, spin and dry your garments in under an hour. We recommend that you reduce the detergent dosage when using this programme to avoid wastage.

## 7. DRYING CYCLE

- Drying guidance advice is general, but practical experience of using the product will help you to achieve the best drying results.
- We recommend setting a lower drying time than indicated, when first using the appliance in order to establish the degree of dryness required.
- We recommend not drying fabrics that fray easily, such as rugs or garments with a deep pile, in order to avoid air duct logging.
- We recommend that you sort the laundry by the following methods:

- **By drying care symbols, which are displayed on the clothing labels**

-  Suitable for tumble drying.
-  Tumble dry at high temperature.
-  Tumble dry at low temperature only.
-  **DO NOT** tumble dry.

**If the fabric does not have a care label, you should assume that it is not suitable for drying.**

- **By size and thickness**

Whenever the wash load is bigger than the drying capacity, separate the clothes according to thickness (e.g. towels from thin underwear).

- **By fabric type**

Cottons/linen: towels, cotton jersey, bed and table linen.

Synthetics: blouses, shirts, overalls, etc. made of polyester or polyamide, as well as for cotton/synthetic mixes.

- Only dry pre-spun laundry.
- The washer dryer can perform the following types of drying:

- **Low temperature** drying programme recommended for mixed fabrics (synthetics/cotton) synthetic fabrics (☼ symbol on programme dial).

- **High temperature** drying programme recommended for cotton, terry toweling, linen, hemp fabrics, etc... (☼☼ symbol on programme dial).

**During the drying phase the drum will accelerate to a higher speed to distribute the load and to optimize the drying performance.**

### The correct way to dry

**The appliance door is fitted with a protective shield to prevent contact with the glass door which can reach high temperatures, during the drying cycle.**

**It should not be necessary to remove the shield from the machine during the normal course of use.**

- Open the door.
- Fill with the laundry, not exceeding the maximum drying load indicated in the programme table. For large items (e.g. sheets) or very absorbent items (e.g. towels or jeans), it is a good idea to reduce the load.
- Close the door.

- Turn the programme dial to the more suitable drying programme for your laundry.
- Select the degree of dryness that you require choosing one of 3 automatic programmes:

 **Extra dry** programme (suitable for towels, bathrobes and bulky loads).

 **Iron dry** programme (that leaves the laundry ready for ironing).

 **Cupboard dry** programme (for items that will be put away without ironing).

- If you wish to select a **timed drying** programme, press the **DRYING SELECTION** button until the required time indicator lights up.
- Make sure that the water inlet valve is open.
- Make sure water drain is correctly positioned.



**WARNING:**

Do not dry woollen garments or articles with special padding (e.g. quilts, quilted anoraks, etc.) and very delicate fabrics. If garments are drip/dry, load less items as to prevent creasing.

- When the programme is finished the word **"End"** will appear on the display. After **5 minutes** the appliance will go into standby mode (on certain models, the display will show two lines).

● After the programme has finished please wait for about **2 minutes** until the **DOOR LOCKED** indicator has gone out before opening the door.

- Switch off the machine by turning the programme selector to the **OFF** position.

- Open the door and remove the laundry.

- Turn off the tap.

### CANCELLING THE DRYING PROGRAMME

- To cancel the drying programme, press and hold the **DRYING SELECTION** button for about **3 seconds**.



**WARNING:**

After cancelling the drying programme, the cool down phase will begin and you must wait for about 10/20 minutes before opening the door.

- Press the **START/PAUSE** button.
- The drying phase will begin with the programme dial fixed on the selected programme until the end of drying.
- The drying programme indicator will be on, until the cool down phase begins and the corresponding indicator is on.

## 8. AUTOMATIC WASHING/DRYING CYCLE

You cannot exceed the maximum dryable load of laundry indicated in the programme table, otherwise the laundry will not be dried satisfactorily.

### - Washing

- Open the drawer and put in the correct amount of detergent.
- Refer to the list of washing programmes for the fabrics to be washed (e.g. very dirty cotton) and turn the selector knob to the required programme.
- Adjust the wash temperature if necessary.
- Press the option buttons (if required).
- Check that the tap is turned on and that the discharge hose is positioned correctly.

### - Drying

- Select the degree of dryness that you require choosing one of 3 automatic programmes:

 **Extra dry** programme (suitable for towels, bathrobes and bulky loads).

 **Iron dry** programme (that leaves the laundry ready for ironing).

 **Cupboard dry** programme (for items that will be put away without ironing).

- If you wish to select a **timed drying** programme, press the **"DRYING SELECTION"** button until the required time indicator lights up.
- Press the **START/PAUSE** button.

- The programme selector remains in the same stationary position throughout the cycle until it ends.
- At the end of the wash phase the display will show the drying time remaining.
- The washer dryer will then complete the entire drying programme.
- The drying programme indicator will be on, until the cool down phase begins and the corresponding indicator is on.
- When the programme is finished the word **"End"** will appear on the display. After **5 minutes** the appliance will go into standby mode (on certain models, the display will show two lines).
- After the programme has finished please wait for about **2 minutes** until the **DOOR LOCKED** indicator has gone out before opening the door.
- Switch off the machine by turning the programme selector to the **OFF** position.
- Open the door and remove the laundry.
- Turn off the tap.

### CANCELLING THE DRYING PROGRAMME

- To cancel the drying programme, press and hold the **DRYING SELECTION** button for about **3 seconds**.



#### **WARNING:**

After cancelling the drying programme, the cool down phase will begin and you must wait for about **10/20 minutes** before opening the door.



## 9. CUSTOMER SERVICE CENTRE AND WARRANTY

If you believe the washing machine is not working correctly, consult the quick guide provided below with some practical tips on how to fix the most common problems.

<b>Problem</b>	<b>Possible causes and practical solutions</b>
<b><i>The washing machine does not work/start</i></b>	Make sure it is correctly plugged in.
	Make sure power is on.
	Check whether the required program was correctly selected and to have correctly started the machine.
	Make sure the fuse has not blown and that the wall socket is working, testing it with another appliance such as a lamp. The porthole may not be correctly closed: open and close it again.
<b><i>The washing machine does not fill with water</i></b>	Make sure the water faucet is open.
	Make sure the timer is correct set.
<b><i>The washing machine does not drain water</i></b>	Make sure the filter is not clogged.
	Make sure the drain hose is not bent.
	Make sure there are no foreign objects in the filter.
<b><i>Water leaked on the floor near the washing machine</i></b>	This may be due to a leak in the gasket between the faucet and supply tube; in this case, replace it and tighten the tube and faucet.
<b><i>The washing machine does not centrifuge</i></b>	This could be due to the fact that water has not been completely drained: wait a few minutes.
	Some models include a "no centrifuge" function: make sure it is not on.
	An excessive amount of detergent could prevent centrifuge: reduce the amount at the next wash.
<b><i>Strong vibrations are heard during centrifuge</i></b>	The washing machine may not be fully levelled: if necessary, adjust the feet as indicated in the specific section.
	Make sure transport brackets were removed.
	Make sure the load is evenly distributed.
<b><i>If a specific ERROR appears of blinks</i></b>	If <b>error no. 0, 1, 5, 7 or 8</b> appears or blinks, contact the Customer Service Centre directly.
	If <b>error no. 2</b> appears or blinks, the machine does not load water. Make sure the water faucet is open.
	If <b>error no. 3</b> appears or blinks, the machine does not correctly drain. Make sure the drain is free and that the drain hose is not bent.
	If <b>error no. 4</b> appears or blinks, the machine is too full. Close the water faucet and contact the Customer Service Centre.
	If <b>error no. 9</b> appears or blinks, turn off the washing machine, wait 10 – 15 seconds and restart the program.

The use of ecological detergents without phosphates may cause the following effects:

- **cloudier rinse drain water:** This effect is tied to the suspended zeolites which do not have negative effects on rinse efficiency.

- **white powder (zeolites) on laundry at the end of the wash:** this is normal, the powder is not absorbed by fabric and does not change its colour.

- **foam in the water at last rinse:** this does not necessary indicate poor rinsing.

- **abundant foam:** This is often due to the anionic surfactants found in the detergents which are hard to eliminate from laundry.

In this case, do not re-rinse to eliminate these effects: it will not help at all.

If the problem persists or if you suspect a malfunction, immediately contact the **Candy** Customer Service Centre.

You can also register for the **Candy** service plan to receive free home service after the warranty expires.

**Attention:** the call is not toll-free. The cost will be communicated in a voice message by your telephone operator's customer service.

**Candy** recommends you always use original spare parts available at our Customer Service Centre.

### **Warranty**

The product is guaranteed under the terms and conditions stated on the certificate included with the product. The warranty certificate must be duly filled in and stored, so as to be shown to the Authorised **Candy** Service Centre in case of need.

### **Register your product!**

Don't waste time. Register your washing machine at once, and discover the benefits to which you are entitled. Discover how at [www.registercandy.com](http://www.registercandy.com) or by calling the number stated on the related material.

**The manufacturer declines all responsibility for any printing errors in the booklet included with this product. Moreover, it also reserves the right to make any changes deemed useful to its products without changing their essential characteristics.**



