

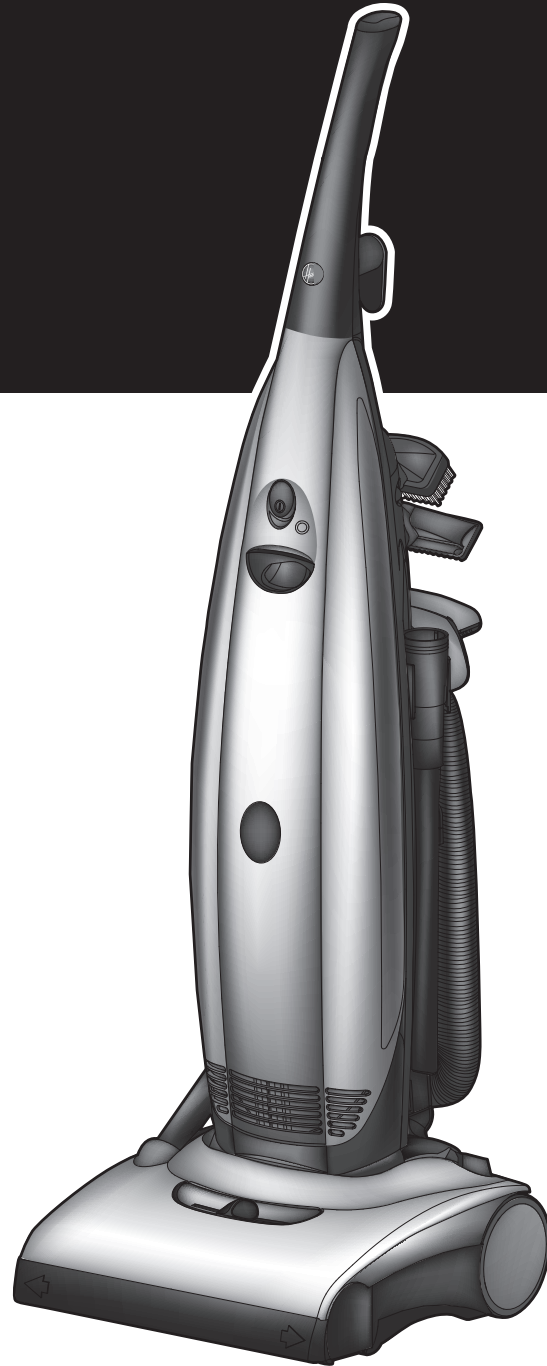

GENERATION FUTURE

HOOVER



USER MANUAL

IMPORTANT SAFETY REMINDERS

This appliance should only be used for domestic cleaning, as described in this user guide. Please ensure that this guide is fully understood before operating the appliance.

Do not leave the appliance plugged in. Always switch off and remove the plug from the socket after use, or before cleaning the appliance or any maintenance task.

This appliance can be used by children aged from 8 years and above and persons with reduced physical, sensory or mental capabilities or lack of experience and knowledge if they have been given supervision or instruction concerning use of the appliance in a safe way and understand the hazards involved. Children shall not play with the appliance. Cleaning and user maintenance shall not be made by children without supervision.

If the power cord is damaged stop using the appliance immediately. To avoid a safety hazard, an authorised Hoover service engineer must replace the power cord.

Keep hands, feet, loose clothing and hair away from rotating brushes.

Use only attachments, consumables or spares recommended or supplied by Hoover.

When using cleaning tools ensure that the appliance is kept in the upright (parked) position. This will avoid possible damage to the carpet or floor covering. When cleaning stairs, do not position the appliance above you.

Static electricity: some carpets can cause a small build up of static electricity. Any static discharge is not hazardous to health.

Do not use your appliance out of doors or on any wet surface or for wet pick up.

Do not pick up hard or sharp objects, matches, hot ashes, cigarette ends or other similar items.

Do not spray with or pick up flammable liquids, cleaning fluids, aerosols or their vapours.

Do not run over the power cord when using your appliance or remove the plug by pulling on the power cord.

Do not continue to use your appliance if it appears faulty.

Hoover service: To ensure the continued safe and efficient operation of this appliance we recommend that any servicing or repairs are only carried out by an authorised Hoover service engineer.

Do not stand on or wrap the cord around arms or legs when using your appliance.

Do not use the appliance to clean animals or people.

When using the cleaning tools, ensure to always steady the appliance with your other hand. This will ensure that the appliance does not fall while in use.

WARNING: A thermal cut out switches off the appliance to prevent overheating if it is used when full or there is a blockage or dirty filters. If this should happen then switch off, unplug and correct the fault. It will take approximately 45 minutes for the cut out to automatically reset.

The Environment

The symbol on this appliance indicates that this appliance may not be treated as household waste. Instead it must be handed over to the applicable collection point for the recycling of electrical and electronic equipment. Disposal must be carried out in accordance with local environmental regulations for waste disposal. For more detailed information about treatment, recovery and recycling of this appliance, please contact your local city office, your household and waste disposal service or the shop where you purchased the appliance.



 This appliance complies with the European Directives 2006/95/EC, 2004/108/EC and 2011/65/EU.

HOOVER Limited, Pentrebach, Merthyr Tydfil, Mid Glamorgan, CF48 4TU, UK

GETTING TO KNOW YOUR CLEANER

Effortless cleaning with your new Hoover

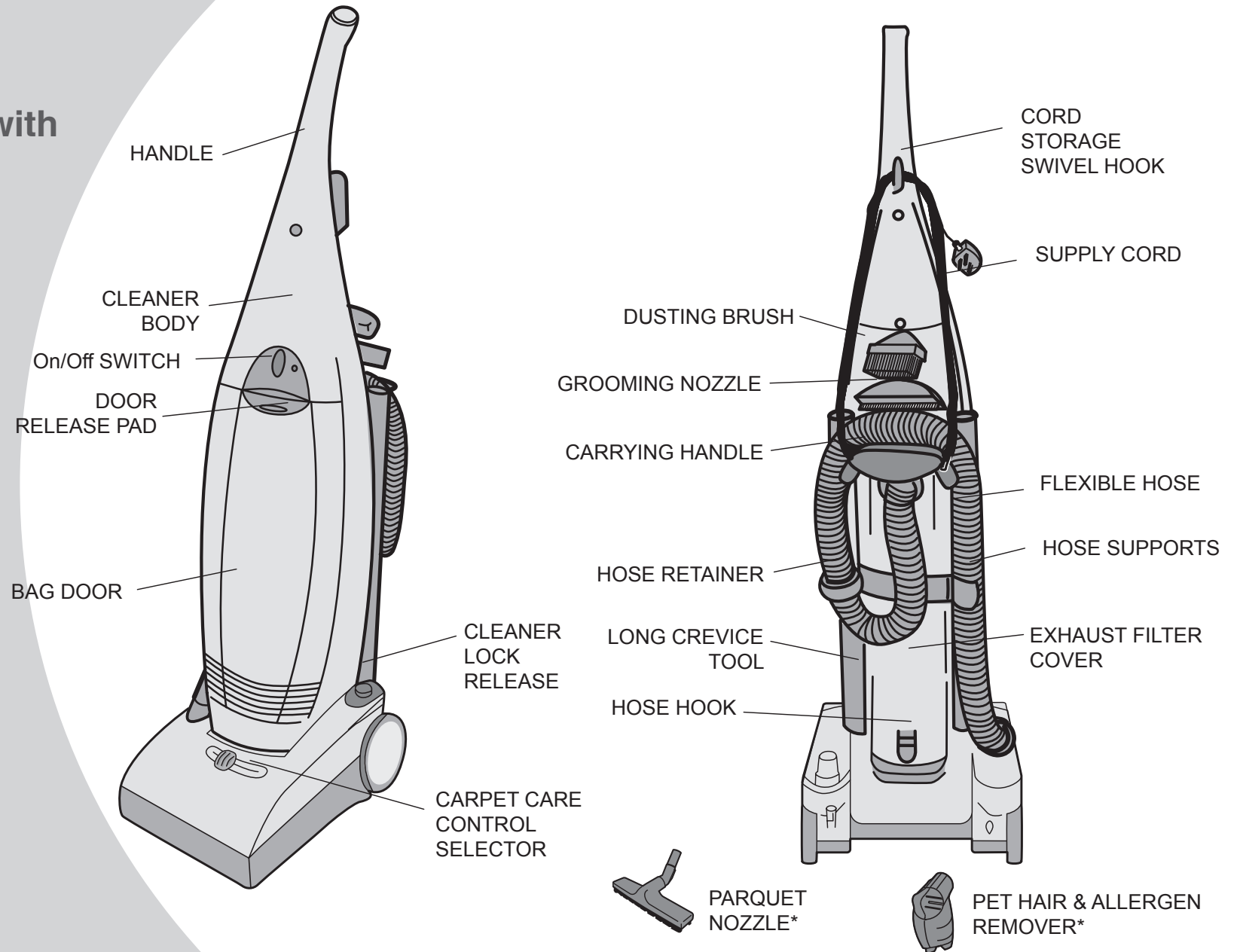

This vacuum cleaner is supplied with an Energy Label as required by European Regulation (EU) 665/2013.

(*Certain models only)

PREPARING TO USE YOUR CLEANER



Insert handle into body of cleaner. Slide into position.

Ensure handle is flush with body of cleaner.

Tighten large screw (pre-fitted to handle upper hole). Insert small screw into handle lower hole and tighten.

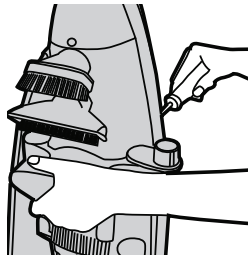

Affix carrying handle to the back of product

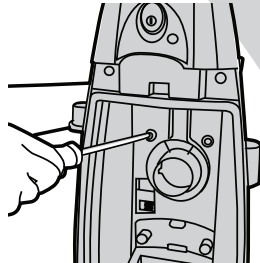

Screw top two provided screws to affix carrying handle in place

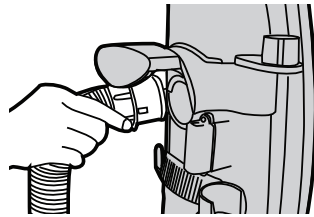

Connect hose to back of product.

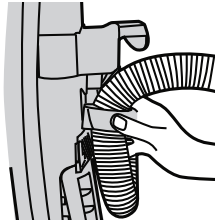

Latch hose retainer to hose support.

POWER SWITCH SETTING

Switching on and off

Push bottom of the On/Off switch to switch on.
Push top of the On/Off switch to switch off.

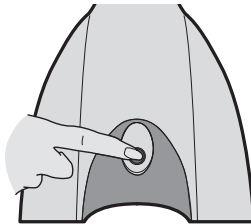

CLEANER LOCK RELEASE

Unlock the cleaner by pressing down on pedal with foot. For floor cleaning under low furniture and some maintenance tasks simply press the pedal again and lower handle to the floor.

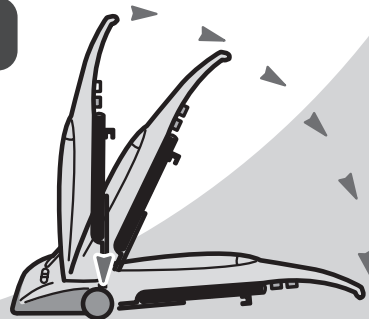

CARPET CARE CONTROL SELECTOR

The carpet care control selector raises and lowers the height of the nozzle.

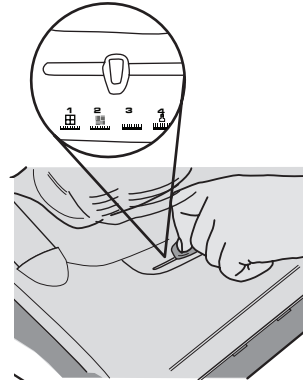

Ensure that the cleaner is in the upright (parked) position and move the selector to the required setting for the carpet type or floor covering.

To obtain the best performance and energy efficiency^{#1} it is recommended that the adjustment setting position **1** is used for the main cleaning operations. The other adjustment settings are for ease of use, use on longer pile carpets, or for specialist cleaning tasks.

Settings

1. Best performance and energy efficiency, short to medium pile carpets, hard wooden floors, wooden floor boards with crevices, ceramic tiles.
2. Medium pile carpets, delicate floor coverings such as vinyl or linoleum, parquet flooring.
3. For longer pile carpets the motion resistance may increase. Use these intermediate settings to reduce the force required to push the vacuum cleaner.
4. Luxury carpet and Tool mode

IMPORTANT: Using this cleaner for loop pile carpets with pile greater than 30mm is not recommended. Please consult the floorcare/carpet manufacturer's recommended cleaning instruction before vacuuming.

IMPORTANT: When cleaning delicate hard floors such as vinyl or linoleum the selector switch must be moved to position **2**. Failure to do so may cause damage to the floor surface.

This vacuum cleaner is supplied with an Energy Label as required by European Regulation (EU) 665/2013. If the label shows a red prohibition circle on the right covering the hard floor symbol, then this indicates that the vacuum cleaner is not suitable for use on hard floors.

#1NOTE: Dust pick up ability carpet, dust pick up ability hard floor, and energy efficiency in accord with Commission Regulations (EU) 665/2013 and (EU) 666/2013.

CLEANING TOOLS*

! **IMPORTANT:** When using cleaning tools, the cleaner must be kept in the upright (parked) position, particularly when cleaning stairs. The carpet height selector should also be set to tool mode:

Pet Hair & Allergen Remover *
Ideal for removing pet hairs.
Do not touch the rotating brush.



Parquet Nozzle*
Ideal for cleaning delicate surfaces.
For use combine with the Rigid Extension tube.

Extension Tube*
Fitted on the flexible hose and with accessories at its end, it is ideal for stair cleaning.

All accessories can fit on the end of the flexible hose or at the end of the extension tube*. Combine accessories depending on use.

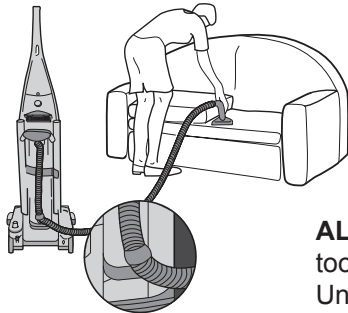

ALWAYS attach hose retainer to hook when using cleaning tools.
Unhook after use.

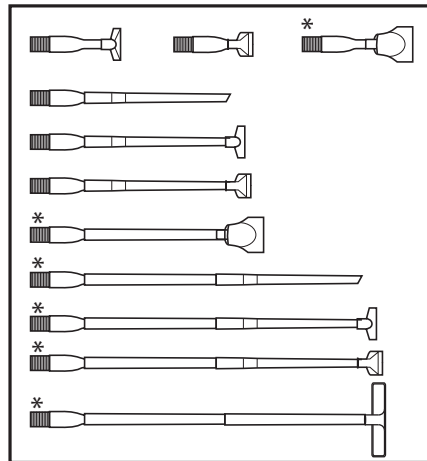

CLEANING THE STAIRS

It is dangerous to place the cleaner above you whilst cleaning the stairs.

ALWAYS work with the cleaner below you. Ensure it is positioned up against the bottom step.

DO NOT attach hose retainer when cleaning the stairs.



CHANGING THE DISPOSABLE BAG

! **IMPORTANT:** Switch cleaner off and remove plug from electricity supply before changing the bag. Your cleaner is supplied with a bag already fitted. This bag **must not be re-used.**

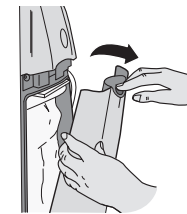

To remove bag:

Press down on the door release pad and remove door.

Gently pull bag collar retainer from the hose inlet by pulling off the stiff cardboard at the top of the bag.

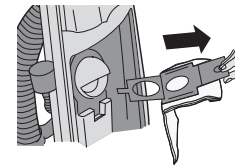

Slide bag from bag collar retainer by pulling on stiff cardboard at top of the bag collar. A shutter will automatically seal off bag opening.

Discard full bag.

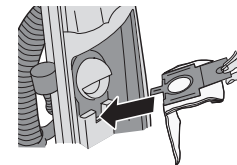

To fit new bag:

Push the tab on the cardboard collar into the slot beneath the hose inlet.

Push the bag collar over the hose inlet until it is firmly in place.

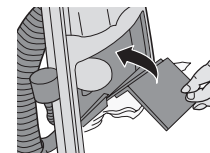

Open out the folds in the bag and refit bag door.

* Certain models only

CLEANING THE FILTERS*

Pre- motor filter

The pre-motor filter should be washed every three months.

The Carbon filter is normally maintenance free, this component should not be washed. If a replacement is required please contact our spares department.

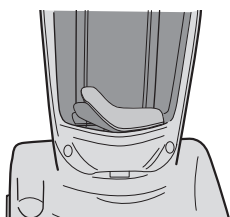

Remove bag door and lift out filter.

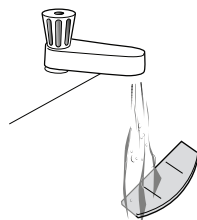

Wash filter under hand warm water.
DO NOT USE HOT WATER OR DETERGENTS!

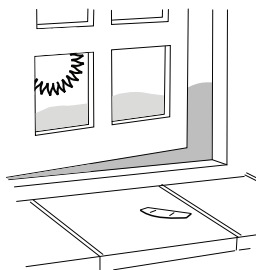

Remove excess water by shaking and leave to dry for 24 hours. Refit filters only when completely dry.

* Certain models only



IMPORTANT: For optimum cleaning performance, always keep your filters clean.

Exhaust filter

The exhaust filter should be washed every month.

HEPA exhaust filter*

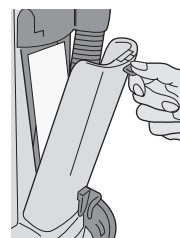

Press down on latch and remove the exhaust filter cover.

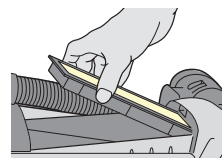

Lift out the exhaust filter.

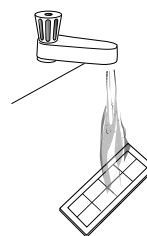

Wash filter under hand warm water.
DO NOT USE HOT WATER OR DETERGENTS!

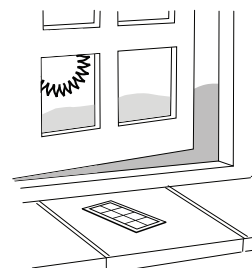

Remove excess water by shaking and leave to dry for 24 hours. Refit filters only when completely dry.

Microfilter exhaust filter*

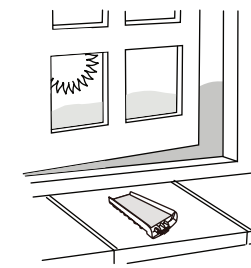
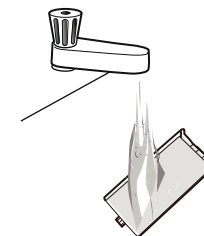
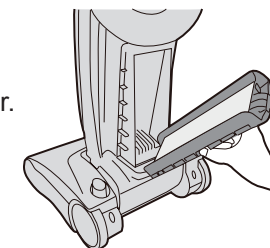

CHANGING BELT OR BRUSHES



IMPORTANT: Switch cleaner off and remove plug from electricity supply before checking the brushes or removing hood.

If your cleaner is not picking up efficiently, the belt or brushes (or both) may need replacing, but first make sure you have:

- Emptied the dust container
- Cleaned filters
- Checked for blockages

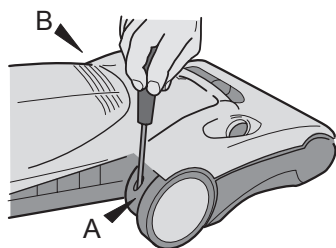

1

Remove hood

- Prise off the carpet care control selector.
- Remove hood screws A and B.
- Lift off hood.

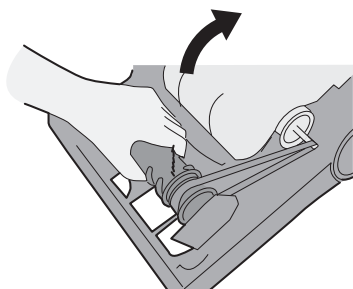

2

Remove brush assembly

- Inspect belt for signs of wear.
- To remove, pull brush cleaner assembly upwards out of cleaner housing. Remove belt from motor spindle then from brush assembly.

Replace belt

- Loop the new belt around the motor spindle then around the brush channel.

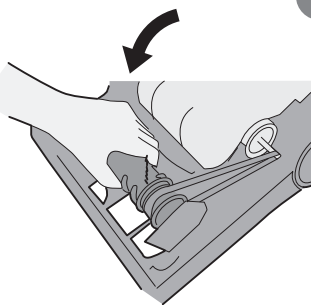

3

Refit brush assembly

- Hold the brush assembly and stretch the belt until brush mountings slot down into the cleaner housing. Rotate the brush to ensure free movement of the belt.

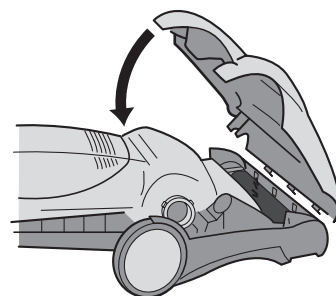

4

Refit hood

- Refit hood, ensuring the lugs along the front of hood are located in the slots along the front edge of baseplate.
- Secure hood, using screws A and B.

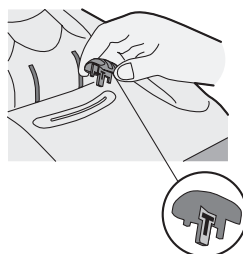

5

Refit carpet care control selector

- Ensure the raised face (T) is towards the front of the cleaner.

Removing a blockage from the Pet Hair & Allergen Remover*

Open clip and lift cover to remove blockage.

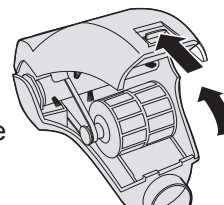

CLEARING A BLOCKAGE



IMPORTANT: Switch the cleaner off and remove the plug from the electricity supply before dismantling cleaner.

This cleaner is unlikely to become blocked, except by over filling of the dust bag or accidentally picking up large solid objects. Clearing a blockage is simple.

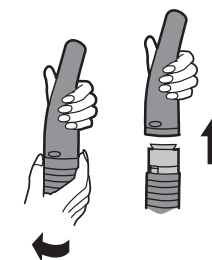

If cleaning tools were in use, check cleaning tool and extension tube first. Next check hose handgrip; to remove grip ribbed ring as shown, turn in direction of arrow and ease apart.



To check the hose, stretch it to full length and switch on the cleaner; the suction will dislodge most obstructions. If this is unsuccessful, switch off and unplug the cleaner. Remove the hose by turning it anti-clockwise as shown. Detach hose and remove blockage.

For blockages in cleaner base:

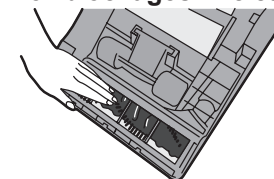

1. Turn the cleaner over and check that the brushes are free to rotate.

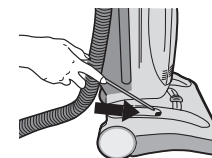

2. Check for a blockage in hose socket. Use a piece of wire or a blunt flexible rod to remove any obstructions.

* Certain models only

User checklist

If your cleaner is not working properly run through the following checklist.

1. Is there a working electricity supply to the cleaner?
Check with another electrical product.
2. Is the bag full or choked with fine dust?
To replace the bag, see the instructions on page 5.
3. Is the hose blocked?
To clear a blockage, see the instructions on page 7.
4. Is there a blockage in the cleaner base?
To clear a blockage, see the instructions on page 7.
5. Are the filters blocked?
To clear the filters, see the instructions on page 6.
6. Is the nozzle height set correctly?
To set the carpet care control selector, see the instructions on page 4.
7. Are the brushes rotating correctly?
To check the brushes, see the instructions on page 7.
8. Has the cleaner overheated?
If so, it will take about 30 minutes to reset itself.

If there is any doubt call the Hoover Service Office for advice. They may be able to assist you over the telephone. A service charge will be made if the cleaner is examined and found to be in working order, has not been assembled in accordance with these instructions or has been used incorrectly. working order, has not been assembled in accordance with these instructions or has been used incorrectly.

WARNING!

A thermal cut out switches off the cleaner to prevent overheating if it is used when full or there is a blockage or dirty filters. If this should happen switch off, unplug and correct the fault.

It will take about 45 minutes for the cut out to automatically reset.

IMPORTANT: Do not run cleaner over the supply cord as this could damage the supply cord insulation.

IMPORTANT INFORMATION

Hoover Service

Should you require service at any time, please contact your local Hoover Service Office.

Hoover spares and Consumables

Always replace parts with genuine Hoover spares. These are available from your local Hoover dealer or direct from Hoover. When ordering parts always quote your model number.

Quality

Hoover's factories have been independently assessed for quality. Our products are made using a quality system which meets the requirements of ISO 9001

GUARANTEE STATEMENT

The guarantee conditions for this appliance are as defined by our representative in the country in which it is sold. Details regarding these conditions can be obtained from the dealer from whom the appliance was purchased. The bill of sale or receipt must be produced when making any claim under the terms of this guarantee.

Subject to change without notice.



GENERATION FUTURE

Hoover Limited
Pentrebach
Merthyr Tydfil
Mid Glamorgan
CF48 4TU

HOOVER CUSTOMER HELPINE
08444 995 599

© 2014 48011634

HOOVER

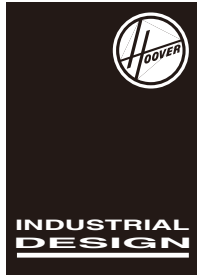

Artwork Number: Issue:

Title:
user manual & manual label

Created: Date:
Cris 2014/05/06

Modified: Date:
Cris 2014/05/06

Engineering Approved: Date:

Hoover Ltd.
Industrial Design Department
5th Floor, 288 Dongping Street,
Suzhou Industrial Park, Suzhou,
PRC 215123
Tel: 0512-82181000 Ext 226

Note:
Artwork not to be used
unless approved by
Engineering.

stick

MANUAL LABEL

Printing colour :

Size : 75x50mm 黑 (black)

Material: Adhesiver sticker (不覆膜不干胶)

Background Colour: White (白色底)



USER MANUAL

Printing colour : 黑 (black)

Size : 297x210mm

Material: 1.cover= 铜版纸 coated paper(120g)

2.inside pages= 双胶纸 offset paper(80g)