

Banbury Dining Table

Assembly Instructions - Please keep for future reference

603/3514

603/3521

632/3839

244/4248

571148

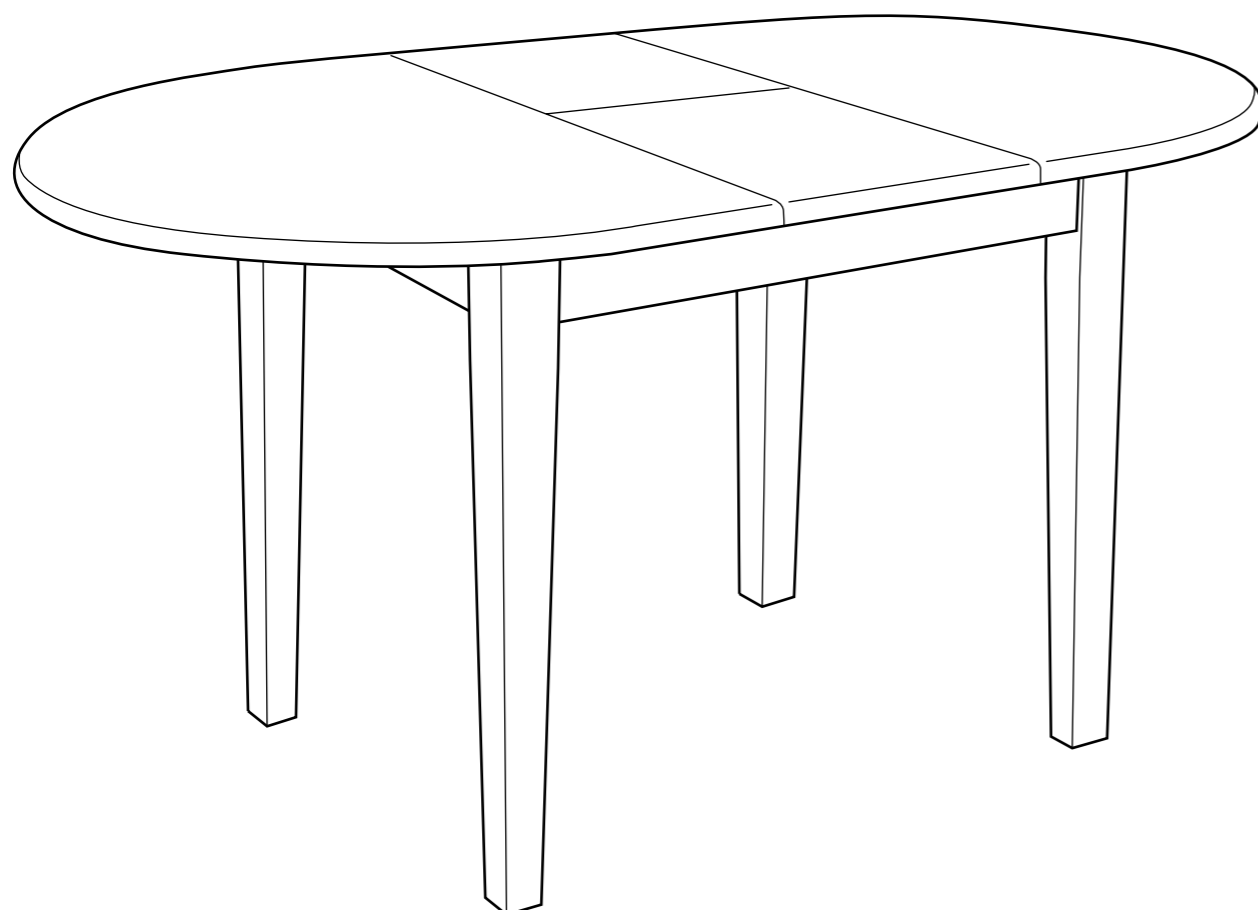

Dimensions

Width - 106/135cm

Depth - 80cm

Height - 74.2cm

Important - Please read these instructions fully before starting assembly

If you need help or have damaged or missing parts, call the **Customer Helpline: 0345 640 0800**

Safety and Care Advice

Important - Please read these instructions fully before starting assembly

- Assemble this item in the room intended for use.
- At least 2 people are required to assemble this product.
- Do not discard any of the packaging until you have checked that you have all the parts and the pack of fittings.
- Assemble this product on a flat protected surface.
- Assemble all parts loosely before tightening any bolts.
- Discard all extra fittings and keep fittings out of reach of children.
- Please note wood is a natural material, some slightly colour and grain variation and natural marks will be present.
- Unit weight: 21.3kgs.
- Dispose of all packaging carefully and responsibly.



- We do not recommend the use of power drill/drivers **for inserting screws**, as this could damage the unit. Only use hand screwdrivers.
- Retain assembly instruction for future reference.

Warnings

- This product should only be used on firm, level ground.
- Make sure the legs remain in contact with the ground.
- Do not stand on the product.

Care and maintenance

- Wood, a natural product, needs attention, general care.
- Do not lift the table when in its extended state as this may damage the table.
- Always lift the furniture when moving it around. Never drag.
- Metal parts should be cleaned with wet cloth only. Do not use abrasive cleaner.
- From time to time check that there are no loose bolts or screws on this unit.

Components - Parts

If you have damaged or missing components, call the **Customer Helpline: 0345 640 0800**

Please check you have all the parts listed below

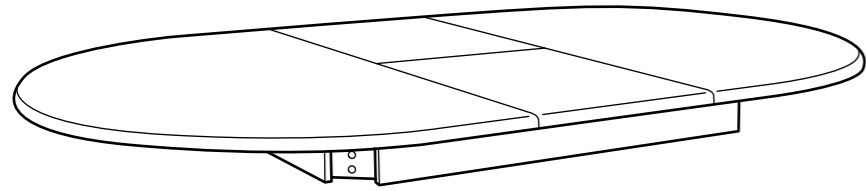

1 Table top
(106/135 x 80 x 12cm)

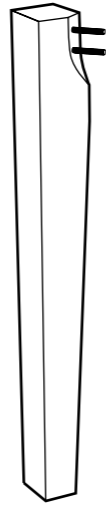



2 Leg x 4
(72 x 5.5/3.5cm)

Components - Fittings

Please check you have all the fittings listed below

Note: The quantities below are the correct amount to complete the assembly. In some cases more fittings may be supplied than are required.

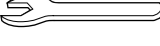
<p>A </p> <p>Nut x 8</p>	<p>B </p> <p>Spring washer x 8</p>	<p>C </p> <p>Flat washer x 8</p>
<p>D </p> <p>Spanner x 1</p>		

Assembly Instructions

Step 1

Attaching legs

Place the table top **1** on a flat protected surface.

Position the legs **2** on the table top **1** and insert the bolts on the legs into holes on the table top as shown.

Important: Remove plastic tip cover on bolts before assembling.

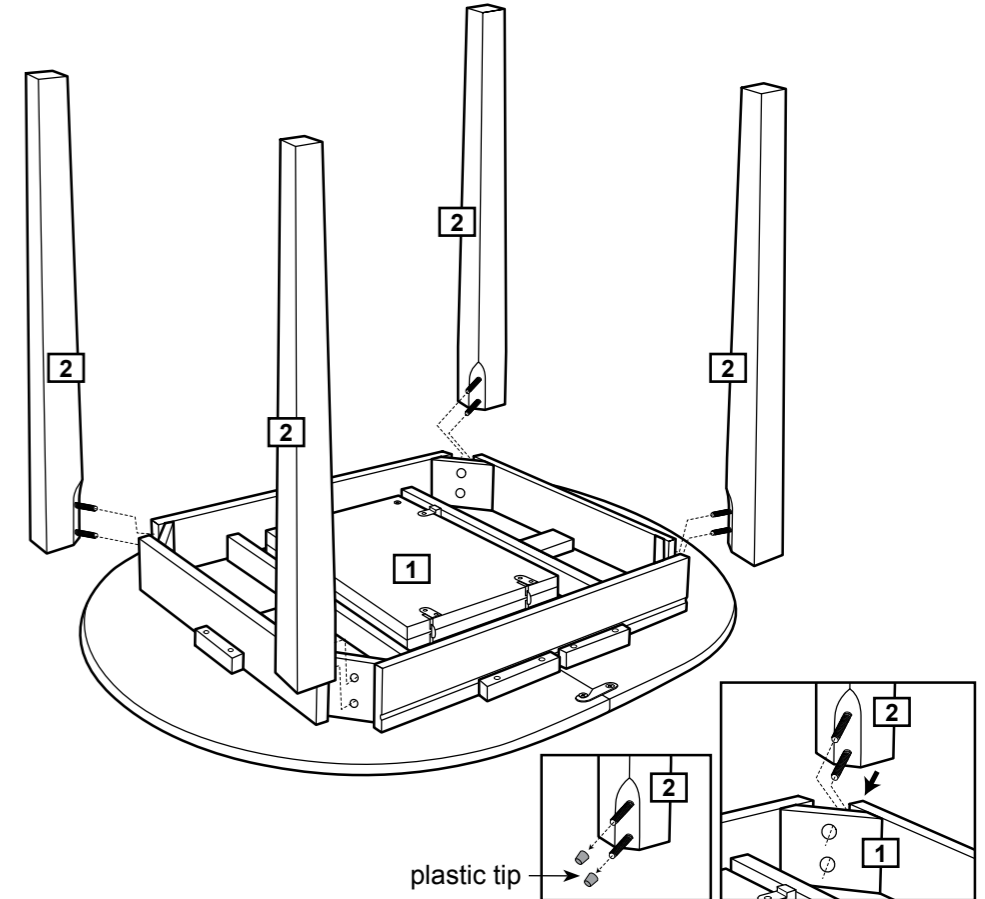

Step 2

Fixing the legs

Fix the legs **2** using nuts **A**, spring washers **B** & washers **C**.

Tighten the nuts using spanner **D**.

Carefully turn over the table by holding the legs and place on a firm surface.

Important: This is a solid wood table. At least 2 people are required to lift this table.

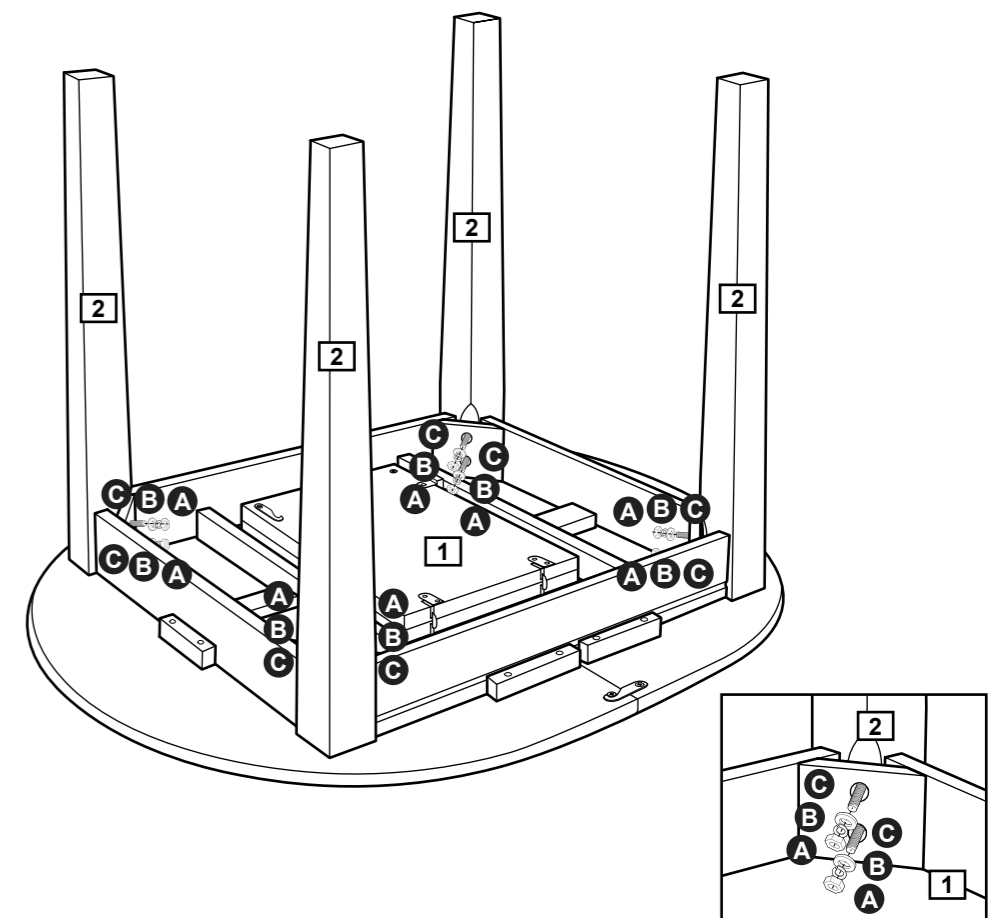

Assembly is complete.

Operation Instructions

Step 1

Extending the table

a: Release the 2 locks under the table top.

With two persons on each end of the table, carefully pull out the table top as shown.

b: Pull out the middle extension top as shown.

c: Open up the middle extension top.

d: Push the table top back in.

Firmly close the gaps by aligning and inserting the metal dowels with the holes on the edge of the table tops.

Fasten the 4 locks under the table top.

Warning: Keep hands away from gaps when adjusting table tops.

Important: Do not lift the table when in its extended state as this may damage the table.

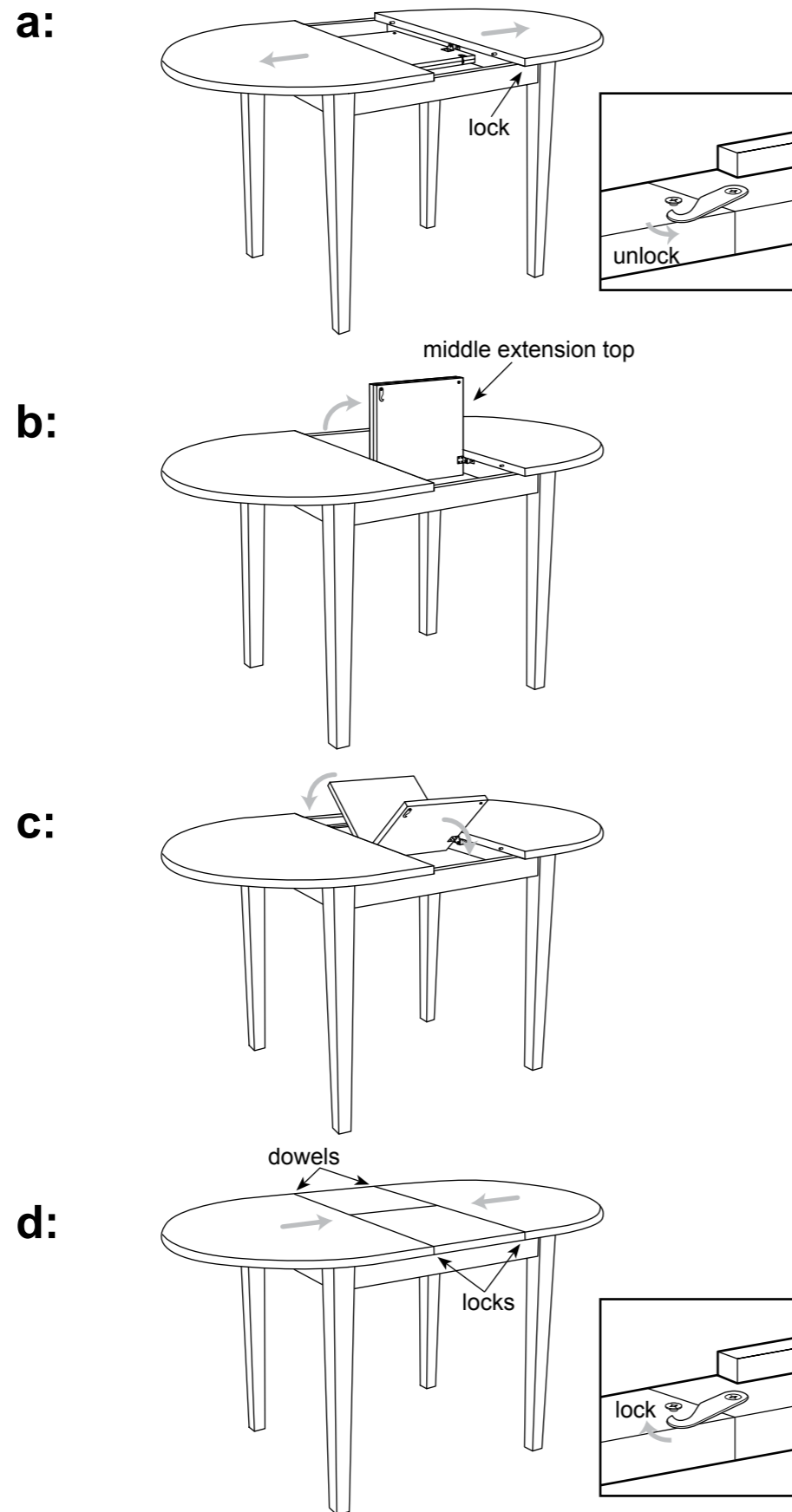

Operation Instructions

Step 2

Retracting the table

a: Release the 4 locks under the table top.

With two persons on each end of the table, carefully pull out the table top as shown.

b: Pull up the middle extension top as shown.

c: Fold down the middle extension top.

d: Push the table top back in.

Firmly close the gaps by aligning and inserting the metal dowels with the holes on the edge of the table tops.

Fasten the 2 locks under the table top.

Warning: Keep hands away from gaps when adjusting table tops.

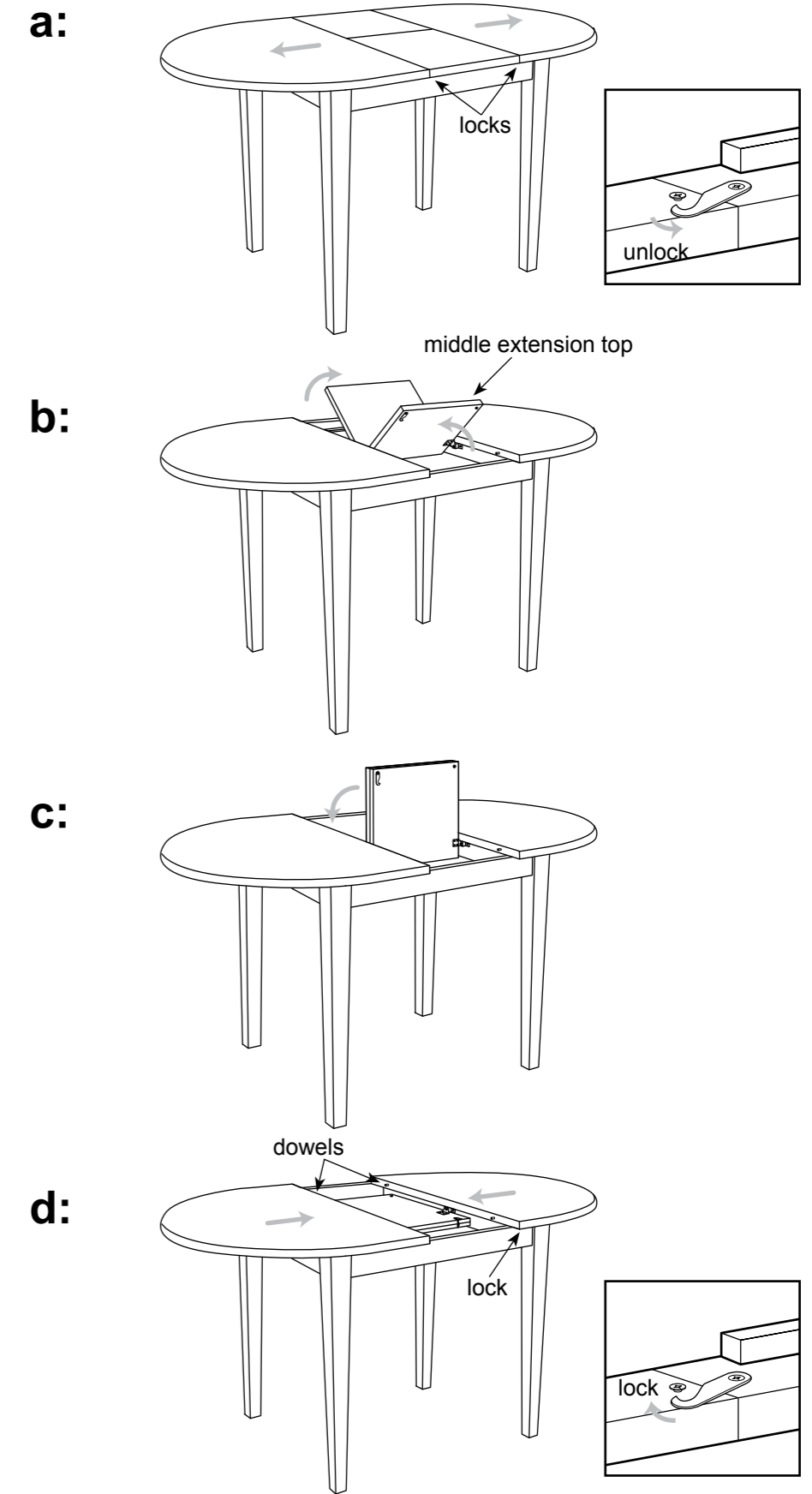

If you need help or have damaged or missing parts, call the **Customer Helpline: 0345 640 0800**