

Capella - 2 Door Robe

Assembly Instructions - Please keep for future reference

267/9965

259/9760

257/7548

228/5964

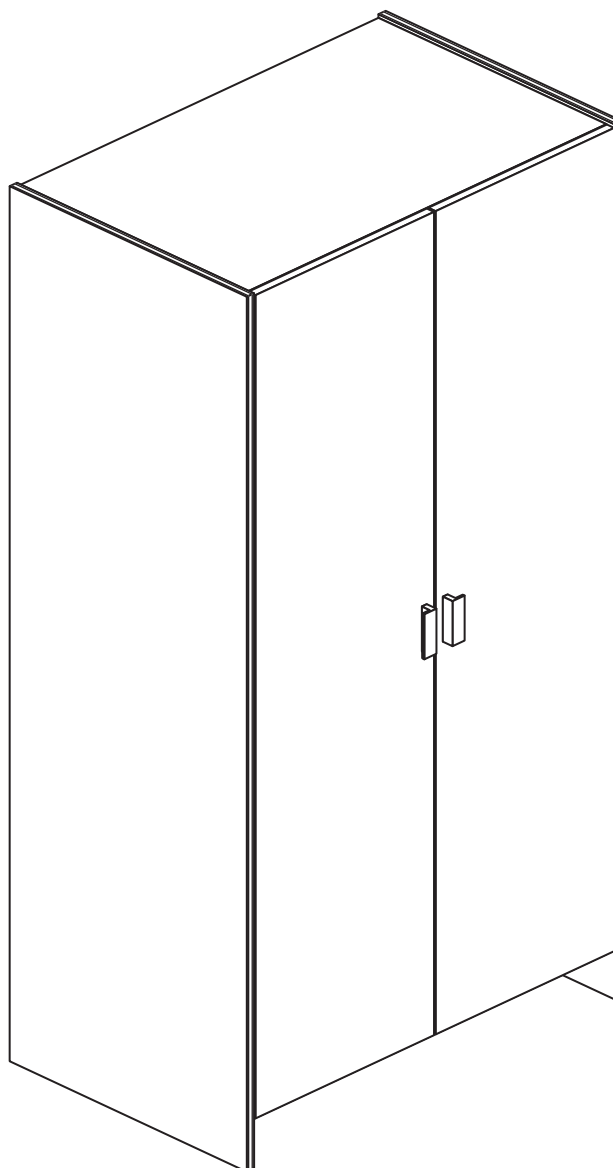

Dimensions

Width - 78cm

Depth - 49cm

Height - 181cm



**MADE IN
BRITAIN**

Important - Please read these instructions fully before starting assembly

If you need help or have damaged or missing parts, call the **Customer Helpline: 08456 400800**



Safety and Care Advice

Important - Please read these instructions fully before starting assembly

- **Warning:** This unit weighs approximately 44kgs. Please lift with care.

- Check you have all the components and tools listed on pages 2 and 3.

- Remove all fittings from the plastic bags and separate them into their groups.

- Keep children and animals away from the work area, small parts could choke if swallowed.

- Parts of the assembly will be easier with 2 people.

- Make sure you have enough space to layout the parts before starting.

- Do not stand or put weight on the product, this could cause damage.

- Assemble the item as close to its final position (in the same room) as possible.

- Assemble on a soft level surface to avoid damaging the unit or your floor (use opened out unit carton).



- We do not recommend the use of power drill/drivers **for inserting screws**, as this could damage the unit. Only use hand screwdrivers.

- **Safety note:** It is recommended that this unit is secured to a wall using the bracket supplied.

- Dispose of all packaging carefully and responsibly.

Care and maintenance

- Only clean using a damp cloth and mild detergent, do not use bleach or abrasive cleaners.

- From time to time check that there are no loose screws on this unit.

- This product should not be discarded with household waste. Take to your local authority waste disposal centre.

Note: If required the next page can be cut out and used as reference throughout the assembly. Keep this page with these instructions for future reference.

Components - Panels

If you have damaged or missing components, call the **Customer Helpline: 08456 400800** quoting the reference numbers below

Please check you have all the panels listed below

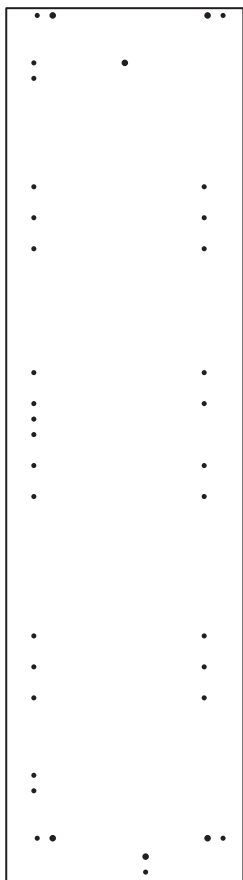

1 Left Side (D1013A)
(1808 x 490mm)

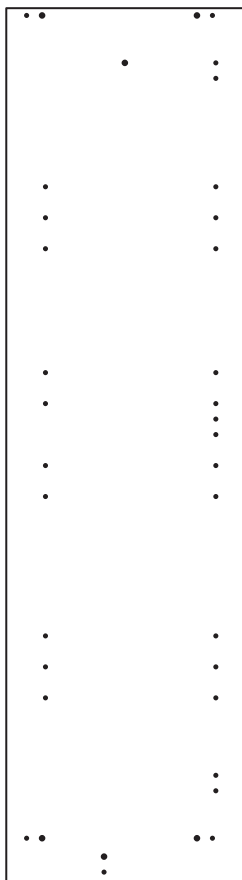

2 Right Side (D1014A)
(1808 x 490mm)



3 Top/Base (D1015A)
(747 x 471mm) x 2



4 Plinth (D1016A)
(747 x 85mm)



5 Hanging Rail (FHR737)
(737mm long)

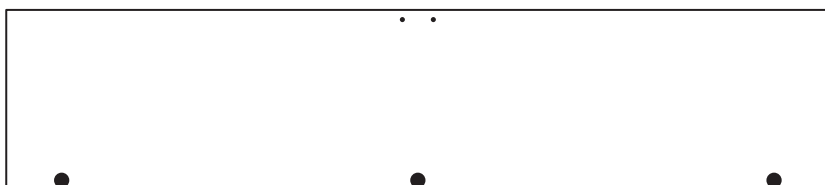

6 Door (D1017A)
(1701 x 369mm) x 2

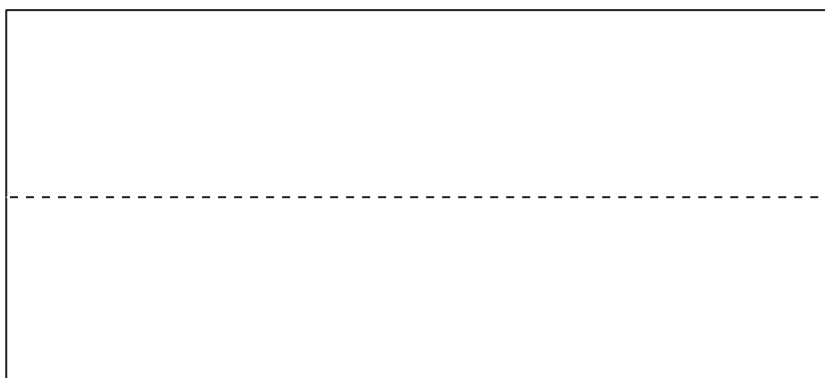

7 Back (X829A)
(1711 x 773mm)











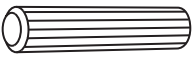
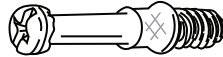
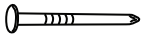

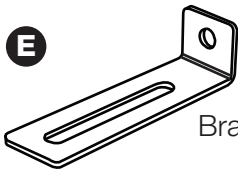
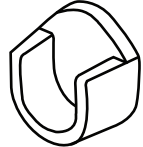
Components - Fittings



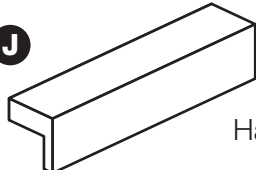

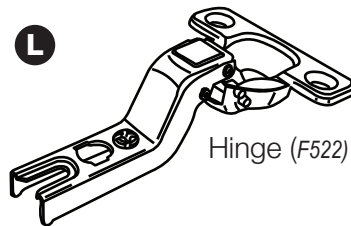

If you have damaged or missing components, call the **Customer Helpline: 08456 400800** quoting the reference numbers below

Please check you have all the fittings listed below

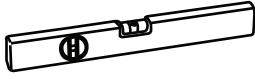
Note: The quantities below are the correct amount to complete the assembly. In some cases more fittings may be supplied than are required.

<p>A </p> <p>Wooden dowel (F22) x 10</p>	<p>B </p> <p>Metal dowel (F901) x 10</p>	<p>C </p> <p>Nail (F51) x 34</p>
<p>D </p> <p>Large locking nut (F900) x 10</p>	<p>E </p> <p>Bracket (F327) x 1</p>	<p>F </p> <p>Rail holder (F1014) x 2</p>
<p>G </p> <p>25mm Screw (F50) x 4</p>	<p>H </p> <p>13mm Screw (F79) x 1</p>	<p>I </p> <p>13mm Screw (F63) x 12</p>
<p>J </p> <p>Handle (F930) x 2</p>	<p>K </p> <p>Hinge plate (F523) x 6</p>	<p>L </p> <p>Hinge (F522) x 6</p>
<p>M </p> <p>Plastic Nail (F91) x 4</p>		

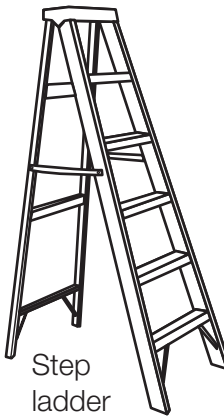
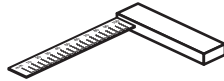
Tools required

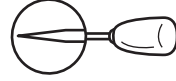
<p></p> <p>Rule</p>	<p></p> <p>Spirit level</p>	<p></p> <p>Eye protection (when using a hammer or drill)</p>	<p></p> <p>Cross-head screwdriver</p>	<p></p> <p>Electric drill (only use when drilling into walls)</p>	<p></p> <p>Step ladder</p>
<p></p> <p>Square</p>	<p></p> <p>Scissors</p>	<p></p> <p>Hammer</p>	<p></p> <p>Bradawl</p>		

Ruler - Use this ruler to help correctly identify the screws

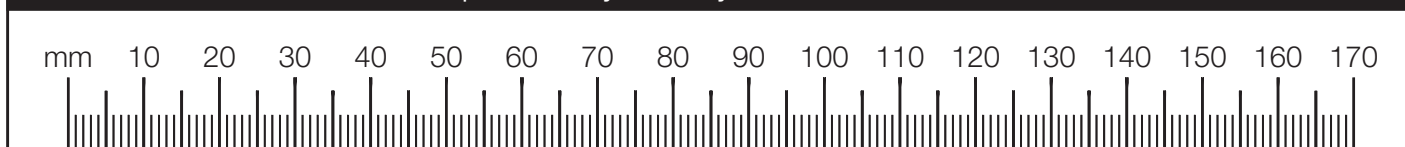

Assembly Instructions

If you have damaged or missing components, call the
Customer Helpline: 08456 400800 quoting the reference
numbers below

Step 1

Prepare the left side

Fit 3 hinge plates **K** onto the left side **1**, making sure that the slot is facing towards the finished front edge.

Screw 5 metal dowels **B** into the left side **1**.

Note: Tighten the metal dowels up fully against the panels.

Push a rail holder **F** into the left side **1**. Make sure that it is fitted straight, in line with the panel edges.

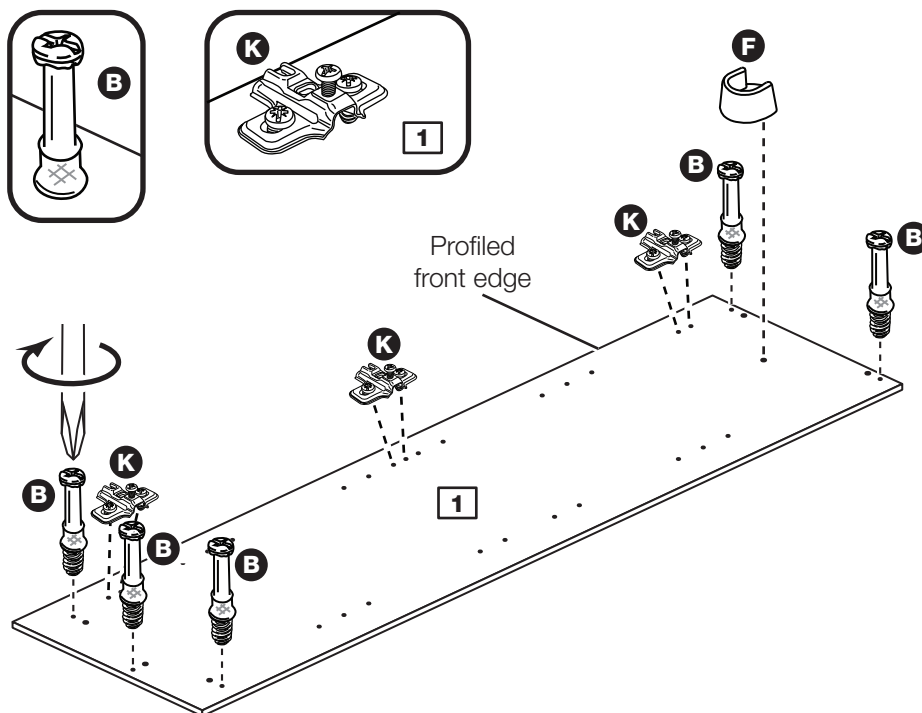

Step 2

Prepare the right side

Fit 3 hinge plates **K** onto the right side **2**, making sure that the slot is facing towards the finished front edge.

Screw 5 metal dowels **B** into the right side **2**.

Note: Tighten the metal dowels up fully against the panels.

Push a rail holder **F** into the right side **2**. Make sure that it is fitted straight, in line with the panel edges.

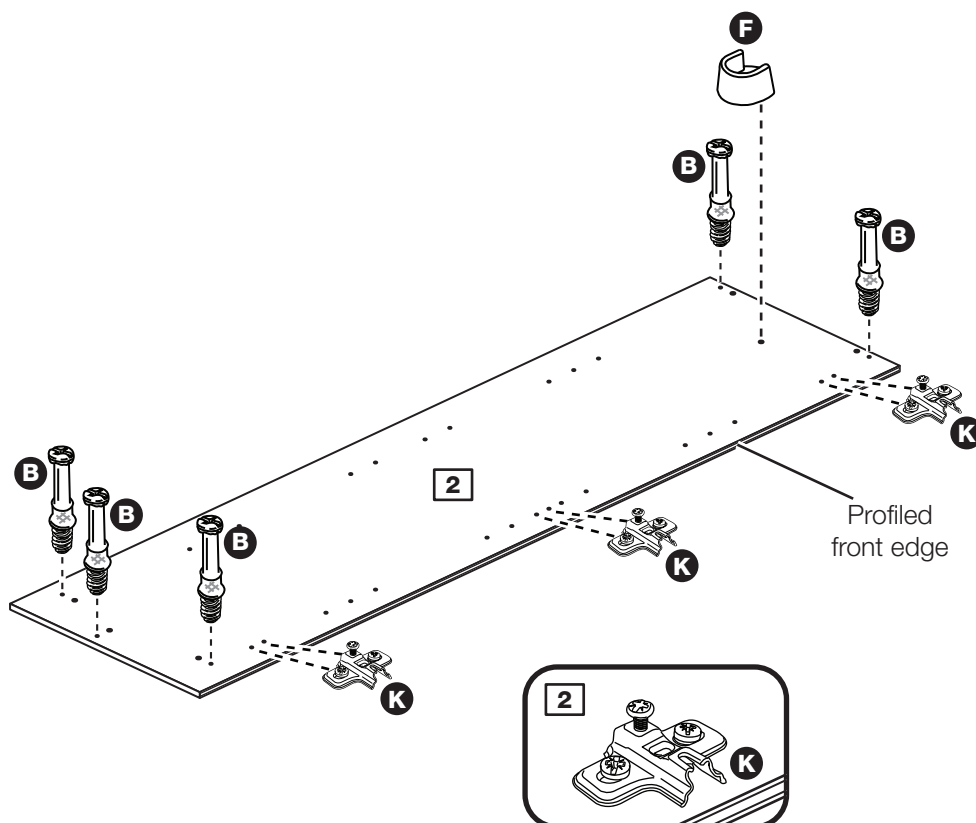

Assembly Instructions

Step 3

Prepare the top and base

Tap 4 wooden dowels **A** into the top **3** and base **3** as shown.

Note: Wooden dowels **must not** stick out from the edge by more than 10mm or they may damage other panels.

Insert 4 large locking nuts **D** into the top **3** and base **3** as shown.

Note: The arrow on the locking nut **must** point towards the hole in the edge of the panel.

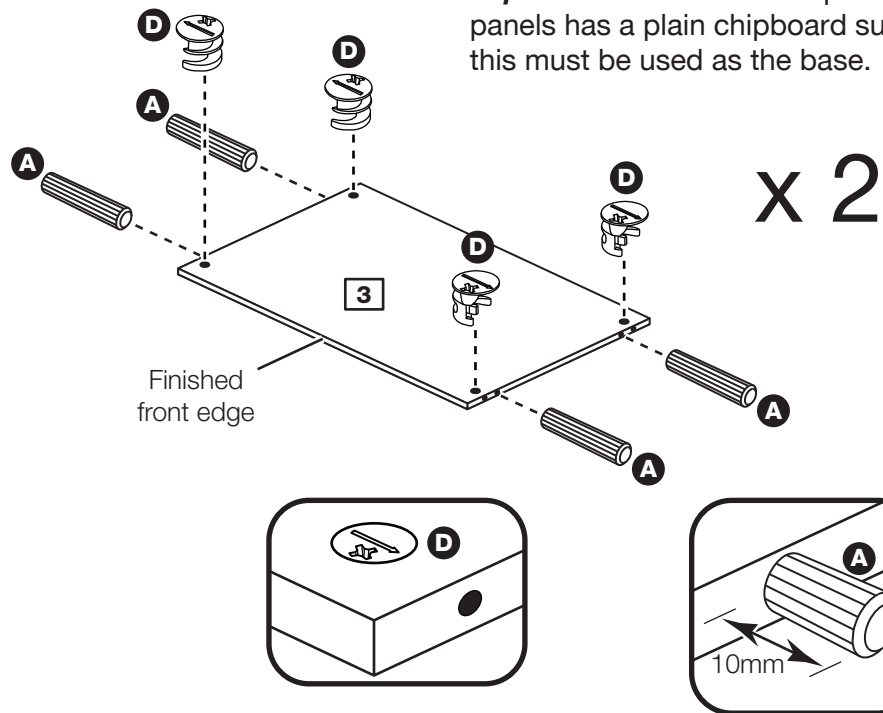

Step 4

Fit the top and base to the right side

Push the top **3** and base **3** onto the right side **2** as shown.

Use a screwdriver to tighten the 4 large locking nuts **D** fitted to the top **3** and base **3**.

Note: Turn the large locking nuts **D** as far as they will go - more than 1/2 a turn.

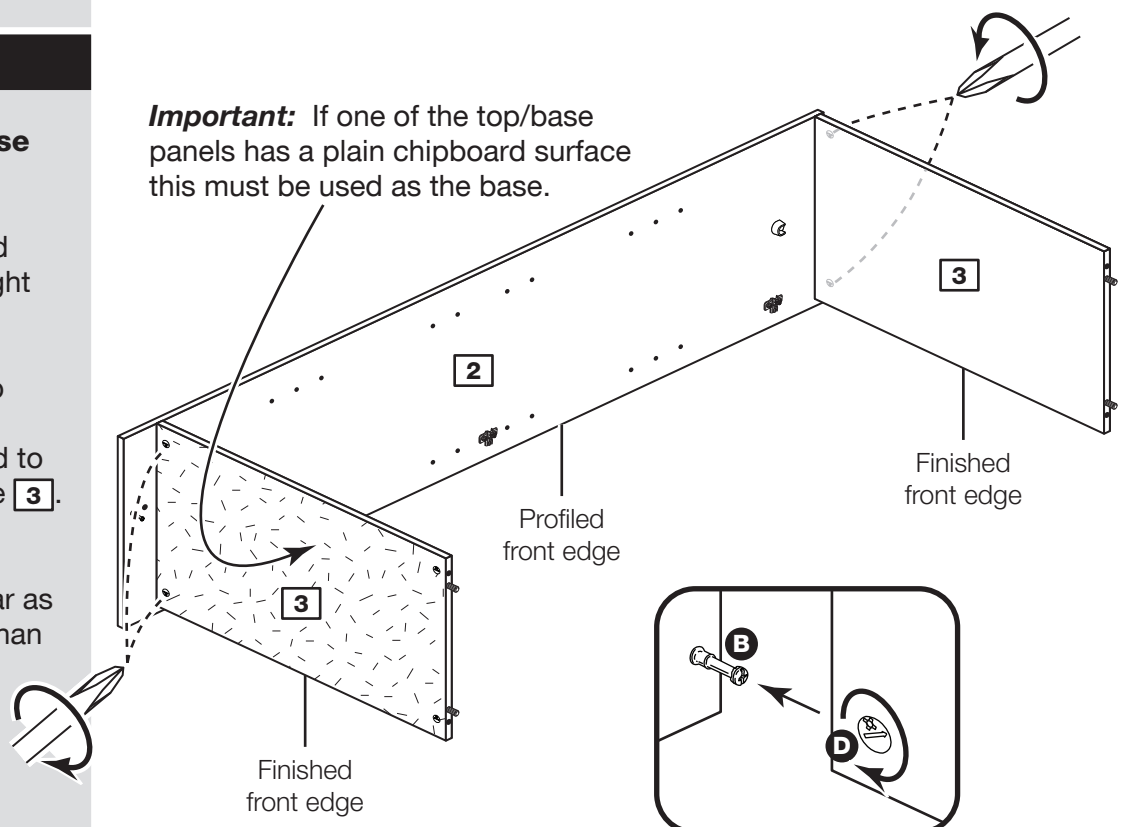

Assembly Instructions

Step 5

Prepare the plinth

Tap 2 wooden dowels **A** into the plinth **4**.

Insert 2 large locking nuts **D** into the plinth **4**.

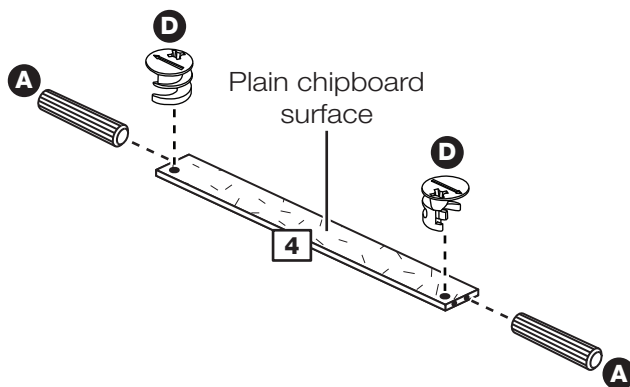

Step 6

Fit the plinth

Push the plinth **4** onto the right side **2** as shown.

Use a screwdriver to tighten the large locking nut **D** fitted to the plinth **4**.

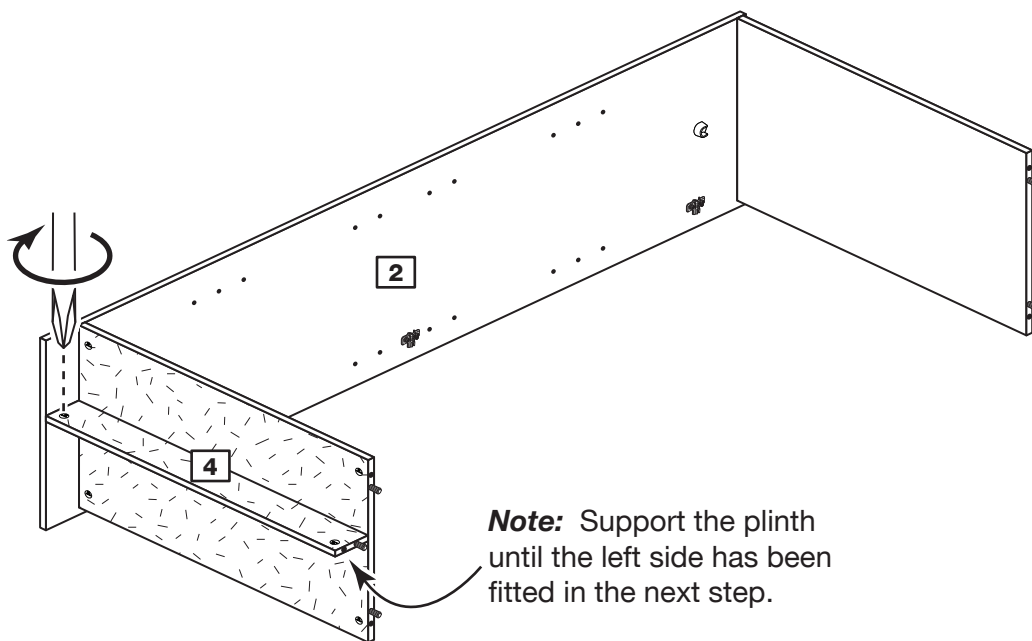

Step 7

Fit the left side

Push the left side **1** onto the assembly.

Use a screwdriver to tighten the 5 large locking nuts **D** fitted to the top **3**, base **3** and plinth **4**.

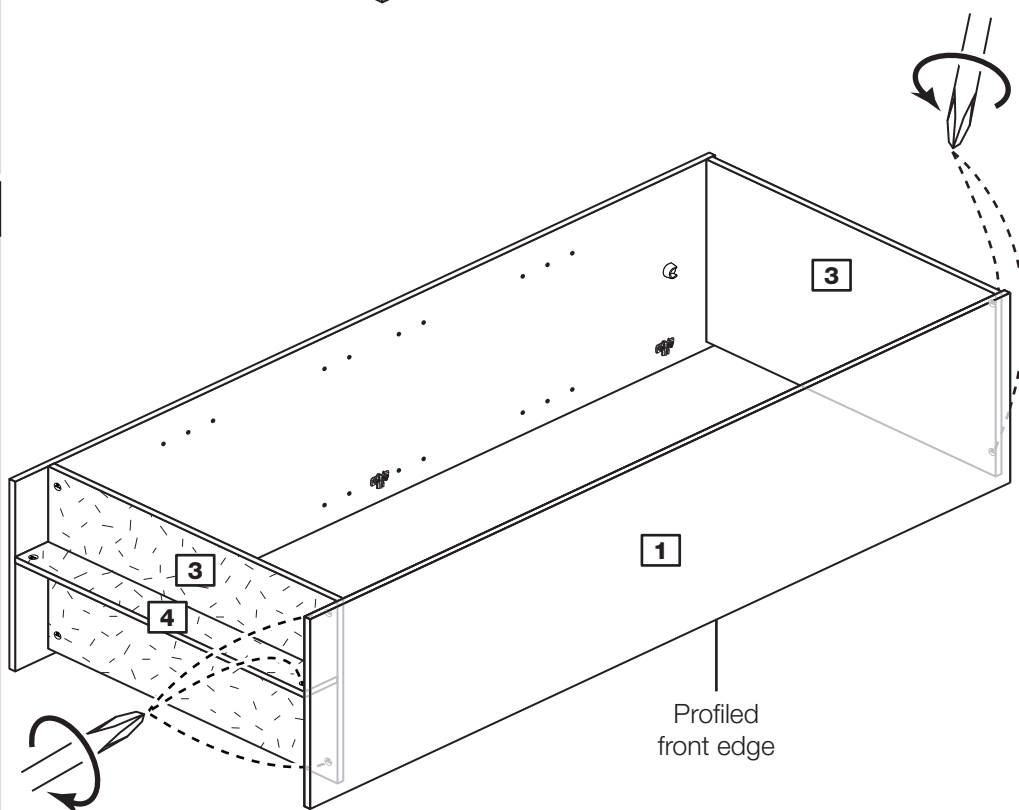

Assembly Instructions

Step 8

Fit the back

a: Square up the unit by making sure that measurement **x to x** equals **y to y**.

b: Place the back **7** onto the unit.

Nail **C** around the outside edges of the back **7**.

Note: Nails should be spaced about 150mm apart.

a: The measurement from top corner X to bottom corner X must be equal to the measurement from top corner Y to bottom corner Y

b:

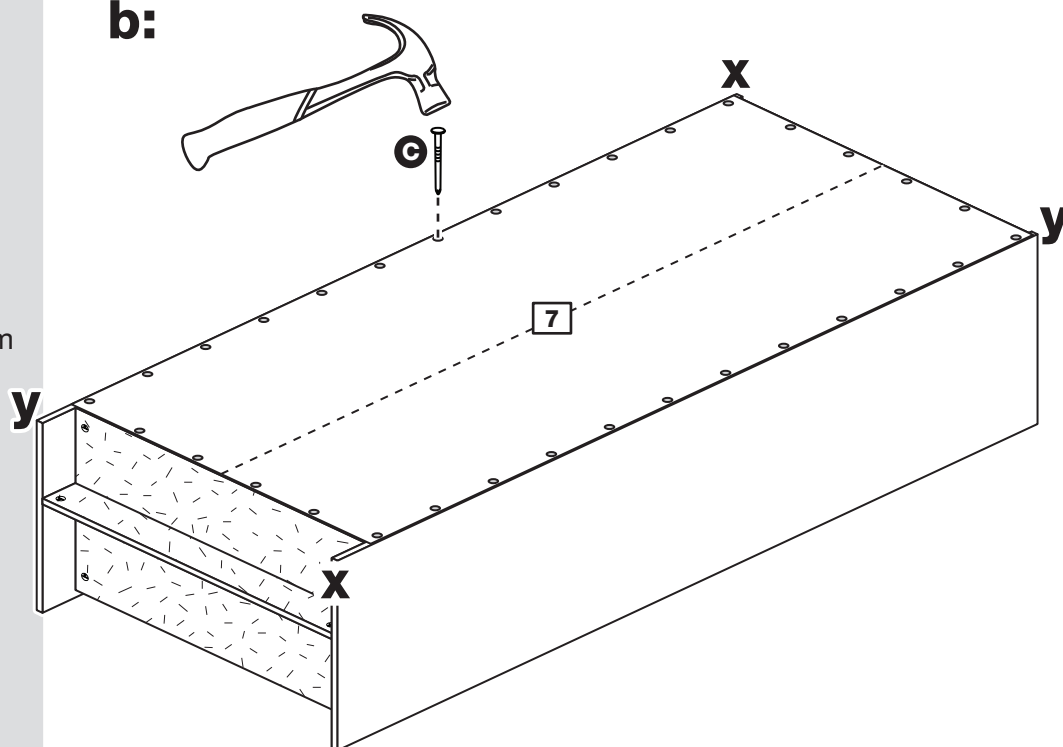

Step 9

Fit the 4 plastic nails

Tap 2 plastic nails **M** into the bottom edge of each of the sides **1** and **2**.

Stand the unit up for the next step.

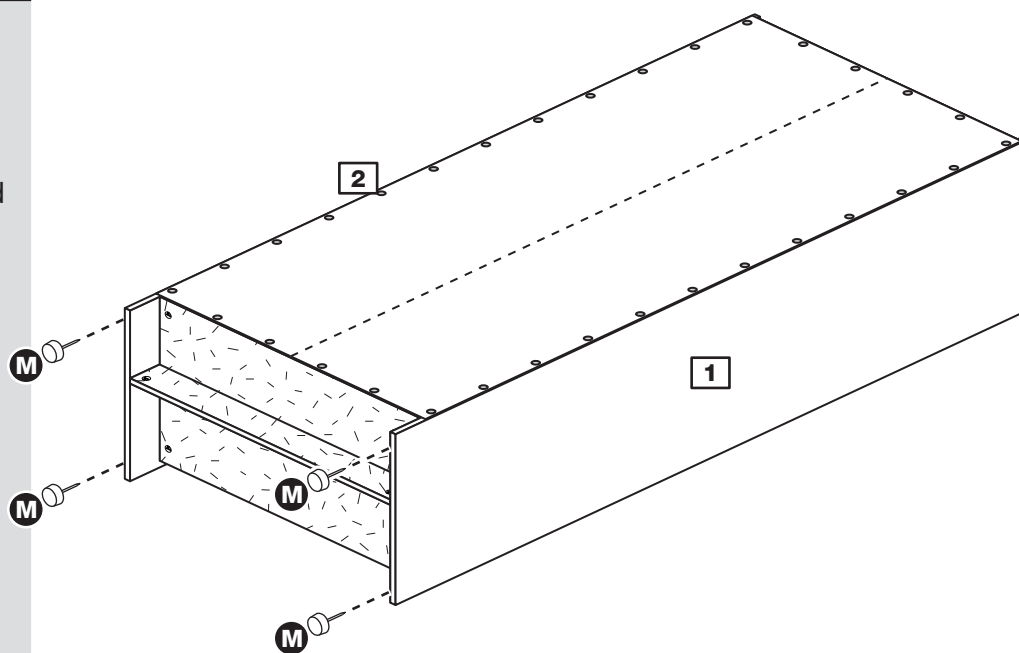

Warning: The unit is heavy. Lift with care.

Assembly Instructions

Step 10

Fit the hanging rail

Push the hanging rail **5** into the rail holders **F** fitted to the side panels.

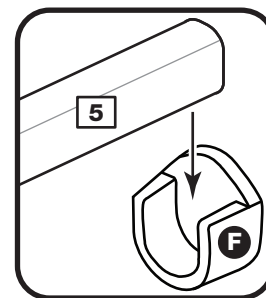
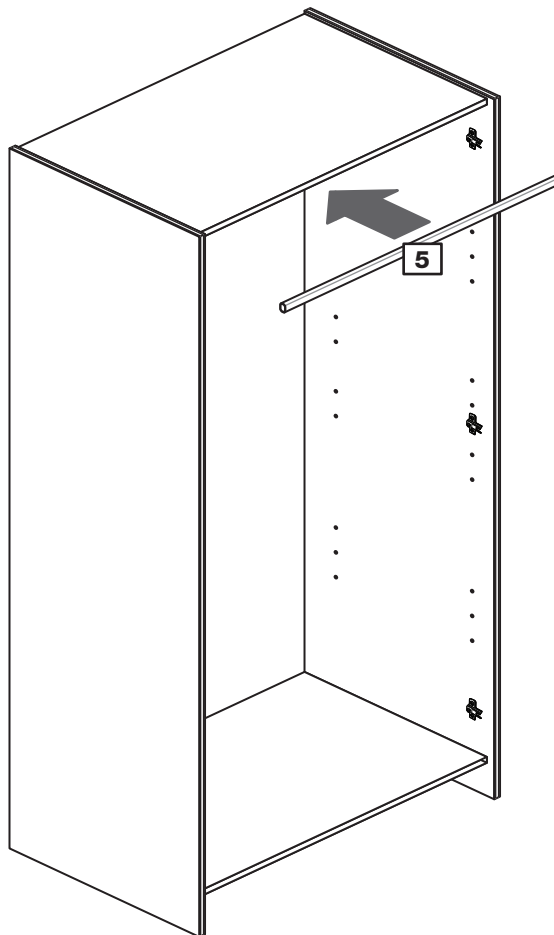

Step 11

Prepare the doors

Push fit 3 hinges **L** into each door **6**.

Secure each hinge with 2 screws **I**.

Note: Before securing with the screws, make sure that the hinges are positioned at 90 degrees with the edge of the door.

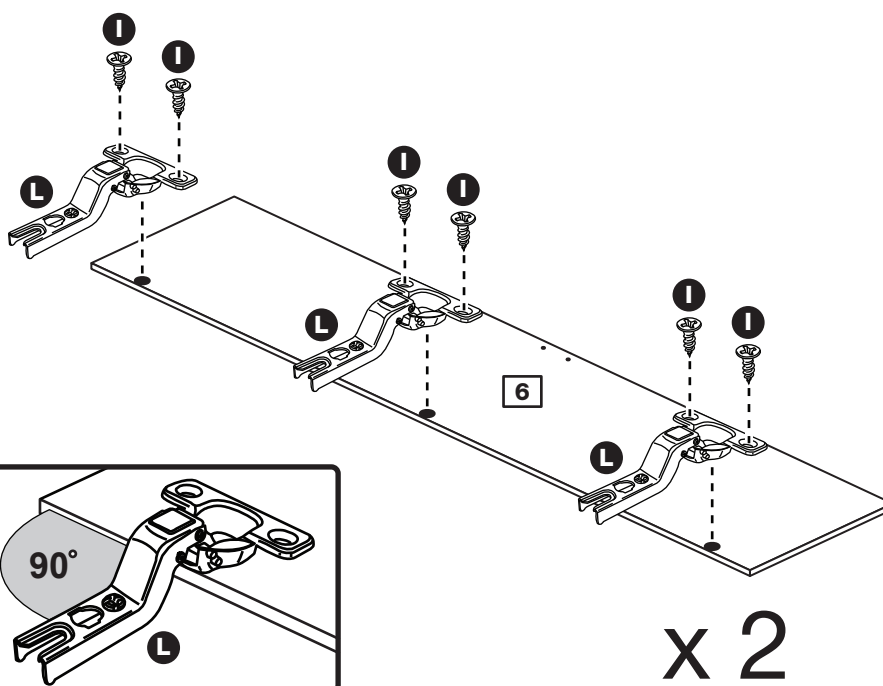

Assembly Instructions

Step 12

Fit doors and handles

Note: The easiest way to attach each door **6** is to fit the top hinge first, then align and fit the other hinges.

a: Push the hinge **L** onto the front part of the hinge plate **K**. The recess at the bottom of screw **B** goes into the slot in the hinge plate.

b: Keep the hinge **L** FLAT against the hinge plate **K** as you slide it across as far as it will go. Tighten screw **A**.

c: The hinge **L** must be flat against the hinge plate **K** prior to any adjustment.

d: The hinge **L** must NOT be AT AN ANGLE to the hinge plate **K** when assembled. This would indicate that the recess at the bottom of screw **B** had not located in the slot in the hinge plate and the hinge would not be secure. Remove the hinge from the hinge plate and then re-assemble being careful to follow instructions a-c.

e: Attach a handle **J** to each door **6** using 2 screws **G**.

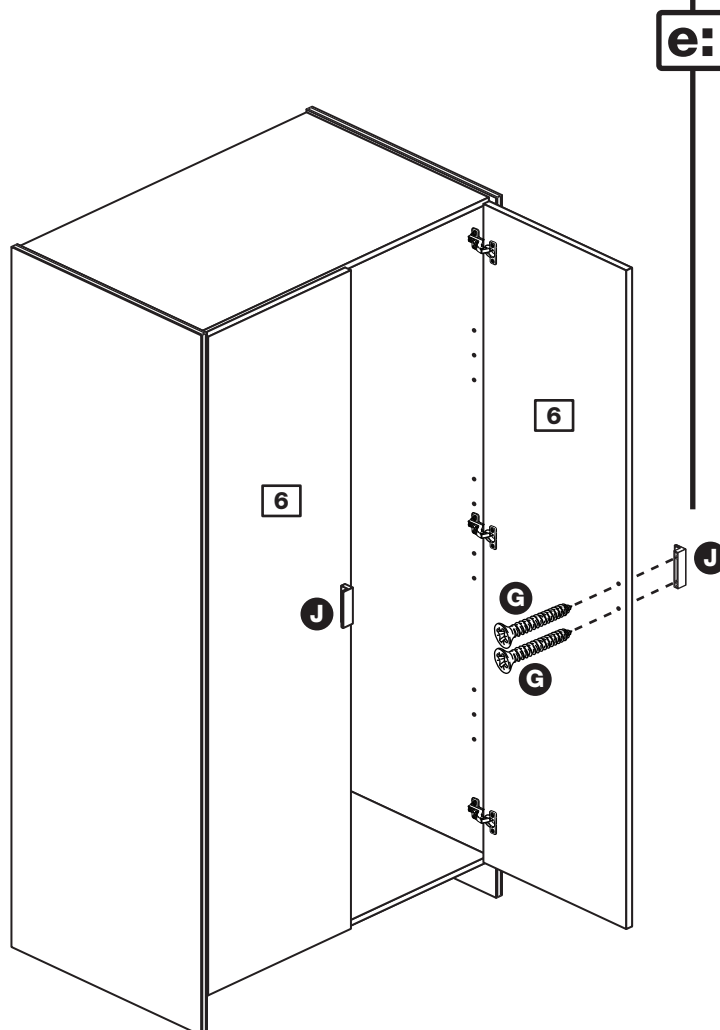
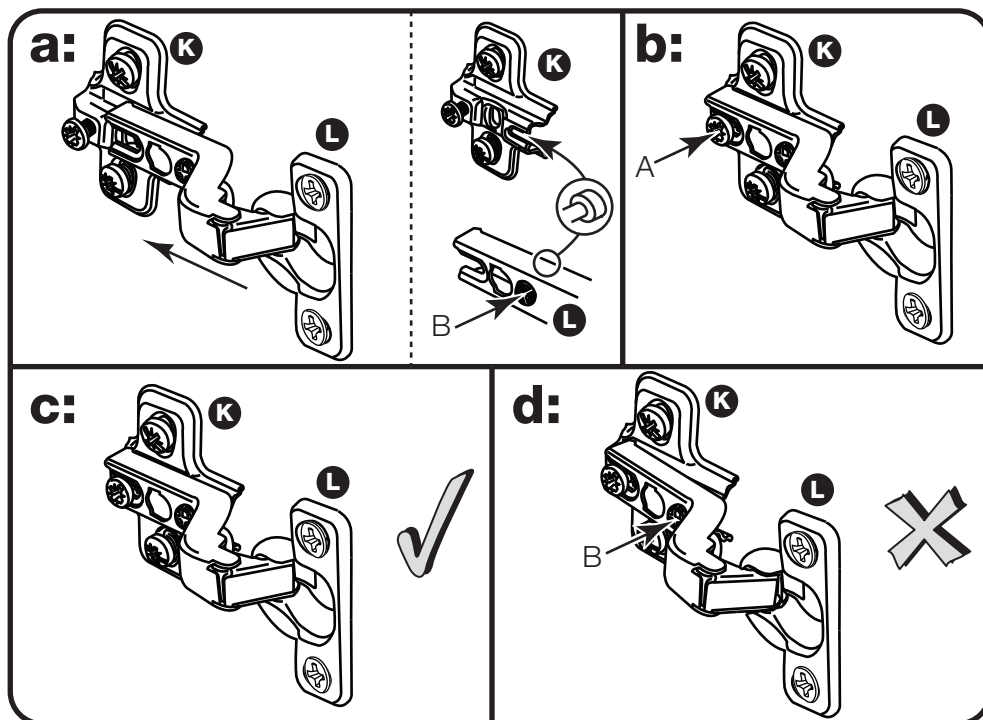

Assembly Instructions

Step 13

Adjust the doors if needed

a: Before adjusting the doors, use a spirit level to check the base (or top) of the unit is level, front-to-back and side-to-side in the 3 positions shown. Use suitable packing pieces (not supplied) to make the unit level BEFORE making any adjustment to the hinges, as shown.

b: Height adjustment.

Loosen screws A on hinge plates and move door up or down as required. Retighten screw A.

c: Forward and Back adjustment.

Loosen screw B on hinge plate and move door in or out as required. Retighten screw B.

d: Sideways adjustment.

To move door 'out' loosen screw C. To move door 'in' tighten screw C.

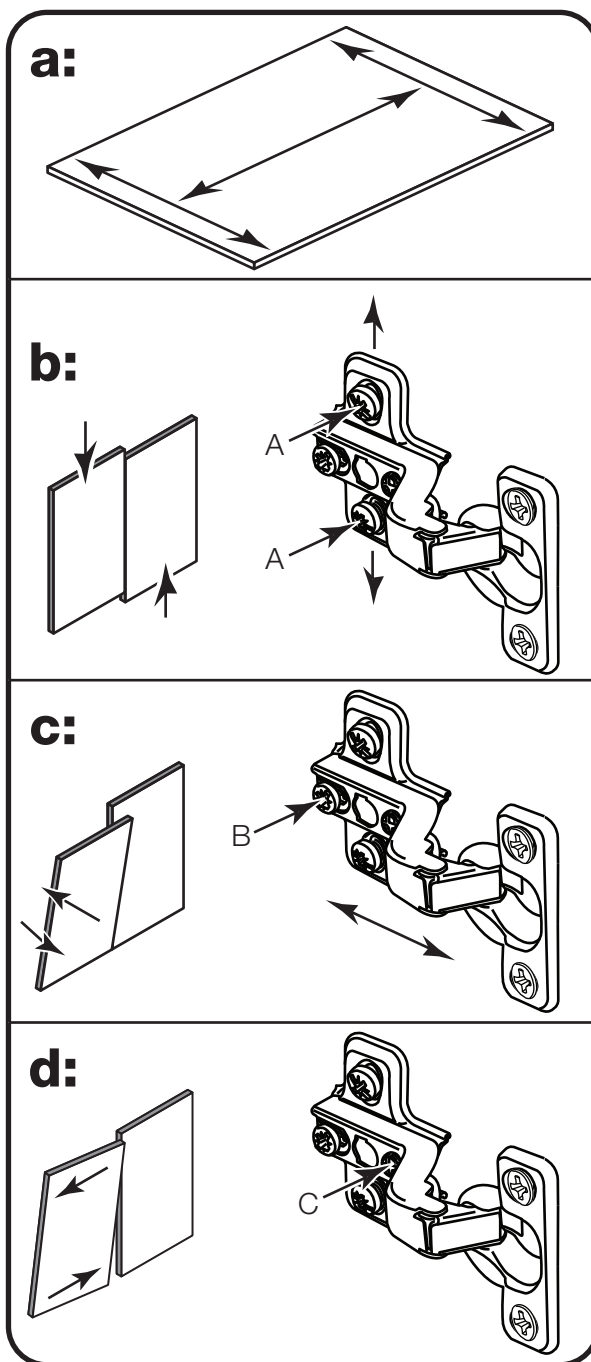

Assembly Instructions

Step 14

Fit the bracket

To prevent possible overbalancing, we recommend that this unit is secured to a suitable wall by use of the bracket **E** fitted to the top of the unit.

Fixings are not supplied, as they will need to suit the wall type and the length of screw will depend on the distance from the back of the unit to the wall.

Fix the bracket **E** loosely onto the top of the unit using screw **H** and mark the wall for the wall fixing.

Swivel the bracket **E** away from the wall and drill a hole in the wall using a suitable drill bit and fit your wall fixing.

Swivel the bracket **E** back and fix the bracket to the wall, then tighten Screw **H**.

Note: Take care when drilling the wall that you do not drill into any pipes, wires etc. If in doubt, consult an expert.



Warning: The unit is heavy. Lift with care.

Assembly is complete

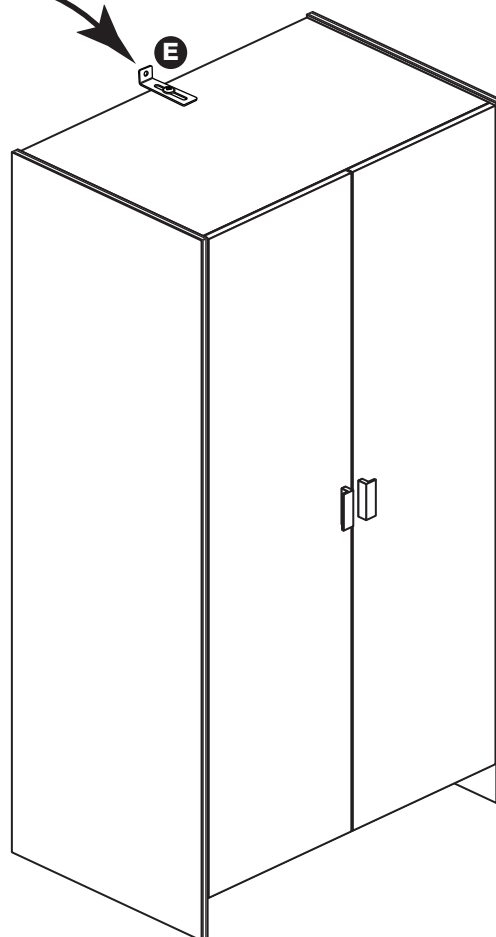
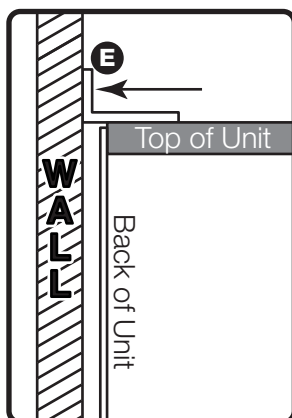
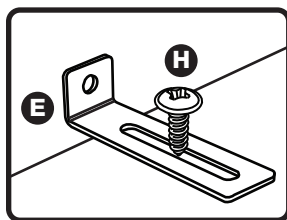

If you need help or have damaged or missing parts, call the Customer Helpline: 08456 400800 and quote the reference numbers on the component pages.

Argos Ltd, 489-499 Avebury Boulevard, Central Milton Keynes, MK9 2NW