

VC732000 MUK Rev1

morphy richards®



Supervac

2-in-1 Cordless Bagless Upright Vacuum Cleaner

Please read and keep these instructions for future use

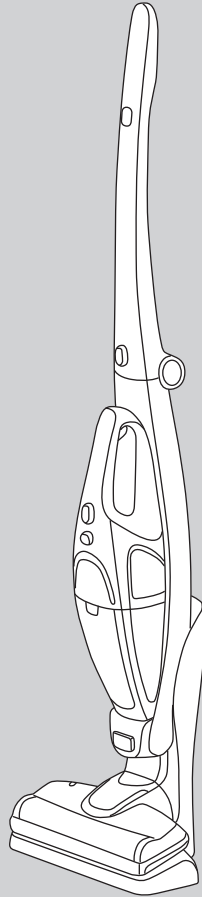

For competitions, product hints and tips and more join us at



www.morphyrichards.co.uk/blog



www.facebook.com/morphyrichardsuk



[@loveyourmorphy](https://twitter.com/loveyourmorphy)

www.morphyrichards.com

* Register online for your 2 year guarantee. See back of this instruction book for details. (UK and Ireland customers only)

Health and Safety

The use of any electrical appliance requires the following common sense safety rules.

Please read these instructions carefully before using the product.

- **WARNING: Whenever the cleaner is in use, due to the risk of entrapment in rotating parts, keep loose clothing, hair, fingers etc. away from the brush bar, nozzle and any handheld accessories.**
- **WARNING: Disconnect from the mains supply and remove the handheld vacuum cleaner (12) before carrying out any routine maintenance, such as cleaning any blockages, changing any filters or accessing the floor nozzle.**
- This appliance can be used by children aged from 8 years and above and persons with reduced physical, sensory or mental capabilities, or lack of experience and knowledge, if they have been given supervision or instruction concerning the use of the appliance in a safe way and understand the hazards involved.
- Children shall not play with the appliance.
- Cleaning and user maintenance shall not be undertaken by children without supervision.

Personal safety

- **WARNING: Only lift the product by the upright handle (4) and never pick the cleaner up by the floor nozzle.**
- To prevent accidental contact with the rotating brush, always remove the handheld unit before fitting, removing or cleaning the motorised floor brush (19).
- Never use in the presence of explosive liquid or vapours.
- Never pick up inflammable or poisonous liquids such as petrol, copier toner or other volatile substances. Never pick up acids, asbestos or asbestos dust.
- Never touch the adaptor, product or cable with wet hands.
- Unprofessional repairs can be dangerous for users.
- To protect against fire, electric shock and personal injury, do not immerse cord, plug, charging cradle or cleaner in water or other liquid.
- The appliance must never be left running unsupervised.

Location

- Do not use or keep this product outside.

- Do not store the appliance near hot surfaces eg. ovens or heating appliances.

Product safety

- This appliance is not intended for liquid/wet pick up.
- Never use the appliance without the filter being installed.
- Never use the appliance to vacuum hot ashes, broken glass, sharp objects or liquids.
- Never modify the cleaner in any way.
- Use only Morphy Richards spare parts and accessories.

Electrical requirements

- Check that the voltage on the rating plate of the charging adaptor corresponds with your house electricity supply which must be A.C. (Alternating Current).
- Only use the charging cradle (15) supplied with the unit.
- The battery is not a serviceable item. It should only be removed at the end of the product's life for recycling.
- Should the fuse in the mains plug require changing, a 3 amp BS1363 fuse must be fitted.

Contents

Health and safety	2
Electrical requirements	2
Product overview / Features	4
Dual functionality	5
Upright vacuuming: assembly	5
Charging	6
Using in upright mode	6
Handheld vacuum cleaning	7
Using the attachments on the handheld vacuum cleaner	7
Tool storage	8
Emptying the dust canister	8
Maintenance	8
Maintenance - filter	8-9
Maintenance - trouble shooting	9
Storage	9
Disposal	10
Contact us	10
Notes	10-11
Guarantee	12

Product overview

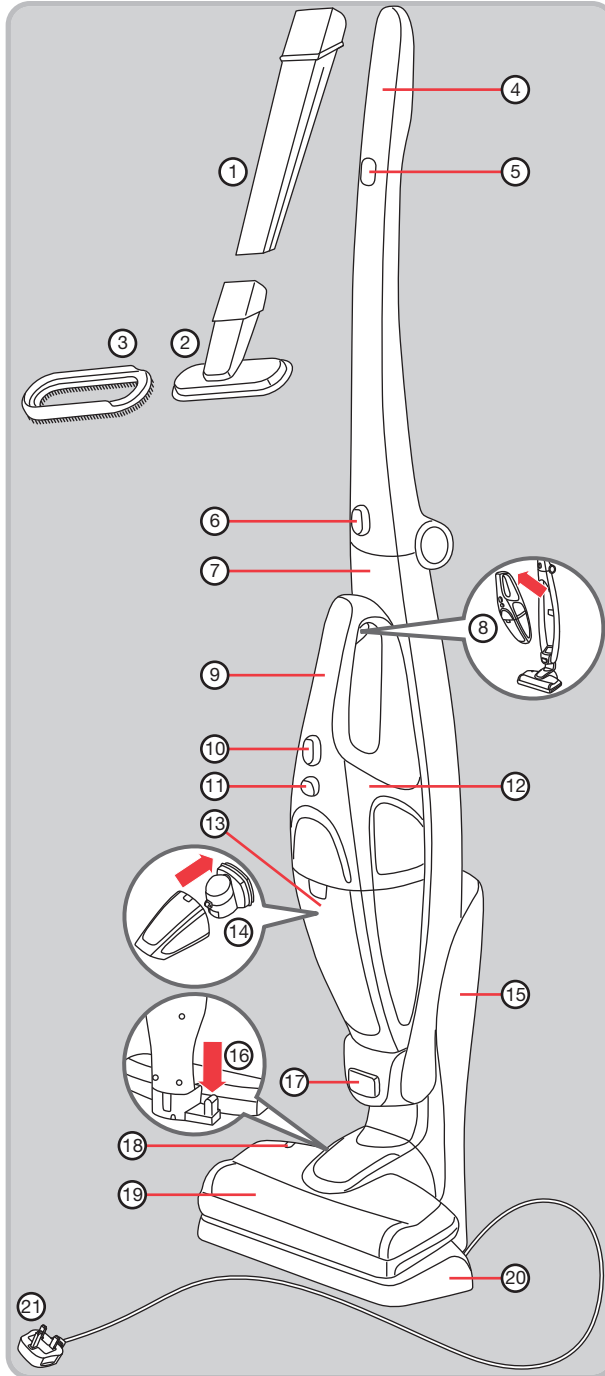

Features

- (1) Crevice tool
- (2) Upholstery nozzle
- (3) Dusting brush (attaches to upholstery nozzle (2))
- (4) Upright handle
- (5) Upright On/Off button
- (6) Upright handle release button
- (7) Main vacuum cleaner body
- (8) Handheld vacuum cleaner release button
- (9) Handheld vacuum cleaner handle
- (10) Handheld vacuum cleaner On/Off button
- (11) Dust canister release button and charging / power indicator light
- (12) Handheld vacuum cleaner
- (13) Dust canister
- (14) Dust canister filter
- (15) Charging cradle
- (16) Accessory holder
- (17) Floor brush release button
- (18) Floor brush power indicator light
- (19) Motorised floor brush
- (20) Charging cradle base
- (21) Mains plug

Dual functionality

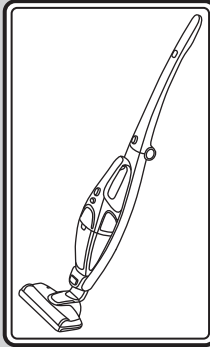

Upright vacuuming

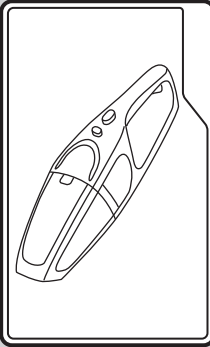

Handheld vacuum cleaner

Your vacuum cleaner can easily be configured into two different cleaning modes:

- Upright vacuum cleaner for floors and carpets.
- Handheld vacuum cleaner (12) which can be carried with you whilst cleaning hard to reach places.

Upright vacuuming: assembly

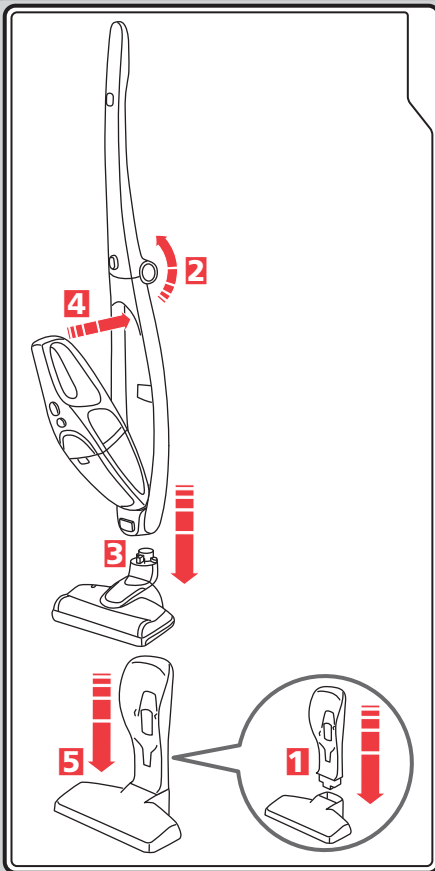

- 1 Assemble the charging cradle (15) onto the charging cradle base (20). Securely click it into place.

Place the assembled charging cradle on a flat, stable surface.

- 2 Swing the upright handle (4) on the main vacuum cleaner upwards until it clicks into place in an upright position.

- 3 Place the motorised floor brush (19) on a level surface and align the connector on the neck of the motorised floor brush with the connector hole on the base of the main vacuum cleaner body (7).

Holding the neck of the motorised floor brush in place, lower the main vacuum cleaner body onto the motorised floor brush until you hear the two pieces click into place.

When attaching the motorised floor brush, ensure that the latching mechanism is fully locked in place to ensure electrical connection is made.

- 4 Fit the handheld vacuum cleaner (12) into the cavity on the main vacuum cleaner body by firstly sliding the suction end into place over the suction hole in the main vacuum cleaner body cavity, then push the handle end in to place until a click is heard.

- 5 With the handheld vacuum cleaner in place on the main vacuum cleaner body, insert the vacuum cleaner into the charging cradle, ensuring that the lip on the rear of the main vacuum cleaner body hooks onto the notch on the concave section of the charging cradle.

Charging

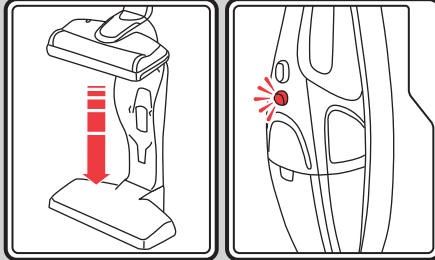

Connect the mains plug (21) into the mains supply.

Locate the vacuum cleaner on to the charging cradle (15). The indicator light (11) will glow red whilst charging and turn green when fully charged. A full charge may take 5 hours.

When fully charged, the battery will stay charged for many days, however, we recommend leaving the cleaner continuously on trickle charge so the batteries are always full.

Using in upright mode

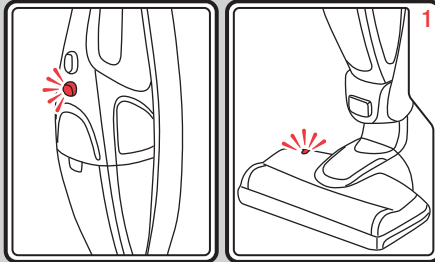

Turn the product On by using either the upright On/Off button (5) or the handheld vacuum cleaner On/Off button (10).

The handheld vacuum cleaner power indicator light (11) and the floor brush power indicator light (18) will illuminate green.

NOTE: When the battery reduces to a pre-set level the product will stop, the light will extinguish and the product must be recharged.

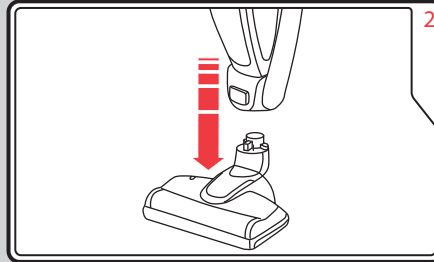

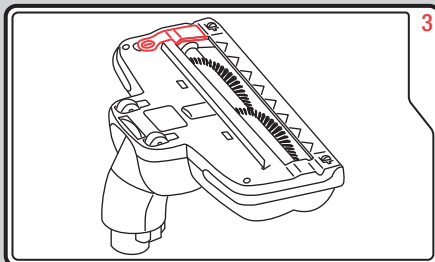

If the motorised floor brush (19) is stalled, eg. by a foreign object or if used on very deep pile carpet, the floor brush power indicator light (18) will extinguish. Switch off, remove the cause of the stall, and leave for a few minutes to allow the floor nozzle protection to self reset.

To clean the motorised floor brush, you must remove the handheld vacuum cleaner as shown in 'Handheld vacuum cleaning', page 7. Then, press the floor brush release button (17) and pull the motorised floor brush away.



Turn the motorised floor brush over to inspect the brush bar.

Using a coin, turn the locking button on the brush bar cover anti-clockwise from the  position to the  position.

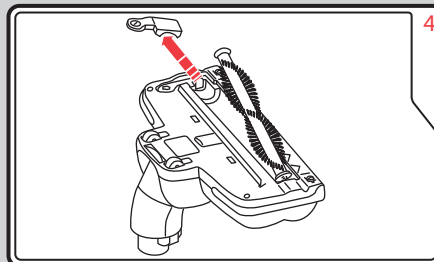

Remove the brush bar cover and lift the brush bar out. Pull away any hairs or fibres from the brush bar. If they are tightly wound around the brush, carefully snip the fibres with scissors, being careful not to damage the rotating brush bar, pull away from the rotating brush bar and dispose of. Replace the brush bar and cover in their original position.

Handheld vacuum cleaning

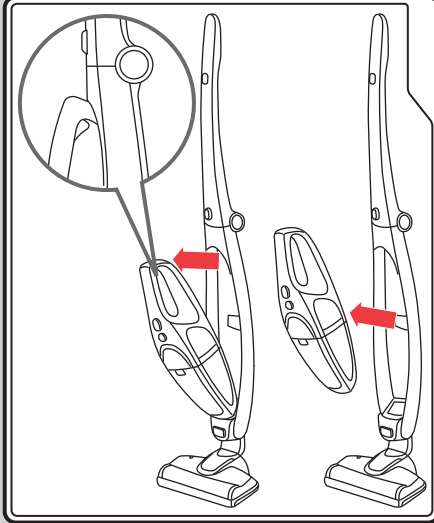

This function is ideal for cleaning stairs, curtains, upholstery and hard to reach places.

- 1** To separate the handheld vacuum cleaner (12) from the main vacuum cleaner body (7), press the handheld vacuum cleaner release button (8).
- 2** Pull the handheld vacuum cleaner away from the main vacuum cleaner body (7).
 - After use, return the handheld vacuum cleaner (12) to the cavity on the main vacuum cleaner body (7) by firstly sliding the suction end into place over the suction hole in the main vacuum cleaner body cavity, then push the handle end in to place until a click is heard.

Using the attachments on the handheld vacuum cleaner

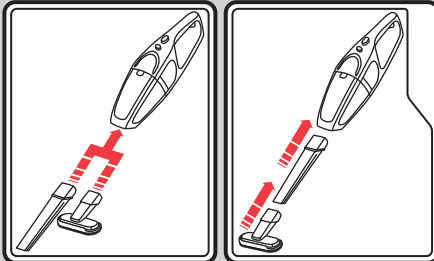

Push the accessories (1) or (2) into the suction inlet on the end of the handheld vacuum cleaner.

Alternatively, for extra reach, attach the accessories together and push the assembly into the suction inlet on the end of the handheld vacuum cleaner.

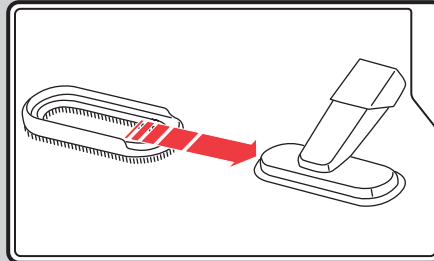

List of attachments

Crevice tool (1) for awkward places, corners and behind radiators etc. This tool is also useful on stairs.

Upholstery nozzle (2) for carpet, upholstery and stairs etc.

Dusting brush (3) for carpet, upholstery and stairs etc. The dusting brush (3) attaches to the upholstery nozzle (2) by sliding on from the side as shown above.

Tool storage

When not in use, the attachments may be stored on the charging cradle base (20). Assemble the dusting brush (3) onto the upholstery nozzle (2) and push them onto the crevice tool (1). Then push this assembly onto the accessory holder (16) on the charging cradle (15).

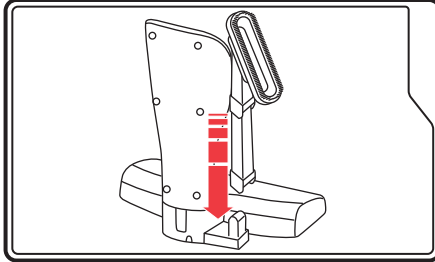

Emptying the dust canister

Empty the dust canister (13) regularly even if it does not look full, this will maintain the performance.

1. Remove the handheld vacuum cleaner (12) from the main vacuum cleaner body (7) (see 'Handheld vacuum cleaning', page 7).
2. Press the dust canister release button (11) and pull the dust canister away from the handheld vacuum cleaner.

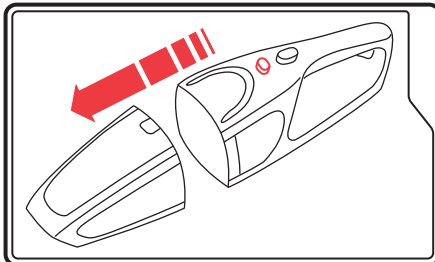

3. Remove the dust canister filter (14) and empty the dirt from inside the dust canister.

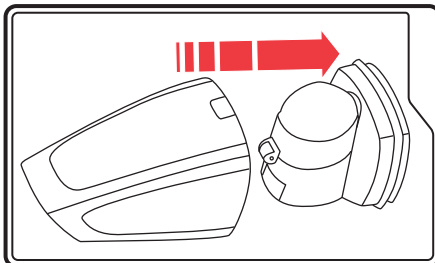

4. If the filter (14) is not washed as instructed in 'Maintenance - filter', it is recommended that the filter is brushed or tapped clean before refitting on each empty of the dust canister.
5. Replace the filter into the dust canister (13), then replace the dust canister back onto the handheld vacuum cleaner.
6. Replace the handheld vacuum cleaner (12) back into the main vacuum cleaner body (7) if upright cleaning.

Maintenance

WARNING: Always remove the handheld vacuum cleaner from the main vacuum cleaner body and the charger from the mains supply before undertaking any maintenance or cleaning procedures.

Your cleaner is manufactured to withstand normal day-to-day use, but an occasional wipe over with a damp cloth will help maintain its good looks. Take care not to get the electrical connections wet. Abrasive cleaners should not be used.

Maintenance - filter

The guarantee may be invalidated if the motor is damaged due to: using the appliance without the filter installed; not cleaning the filter; or not replacing a damaged filter.

Cleaning the dust canister filter

To maintain suction, the dust canister filter must be cleaned each time the dust canister (13) is emptied.

1. Follow steps 1-4 of 'Emptying the dust canister'.
2. Pull the filter out from the filter assembly (14). Also, open the lid to the cyclone cone and clean the cyclone.

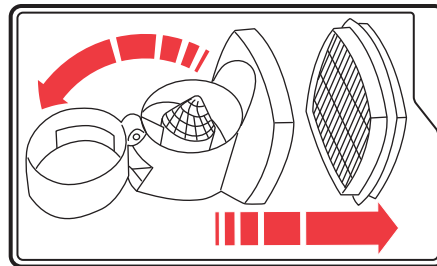

3. Every month, wash the filter in luke-warm water and thoroughly air dry before re-fitting.

IMPORTANT: Do not wash filters with hot water or detergents.

IMPORTANT: Do not use heated appliances to dry filters.

4. Replace the filter into the dust canister (13) then replace the dust canister back onto the handheld vacuum cleaner (12).
5. Replace the handheld vacuum cleaner back into the main vacuum cleaner body (7) if upright cleaning.

Maintenance - troubleshooting

- **“Does not pick-up”/ “Motorized floor-brush running slow or soon stops”**

Check for hairs/fibres that may be wrapped around the rotating brush-bar.

IMPORTANT: Remove the brush bar as described on page 6. Fine hairs or fibres may be caught unseen in the ends of the brush bar. Carefully remove the hairs and re-fit the brush bar.

- **“Does not pick-up” / “Suction of handheld cleaner has reduced”**

In addition to emptying the dust canister, it is very important that the filters inside the handheld cleaner are regularly and thoroughly cleaned. See page 8 for details of how to access and clean the filter.

- **“Does not pick-up from the floor but the floor brush is rotating and the handheld has good suction”**

Switch off the product, remove the motorised floor brush and check for blockages in the connector between the motorised floor brush and the main vacuum cleaner body.

- **“Product not charging”**

Check the indicator light (11) on the front of the handheld cleaner is glowing red to indicate that charging is in process. If the indicator is not showing red, check: a) the product is correctly seated on the charging cradle; b) the mains plug is fully fitted into the mains socket and the socket is switched on. If these are OK, check the fuse in the mains plug.

Storage

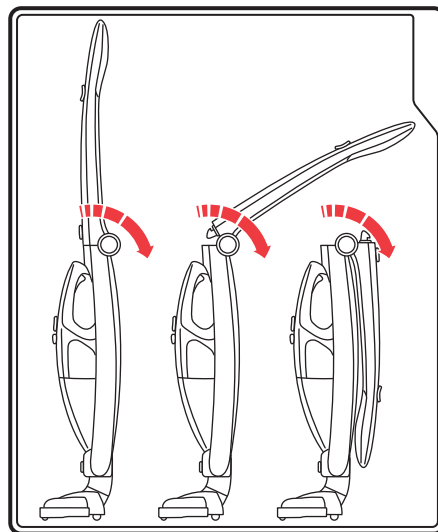

1. Fit the handheld vacuum cleaner (12) back into the cavity on the main vacuum cleaner body (7) by firstly sliding the suction end into place over the suction hole in the main vacuum cleaner body cavity, then push the handle end in to place until a click is heard.
2. Insert the assembled upright unit into the charging cradle (15).
3. The upright handle (4) is collapsible for compact storage by pressing the upright handle release button (6).



4. Place the tools onto the accessory holder (16) (see 'Tool storage', page 8).

WARNING: When locking the handle, keep this area clear. Be careful not to trap your fingers or any loose items of clothing etc.

Disposal

 When the product reaches the end of its useful life, it must not be disposed of in normal household waste. The **NiMH** product must be disposed of at an authorised recycling plant. 

The handheld vacuum cleaner (12) should only be disassembled by a competent engineer and the battery removed and disposed of at an authorised recycling plant. Your local authority will have a centre which accepts such waste for recycling.

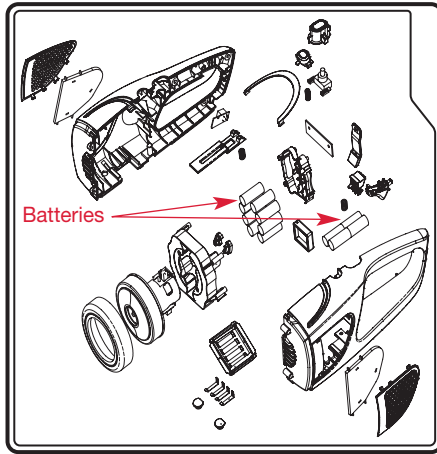

WARNING: Batteries and products containing batteries must never be disposed of in fires.

Contact us

Helpline

If you are having a problem with your appliance, please call our Helpline, as we are more likely to be able to help than the store you purchased the item from.

Please have the product name, model number and serial number to hand when you call to help us deal with your enquiry quicker.

UK Helpline: 0844 871 0960
IRE Helpline: 1800 409 119
Spares: 0844 873 0726

Talk To Us

If you have any questions or comments, or want some great tips to help you get the most out of your products, join us online:

Blog: www.morphyrichards.co.uk/blog
Facebook: www.facebook.com/morphyrichardsuk
Twitter: @loveyourmorphy
Website: www.morphyrichards.com

Notes

Please attach your receipt to this page. This will be needed if you have any issues with the appliance.

Notes

<hr/>	<hr/>
<hr/>	<hr/>
<hr/>	<hr/>
<hr/>	<hr/>
<hr/>	<hr/>
<hr/>	<hr/>
<hr/>	<hr/>
<hr/>	<hr/>
<hr/>	<hr/>
<hr/>	<hr/>
<hr/>	<hr/>
<hr/>	<hr/>
<hr/>	<hr/>
<hr/>	<hr/>
<hr/>	<hr/>
<hr/>	<hr/>
<hr/>	<hr/>
<hr/>	<hr/>
<hr/>	<hr/>
<hr/>	<hr/>
<hr/>	<hr/>
<hr/>	<hr/>
<hr/>	<hr/>
<hr/>	<hr/>
<hr/>	<hr/>
<hr/>	<hr/>
<hr/>	<hr/>

VC732000 MUK Rev1 12/13

Registering your 2 year guarantee

Your standard 1 year guarantee is extended for an additional 12 months when you register the product within 28 days of purchase with Morphy Richards. If you do not register the product with Morphy Richards within 28 days, your product is guaranteed for 1 year. To validate your 2 year guarantee, register with us online at

www.morphyrichards.co.uk

Or call our customer registration line

UK 0844 871 0962

IRE 1800 409 119

N.B. Each qualifying product needs to be registered with Morphy Richards individually.

Please note that the 2 year guarantee is only available in the UK and Ireland. Please refer to the 1 year guarantee for more information.

Your 1 year guarantee

To qualify for the 1 year guarantee, the appliance must have been used according to the instructions supplied.

It is important to retain the retailer's receipt as proof of purchase. Staple your receipt to this back cover for future reference.

Please quote the following information if the product develops a fault. These numbers can be found on the base of the product.

Model no. Serial no.

All Morphy Richards products are individually tested before leaving the factory. In the unlikely event of any appliance proving to be faulty within 28 days of purchase, it should be returned to the place of purchase for it to be replaced. If the fault develops after 28 days and within 1 year (2 years if registered) of original purchase, you should contact the Helpline number quoting Model number and Serial number on the product, or write to Morphy Richards at the address shown.

You may be asked to return a copy of proof of purchase. Subject to the exclusions set out below (see Exclusions), the faulty appliance will then be repaired or replaced and dispatched usually within 7 working days of receipt.

If you suspect a fault, follow the simple checks detailed below before retrying the appliance or calling the helpline.

- Check the filters for blockages and clean.
- Check the tools / tubes for blockages.
- Check the appliance is charged.
- Check the socket used for charging is working and the charging adaptor is firmly in the socket during charging.

If, for any reason, this item is replaced during the 1 year guarantee period, the guarantee on the new item will be calculated from original purchase date. Therefore it is vital to retain your original till receipt or invoice to indicate the date of initial purchase. To qualify for the 1 year guarantee, the appliance must have been used according to the instructions supplied.

This appliance is intended for domestic use only. Misuse or use for commercial or any other purpose will render the guarantee invalid.

Exclusions

Morphy Richards shall not be liable to replace or repair the goods under the terms of the guarantee where:

- 1 The fault has been caused or is attributable to accidental use, misuse, negligent use or used contrary to the manufacturer's recommendations or where the fault has been caused by power surges or damage caused in transit.
 - 2 The appliance has been used on a voltage supply other than that stamped on the products.
 - 3 Repairs have been attempted by persons other than our service staff (or authorised dealer).
 - 4 The appliance has been used for hire purposes or non domestic use.
 - 5 The appliance is second hand.
 - 6 Morphy Richards reserves the right not to carry out any type of servicing under the guarantee at its discretion.
 - 7 The guarantee excludes consumables such as the filter.
- This guarantee does not confer any rights other than those expressly set out above and does not cover any claims for consequential loss or damage. This guarantee is offered as an additional benefit and does not affect your statutory rights as a consumer. Morphy Richards products are intended for household use only. See usage limitations within the location safety instructions.

Disclaimer

Morphy Richards has a policy of continuous improvement in product quality and design. The company, therefore reserves the right to change the specification of its models at any time.



For electrical products sold within the European Community. At the end of the electrical products useful life, it should not be disposed of with household waste. Please recycle where facilities exist. Check with your Local Authority or retailer for recycling advice in your country.



NiMH

Battery should be removed at the end of the product's life for recycling.

**IF YOU ARE HAVING A PROBLEM
WITH ONE OF OUR PRODUCTS,
CALL OUR HELPLINE:**

**UK: 0844 871 0960
EIRE: 1800 409 119
SPARES: 0844 873 0726**

morphy richards

The After Sales Division
Morphy Richards Ltd
Mexborough,
South Yorkshire,
England, S64 8AJ

www.morphyrichards.com

