

.....
PURCHASED FROM

.....
DATE OF PURCHASE

.....
MODEL NO

.....
OWNERS NAME

.....
ADDRESS

.....



Perforation

Accurist Helpline

020 7447 3945

Further information or instructions can be obtained
from the Accurist Helpline during office hours Monday to Friday.

Folding

Accurist

BritishRealTime.com

Automatic / Quartz Analogue

Watch Setting Instructions

Including 8N24, YM22A, GP00 / GP01,

6P23 / 6P20 / 6P21 / JR00

Contents

How to use these instructions	3
Quartz Analogue Operating Instructions	5
8N24 - Automatic Skeleton Movement Operating Instructions	11
GP00 / GP01 Retrograde Operating Instructions	13
YM22A Operating Instructions	15
6P23 Operating Instructions	17
6P29 / 6P20 / 6P21 Operating Instructions	19
JR00 Operating Instructions	24
Care of your watch	28
WEEE Directive	32
Bracelet Adjustment	34
International Service Agents	36
Resistance to water	39
Accurist Quartz Guarantee	42
After Sales Service	44
Payment & Postage Instructions	45

Caseback markings

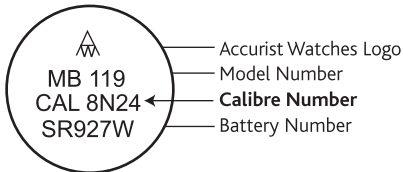

How to use these instructions

This booklet contains setting instructions for the Accurist Quartz Analogue series of watches. Each section describes a particular calibre (also called watch movement) which offers a unique set of functions and features. As such, it is necessary to identify the correct calibre of your watch before proceeding to the appropriate section (see diagram opposite).

Further information

The latest setting instructions, technical manuals and interactive instructions are available from our web site at www accurist.co.uk and www.britishrealtime.com

When on the web site please refer to 'After sales service/download manuals'

The Accurist technical helpline is also available during office hours:
+44 (0)20 7447 3941 or email service@accurist.co.uk

Quartz Analogue Operating Instructions

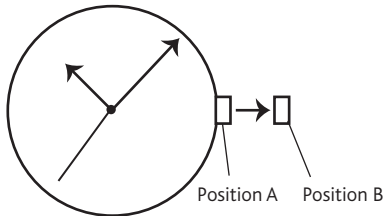

Please note: The second hand will not start moving until the crown has been returned to Position A.

To set the time:

1. Gently pull out crown to Position B.
2. Turn crown either way to correct time.
3. Push in crown to Position A.

Quartz Analogue Operating Instructions continued...

For Calendar Models

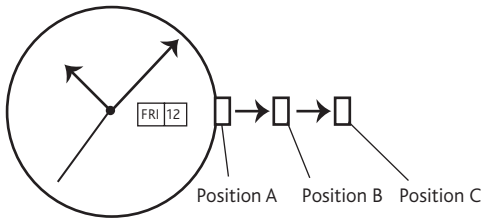

To set the calendar/date:

1. Gently pull out crown to Position B.
2. Turn crown anti-clockwise to adjust date, clockwise to adjust the day.
3. Push in crown to Position A.

Note: The Day will start to change at 11.25 p.m. and complete its change by 12 0' clock midnight. The Date will start to change at 12 0' clock midnight and complete its change by 4 a.m. Day/Date models have Bi-Lingual day settings; if you select English, the watch will continue to display in English.

Quartz Analogue Operating Instructions continued...

For Alarm Models

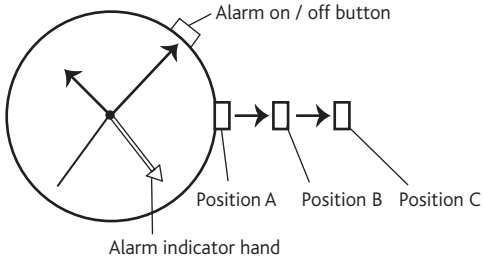

To set the alarm:

1. Gently pull out crown to Position B.
2. Turn crown clockwise to adjust the alarm indicator hand.
3. Push in crown to Position A.

To switch alarm on, gently pull out Alarm On/Off Button.

To switch alarm off, depress the Alarm On/Off Button.

Note: The alarm will sound for 15 seconds, before automatically switching itself off. After 2 minutes, the alarm will automatically repeat for a further 15 seconds before switching itself off.

8N24 - Automatic Skeleton Movement Operating Instructions

Automatic Watches, otherwise known as self-winding watches, should be worn for at least 6-8 hours a day this is because they rely on the oscillating weight inside of the watch to wind the mainspring from the movement of your wrist.

To initially start your watch in motion turn the winder 6 – 8 times in a clockwise direction and then set the time. When the watch is worn, the oscillating weight sways back and forth causing

the watch to wind itself. Wearing the watch on your wrist for a further 6 hours will fully wind the mainspring and will create a reserve power between 30 – 40 hours.

If the watch is not worn for a period of time or only worn occasionally, the watch will run down. If this is the case, the watch can be wound manually by turning the winder approximately 20 times in a clockwise direction.

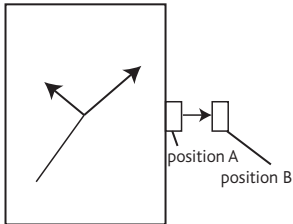
**To wind the mainspring:**

1. Ensure crown is in Position A (Normal time mode)
2. Turn crown clockwise approximately 15 – 20 times.

To set the time:

1. Gently pull out crown to Position B.
2. Turn crown either way to correct time.
3. Push in crown to Position A.

GP00 / GP01 Retrograde Operating Instructions

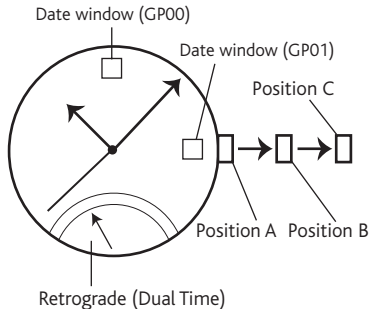

To set the time:

1. Gently pull out crown to Position C.
2. Turn crown either way to correct time.
3. Push in crown to Position A.

Date window at 12-hour position
on Calibre GP00.

Date window at 3-hour position
on Calibre GP01.

To set the calendar/date:

1. Gently pull out crown to Position B.
2. Turn crown clockwise to adjust date.
3. Push in crown to Position A.

24 Hour / Dual Time hand at 6-hour position.

To set 24 HR Hand / Dual Time (Retrograde):

1. Gently pull out crown to Position B.
2. Turn crown anti-clockwise to adjust dual time.
3. Push in crown to Position A.

Note: When setting the time, please be sure to adjust the retrograde 24-hour hand to am or pm.

YM22A Operating Instructions

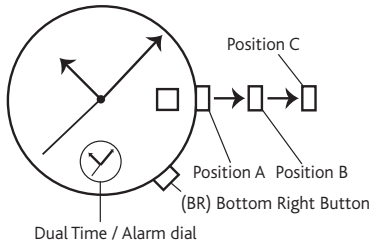

To set the time:

1. Gently pull out crown to Position C.
2. Turn crown either way to correct time.
3. Push in crown to Position A.

To set the date:

1. Gently pull out crown to Position B.
2. Turn crown clockwise to adjust date.
3. Push in crown to Position A.

To set the Dual Time:

1. Gently pull out crown to Position C.
2. Push the Bottom Right (BR) Button to set dual time.
Press and hold BR Button to quick change the dual time hands.
3. Push in crown to Position A.

Please ensure you set up the dual time before you set up the alarm.

To set the Alarm:

1. Gently pull out crown to Position B.
2. Push the Bottom Right (BR) Button to set alarm to the dual time.
3. Press and hold BR Button to quick change the Alarm hands.
4. Push in crown to Position A.

Please Note. The alarm will sound to the dual time.

6P23 Operating Instructions

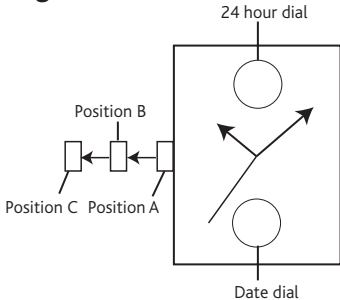

To set the time:

1. Gently pull out crown to Position C.
2. Turn crown either way to correct time.
3. Push in crown to Position A.

To set the date:

1. Gently pull out crown to Position B.
2. Turn crown anti-clockwise to adjust date.
3. Push in crown to Position A.

Note: When setting the time, please be sure to adjust the 24-hour dial to am or pm.

6P29 / 6P20 / 6P21 Operating Instructions

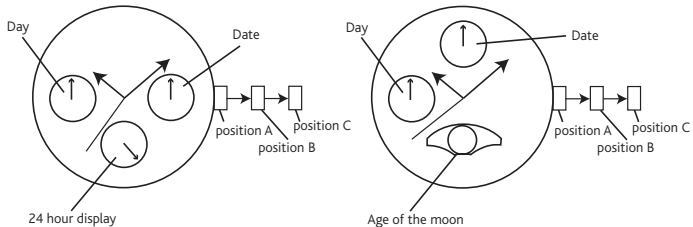

To set the time/day

1. Gently pull out crown to Position C.
2. Turn crown either way to set the time.
3. Push in crown to Position A.

To set the day of the week

1. Gently pull out crown to Position C.
2. Turn crown clockwise to advance the hour hand by 24 hours per day.
3. Push in crown to Position A.

To set the date

1. Gently pull out crown to Position B.
2. Turn crown anti-clockwise to adjust date.
3. Push in crown to Position A.

To set the moon age:





Note: More accurate settings can be made during a new moon (when the centre of the moon aligns to '0' on the scale) or during a full moon (when the centre of the moon aligns to '15' on the scale)

1. Gently pull out crown to Position B.
2. Turn crown clockwise to adjust the moon age.
3. Push in crown to Position A.



To read the moon age:

Note: The age of the moon is determined by the period between each new moon. This period is approximately 29.5 days. The moon dial can be used as a guide to moon phase and tides.

New Moon Moon's age: 0 Spring tide	First quarter moon Moon's age: 7 Neap tide	Full moon Moons age: 15 Spring tide	Last quarter moon Moon's age: 22 Neap tide
			

For Electro-Luminescent Models

Electro-Luminescent is state-of-the-art technology which allows you to read your watch under any lighting conditions.

To operate depress the Electro-Luminescent Button.

Note: The battery life will be affected by the number of times the E L display is operated; based on typical use of 2-3 times a day; the battery life expectancy is 2 years.

JR00 Operating Instructions

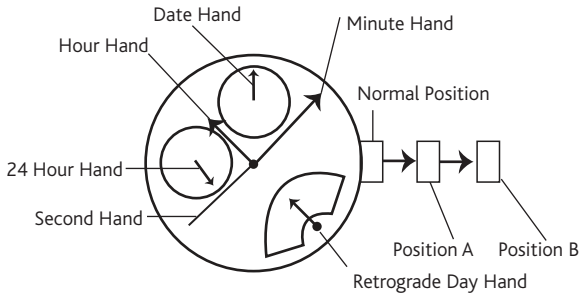

To set the time:

1. Pull the crown out to position B.
2. Turn the crown to set hour and minute hands.

To set the date:

*** Please do not set the date between 9.00pm and 1.00am**

1. Pull the crown out to position A.
2. Turn the crown counter clockwise to set the date.
3. After the date has been set, push the crown back to the normal position.

Please do not stop when the day hand is in this position

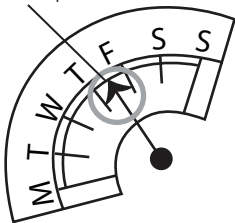

Please set the day hand just positioned on the day scale

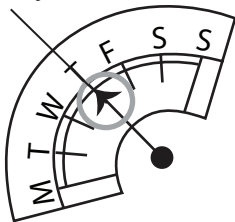

To set the day:

*** Please do not set the day between 11.00pm and 3.00am.**

1. Pull the crown out to position A.
2. Turn the crown clockwise very slowly to set the day.

*** Please do not stop when the hand is between the day as shown in fig 1.**

*** If the day hand stops at a position like in fig 1. please turn the crown clockwise very slowly and stop soon after the day hand positioned as shown in fig 2.**

3. After the day has been set, push the crown back to the normal position.

Care of your watch

Avoid temperature extremes

1. Avoid leaving your watch in direct sunlight or in extremely warm conditions for long periods of time: this will cause malfunctioning and shorten the life of the battery.
2. Do not leave your watch for long periods of time in extremely cold places; this may cause your watch to gain or lose time. Should it begin to gain or lose time, place your watch on your wrist to restore its original accuracy.

Avoid wet conditions

1. Do not operate the buttons when your watch is wet, even on models marked 'Water Resistant'
2. Check case back markings and refer to the Resistance to water section.

continued...

Avoid strong shocks

1. This watch will withstand the bumps and jars normally incurred during sports activities.
2. Avoid dropping your watch on the ground or otherwise imparting severe shock to it.

Avoid strong magnetic fields

1. Keep your watch away from strong magnets
2. Generally, your watch is not affected by magnetic fields from household appliances such as television sets and stereo equipment.

continued...

Care of your watch continued . . .

Avoid harmful chemicals, solvents & gases

1. Avoid wearing your watch in the presence of strong chemicals, solvents or gases.
2. Avoid materials such as gasoline, benzene, paint thinner, alcohol, spray cosmetics, nail polish, nail polish remover, adhesives or paint.

Periodic inspection

1. A regular 4 to 5 years service by an authorised Accurist technician will ensure trouble free operation.
2. Refer to the After Sales Service section for details.

continued...

IMPORTANT

1. Keep the batteries out of reach of infants and small children. Should accidental ingestion occur consult a doctor immediately.
2. Do not attempt to replace the battery yourself as this invalidates your guarantee.

Keep you watch clean

Wipe off any moisture that adheres to the case, glass or band with a soft, clean cloth.



WEEE Directive

The crossed-out wheeled bin indicates that used electrical and electronic equipment should not be mixed with general domestic waste. There is a separate collection point for these products.

The objectives of the Community's environment policy are, in particular, to preserve, protect and improve the quality of the environment, protect human health and utilise natural resources prudently and rationally.

Disposal information for consumers

EU Countries

In accordance with legislation that requires proper treatment, recovery and recycling of used electrical and electronic equipment. Private households within the EU states may return their used electrical and electronic equipment to designated collection points free of charge. Equally return your product to an Accurist stockist or Accurist headquarters, who will see to the products disposal. Please contact your authority for further details.

WEEE Directive continued . . .

Non EU Countries

If you wish to discard this product, please contact your local authorities and ask for the correct method of disposal. Otherwise please return to Accurist headquarters, who will see to the products disposal.

Disposal information for business users

EU Countries

Please contact your Accurist dealer who will inform you about the 'take back' of products.

Non EU Countries

If you wish to discard this product, please contact your local authorities and ask for the correct method of disposal. Otherwise please return to Accurist headquarters, who will see to the products disposal.

Bracelet Adjustment

The bracelet requires a small adjustment and the model has a Z-type clasp.



1. Depress the end of the spring bar on the centre clasp with a pin.



2. Relocate the spring bar in an alternative hole.

The bracelet requires a significant adjustment or the model does not have a Z-type clasp.

1. Use the enclosed wrist gauge to measure and mark the size of your wrist.
2. Return the completed wrist gauge with your watch
3. Follow the instructions in the After Sales Service section to return your watch for adjustment. Your watch will be adjusted free of charge.

International Service Agents

International Service Headquarters

Accurist Watches Limited, Asher House, Blackburn Road, West Hampstead,
London, NW6 1AW

Tel: +44 (0)20 7447 3945, Fax: +44 (0)20 7447 3946

United Arab Emirates

Al Abbas, P.O. Box 45999, Dubai, UAE

Tel: 00971 4 351 2440, Fax: 009714 351 2450

Netherlands

Sabre Nederland B.V., Ellermanstraat 23, 1099 BX Amsterdam, The Netherlands
Tel: 0031 20 692 8888, Fax: 0031 20 665 2184

Switzerland

Nimex AG, Raffelstr 11, CH - 8045, Zurich, Switzerland
Tel: 0041 44 462 91 91, Fax: 0041 44 462 91 81

Norway

Thune, Nils Hansensvei 2, N - 0667 Oslo, Norway
Tel: 0047 22 70 08 40, Fax: 0047 22 70 08 41

Malta

Maxi Quartz Ltd, 311-313 Zabbar Road, Fgura, Malta
Tel: 693843, Fax: 676393

Kingdom of Saudi Arabia

Al Asayah, Sitteen Street, P.O. Box 19248 - 19249, Jeddah 21435
Tel: 00966 672 6826, Fax: 00966 676 2262

N. Antilles

J Best Jeweler, 2 Front Street, Philipsburg, St. Maarten, N. Antilles
Tel: + 599 542 2294, Fax: + 599 542 1351, US Toll Free 1 877 J IS BEST

Cyprus

A Chrysanthou Ltd, 35 Kappadokias Street, Strovolos 2028
Tel: 00357 22 512 122, Fax: 00357 22 512 880

Resistance to water

INDICATIONS ON DIAL OR CASEBACK		LIGHT SPRAY, PERSPIRATION, LIGHT RAIN BATHING, ETC...	SWIMMING ETC...
DIAL	CASEBACK		
-	WATER RESISTANT	OK	X
WATER RESISTANT 50M (5 ATM)	WATER RESISTANT	OK	OK
WATER RESISTANT 100M (10 ATM)	WATER RESISTANT	OK	OK
WATER RESISTANT 150M (15 ATM) AND DEEPER	WATER RESISTANT	OK	OK

SKIN DIVING: DIVING WITHOUT AN AIR TANK	SCUBA DIVING: DIVING WITH AN AIR TANK	DIVING: WHEN USING A HELIUM ENRICHED ENVIRONMENT
X	X	X
X	X	X
OK	X	X
OK	OK	X

Resistance to water

IMPORTANT - NEVER PULL OUT THE CROWN WHEN THE WATCH IS WET.

- Tighten screwlock crown completely
- Water resistance is not a permanent property. We strongly recommend you return your watch for resealing every 4 - 5 years and/or when changing batteries
- "Water resistant" may sometimes be abbreviated as "Water resist" or "WR".
- Never pull out the crown when the watch is wet.
- Always set the crown in the normal position.

Accurist Guarantee

The terms of this guarantee provide rights that are in addition to your statutory rights and do not in any way limit or otherwise affect those statutory rights.

Your Accurist watch is guaranteed for 3 years from the date of original retail purchase against any malfunction of the watch movement due to defective materials or workmanship. This guarantee is applicable only to watches purchased in the United Kingdom. The guarantee is only valid if completed and dated at the time of purchase by your Accurist stockist.

To make a claim under the guarantee please return your watch directly to the International Service Headquarters at the address set out on page 36 or an International Service Agent.

Accurist Quartz Guarantee continued . . .

When returning your watch, please indicate brief details of the nature of the problem and the repair required.

We will, at our option, repair or replace your watch with a model of similar appearance or value.

After the expiry of this guarantee the Accurist Service Centre and International Service Agents are at your complete disposal.

We will be pleased to quote for routine maintenance, oiling or repair of your watch by our factory trained staff of experts.

This guarantee is provided by Accurist Watches Limited of Asher House, Blackburn Road, West Hampstead, London, NW6 1AW, England, United Kingdom

After Sales Service

Each Accurist watch comes with a lifetime commitment to quality after sales service. Our award winning customer service team are dedicated to providing expert servicing from bracelet adjustments to full overhaul. We pride ourselves in identifying our customer's requirements and reacting to their individual needs. An expert watchmaker personally services each watch and Accurist guarantees quality at every step of the process.

Payment & Postage Instructions

1. Complete the payment details form opposite.
2. Return the watch and payment details form together with this guarantee to the Accurist Service Centre address listed on page 36.
3. Enclose a cheque, postal order or MasterCard/Visa payment for **£5.00** payable to Accurist Service Centre. This covers return postage and insurance for loss or damage whilst in transit or undergoing repairs. No liability for loss or damage will be accepted without this remittance.
4. Please do not return your presentation box as we cannot guarantee its return.

Accurist Watches Limited
 Asher House
 Blackburn Road
 West Hampstead
 London, NW6 1AW

Telephone: +44 (0)20 7447 3900
 Fax: +44 (0)20 7447 3949

Email: info@accurist.co.uk

For latest information please check our websites:
www.accurist.co.uk & www.britishrealtime.com

Published January 2009

Folding

For all other countries

1. Return the watch with payment to your nearest International service agent (see page 36).
2. Enclose a cheque for **€7.50**. This covers return postage and insurance for loss or damage whilst in transit or undergoing repairs. No liability for loss or damage will be accepted without this remittance.

Perforation

I enclose: cheque postal order credit card,
 debit card (issue no.) payment for **£5.00**

Card No:

--	--	--	--	--	--	--	--	--	--	--	--	--	--	--	--

Expires: / / * CSC number:

--	--	--

Name: _____

Address: _____

Postcode: _____

Signature: _____

* This is the last three digits on the signature strip of your card