

Assembly Instructions

Step 7

Assembling the storage drawer

Two people are needed here.

c: Slide Bottom board **12** into the grooves.

d: Attach Front board **8** by the two Side board **11** with the Bolts **A**.

e: Fix the Support bars **10** to the Front board **8** and Back board **9** with Bolts **A**.

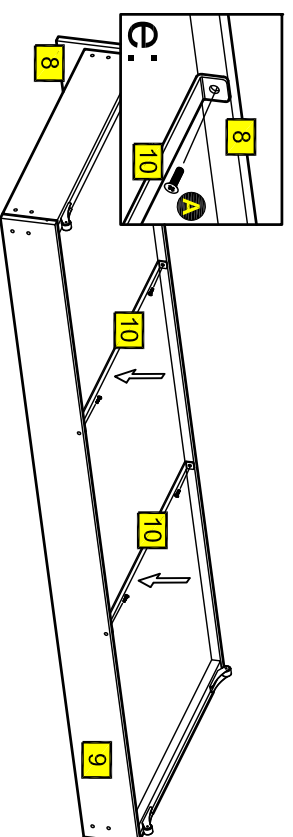
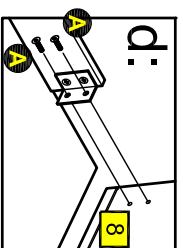
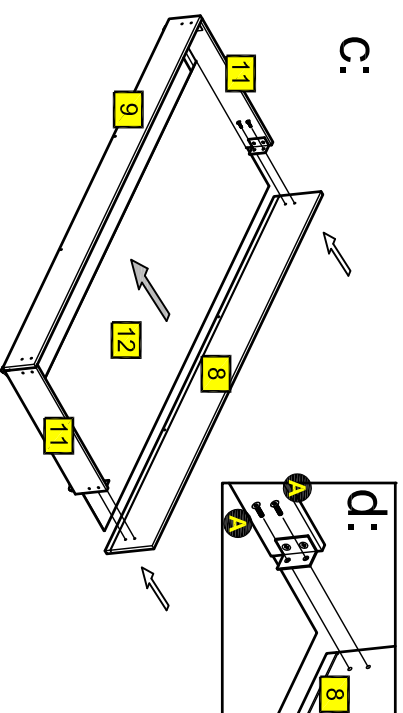

Now fully tighten all bolts

Step 8

Attaching slats

For this stage requires two people.

a: Insert the storage drawer in its place.

b: Roll the slats over the sides **3** and **4**, and connect slats over the wood elements that are attached on both sides of the Side Rails **3** and **4**.

Slats to be rolled out with staples on the underside.

Repeat operation for all 4 corners.

Assembly is now complete.

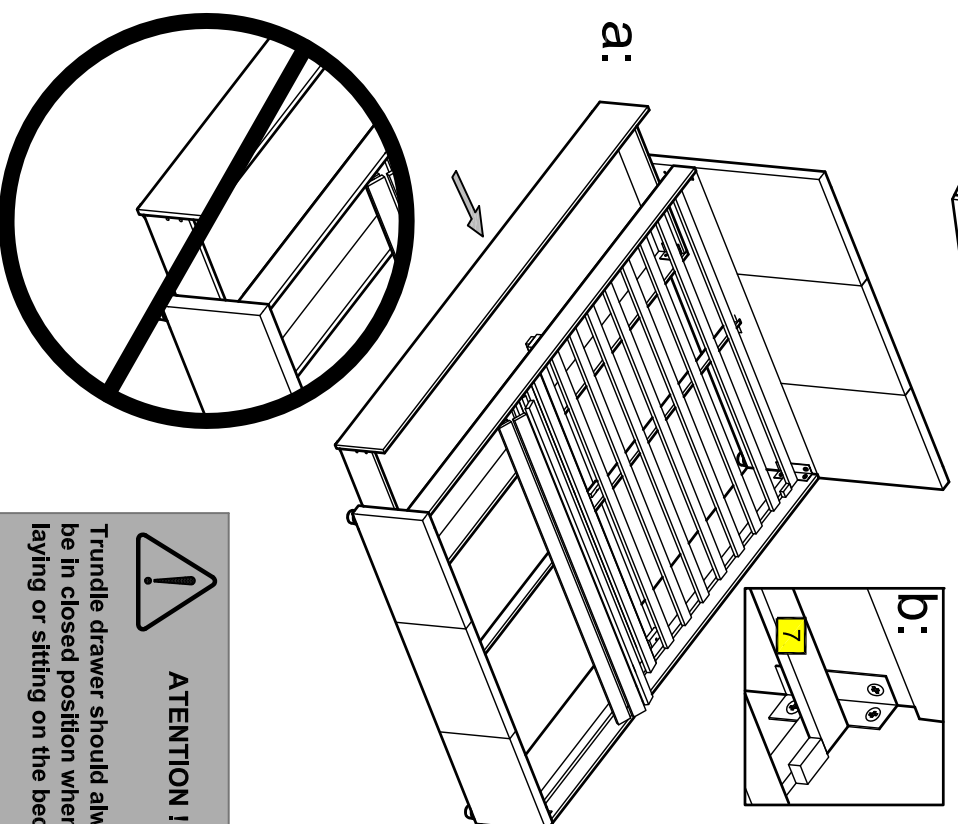

ATTENTION !

Trundle drawer should always be in closed position when laying or sitting on the bed .

Hariette 5FT

Assembly Instructions - Please keep for future reference

Cat.no 248 / 9193

Cat.no 244 / 5151

Cat.no 248 / 7542

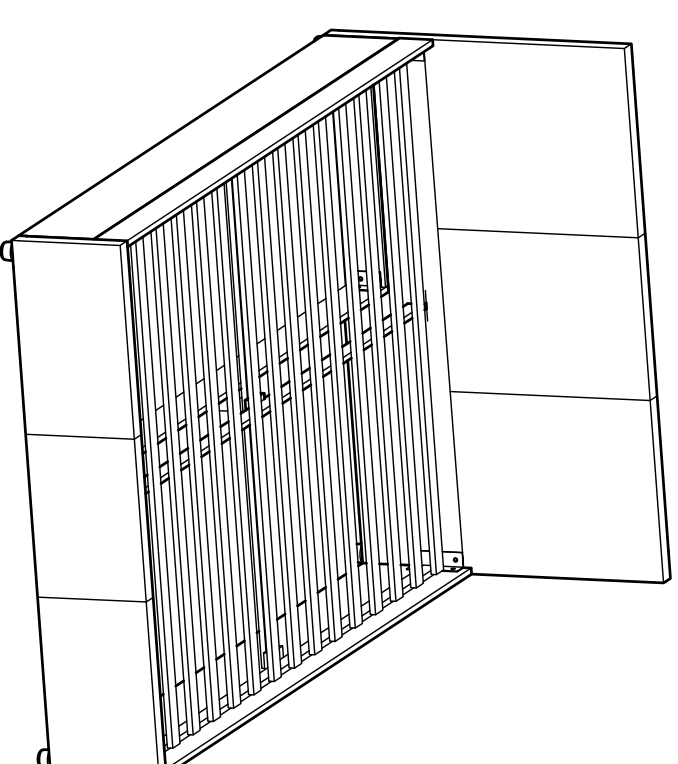

Dimension

Width - 155cm

Length - 213cm

Height - 87cm

Important - Please read these instructions fully before starting assembly

If you need help or have damaged or missing parts, call the Customer Helpline: Argos = 0835 6400800



Safety and Care Advice

Important - Please read these instructions fully before starting assembly

- Check you have all the components and tools listed on pages 2 and 3.
- Remove all fittings from the plastic bags and separate them into their groups.
- Keep children and animals away from the work area, small parts could choke if swallowed.
- Make sure you have enough space to layout the parts before starting.
- Do not stand or put weight on the product, this could cause damage.
- Assemble the item as close to its final position (in the same room) as possible.
- Assemble on a soft level surface to avoid damaging the unit or your floor.
- Parts of the assembly will be easier with 2 people.
- We do not recommend the use of power drill/drivers for **inserting screws** as this could damage the unit. Only use hand screwdrivers.
- Dispose of all packaging carefully and responsibly.
- Do not tighten all bolts until bed is fully assembled.

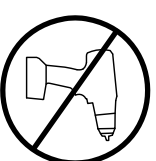

We do not recommend the use of power drill/drivers for

inserting screws

as this could damage the unit. Only use hand screwdrivers.

Dispose of all packaging carefully and responsibly.

Do not tighten all bolts until bed is fully assembled.

Care and maintenance

- Only clean using a damp cloth and mild detergent, do no use bleach or abrasive cleaners.
- From time to time check that there are no loose bolts on this unit.
- This product should not be discarded with household waste. Take to your local authority waste disposal centre.

Handy Hints

- Assemble all parts and bolts loosely during assembly, only once the product is complete should you fully tighten the bolts
- Regularly check and ensure that all bolts and fittings are tighten properly.

Assembly Instructions

Step 5

Attaching support bar

a: Enter the ensemble format from Central support bar **[6]**, **[5]** and Support leg **[F]**. Rotate and match the Central support bar **[6]** under central wood element from the Side Rail **[3]** and **[4]**.

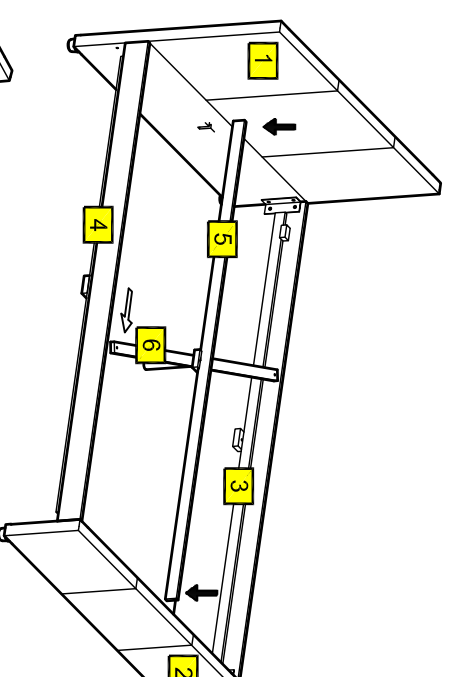
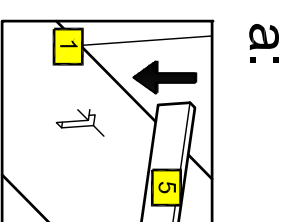

b: Insert Bolt **[G]** through central hole on the Side rail **[3]** and through end holes and secure tightly to right.

Make the same for the other Side rail **[4]**.

Now secure tightly to right the Support leg **[F]**.

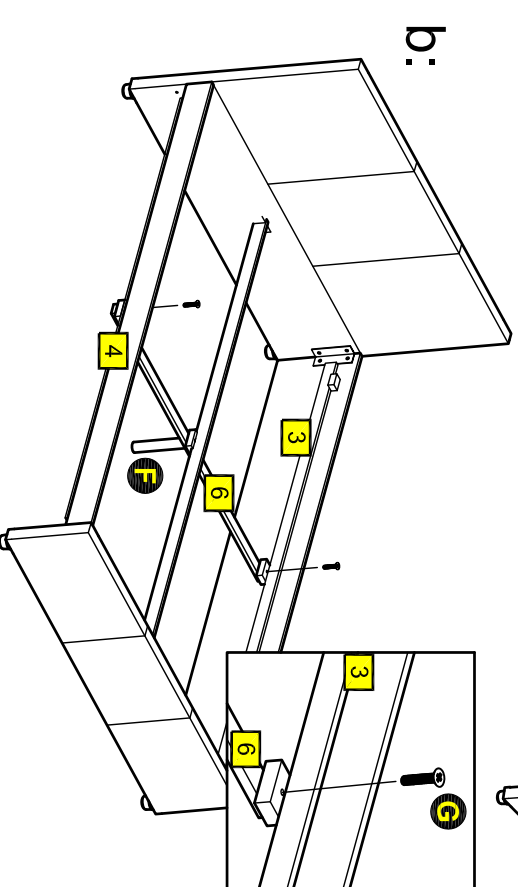

Step 6

Assembling the storage drawer

a: Fix the both Angle corners **[E]** to the Side board **[11]** of the storage drawer with Bolts **[A]**.

Make the same operation with the other side board of the storage drawer **[11]**.

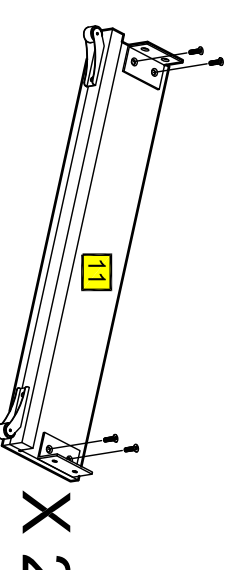
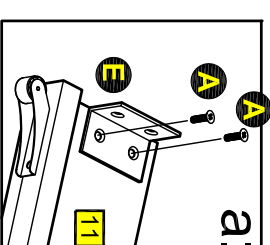

X 2

b:

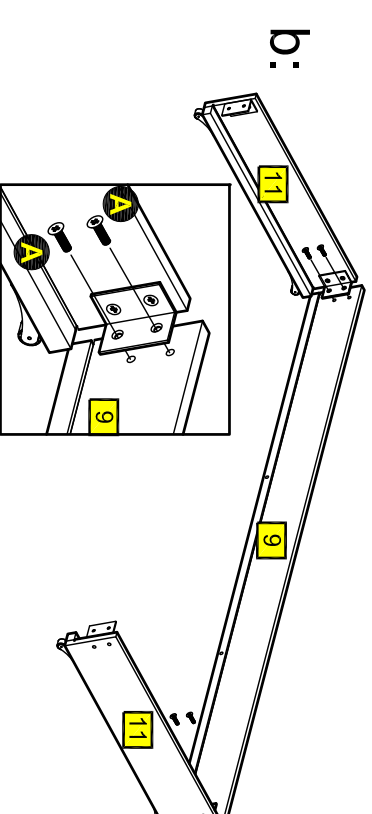

b: Fix the Back board **[9]** to the Side board **[11]** using Bolts **[A]**.

Repeat the operation above with the other Side board **[11]**.

Note: Do not fully tighten bolts.





Note: if required the next page can be cut out and used as reference throughout the assembly. Keep this page with these instructions for future reference.

If you need help or have damaged or missing parts, call the **Customer Helpline: Argos = 0835 6400800**

Components - Fittings

Please check you have all the fittings listed below

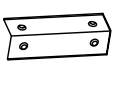
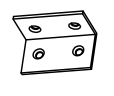
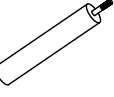
Note: the quantities below are the correct amount to complete the assembly. In some cases more fittings may be supplied than are required.

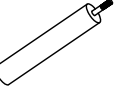
A M6x20 mm Bolt x 28 	B M6x50mm Bolt x 8 	C Leg x 4 
D Angle corner x 2 	E Angle corner x 6 	F Support Leg x 1 
G M6x45mm Bolt x 2 		

Tools required

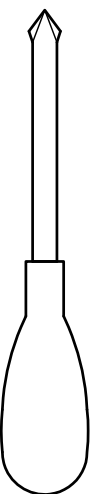

Screwdriver (Not supplied)



Ruler - Use this ruler to help correctly identify the bolts

Assembly Instructions

Step 1

Attaching legs

a: Insert Legs **C** into Headboard **1** and secure tightly to right.

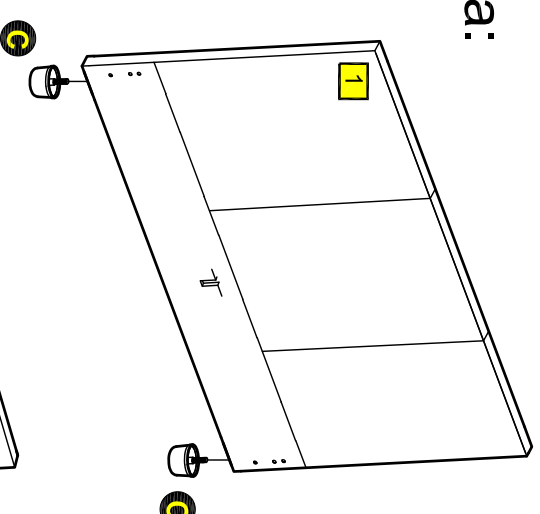

b: Insert Legs **C** into Footboard **2** and secure tightly to right.

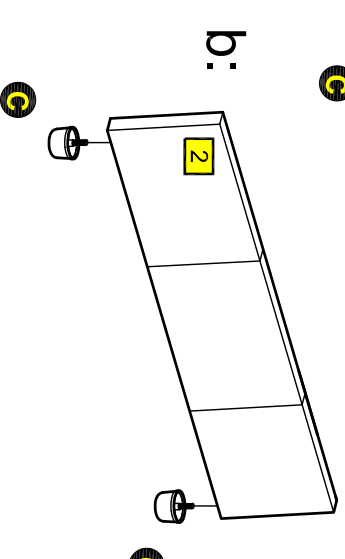

Step 2

Attaching support leg

Insert Support leg **F** in middle of Central support bar **6** and **5**, and rotate to right.

Central Support bar **6** attaches with metal nut down.

It's important that the Support leg **F** do not be tight.

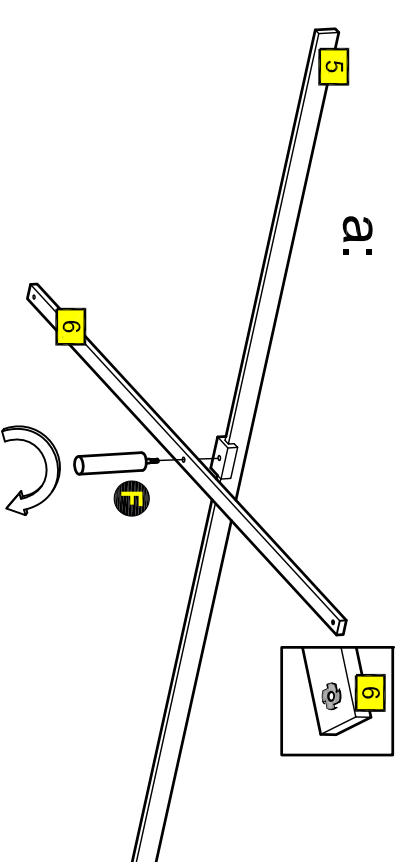

If you need help or have damaged or missing parts, call the **Customer Helpline: Argos = 0835 6400800**

Step 3

Attaching side rails

a: Attach Angle corners **D** to Side rail **3** with Bolts **A**.

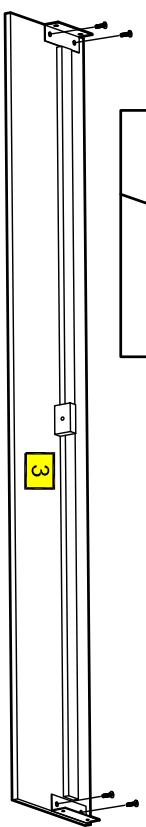
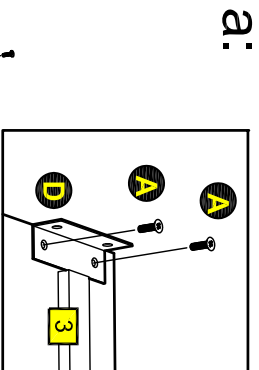

b: Attach Angle corners **E** to Side rail **4** with Bolts **A**.

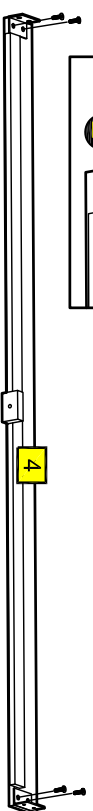
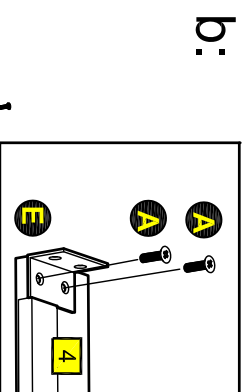

Note: Do not fully tighten bolts.

Step 4

Attaching side rails

With the aid of Bolts **B** fix the Side rails **3** and **4** by Headboard **1** and Footboard **2**.

Now fully tighten all bolts.

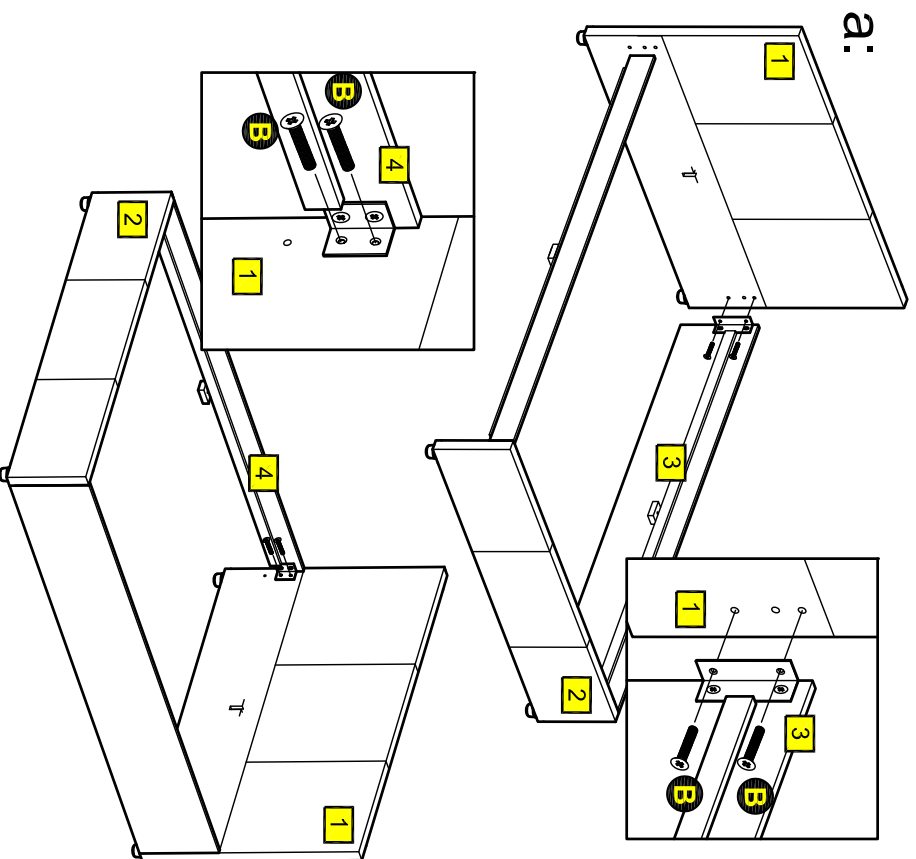

Please check you have all the parts listed below

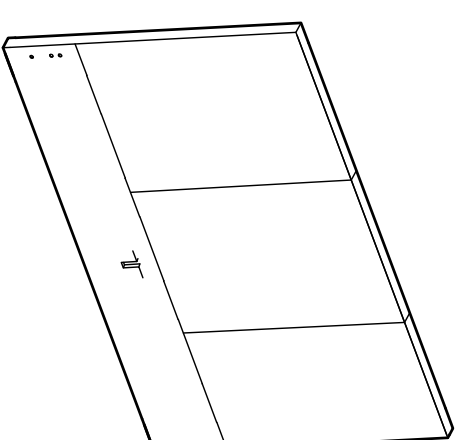

1 Headboard (155x84cm)

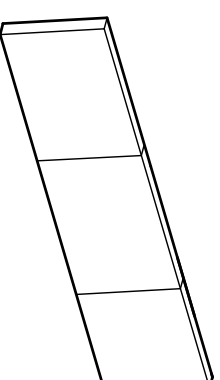

2 Footboard (155x31cm)

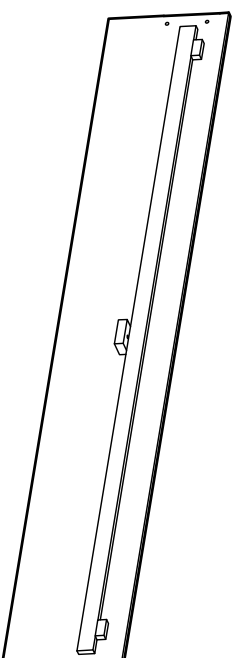

3 Side rail x 1 (202x31cm)

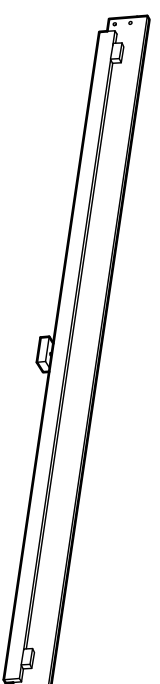

4 Side rail x 1 (202x13.5cm)

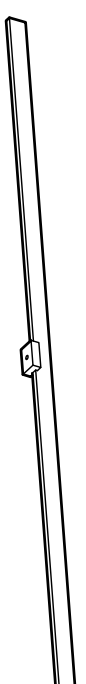

5 Central support bar x 1 (202x4.5cm)



6 Central support bar (151x2.2cm)

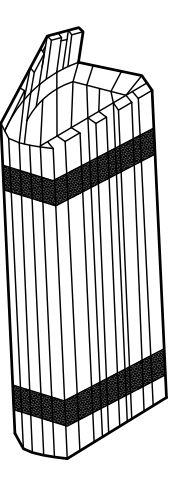

7 Slats (150.5x4.3cm)

Storage drawer

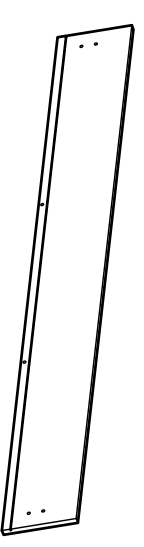

8 Front board x 1 (201x20.5cm)

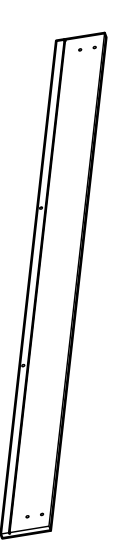

9 Back board x 1 (198x13.6cm)



10 Support bar x 2 (63x2cm)

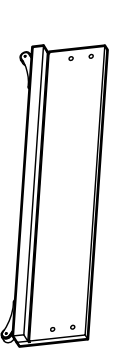

11 Side board x 2 (63x17cm)

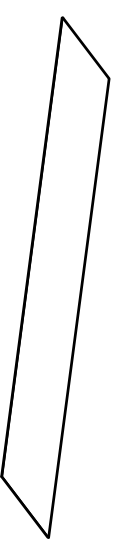

12 Bottom board x 1 (185.8x64cm)

If you need help or have damaged or missing parts, call the Customer Helpline: **Argos = 0835 6400800**

Assembly Instructions

Step 7

Assembling the storage drawer

Two people are needed here.

c: Slide Bottom board **12** into the grooves.

d: Attach Front board **8** by the two Side board **11** with the Bolts **A**.

e: Fix the Support bars **10** to the Front board **8** and Back board **9** with Bolts **A**.

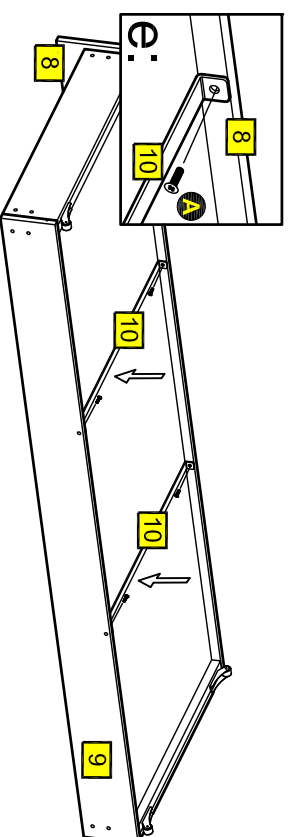
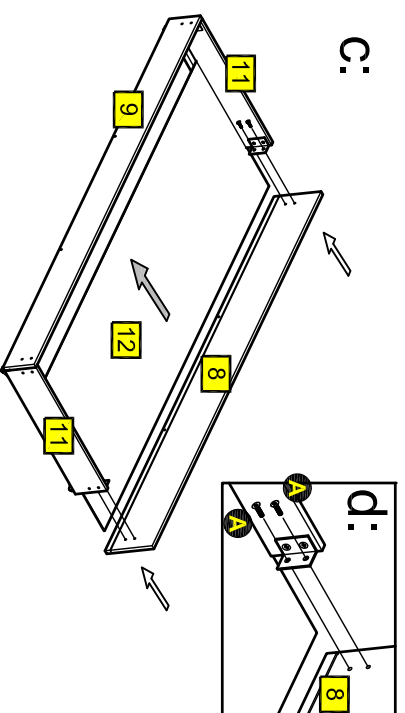

Now fully tighten all bolts

Step 8

Attaching slats

For this stage requires two people.

a: Insert the storage drawer in its place.

b: Roll the slats over the sides **3** and **4**, and connect slats over the wood elements that are attached on both sides of the Side Rails **3** and **4**.

Slats to be rolled out with staples on the underside.

Repeat operation for all 4 corners.

Assembly is now complete.

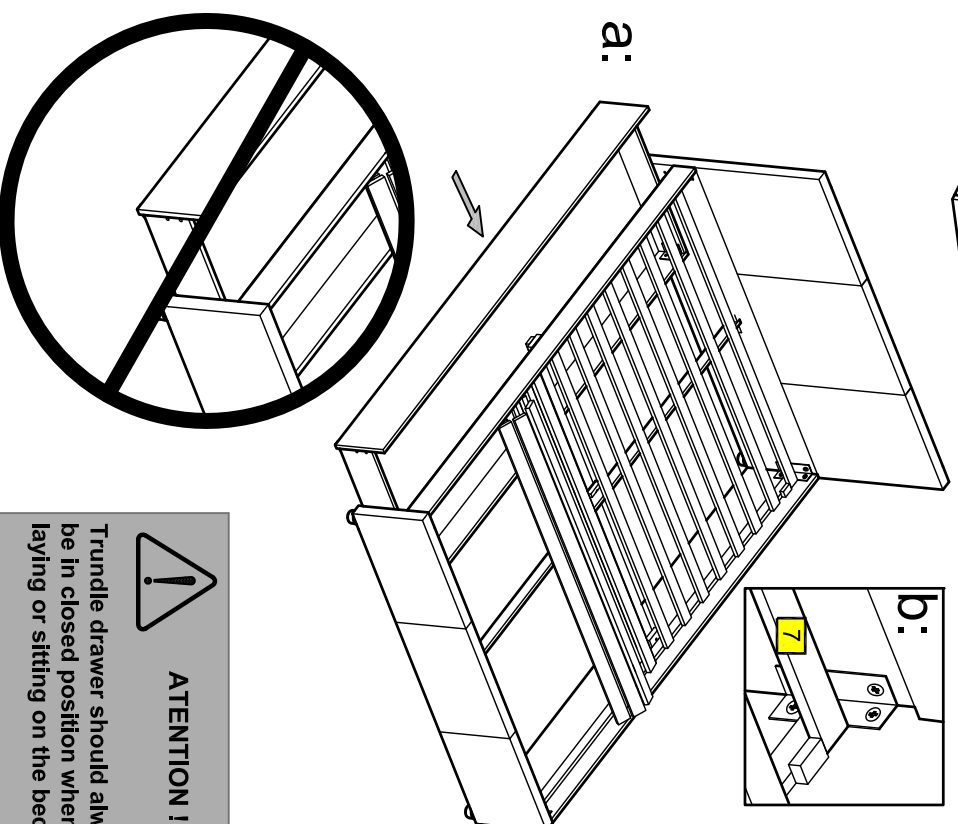

ATTENTION !

Trundle drawer should always be in closed position when laying or sitting on the bed .

If you need help or have damaged or missing parts, call the **Customer Helpline: Argos = 0835 6400800**

Harriette 5FT

Assembly Instructions - Please keep for future reference

Cat.no 248 / 9193

Cat.no 244 / 5151

Cat.no 248 / 7542

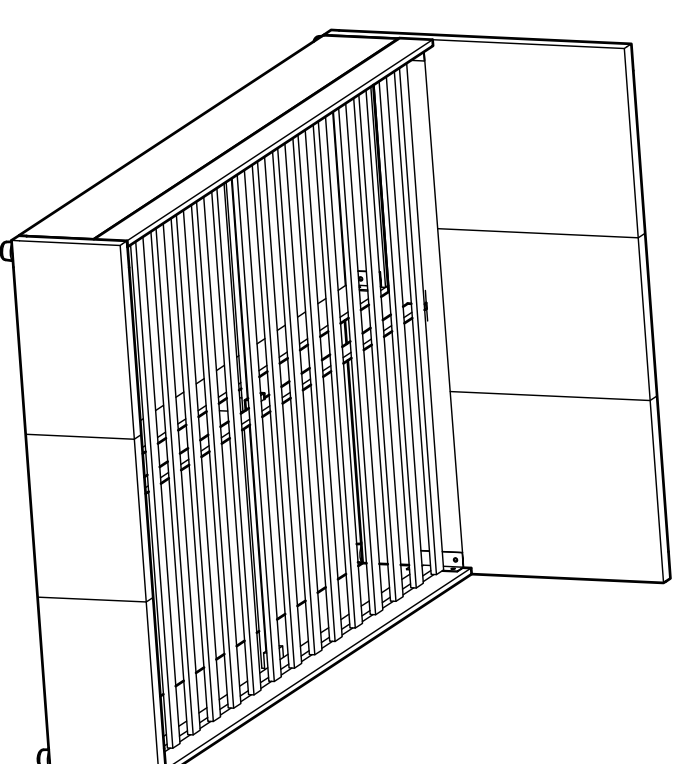

Dimension

Width - 155cm

Length - 213cm

Height - 87cm

Important - Please read these instructions fully before starting assembly

If you need help or have damaged or missing parts, call the **Customer Helpline: Argos = 0835 6400800**



Safety and Care Advice

Important - Please read these instructions fully before starting assembly

- Check you have all the components and tools listed on pages 2 and 3.
- Remove all fittings from the plastic bags and separate them into their groups.
- Keep children and animals away from the work area, small parts could choke if swallowed.
- Make sure you have enough space to layout the parts before starting.
- Do not stand or put weight on the product, this could cause damage.
- Assemble the item as close to its final position (in the same room) as possible.
- Assemble on a soft level surface to avoid damaging the unit or your floor.
- Parts of the assembly will be easier with 2 people.
- We do not recommend the use of power drill/drivers for **inserting screws** as this could damage the unit. Only use hand screwdrivers.
- Dispose of all packaging carefully and responsibly.
- Do not tighten all bolts until bed is fully assembled.



We do not recommend the use of power drill/drivers for **inserting screws** as this could damage the unit. Only use hand screwdrivers.

Care and maintenance

- Only clean using a damp cloth and mild detergent, do no use bleach or abrasive cleaners.
- From time to time check that there are no loose bolts on this unit.
- This product should not be discarded with household waste. Take to your local authority waste disposal centre.

Handy Hints

- Assemble all parts and bolts loosely during assembly, only once the product is complete should you fully tighten the bolts
- Regularly check and ensure that all bolts and fittings are tighten properly.

Assembly Instructions

Step 5

Attaching support bar

a: Enter the ensemble format from Central support bar **[6]**, **[5]** and Support leg **[F]**. Rotate and match the Central support bar **[6]** under central wood element from the Side Rail **[3]** and **[4]**.

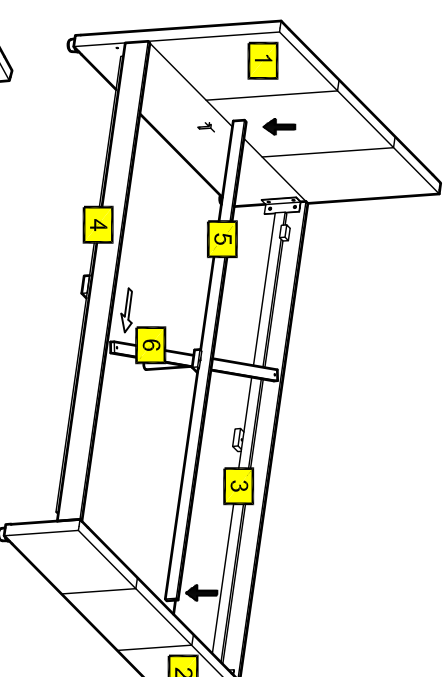
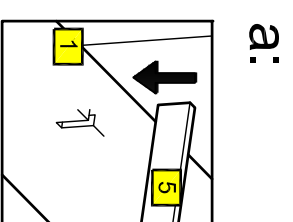

b: Insert Bolt **[G]** through central hole on the Side rail **[3]** and through end holes and secure tightly to right.

Make the same for the other Side rail **[4]**.

Now secure tightly to right the Support leg **[F]**.

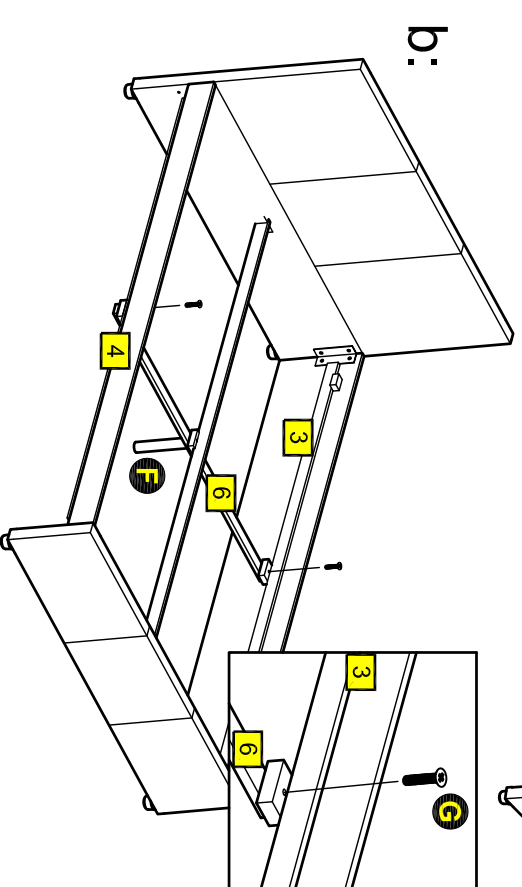

Step 6

Assembling the storage drawer

a: Fix the both Angle corners **[E]** to the Side board **[11]** of the storage drawer with Bolts **[A]**.

Make the same operation with the other side board of the storage drawer **[11]**.

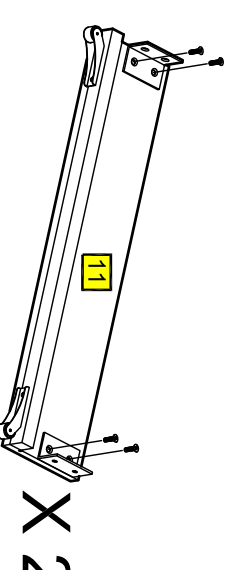
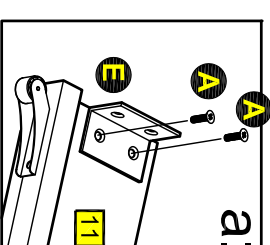

X 2

b:

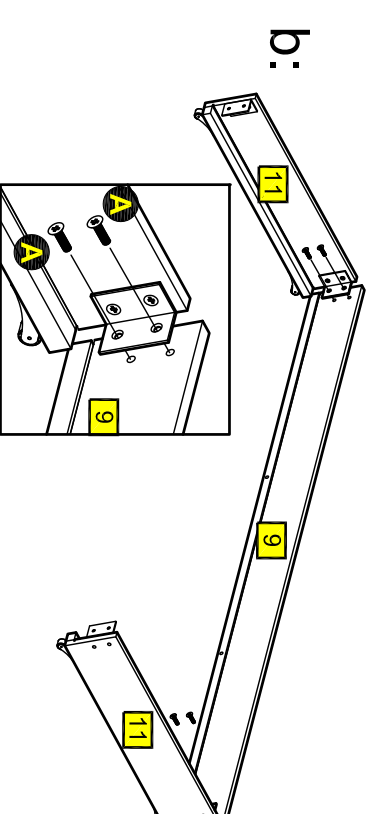

b: Fix the Back board **[9]** to the Side board **[11]** using Bolts **[A]**.

Repeat the operation above with the other Side board **[11]**.

Note: Do not fully tighten bolts.





Note: if required the next page can be cut out and used as reference throughout the assembly. Keep this page with these instructions for future reference.

If you need help or have damaged or missing parts, call the **Customer Helpline: Argos = 0835 6400800**

Components - Fittings

Please check you have all the fittings listed below

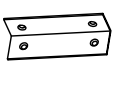
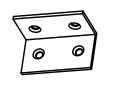
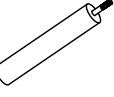
Note: the quantities below are the correct amount to complete the assembly. In some cases more fittings may be supplied than are required.

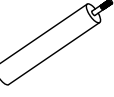
A M6x20 mm Bolt x 28 	B M6x50mm Bolt x 8 	C Leg x 4 
D Angle corner x 2 	E Angle corner x 6 	F Support Leg x 1 
G M6x45mm Bolt x 2 		

Tools required

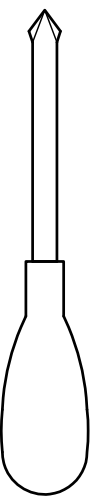

Screwdriver (Not supplied)



Ruler - Use this ruler to help correctly identify the bolts

Assembly Instructions

Step 1

Attaching legs

a: Insert Legs **C** into Headboard **1** and secure tightly to right.

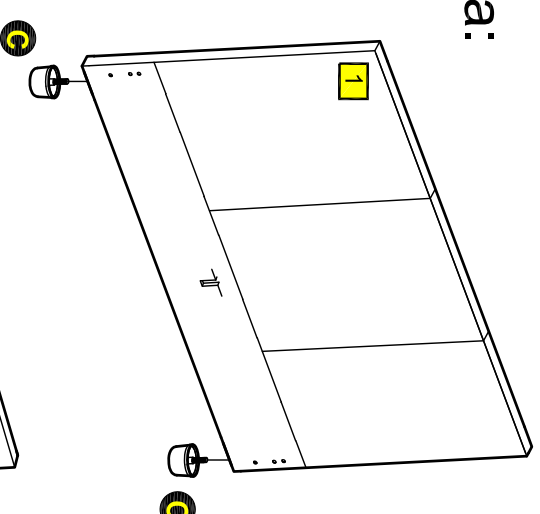

b: Insert Legs **C** into Footboard **2** and secure tightly to right.

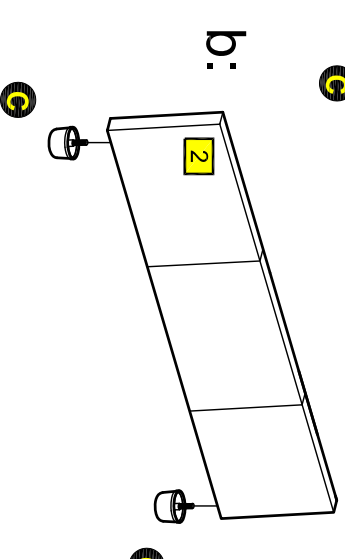

Step 2

Attaching support leg

Insert Support leg **F** in middle of Central support bar **6** and **5**, and rotate to right.

Central Support bar **6** attaches with metal nut down.

It's important that the Support leg **F** do not be tight.

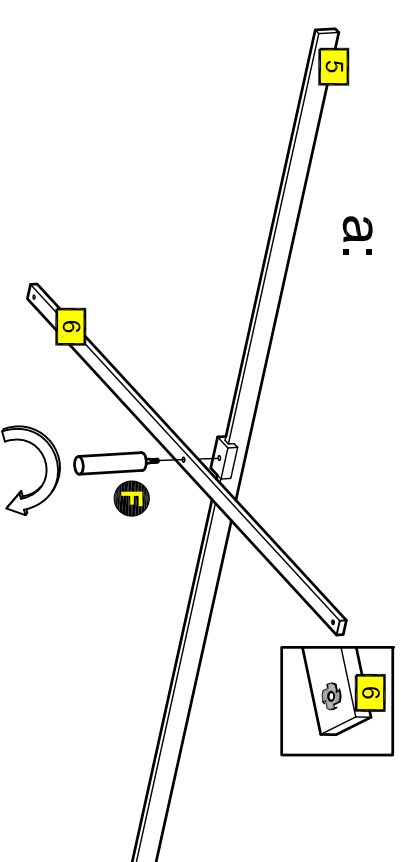

If you need help or have damaged or missing parts, call the **Customer Helpline: Argos = 0835 6400800**

Step 3

Attaching side rails

a: Attach Angle corners **D** to Side rail **3** with Bolts **A**.

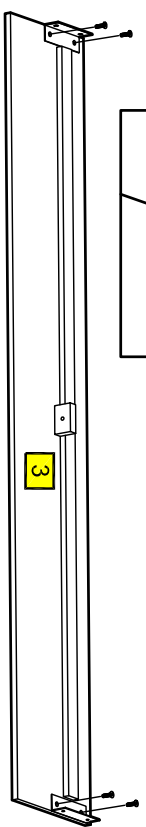
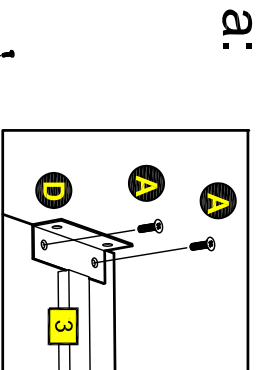

b: Attach Angle corners **E** to Side rail **4** with Bolts **A**.

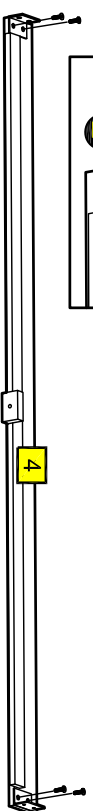
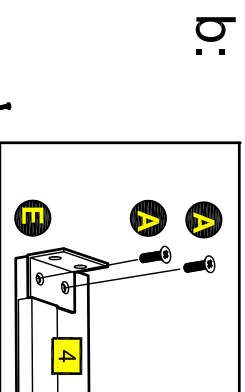

Note: Do not fully tighten bolts.

Step 4

Attaching side rails

With the aid of Bolts **B** fix the Side rails **3** and **4** by Headboard **1** and Footboard **2**.

Now fully tighten all bolts.

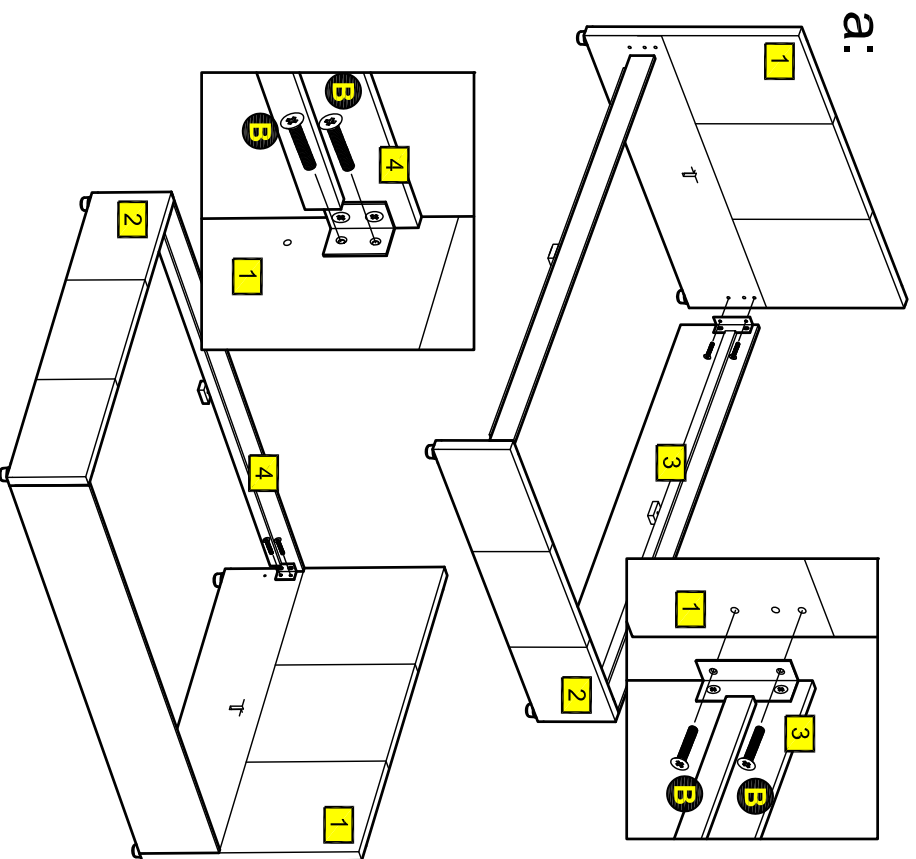

Please check you have all the parts listed below

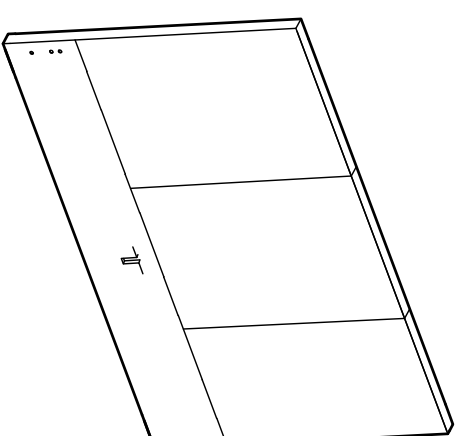

1 Headboard (155x84cm)

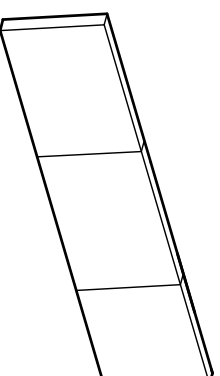

2 Footboard (155x31cm)

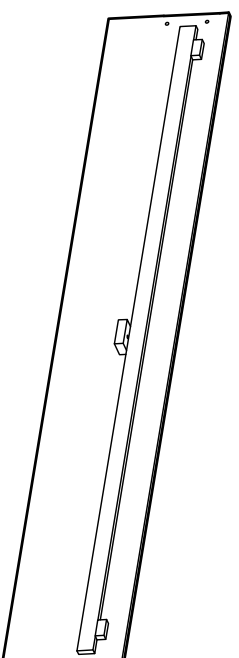

3 Side rail x 1 (202x31cm)

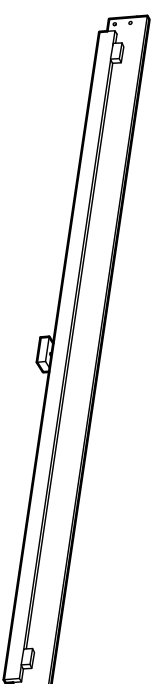

4 Side rail x 1 (202x13.5cm)

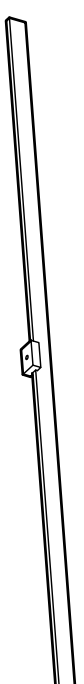

5 Central support bar x 1 (202x4.5cm)



6 Central support bar (151x2.2cm)

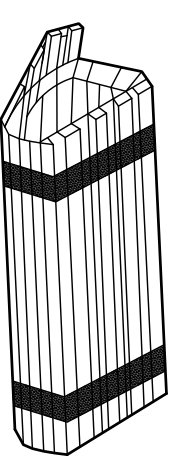

7 Slats (150.5x4.3cm)

Storage drawer

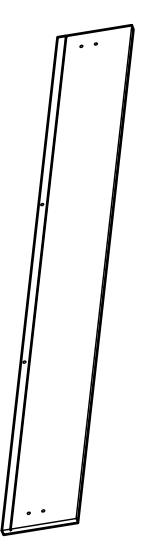

8 Front board x 1 (201x20.5cm)

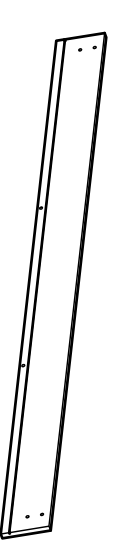

9 Back board x 1 (198x13.6cm)



10 Support bar x 2 (63x2cm)



11 Side board x 2 (63x17cm)

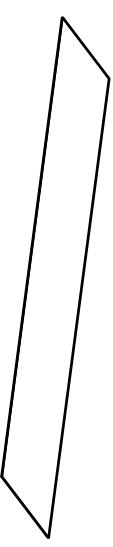

12 Bottom board x 1 (185.8x64cm)

If you need help or have damaged or missing parts, call the Customer Helpline: **Argos = 0835 6400800**