



Register your new Bosch now:  
[www.bosch-home.com/welcome](http://www.bosch-home.com/welcome)



**Washing machine**  
**WA...**



**BOSCH**

**en** Instruction Manual and Installation Instructions

## Your new washing machine

You have chosen a Bosch washing machine.

Please take a few minutes to read and become familiar with the advantages of your washing machine.

To meet the high quality demands required by Bosch, every washing machine that leaves our factory is carefully checked to ensure that it functions correctly and is in perfect condition.

For more information on our products, accessories, replacement parts and services, see our website [www.bosch-home.com](http://www.bosch-home.com) or contact our after-sales service centres.

If the operating and installation instructions describe different models, any differences will be pointed out at the relevant points in the text.



Read these operating and installation instructions before switching on the washing machine.

## Display rules

### **Warning!**

This combination of symbol and signal word indicates a possibly dangerous situation. Not heeding the warning can cause death or injuries.

### **Caution!**

This signal word indicates a possibly dangerous situation. Not heeding the caution can cause property and/or environmental damage.

### **Note/tip**

Information about the optimum use of the appliance/any other useful information.

### **1. 2. 3. / a) b) c)**



The steps are represented by numbers or letters.

■ / -

Lists are represented by a small box or a dash.

# Contents

 <b>Intended use</b> . . . . .	4	 <b>Operating the appliance</b> . . . . .	13
 <b>Safety instructions</b> . . . . .	5	Preparing the washing machine . . . . .	13
Electrical safety . . . . .	5	Select programme/switch on the appliance . . . . .	13
Risk of injury . . . . .	5	Change the programme default settings . . . . .	13
Safety for children . . . . .	5	Placing laundry into the drum . . . . .	14
 <b>Environmental protection</b> . . . . .	6	Measure and add detergent and care products . . . . .	14
Packaging/used appliance . . . . .	6	Start the programme . . . . .	15
Tips on economical use . . . . .	6	Childproof lock . . . . .	16
 <b>Getting to know the appliance</b> . . . . .	7	Adding laundry . . . . .	16
Washing machine . . . . .	7	Changing the programme . . . . .	16
Control panel . . . . .	8	Cancel the programme . . . . .	16
Display panel . . . . .	8	Programme end . . . . .	16
 <b>Laundry</b> . . . . .	9	Removing laundry/switching off the appliance . . . . .	17
Prepare the laundry . . . . .	9	 <b>Sensors</b> . . . . .	17
Sorting laundry . . . . .	9	Automatic load sensing . . . . .	17
Starching . . . . .	10	Unbalanced load detection system . . . . .	17
Dyeing/bleaching . . . . .	10	 <b>Setting the signal</b> . . . . .	18
Soaking . . . . .	10	 <b>Cleaning and maintenance</b> . . . . .	19
 <b>Detergent</b> . . . . .	10	Machine housing/control panel . . . . .	19
Correct selection of detergent . . . . .	10	Drum . . . . .	19
Saving energy and detergent . . . . .	11	Descaling . . . . .	19
 <b>Programme default settings</b> . . . . .	11	Detergent drawer and housing . . . . .	19
Spin speed . . . . .	11	Detergent solution pump blocked . . . . .	20
Ready in time . . . . .	12	The drain hose at the siphon is blocked . . . . .	21
 <b>Additional programme settings</b> . . . . .	12	Filter in the water supply blocked . . . . .	21
Speed Perfect  . . . . .	12	 <b>Faults and what to do about them</b> . . . . .	21
Eco Perfect  . . . . .	12	Emergency release . . . . .	21
Rinse plus . . . . .	12	Information on the display panel . . . . .	22
Water Plus . . . . .	12	Faults and what to do about them . . . . .	23
Easy Iron . . . . .	12		

	After-sales service . . . . .	24
	Technical data . . . . .	25
	Positioning and connecting. . . . .	25
	Included with the appliance . . . . .	25
	Safety instructions . . . . .	26
	Installation surface . . . . .	26
	Installation on a base or a wooden joist floor . . . . .	26
	Installation on a platform with drawer . . . . .	26
	Installing the appliance in a kitchenette . . . . .	26
	Removing the transport locks . . . . .	27
	Hose and cable lengths . . . . .	27
	Water inlet . . . . .	28
	Water outlet . . . . .	29
	Levelling . . . . .	30
	Electrical connection . . . . .	30
	Before washing for the first time . . . . .	31
	Transportation . . . . .	31

---

## Intended use

- For private domestic use only.
- The washing machine is suitable for washing machine-washable fabrics and hand-washable wool in water containing detergent.
- To be operated with cold\* mains water or cold and hot\* mains water (max. 60 °C), and standard detergents and care products which are suitable for use in washing machines.
- When measuring out the amount of all detergents, additives, care products and cleaning agents, always follow the manufacturer's instructions.
- The washing machine may be used by children over the age of 8 years and by persons with reduced physical, sensory or mental capacity or by persons with a lack of experience or knowledge if they **are supervised** or have been **instructed** by a responsible person. Children must not carry out any cleaning or maintenance work without supervision.
- This appliance is intended for use up to a maximum height of 4000 metres above sea level.
- Keep children under the age of 3 years away from the washing machine.
- Keep pets away from the washing machine.

Read the Instruction Manual and Installation Instructions and all other information supplied with the washing machine and use the machine accordingly.

Retain the documents for subsequent use.

\* depending on the model

## **Safety instructions**

### **Electrical safety**

#### **Warning**

#### **Danger of death!**

There is a risk of electric shock if you touch live components.

- Never touch or hold the mains plug with wet hands.
- Only pull out the mains cable by the plug and never by the cable, as this could damage it.

### **Risk of injury**

#### **Warning**

#### **Risk of injury!**

- When the washing machine is lifted by its protruding parts (e.g. the washing machine door), the components may break off and cause injuries. Do not lift the washing machine by protruding parts.
- If you climb on the washing machine, the worktop may break and cause injuries. Do not climb onto the washing machine.
- If you lean on the washing machine door when it is open, the washing machine may tip over and cause injuries. Do not lean on the washing machine door when it is open.

- Reaching into the drum when it is turning can cause injuries to hands. Do not reach into the drum when it is turning. Wait until the drum has stopped turning.

#### **Warning**

#### **Risk of scalding!**

When you are washing at high temperatures, there is a risk of scalding if you come into contact with hot water e.g. if hot water is being drained into a wash basin.

Do not reach into the hot detergent solution.

### **Safety for children**

#### **Warning**

#### **Danger of death!**

If children play with the washing machine, they may get into life-threatening situations or injure themselves.

- Do not leave children unattended near the washing machine.
- Do not let children play with the washing machine.

#### **Warning**

#### **Danger of death!**

Children may lock themselves in appliances, putting their lives at risk.

For appliances that have reached the end of their service life:

- Disconnect the mains plug.

- Cut through the mains cable and remove it, along with plug.
- Destroy the lock on the washing machine door.

 **Warning**

**Risk of suffocation!**

Children may become wrapped in packaging/film or packing parts if allowed to play with them, or they may pull them over their heads and suffocate. Keep packaging, film and packaging parts out of the reach of children.

 **Warning**

**Risk of poisoning!**

Detergents and care products may be poisonous if consumed. Keep detergents and care products out of the reach of children.

 **Warning**

**Eye/skin irritation!**

Detergents and care products may cause irritation if they come into contact with the eyes or skin. Keep detergents and care products out of the reach of children.

 **Warning**

**Risk of injury!**

When you wash at high temperatures, the glass in the washing machine door gets hot. Do not let children touch the hot washing machine door.



## Environmental protection

### Packaging/used appliance



Dispose of packaging in an environmentally-responsible manner.

This appliance is labelled in accordance with European Directive 2012/19/EU concerning used electrical and electronic appliances (waste electrical and electronic equipment - WEEE).

The guideline determines the framework for the return and recycling of used appliances as applicable throughout the EU.

### Tips on economical use

- Always fill the appliance with the maximum amount of laundry for each programme. Overview of programmes →: Supplementary sheet for the operating and installation instructions.
- Wash normally soiled laundry without a prewash.
- The selectable temperatures apply to the care labels on the textiles. The temperatures in the machine may deviate from this so that you get the optimum mix of energy-saving and washing results.
- **Energy-saving mode:** The display panel light goes out after several minutes, Start button flashes. To activate the light, press any button. Energy-saving mode is not activated if a programme is running.
- If the laundry is subsequently dried in a tumble dryer, select the spin speed according to the tumble dryer manufacturer's instructions.

# Getting to know the appliance

## Washing machine

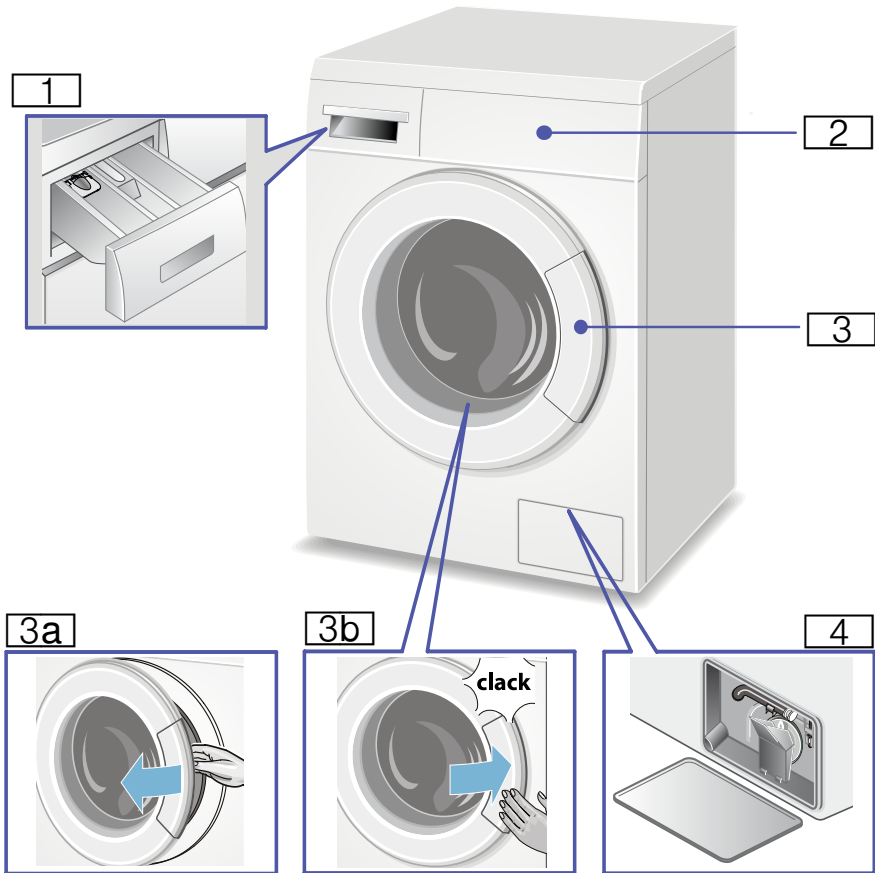

**1** Detergent drawer

**2** Control/display panel

**3** Washing machine door with handle

**3a** Open the washing machine door

**3b** Close the washing machine door

**4** Service flap with or without a drainage hose\*

\* Depending on the model

en Getting to know the appliance

## Control panel

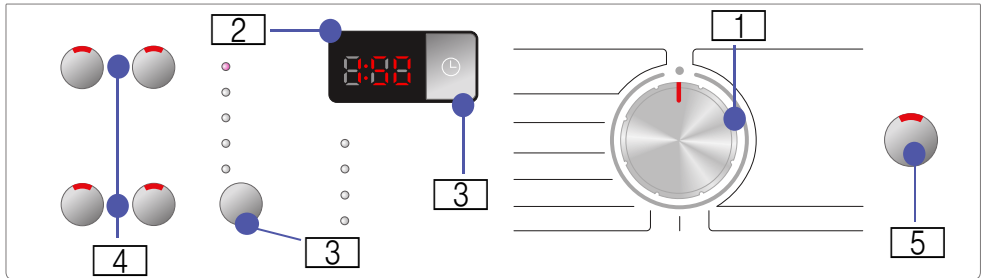

**Note:** You can find possible programme default settings and additional programme settings in the overview; these differ depending on the model.



**1 Programme selector** for selecting a programme and switching the machine on and off via the "Off" position.

**2 Display panel** for settings and information.



**3 Programme default settings:** Spin speed and "Ready in" time. Changing the programme default settings → *Page 11*.

**4 Additional programme settings** : Speed Perfect , Eco Perfect , Easy Iron, Water Plus or Rinse Plus. Selecting additional programme settings → *Page 12*.

**5 Start button** for starting, interrupting (e.g. to reload laundry) and cancelling a programme.

## Display panel

**Note:** The table shows possible setting options and information in the display panel; these differ depending on the model.

Setting options and information for the selected programme		
 / Rinse stop ... 1400 	Spin speed	in rpm (revolutions per minute);  / Rinse stop
1:30	Programme duration	Depends on the programme selection in h:min (hours:minutes)
1 - 24 h	Ready in time	Programme ends after ... h (h = hours)
8.0 kg	Max. load	in kg (kilograms)

### Notes

 : Childproof lock .





## Laundry

### Prepare the laundry

#### Caution!

#### Damage to the appliance/fabrics

Foreign objects (e.g. coins, paperclips, needles, nails) may damage the laundry or components in the washing machine.

You should therefore note the following tips when preparing your laundry:

- Empty any pockets.

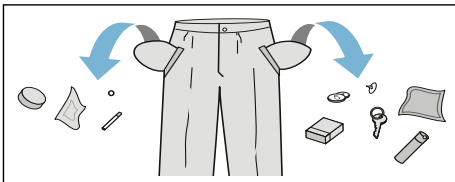







- Look out for metal items (paperclips, etc.) and remove them.
- Wash delicates in a laundry bag (tights, underwired bras, etc.).
- Close any zips; button up any cover buttons.
- Brush sand out of pockets and collars.
- Remove curtain fittings or place curtains in a laundry bag.

### Sorting laundry

Sort your laundry according to the care instructions and manufacturer's information on the care labels, depending on:

- Type of fabric/fibre.
- Colour:
  - Note:** Laundry may discolour or not be cleaned correctly. Wash white and coloured items separately. Wash new bright fabrics separately the first time you wash them.

- Soiling:
  - Wash laundry with the same level of soiling together.
  - Examples of levels of soiling:
    - **Light:** Do not prewash; if necessary, select the additional programme setting SpeedPerfect = .
    - **Normal**
    - **Heavy:** Load less laundry, select a programme with prewash
    - **Stains:** Remove/pretreat stains while they are fresh. First, dab the stain with soapy water/do not rub. Then wash the items of laundry with the appropriate programme. Stubborn or dried-in stains can sometimes only be removed by washing several times.
- Symbols on the care labels:
  - The numbers in the symbols indicate the maximum washing temperature that may be used.
  - : Suitable for a normal washing process; e.g. Cottons programme.
  - : A gentle washing process is required; e.g. Easy-Care programme.
  - : An especially gentle washing process is required; e.g. Delicate/Silk programme
  - : Suitable for washing by hand; e.g.  Wool programme.
  - : Do not wash the laundry in the machine.

## Starching

**Note:** Laundry must not be treated with fabric softener.

Starching is possible in all wash programmes if liquid starch is used. Measure starch into compartment  in accordance with the manufacturer's instructions (clean first if necessary).

## Dyeing/bleaching

Dye should only be used in normal household quantities. Salt may damage stainless steel. Always follow the dye manufacturer's instructions.

Do **not** use the washing machine to bleach clothes.

## Soaking

1. Pour soaking agent/detergent into compartment **II** according to the manufacturer's instructions.
2. Turn the programme selector to the Cottons 30 °C programme.
3. Press the start button.
4. After approx. 10 minutes, press the start button again to pause the programme.
5. After the required soaking time, press the start button again, if the programme is to be continued or changed.

### Notes

- Load laundry of the same colour.
- No additional detergent is required; the soaking solution is used for washing.

---

## Detergent

### Correct selection of detergent

The care label is crucial for selecting the correct detergent, temperature and treatment of the laundry. → See also [www.sartex.ch](http://www.sartex.ch)

Visit [www.cleanright.eu](http://www.cleanright.eu) to find further information on detergents, care products and cleaning agents for domestic use.

- **Standard detergent with optical brighteners**  
Suitable for heat-resistant white laundry made from linen or cotton. Select the Cottons / cold - max. 90 °C programme.
- **Detergent for colours without bleach or optical brighteners**  
Suitable for coloured laundry made from linen or cotton. Select the Cottons / cold - max. 60 °C programme.
- **Detergent for colours/delicates without optical brighteners**  
Suitable for coloured laundry made from easy-care fibres, synthetic fibres. Select the Easy-Care / cold - max. 60 °C programme.
- **Mild detergent**  
Suitable for delicate, fine fabrics, silk or viscose. Select the Delicate/Silk / cold - max. 40 °C programme.
- **Detergent for woollens**  
Suitable for woollen fabrics. Select the Wool / cold - max. 40 °C programme.

## Saving energy and detergent

For light and normal soiling, you can save energy (lower washing temperature) and detergent.

Saving	Soiling/note
 <p>Reduced temperature and detergent quantity as per the recommended dosage</p> <p>Temperature as per the care label and detergent quantity as per the recommended dosage for heavy soiling</p>	<p><b>Light</b> No visible dirt or stains. Clothing has taken on some body odour, e.g.:</p> <ul style="list-style-type: none"> <li>■ Light summer/sports clothing (worn for a few hours)</li> <li>■ T-shirts, shirts, blouses (worn for up to one day)</li> <li>■ Guest bed linen and hand towels (used for one day)</li> </ul>
	<p><b>Normal</b> Visible dirt or a few light stains, e.g.:</p> <ul style="list-style-type: none"> <li>■ T-shirts, shirts, blouses (sweat soaked, worn a few times)</li> <li>■ Towels, bedding (used for up to one week)</li> </ul>
	<p><b>Heavy</b> Dirt and/or stains clearly visible, e.g. tea towels, baby items, work clothing</p>

**Note:** When measuring the amount of all detergents/additives/care products and cleaning agents, please always check the manufacturer's instructions and information. → Page 14

## P+ Programme default settings

**Note:** You can find possible programme default settings in the overview; these differ depending on the model.

The programme default settings for all programmes are preset at the factory and are displayed in the display panel after the programme is selected.

### Spin speed

(Centrifug.; Ⓢ)

Depending on the programme progress, you can change the spin speed (in rpm; revolutions per minute) before and during the programme.

To do this, press the spin speed button repeatedly until the required spin speed is displayed in the display panel. The maximum speed that can be selected depends on the model and programme that has been selected.

Setting ☹: Rinse hold. The laundry remains in the water after the final rinse to prevent creasing if the laundry will not be taken out of the washing machine immediately.

## Ready in time



**Before starting the programme**, the programme end Ready in time can be preselected in hourly increments (h = hours) up to a maximum of 24 hours.

1. Select the required programme.  
**Note:** The programme duration is displayed in the display panel.
2. Press the Ready in button repeatedly until the required number of hours is displayed in the display panel.
3. Press the Start button.

The set Ready in time is now active. The selected programme starts automatically and ends after the selected number of hours.

After the programme has started, the programme duration, e.g. 2:30 (hours:minutes) is displayed in the display panel.

### Adding laundry after the "Ready in" time is active:

1. Press the Start button.
2. **YES** lights up in the display panel. The washing machine door can be opened and laundry can be added.
3. Close the washing machine door.
4. Press the Start button again. The preselected time continues to run.

---

## **P+** Additional programme settings

**Note:** You can find possible additional programme settings in the overview; these differ depending on the model.

### Speed Perfect

( **Speed Perfect**; **Turbo Perfect**)

Washes in a shorter time but with a washing outcome comparable to that of the programme without selecting the additional Speed Perfect/  
Turbo Perfect programme setting.

**Note:** Do not exceed the maximum load for the programme. See the supplementary sheet for the operating and installation instructions; programme overview.

## Eco Perfect

(**Eco Perfect**

Energy-optimised washing by reducing the temperature while achieving washing result that is consistent with the standard program.

**Note:** The washing temperature is lower than the selected temperature. The Allergie/Hygiene/Sensitive program is recommended for washes with particularly high hygienic requirements. If you do not have an Allergy/Hygiene/Sensitive program on the program selector, select a higher temperature or select the additional preset Speed Perfect program.

## Rinse plus

(**Extra** )

Extra rinse. For areas with very soft water or for an even better rinsing result.

## Water Plus

()

Increased water level and additional rinse cycle, extended washing time. For areas with very soft water or for an even better rinsing result.

## Easy Iron

(**Fácil** )

For gentle final spin with subsequent fluffing. Residual moisture in the laundry is slightly increased.



## Operating the appliance

### Preparing the washing machine

**Note:** The washing machine **must be correctly installed** and **connected**.  
From → *Page 25*.

1. Plug in the mains plug.
2. Turn the tap on.
3. Open the washing machine door.
4. Check that the drum is completely drained. Drain if necessary.

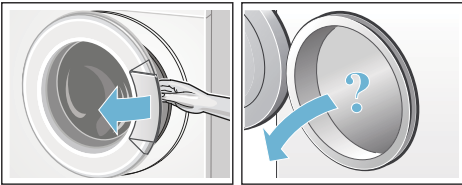

### Select programme/switch on the appliance

**Note:** If you have activated the childproof lock, you must first deactivate it before you can set a programme.  
→ *Page 16*.

Use the programme selector to select the required programme. Can be rotated in either direction.

The appliance is switched on.

The programme default settings and loading information for the selected programme appear in the display panel:

- The programme duration,
- The preset spin speed and
- The maximum load.

### Change the programme default settings

You can change the programme default settings:

To do this, repeatedly press the required button for the programme default settings until the required setting is displayed in the display panel. Then press the "Start" button to start the programme.

The programme default settings are not saved when the appliance is switched off.

Programme default settings  
→ *Page 11*.

## Placing laundry into the drum

### **Warning** **Risk of death!**

Items of laundry pretreated with cleaning agents that contain solvents, e.g. stain remover/cleaning solvent, may cause an explosion after being loaded into the washing machine. Hand-rinse these items of laundry thoroughly beforehand.

### Notes

- Mix items of laundry of varying sizes. Laundry items of different sizes distribute themselves better during the spin cycle. Individual items of laundry may lead to imbalances.
  - Observe the maximum specified load. Overfilling has a negative impact on the washing result and promotes creasing.
1. Unfold presorted items of laundry before placing them in the washing drum.
  2. Make sure that no items of laundry are trapped between the washing machine door and the rubber seal, and close the door.

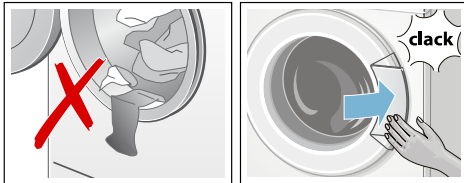

## Measure and add detergent and care products

### Caution!

### Damage to the appliance

Cleaning agents and agents for pretreating laundry (e.g. stain removers, prewash sprays, etc.) may cause damage if they come into contact with the surfaces of the washing machine. Do not allow these agents to come into contact with the surfaces of the washing machine. If necessary, immediately wipe away spray residue and other residues/droplets with a damp cloth.

### Measuring

Dose the detergents and care products according to:

- Water hardness. Ask your water supply company.
- The manufacturer's specifications on the packaging.
- The amount of laundry.
- Soiling → *Page 9*.

## Filling

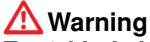

### Warning

#### Eye/skin irritation!

Detergent and care products may spray out if the detergent drawer is opened while the machine is in operation.

Open the drawer carefully.

Rinse eyes or skin thoroughly if they come into contact with detergent/care products.

If swallowed accidentally, seek medical advice.

**Note:** Dilute viscous fabric softener and fabric conditioner with water; this prevents blockages.

Pour the detergent and care products into the appropriate compartments:

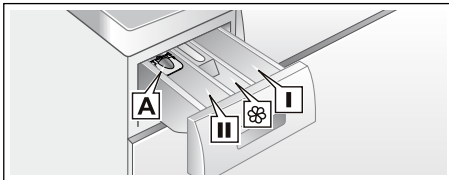

Measuring aid\* **A** For liquid detergent

Compartment **II** Detergent for the main wash, water softener, bleach, stain remover

Compartment  Softener, starch, do not exceed the maximum

Compartment **I** Detergent for prewash

1. Pull out the detergent drawer as far as possible.
2. Add detergent and/or care products.
3. Close the detergent drawer.

## Measuring aid\* for liquid detergent

\*Depending on the model

Position the measuring aid for measuring liquid detergent:

1. Pull out the detergent drawer. Press down the insert and fully remove the drawer.
2. Slide the measuring aid forwards, fold it down and click it into place.
3. Reinsert the drawer.

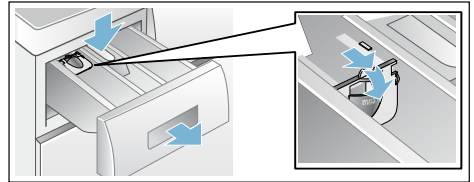

**Note:** Do not use the measuring aid for gel detergents and washing powder, or for programmes with prewash or when the Ready in time is selected.

**For models without a measuring aid,** pour the liquid detergent into the appropriate dispenser and place it in the drum.

## Start the programme

Press the Start button to start the programme.

During the programme, the display panel shows the Ready in time or, after starting the wash programme, the programme duration and the symbols for the programme progress. Display panel → Page 8.

**Note:** To secure the programme against being inadvertently adjusted, select the childproof lock.

## Childproof lock

Prevent the set functions of the washing machine from being accidentally changed by activating the childproof lock when the programme has started.

To **activate** the childproof lock, press and hold the "Start" button for approx. five seconds.  appears in the display panel and then goes out again after a few seconds.

To **deactivate** the childproof lock, press and hold the "Start" button for approx. five seconds.

### Notes

-  lights up: The childproof lock is active and the programme selector has been adjusted. To prevent the programme from stopping, turn the programme selector back to the original programme.
- The childproof lock remains active after the programme has ended and the appliance is switched off. You must always deactivate the childproof lock if you want to start a new programme.

## Adding laundry

After starting the programme, you can add or remove laundry:

1. Press the "Start" button to pause the programme.

The "Start" button indicator lamp flashes and the machine checks whether it is possible to add laundry.

**Note:** Do not leave the washing machine door open for too long when adding laundry as water from the laundry may leak out.

If the following appears in the display panel:

- **YES** lights up, it is possible to add laundry.

- **NO** flashes, wait until **YES** lights up.  
Only open the washing machine door if **YES** is lit up.
- **NO** lights up, it is not possible to add laundry.

For safety reasons, the washing machine door remains locked when the water level or temperature is high, or while the drum is rotating, and it is not possible to add laundry during this time.

2. To continue the programme, press the "Start" button again.

## Changing the programme

1. Press the Start button to pause the programme.
2. Select a different programme.
3. Press the Start button again. The new programme starts from the beginning.

## Cancel the programme

1. Press the Start button to cancel the programme.
2. To cool the laundry: Set the programme to Rinse.
3. Press the Start button again. The rinse programme starts.

After the programme has ended, you can remove the laundry.

## Programme end

 appears in the display panel and the start button indicator lamp is off.

If the  symbol also appears in the display panel, the washing machine has detected too much foam during the wash programme and automatically switched on a rinse cycle to remove the foam.

**Note:** Add less detergent for the next washing cycle with the same load.



## Removing laundry/switching off the appliance

1. Open the washing machine door and remove the laundry.

### Notes

- If you cannot open the washing machine door, the appliance is still locked. Wait until the programme ends.
  - If the display panel does not light up, energy-saving mode is active. To activate, select any button.
2. Set the programme selector to the Off position. The appliance is switched off.
  3. Turn off the tap.

**Note:** Not required for Aqua-Stop models.

### Notes

- Do not leave any items of laundry in the drum. They may shrink in the next wash or discolour another item.
- Remove any foreign objects from the drum and the rubber seal – risk of rusting.

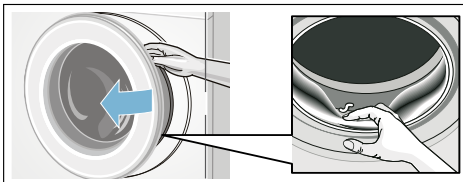

- Leave the washing machine door and detergent drawer open so that any residual water can dry away.

## Sensors

### Automatic load sensing

The automatic load sensing function adapts the water consumption ideally to each programme depending on the type of fabric and the load.

### Unbalanced load detection system

The automatic unbalanced load detection system detects imbalances and ensures even distribution of the laundry by repeatedly starting and stopping drum spinning.

If the laundry is extremely unevenly distributed, the speed is reduced or the spin cycle is not performed for safety reasons.

**Note:** Place large and small items of laundry evenly in the drum. → *Page 23*

## Setting the signal

### 1. Set the button and information signals

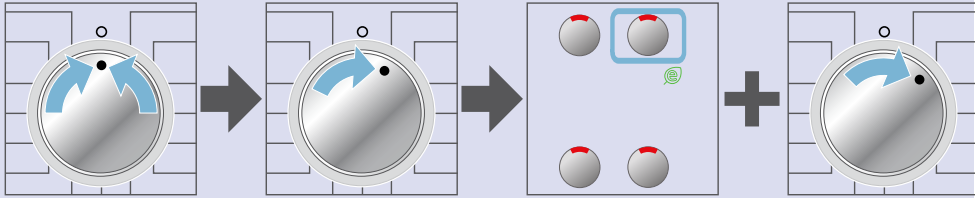

Set the programme selector to the "Off" position and then turn the dial one position to the right.

Press the button for Eco Perfect , hold it down and, at the same time, turn the programme selector one further position to the right.

### 2. Set the volume for button signals

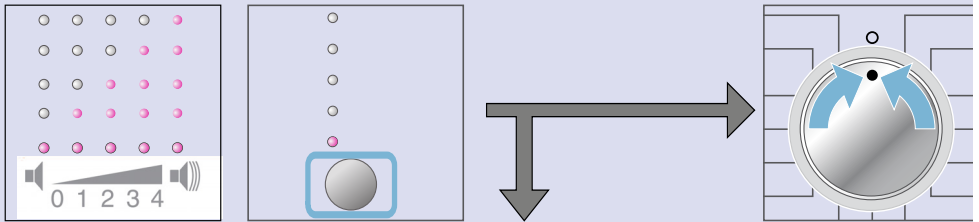

The current signal volume now appears. Press the spin speed button repeatedly until the required signal volume is set.

Go to point **3** to set the volume for the information signals, **or**

Set the programme selector to the "Off" position to exit the menu.

### 3. Set the volume for the information signals

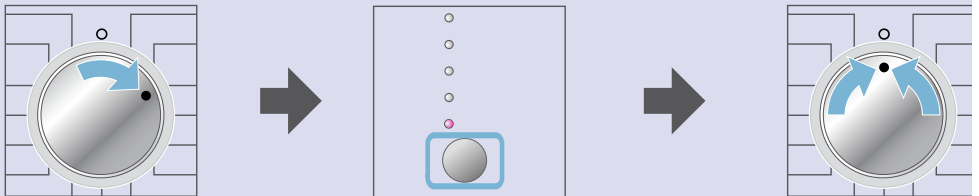

Turn the programme selector one further position.

Press the spin speed button repeatedly until the required information signal volume is reached.

Set the programme selector to the "Off" position to exit the menu.



## Cleaning and maintenance

### Warning

#### **Danger of death!**

There is a risk of electric shock if you touch live components. Switch off the appliance and unplug the mains plug.

### Warning

#### **Risk of poisoning!**

Toxic vapours can be produced by cleaning agents that contain solvents, e.g. cleaning solvent. Do not use cleaning agents that contain solvents.

### **Caution!**

#### **Damage to the appliance**

Cleaning agents that contain solvents, e.g. cleaning solvent, can damage surfaces and components in the machine. Do not use cleaning agents that contain solvents.

## Machine housing/control panel

- Wipe the housing and the control panel with a soft, damp cloth.
- Remove the detergent residue immediately.
- Do not clean with a water jet.

## Drum

Use chlorine-free cleaning agents and not steel wool.

## Descaling

Descaling should not be necessary if the detergent is measured out correctly. However, if it is required, follow the manufacturer's instructions for the descaling agent. Suitable descalers can be obtained via our website or from our after-sales service.

## Detergent drawer and housing

If the washing machine contains detergent or fabric softener residues:

1. Pull out the detergent drawer. Press down the insert and fully remove the drawer.
2. To remove the insert: Push the insert upwards from below with your finger.

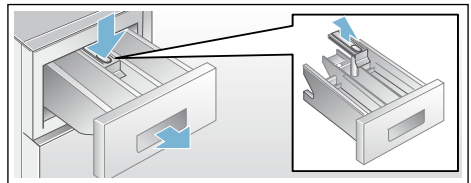

3. Clean the detergent dispenser tray and insert with water and a brush, and dry it. Clean the inside of the housing as well.
4. Fit the insert and lock it in place (push the cylinder onto the guide pin).
5. Push in the detergent drawer.

**Note:** Leave the detergent drawer open so that any residual water can evaporate.

## Detergent solution pump blocked

### **Warning** **Risk of scalding!**

Washing water is hot when washing at high temperatures. If you come into contact with the hot detergent solution, you may be scalded. Allow the detergent solution to cool down.

1. Turn off the water tap so that no more water can flow in and has to be drained via the detergent solution pump.
2. Switch off the appliance and pull out the mains plug.
3. Open and remove the service flap.
4. Fold out the water gutter in front of the pump cover.

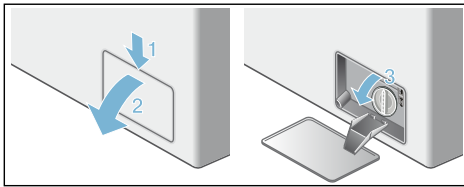

5.
  - Remove the **drainage hose** from its holder and remove the sealing cap. Allow the detergent solution to flow out into a suitable container. Replace the sealing cap on the drainage hose and place the drainage hose back in the retainer.

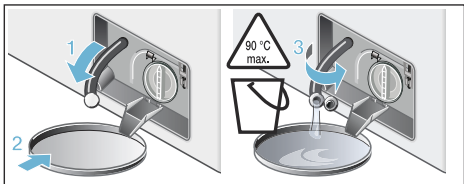

- **Without the drainage hose**  
Carefully turn the pump cover once through 180°, but do not remove it. The water now runs out of the detergent solution pump. Repeat the process until no more detergent solution flows out.



6. Now carefully unscrew the pump cover. Residual water may run out. Clean the interior, pump cover thread and pump housing. The impeller in the detergent solution pump must be able to rotate. Refit the pump cover and screw it on tightly. The handle should be vertical.

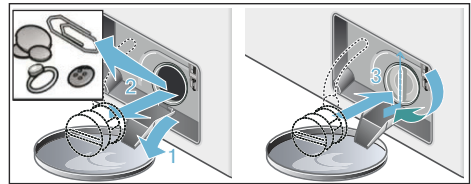

7. Fold in the water gutter.
8. Place the service flap back on, lock it into place, and close it.

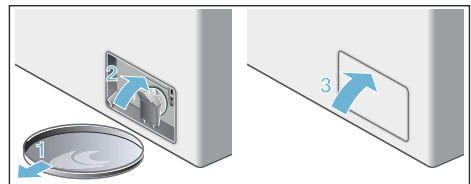

**Note:** To prevent unused detergent from flowing straight into the drain during the next wash: Pour 2 litre of water into compartment II and start the Empty programme.

## The drain hose at the siphon is blocked

1. Switch off the appliance. Disconnect the mains plug.
2. Loosen the hose clamp. Carefully remove the drain hose, residual water may leak out.
3. Clean the drainage hose and siphon connecting piece.

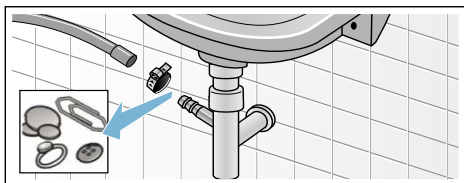

4. Reattach the drainage hose and secure the connection using the hose clamp.

## Filter in the water supply blocked

For this, first reduce the water pressure in the supply hose:

1. Turn off the tap.
2. Select any programme (except Rinse, Spin, Empty).
3. Press the Start button. Allow the programme to run for approximately 40 seconds.
4. Set the programme selector to the Off position. Remove the mains plug.
5. Clean the filter on the water tap: Remove the hose from the water tap. Clean the filter with a small brush.

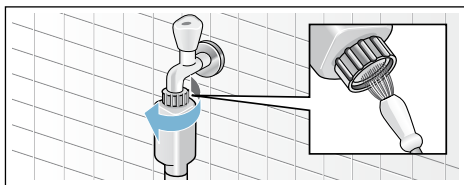

6. For standard and Aqua-Secure models, clean the filter on the rear of the appliance: Remove the hose from the rear of the appliance, Remove the filter using pliers and clean the filter.

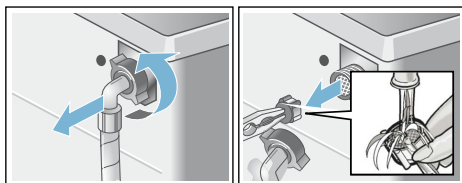

7. Connect the hose and check for leaks.

## ? Faults and what to do about them.

### Emergency release

E.g. in the event of a power cut

The programme continues running when the power supply is restored. However, if the laundry has to be removed, the washing machine door can be opened as follows:

#### **Warning** **Risk of scalding!**

When you are washing at high temperatures, there is a risk of scalding if you come into contact with hot detergent solution and laundry. If possible, leave it to cool down.

#### **Warning** **Risk of injury!**

You may injure your hands if you reach into the drum while it is rotating. Do not reach into the drum while it is rotating. Wait until the drum has stopped rotating.

**en** Faults and what to do about them.

### Caution!

#### Water damage

Any escaping water may cause water damage.

Do not open the washing machine door if water can be seen through the glass.

1. Set the programme selector to the Off position. Remove the mains plug.

2. Drain the water.  
Pull the emergency release downwards with a tool and release.

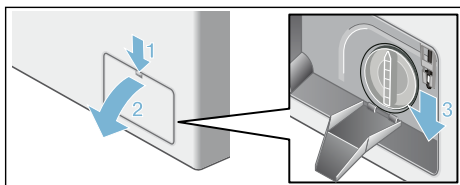

The washing machine door can then be opened.

## Information on the display panel

Display	Cause/remedial action
<b>YES</b>	The washing machine door is unlocked. It is possible to add laundry.
<b>NO</b>	<ul style="list-style-type: none"><li>■ Due to the high temperature in the drum, the washing machine door cannot be opened. Wait until the temperature drops.</li><li>■ Due to the high level of water in the drum, the washing machine door cannot be opened. Drain the water (e.g. select the Spin or Empty programme (if only a drain cycle is required, set rpm (spin speed) to  without final spin selected).</li></ul>
E:16	Laundry may become trapped. Close the washing machine door properly.
E:17	<ul style="list-style-type: none"><li>■ Turn on the cold water tap fully</li></ul>
E:29	<ul style="list-style-type: none"><li>■ Supply hose kinked or trapped</li><li>■ Water pressure too low. Clean the filter in ?</li></ul>
A: 10	<ul style="list-style-type: none"><li>■ Turn on the hot water tap fully, supply hose kinked or trapped.</li><li>■ Supply hose kinked/trapped; water pressure too low. Clean the filter.</li><li>■ Hot water hose not connected; washing machine is operated using cold water only. Ignore the message; this message is only displayed for the first wash cycle.</li></ul>
E:18	<ul style="list-style-type: none"><li>■ Detergent solution pump blocked. Clean the detergent solution pump.</li><li>■ Drain hose/waste pipe blocked. Clean the drain hose on the siphon.</li></ul>
E:23	Water in the base trough due to appliance leaking. Call after-sales service.
	If childproof lock is active, deactivate it.
Other displays	Switch off the appliance, wait for five seconds and switch it back on again. If the display appears again, call after-sales service.

## Faults and what to do about them.

Faults	Cause/remedy
Water is leaking from the appliance.	<ul style="list-style-type: none"> <li>■ Attach the drain hose correctly or replace it.</li> <li>■ Tighten the threaded joint on the inlet hose.</li> </ul>
The appliance is not filling with water.	<ul style="list-style-type: none"> <li>■ Start button not selected?</li> <li>■ Is the tap turned on?</li> </ul>
Detergent is not being dispensed.	<ul style="list-style-type: none"> <li>■ Could the filter be clogged? Clean the filter → Page 21.</li> <li>■ Is the inlet hose kinked or trapped?</li> </ul>
The door cannot be opened.	<ul style="list-style-type: none"> <li>■ The safety function is activated. Stop the programme?</li> <li>■ ☐ Rinse stop = ⌀ without final rinse selected? → Page 11.</li> <li>■ Can the door only be opened by the emergency release? → Page 21.</li> </ul>
The programme does not start.	<ul style="list-style-type: none"> <li>■ Start button for a pause or "Ready in" time pressed?</li> <li>■ Is the door closed?</li> <li>■ Childproof lock active? Deactivate.</li> </ul>
The water is not draining.	<ul style="list-style-type: none"> <li>■ ☐ Rinse stop = ⌀ without final rinse selected? → Page 11.</li> <li>■ Clean the drain pump. → Page 20.</li> <li>■ Clean the drain pipe and/or the drain hose.</li> </ul>
Water is not visible in the drum.	Not a fault - the water is below the visible area.
The spin result is not satisfactory. Laundry is wet/too damp.	<ul style="list-style-type: none"> <li>■ Not a fault – the unbalanced load detection system has interrupted the spin because the laundry is unevenly distributed. Distribute small and large items of laundry evenly in the drum.</li> <li>■ Is the selected speed too low?</li> </ul>
The spin cycle runs several times.	Not a fault – the unbalanced load detection system is adjusting an imbalance.
The programme takes longer than usual.	<ul style="list-style-type: none"> <li>■ Not a fault – unbalanced load detection system adjusts imbalance by repeatedly distributing the washing.</li> <li>■ Not a fault – foam detection system active – a rinse cycle is activated.</li> </ul>
The programme length changes during the wash cycle.	Not a fault - the programme sequence is optimised for the particular wash process. This may result in changes to the programme length in the display field.
Residual water in the care product dispenser.	<ul style="list-style-type: none"> <li>■ Not a fault - the effectiveness of the care product is not affected.</li> <li>■ Clean the insert if necessary.</li> </ul>
Odours in the washing machine.	Run the Cottons 90 °C programme without laundry. Use standard detergent for this.
☐ symbol flashes. Foam may be leaking from the detergent drawer.	<p>Have you used too much detergent?</p> <p>Mix one tablespoonful of fabric softener with ½ litre water and pour into dispenser II (Not for outdoor fabrics, sportswear fabrics or those made with down.)</p> <p>Use less detergent in the next washing cycle.</p>

Faults	Cause/remedy
Loud noises, vibrations and machine "movement" during the spin cycle.	<ul style="list-style-type: none"> <li>■ Is the appliance aligned? Align the appliance. → <i>Page 25.</i></li> <li>■ Are the appliance's feet secured? Secure the appliance's feet. → <i>Page 25.</i></li> <li>■ Have the transport braces been removed? Remove the transport braces. → <i>Page 27.</i></li> </ul>
The display panel/indicator lights do not work while the appliance is running.	<ul style="list-style-type: none"> <li>■ Has there been a power failure?</li> <li>■ Have the fuses blown? Reset/replace the fuses.</li> <li>■ If the fault occurs repeatedly, call the after-sales service. → <i>Page 24.</i></li> </ul>
There is detergent residue on the laundry.	<ul style="list-style-type: none"> <li>■ Some phosphate-free detergents contain water-insoluble residue.</li> <li>■ Select the rinse programme or brush the laundry after washing.</li> </ul>
<b>NO</b> appears in the display panel in Pause mode.	The water level is too high. It is not possible to add laundry. Close the washing machine door immediately, if necessary. Press the "Start" button to continue the programme.
<b>YES</b> appears in the display panel in Pause mode.	The door is unlocked. It is possible to add laundry.
<p>If you cannot correct a fault yourself (after switching on/off) or a repair is required:</p> <ul style="list-style-type: none"> <li>■ Set the programme selector to the "Off" position. The appliance is switched off.</li> <li>■ Unplug the mains plug from the socket.</li> <li>■ Turn off the tap and call the after-sales service. → <i>Page 24.</i></li> </ul>	

## After-sales service

If you cannot correct the fault yourself, (see section, Faults and what to do about them) → *Page 21*, please contact our after-sales service. → Cover page

We will always find an appropriate solution in order to avoid unnecessary visits by engineers.

Please give the after-sales service the product number (E no.) and the production number (FD) of the appliance.

You can find this information, \*depending on the model:

On the inside of the washing machine door\*/in the opened service flap\* and on the rear of the appliance.

### **Trust the expertise of the manufacturer.**

Contact us for assistance. By doing so, you will ensure that the repairs are carried out by trained service personnel using genuine spare parts.

E-Nr. _____	FD _____
Product number	Production number



## Technical data

### Dimensions:

60 x 55 x 85 cm  
(width x depth x height)

### Weight:

66 - 73 kg\*

### Mains connection:

Nominal voltage: 220-240 V, 50 Hz

Nominal current: 10 A / 13 A\*

Nominal power: 2300 W

### Water pressure:

100 - 1000 kPa (1-10 bar)

\* Depending on the model

### Power consumption when switched off:

0.17 W

### Power consumption when ready for use (left-on mode):

2.00 W

## Positioning and connecting

### Included with the appliance

**Note:** Check the machine for transport damage. Never use a damaged machine. If you have any complaints, contact the dealer from whom you purchased the appliance or our after-sales service.

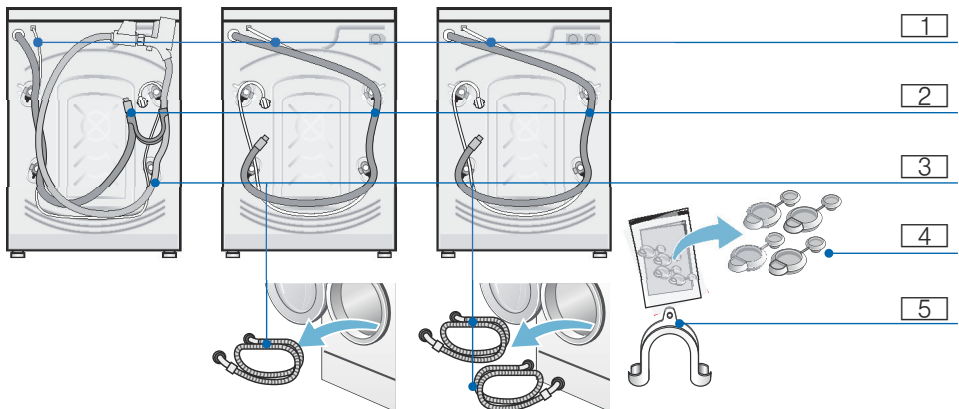

- 1 Mains cable
- 2 Water drainage
- 3 Water supply hose\*
- 4 Covers for the transport locks
- 5 Elbow for securing the water drain hose\*

\*depending on model

**In addition,** a hose clamp (24-40 mm diameter, available from specialist dealers) is required to connect the water drain hose to a siphon.

### Useful tools

- Spirit level for levelling
- Spanner with:
  - WAF 13 for loosening the transport locks, and
  - WAF 17 for aligning the appliance feet

## Safety instructions

### **Warning** **Risk of injury!**

- The washing machine is very heavy. Be careful when lifting/transporting the washing machine.
- When the washing machine is lifted by its protruding parts (e.g. the washing machine door), the components may break off and cause injuries. Do not lift the washing machine by protruding parts.
- If the hose and mains cables are not routed properly, there is a risk of tripping and injury. Lay hoses and cables in such a way that there is no risk of tripping.

### **Caution!**

#### **Damage to the appliance**

Frozen hoses may rip/burst. Do not install the washing machine in areas exposed to frost or outdoors.

### **Caution!**

#### **Water damage**

The connection points for the water supply hose and water drain hose are under high water pressure. To prevent leaks and water damage, you must follow the instructions in this section.

### **Notes**

- In addition to the safety information listed here, the local water and electricity supplier may have special requirements.
- If in doubt, have the appliance connected by a specialist.

## Installation surface

**Note:** The washing machine be stable so that it does not move around.

- The installation surface must be firm and level.
- Soft floors/floor coverings are not suitable.

## Installation on a base or a wooden joist floor

### **Caution!**

#### **Damage to the appliance**

The washing machine may wander and tip/topple from the base when spinning. Use holding brackets to secure the feet of the appliance.

Order no. WMZ 2200, WX 975600.

**Note:** On wooden joist floors, install the washing machine:

- In a corner, if possible,
- On a water-resistant wooden board (min. 30 mm thick) which is screwed tightly to the floor.

## Installation on a platform with drawer

Platform order no.: WMZ 20490, WZ 20490.

## Installing the appliance in a kitchenette

### **Warning** **Risk of death!**

There is a risk of electric shock if you touch live components. Disconnect the appliance from the power supply.

### **Notes**

- Recess width of 60 cm required.
- Only install the washing machine underneath a continuous worktop that is securely connected to adjacent cabinets.

If you remove the appliance covering plate for installation underneath the worktop or fitted in a cabinet, you must replace it with a metal cover.

Order no.: WMZ20331; WZ20331.

## Removing the transport locks

### Caution!

#### Damage to the appliance

- The machine is secured for transportation using transport locks. If the transport locks are not removed, the drum, for example, may become damaged when the machine is operated. Before using the appliance for the first time, make sure that you completely remove all four transport locks. Keep the locks in a safe place.
- To prevent transport damage from occurring if the appliance is moved at a later date, you must refit the transport locks before transporting the appliance.

**Note:** Keep the screws and sleeves in a safe place.

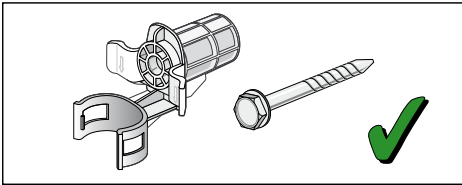

1. Take the hoses out of the holders.

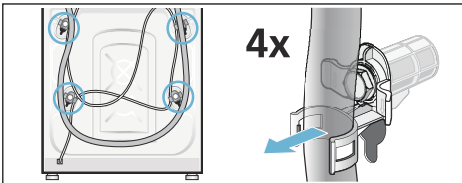

2. Unscrew and remove the bolts from all four transport safety devices. Remove the sleeves. To do this, remove the mains cable from the holders.

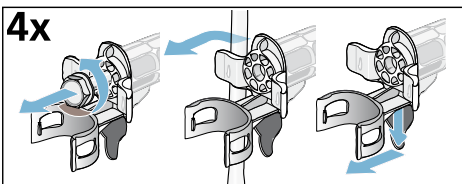

3. Insert the covers.

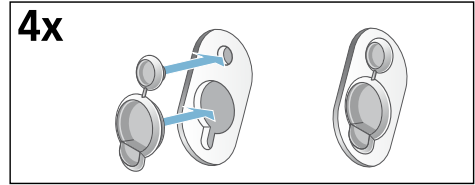

## Hose and cable lengths

- Left-hand connection

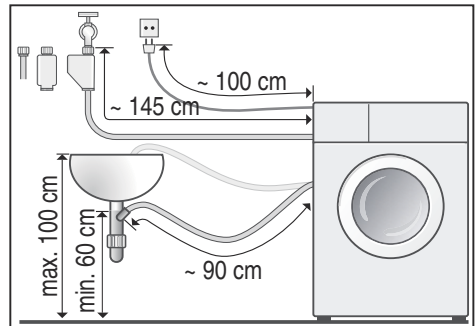

- Right-hand connection

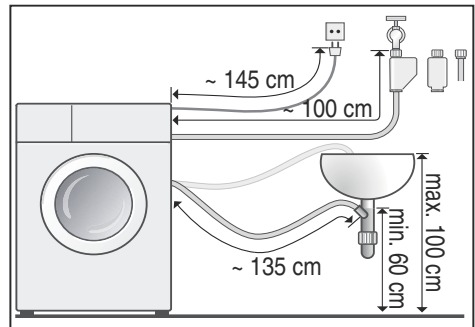

**Tip:** The following are available from specialist dealers/after-sales service:

- Extension for Aqua-Stop and cold water supply hose (approx. 2.50 m). Order no. WMZ2380, WZ10130.
- A longer supply hose (approx. 2.20 m) for standard model.

## Water inlet

### **Warning** **Risk of death!**

There is a risk of electric shock if you touch live components.

Do not immerse the Aqua-Stop safety valve in water (it contains an electric valve).

Observe the following when connecting the machine:

### Notes

- With a cold water connection, only operate the washing machine using cold mains water.
- With a hot water connection, operate the washing machine with hot and cold mains water, with a maximum temperature of 60 °C.
- Do not connect the machine to the mixer tap of an unpressurised hot-water boiler.
- Do not use a used supply hose. Only use the supply hose supplied or one that was purchased from an authorised specialist retailer.
- Do not bend, squash, modify or cut through the water supply hose (otherwise its strength is no longer guaranteed).
- Only tighten the screw connections by hand. If the screw connections are tightened too much with a tool (pliers), the thread may become damaged.

### Optimum water pressure in the supply network

**At least** 100 kPa (1 bar)

**Maximum** 1000 kPa (10 bar)

When the tap is open, the water flow is at least 8 l/min.

If the water pressure is higher than this, a pressure-reducing valve must be installed.

## Hot and cold water connection

### Note:

- Red hot water supply hose on the hot water tap and red valve on the appliance
- Cold water supply hose on the cold water tap and white valve on the appliance

Connection to the water pipes ( $\frac{3}{4}$ " = 26.4 mm)

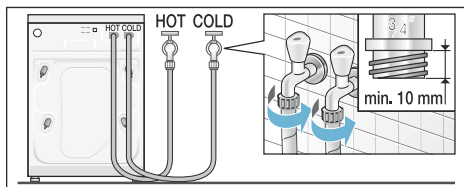

Connection to the appliance

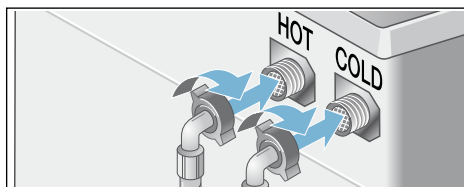

### Cold water connection only

If no hot water connection is present, only connect the cold water inlet hose and cover the hot water connection on the appliance so that it is kept free of dirt

**Note:** Carefully turn on the tap and check that the connection points are not leaking. The screw connection is under water pipe pressure.

## Cold water connection

Connect the water supply hose to the water tap ( $\frac{3}{4}$ " = 26.4 mm) and to the appliance (not necessary for Aqua-Stop models as this is permanently installed):

### ■ Model: **Standard**

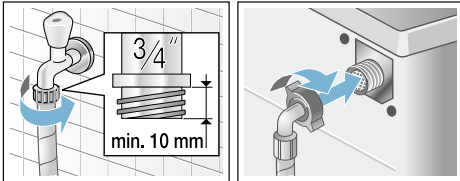

### ■ Model: **Aqua-Secure**

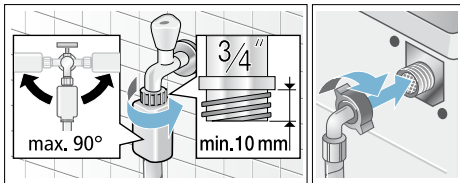

### ■ Model: **Aqua-Stop**

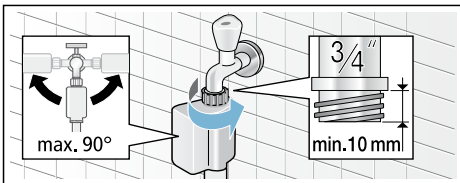

**Note:** Carefully turn on the tap and check that the connection points are not leaking. The screw connection is under water pipe pressure.

## Water outlet

### **Caution!** **Water damage**

If the drain hose slips out of the wash basin or the connection point during draining due to high water pressure, any escaping water may cause water damage. Secure the drain hose so that it cannot slip out.

**Note:** Do not kink the water drain hose or put strain on it lengthways.

You can lay the water drain hose as follows:

### ■ **Outlet in a sink**

#### **⚠ Warning** **Risk of scalding!**

When you are washing at high temperatures, there is a risk of scalding if you come into contact with hot detergent solution e.g. if hot detergent solution is being drained into a wash basin.

Do not reach into the hot detergent solution.

#### **Caution!**

#### **Damage to the appliance/fabrics**

If the end of the drain hose is immersed in the drained water, water may be sucked back into the appliance and may damage the appliance/fabrics.

Make sure that:

- The plug does not block drainage from the sink.
- The end of the drain hose is not immersed in the drained water.
- The water drains away quickly enough.

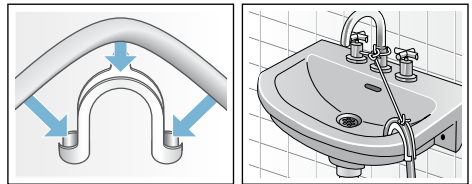

### ■ **Drainage into a siphon**

The connection point must be secured using a hose clamp with a diameter of 24-40 mm (available from specialist dealers).

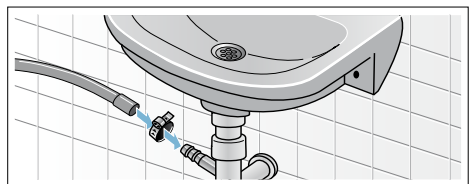

- **Outlet into a plastic pipe with rubber bushing or into a drainage pit**

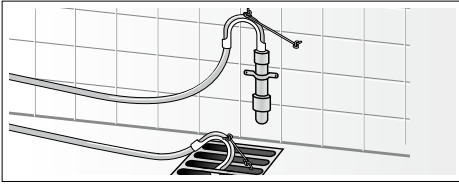

## Levelling

Level the appliance using a spirit level. Incorrect levelling may result in intense noise, vibrations and "wandering".

1. Loosen the lock nuts using a wrench, by turning it in a clockwise direction.
2. Check the alignment of the washing machine with a spirit level, and adjust it if necessary. Change the height by turning the appliance feet. All four appliance feet must stand firmly on the ground.
3. Tighten the lock nut against the housing.  
In doing so, hold the foot tight and do not adjust its height.  
The lock nuts on all four appliance feet must be screwed tightly against the housing.

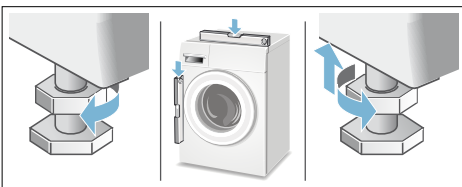

## Electrical connection

### **Warning** **Danger of death!**

There is a risk of electric shock if you touch live components.

- Never touch or hold the mains plug with wet hands.
- Only pull out the mains cable by the plug and never by the cable, as this could damage it.
- Never unplug the mains plug during operation.

Observe the following information and ensure that:

### Notes

- The mains voltage and voltage indicated on the washing machine (rating plate) are the same. The connected load and fuse required are specified on the rating plate.
- The washing machine is only connected to an alternating current via a properly installed earthed socket.
- The mains plug fits the socket.
- The cable cross-section is adequate.
- The earthing system is properly installed.
- The mains cable is only replaced by a qualified electrician (if this is necessary). Replacement mains cables are available from the after-sales service.
- No multiple plugs/couplings or extension cables are used.
- If an earth-leakage circuit breaker is used, only a type which displays this symbol is used: . Only this symbol guarantees compliance with the currently applicable regulations.
- The mains plug can be accessed at all times.
- The mains cable is not bent, squashed, modified, cut through, or in contact with heat sources.

## Before washing for the first time

The washing machine was thoroughly tested before leaving the factory. In order to remove any water which may be left over from the test, run the first washing cycle **without** any laundry.

### Notes

- The washing machine **must be correctly installed and connected.** (from → *Page 25*).
- Never use a damaged machine. Inform your after-sales service.

1. Check the machine.
  2. Plug in the mains plug.
  3. Turn the tap on.
  4. Close the washing machine door (do not load any laundry).
  5. Select the Cottons programme and 90 °C as the temperature.
  6. Open the detergent drawer.
  7. Pour approx. 2 litre of water into compartment **II**.
  8. Pour standard detergent into compartment **II**.
- Note:** Prevent foaming by only using half of the amount of detergent recommended by the detergent manufacturer. Do not use detergent for wool or delicates.
9. Close the detergent drawer.
  10. Press the Start button.
  11. When the programme ends, switch off the appliance.

Your washing machine is now ready to use.

## Transportation

e.g. when moving home

### Preparatory work:

1. Turn off the water tap.
2. Reduce the water pressure in the supply hose.  
Maintenance – filter in the water supply → *Page 21*

3. Drain the remaining detergent solution.  
Maintenance – detergent solution pump blocked → *Page 20*
4. Disconnect the washing machine from the mains.
5. Remove the hoses.

### Installing the transport locks:

1. Remove the covers and keep in a safe place.  
If required, use a screwdriver.

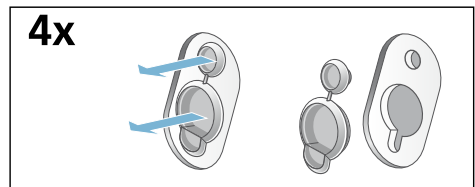

2. Insert all four sleeves. Clamp the mains cable on the holders. Insert and tighten the bolts.

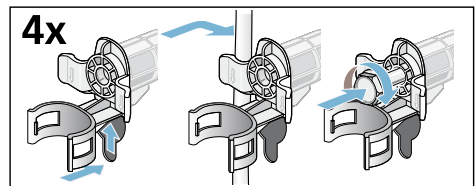

### Before commissioning:

#### Notes

- The transport locks **must** be removed.
- To prevent unused detergent from flowing straight into the drain during the next wash: Pour approx. 2 litre of water into compartment **II** and start the Empty programme.

## **Aqua-Stop warranty**

Only for appliances with Aqua-Stop

In addition to warranty claims against the vendor based on the purchase agreement and to our appliance warranty, we will provide compensation under the following conditions:

1. If water damage is caused due to a fault in our Aqua-Stop system, we will compensate domestic customers for the damage caused.
2. The liability guarantee is valid for the service life of the appliance.
3. It is a prerequisite of all warranty claims that the appliance with Aqua-Stop must have been installed and connected correctly in accordance with our instructions; this also includes a correctly fitted Aqua-Stop extension (genuine accessories).

Our warranty does not cover defective feed lines or fittings leading to the Aqua-Stop connection at the tap.

4. Appliances with Aqua-Stop do not need to be supervised during operation, nor secured afterwards by turning off the tap.  
The tap only needs to be turned off if you are away from home for a long period, e.g. for several weeks' holiday.



### **Advice and repair order in the event of faults**

GB 0344 892 8979 (Calls charged at local or mobile rate.)

IE 01450 2655 (0.03 € per minute at peak. Off peak 0.0088 € per minute.)

You can find the contact information for all countries in the attached after-sales service directory.

Robert Bosch Hausgeräte GmbH  
Carl-Wery-Straße 34  
81739 München, GERMANY



9000928967 (9504)