



Vax Ltd., Kingswood Road, Hampton Lovett, Droitwich, Worcestershire, WR9 0QH, UK
email: info@vax.co.uk - website: vax.co.uk



User Guide

Vax Careline: (UK) 0844 412 8455
(ROI) 1-800 928 308

Steam cleaner

steam

kitchen & bathroom master



Get cleaning...

What's your Vax model number? (Located on the flap of the packaging)

e.g. S5

What's your serial number? (Located on the base of the machine)

Note these down in case you need them in future. Please keep instructions for further use.

Machine Overview

- 1 Floor head parking slot
- 2 Water tank lid
- 3 Tool storage (hidden)
- 4 Carry handle
- 5 LED indicator
 - a) Water heating (orange LED)
 - b) Steam ready (orange LED) + (green LED)

- 6 On/off switch
- 7 Variable steam dial
- 8 Hose inlet
- 9 Extension tubes
- 10 Steam gun and hose
 - a) Extension tube release
 - b) Safety latch
 - c) Steam trigger

- 11 Measuring jug
- 12 Funnel
- 13 Floor head connector (dependant on model)

- 14 Concentration nozzle
- 15 Large plastic brush
- 16 Small plastic brush
- 17 Detail nozzle
- 18 Scraper tool
- 19 Grout brush
- 20 Window squeegee/upholstery tool
- 21 Floor head

- (dependant on model)
- 22 Floor head cloth (x1) (dependant on model)
- 23 Upholstery/clothes cloth (x2)
- 24 Triangular floor head (dependant on model)
- 25 Velcro microfibre pad (dependant on model)
- 26 Carpet glider (dependant on model)

Tool storage

NOTE: Items 15-19 are stored on both sides of the unit as shown below.

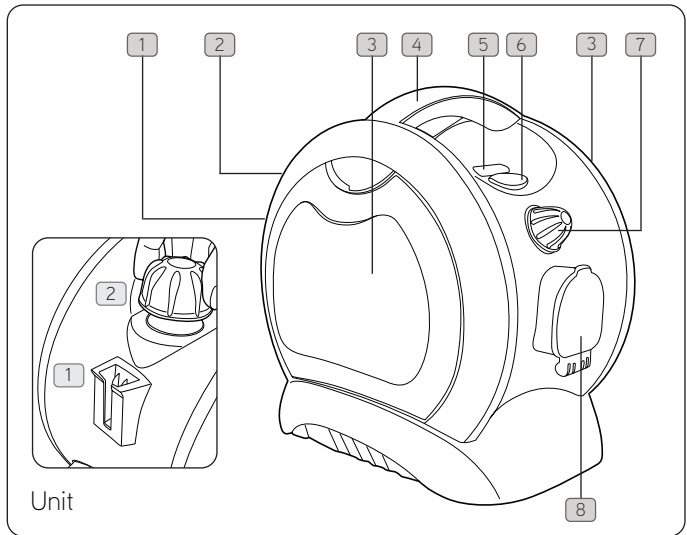
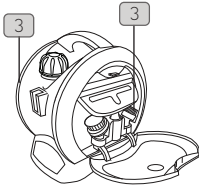

Accessories

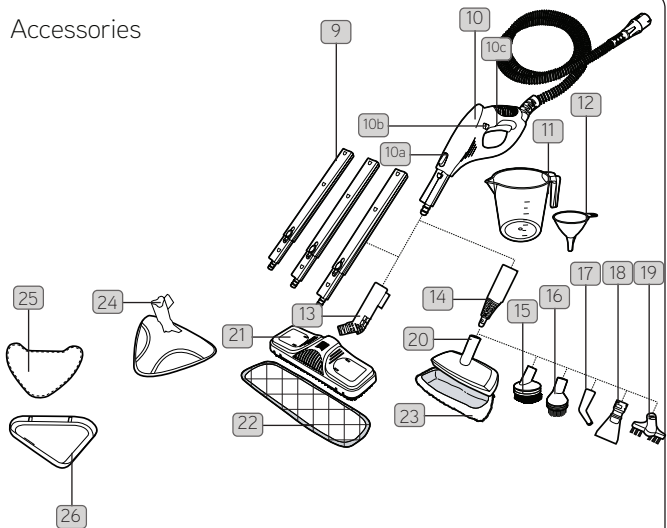

General Safety Information

FOR HOUSEHOLD USE ONLY.

When using the steam cleaner, basic safety precautions should always be observed, including the following:

IMPORTANT: Please refer to floor manufacturer's care recommendations before use and test the steam mop on a discrete area of flooring to begin with.



WARNING: The steam cleaner unit and accessories get very hot during operation.

DANGER OF SCALDING: Avoid contact with the steam.

1. Do not leave the steam cleaner unattended when plugged in. Unplug it from socket when not in use.
2. To prevent electric shock do not use outdoors.
3. Not to be used as a toy. Close supervision is necessary when used near children or the infirm.
4. This appliance can be used by children aged from 8 years and above and persons with reduced physical sensory or mental capabilities or lack of experience and knowledge if they have been given supervision or instruction concerning use of the appliance in a safe way and understand the hazards involved. Children shall not play with the appliance. Cleaning and user maintenance shall not be made by children without supervision.
5. Use only as described in this manual.
6. Do not use the steam cleaner if it has been dropped, damaged, left outdoors or dropped into water. Do not use the steam cleaner with a damaged cord or plug. If the supply cord is damaged, it must be replaced by the manufacturer or a recommended Service Agent to avoid hazard and invalidating the guarantee.
7. Do not pull or carry by the cord, use the cord as a handle, allow the cord to come into contact with hot or sharp surfaces or close a door on the cord.
8. Do not unplug by pulling on the cord.
9. Do not handle the plug or steam cleaner with wet hands.
10. Do not put any objects into openings or operate with openings blocked.
11. Do not use without the tank cap in place.
12. Turn off all controls before unplugging.
13. Keep the steam cleaner on the floor.
14. Do not use an extension cord.
15. Do not attempt to remove blockages with sharp objects as they may cause damage.
16. Store indoors, put away after use to prevent tripping accidents.
17. Using improper voltage may result in damage to the steam cleaner and possible injury to the user. The correct voltage is listed on the rating label.
18. A hazard may occur if the steam cleaner runs over the power supply cord.
19. The steam cleaner must be kept level during operation.
20. Never immerse the steam cleaner in water or other liquids.
21. Keep the steam cleaner away from rain and moisture. The steam cleaner is not suitable for outdoor use.
22. Do not operate the steam cleaner without water in the tank. Always top up with water in good time.
23. Empty the water tank when the steamer is not in use.
24. Never fill the tank with anything other than water. Never put additives (such as perfume, stain remover or products containing alcohol) in the water as they may damage the steam cleaner or make it dangerous to use.
25. Always remove the mains plug from the socket and allow this steam cleaner to cool down completely before topping up with water.
26. Do not overfill the tank. Do not exceed the maximum prescribed filling level. Please use the measuring jug and funnel included.
27. Ensure that the water tank cap has been screwed down fully before use.
28. Only carry the steam cleaner by the carry handle.
29. Do not touch any hot areas on the steam cleaner. It is normal for the steam cleaner to heat up during operation.
30. Do not use the steam cleaner to treat any items of clothing that are still being worn on the body.
31. The force and heat of the steam may have an adverse effect on some materials. Always check whether a surface is suitable for treatment with the steam cleaner by carrying out a test beforehand on a concealed area.
32. Always include these operating instructions if passing the steam cleaner on to a third party.
33. Never aim the steam cleaner at people, animals or plants (risk of scalding)! Do not aim the steam cleaner at electrical systems or wires.
34. Please always switch the appliance off and remove the mains plug from the socket if leaving the work area.
35. The steam cleaner is fitted with a thermostat and a thermal cut-out as protection against overheating.
36. Accessories become hot during use - allow them to cool down before handling.
37. Please ensure all parts are correctly fitted before using the product.
38. Do not use steamer on leather, wax polished furniture or floors, synthetic fabrics, velvet or other steam and water sensitive materials.
39. Do not use your steam cleaner if damaged/faulty. Please call our Vax Careline on 0844 412 8455.

NOTE: The liquid or steam must not be directed towards equipment containing electrical components, such as the interior of ovens.

This steamer is for household use only and NOT for commercial or industrial use.

PLEASE KEEP INSTRUCTIONS FOR FURTHER USE.

Operation

Operating your steam cleaner

IMPORTANT: Do not attach/remove accessories while steamer is in use (Hot water may drip out of the accessory - risk of scalding).

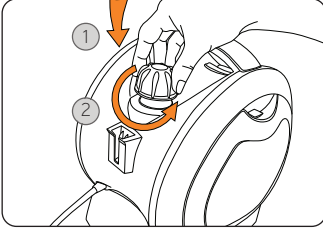

To remove lid push down and twist anti-clockwise.

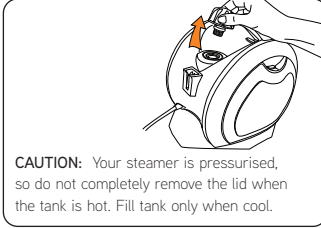

CAUTION: Your steamer is pressurised, so do not completely remove the lid when the tank is hot. Fill tank only when cool.



Use a measuring jug.

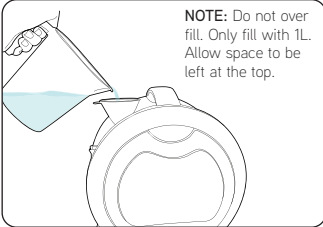

NOTE: Do not over fill. Only fill with 1L. Allow space to be left at the top.

Insert the funnel into the water tank to make filling the tank easier.

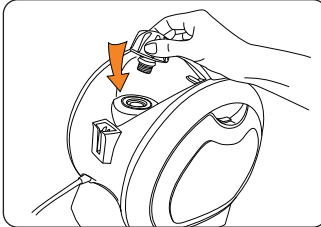

Ensure lid is securely fastened by pushing down and twisting.

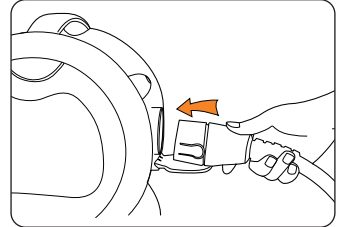

Attach hose to unit.

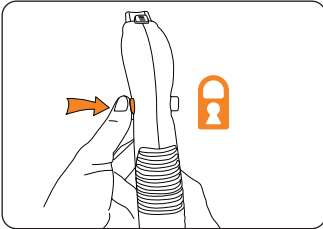

Ensure steam handle safety latch is on before heating.

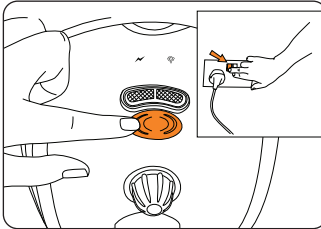

Turn steam cleaner on.

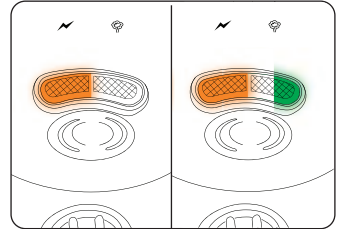

Orange LED - water heating
Orange LED + Green LED - steam ready (after 8 minutes)

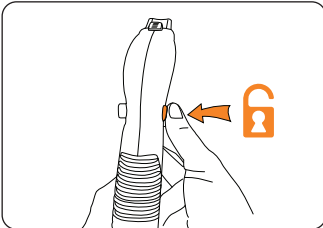

Release steam handle safety latch.

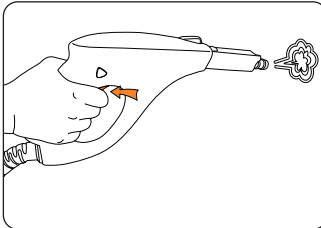

Press steam trigger to release steam.

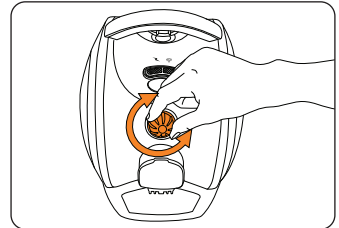

Rotate variable steam dial to adjust steam pressure.

Operation

Accessories

IMPORTANT: Do not attach/remove accessories while steamer is in use (Hot water may drip out of the accessory - risk of scalding).

IMPORTANT: Please refer to floor manufacturer's care recommendations before use and test the steamer on a discrete area of flooring to begin with.

Extension tubes

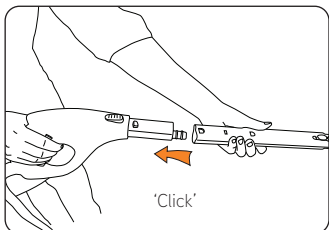

Attach extension tube to handle.

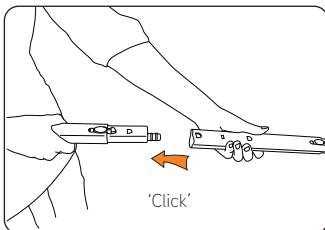

Attach extension tubes together.

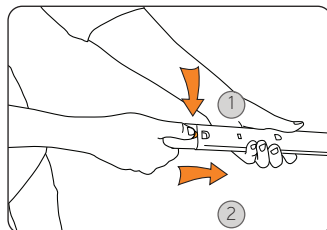

To remove/release tubes, press latch as shown.

Floor head (dependant on model)

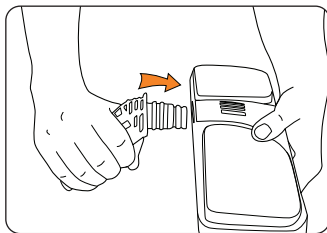

Attach the floor head connector to the floor head.

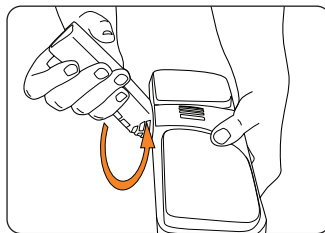

Rotate floor head connector into place.

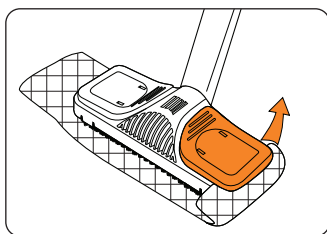
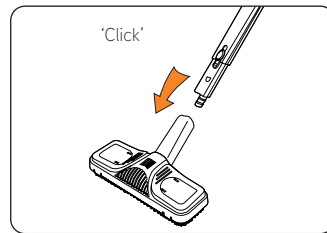

Lift levers on either side of the floor head to secure floor cloth.

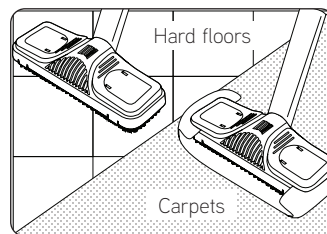
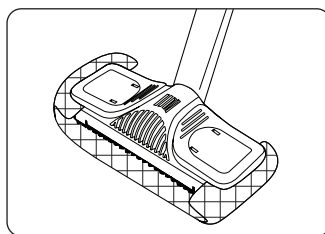

Operation

Floor head (dependant on model)

IMPORTANT: Please refer to floor manufacturer's care recommendations before use and test the steamer on a discrete area of flooring to begin with.

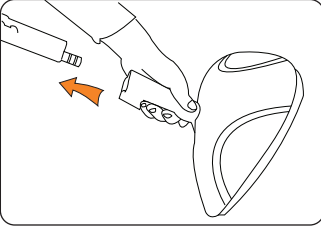

Attach extension tube to triangular floor head.

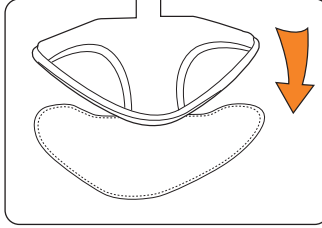

Place the product on top of the velcro microfibre pad. The blue face should be in contact with the floor.

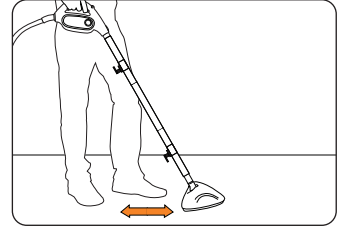

When cleaning hard floors, move the steamer slowly backwards and forwards paying particular attention to high traffic areas. Squeeze/release trigger as required.

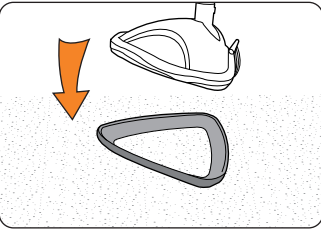

Place floor head (with velcro microfibre pad attached) into carpet glider.

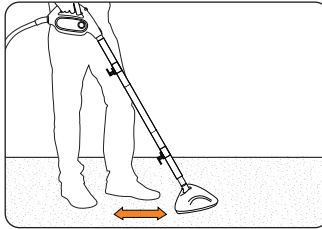

Move the steamer slowly backwards and forwards paying particular attention to high traffic areas.

Attaching small tools

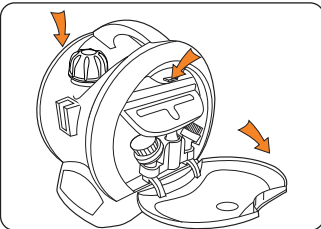

Access to built in accessories:

The steamer is fitted with a series of built-in accessories stored on both sides of the unit's main body. To access, squeeze tab at top of door to open.

Attaching accessories:

- 1 Push small tools onto concentration nozzle, aligning arrows.
- 2 Twist clockwise to fit.

NOTE: Concentration nozzle must be attached to the gun before fitting the tools.

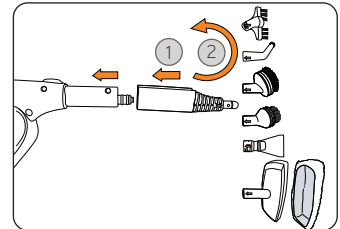

Maintenance (Keep your Vax as good as new)

Accessories

Using the small tools

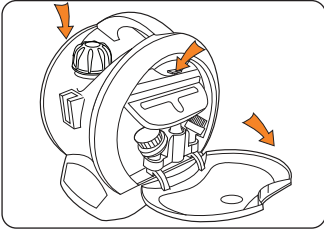

The steamer is fitted with a series of built-in accessories stored in the unit's main body. To access, squeeze tab at top of door to open.

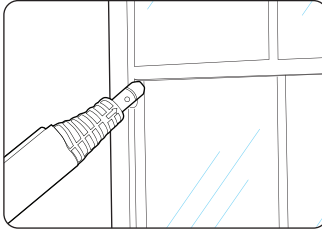

Concentration nozzle
Use to remove soap scum in baths and shower enclosures and to clean heavily soiled areas in kitchens.

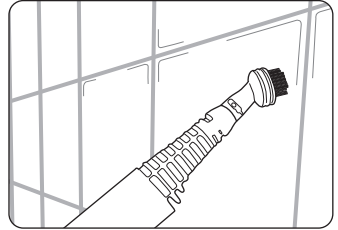

Brushes
Ideal for any surface from tiles, sinks, toilets and over taps.

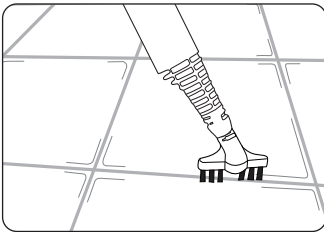

Grout brush
Lifts embedded dirt from inbetween tiles.

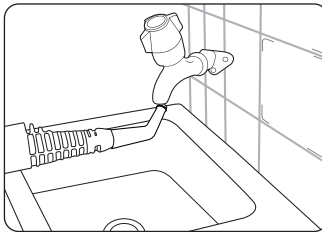

Detail tool
For hard to reach areas e.g. around taps.

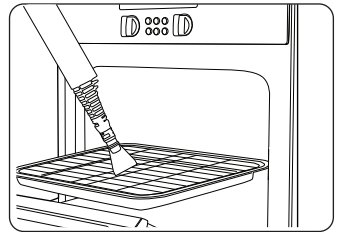

Scraper tool
Ideal for removing dried on residue from in ovens, work surfaces and pans.



Window squeegee tool
Great for leaving your windows, tiles and mirrors gleaming.

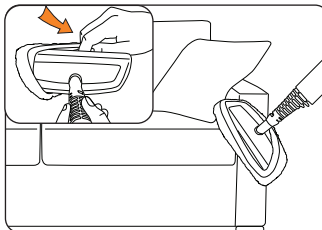

Upholstery/clothes tool
Attach the cloth to the squeegee tool for use on upholstery and clothes.

IMPORTANT: Test for colour fastness in a small hidden area of upholstery/fabric to check for colour removal before use.

FAQs

Cleaning cloths

IMPORTANT: Never use bleach or fabric softener when washing cloths.

- ① Wash by hand or machine washable at a 'warm' (max 40° c) temperature. Always use a mild detergent.
- ② Allow to fully dry before next use.

Storage

IMPORTANT: Steam cleaner must have cooled down before storing.

IMPORTANT: To maintain your steam cleaner's performance, when storing your machine turn the unit off at the plug and hold steam trigger down to release remaining steam pressure. Ensure the water tank has been fully drained before storing.

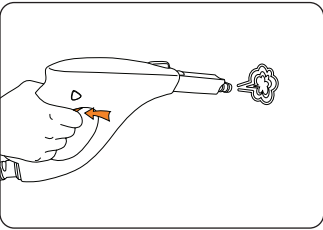

Press steam trigger to release steam.

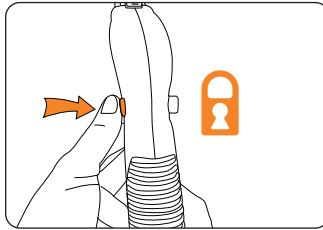

Ensure steam handle safety latch is on.

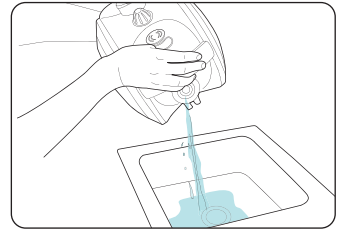

Empty unit of any remaining water.

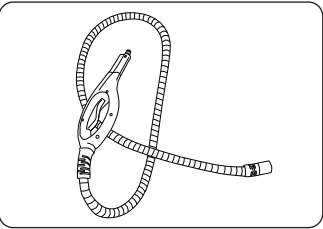

Hose can be hung up or loosely stored in the box.
Hose must not be tightly wound during storage.

Other Information

WARNING: to reduce the risk of personal injury, unplug the steamer and ensure the unit has fully cooled down before performing maintenance/troubleshooting checks.

Is there an accessory missing?

- Check the parts overview page in this guide to make sure the part is definitely included with your machine.
- If the part is missing, we're here to help. Simply call us on: **0844 412 8455**

What do I do if the machine/an accessory has become damaged or broken?

- Visit vax.co.uk for spares and parts.
- Please call our Careline to purchase new spares or order a replacement.

What do I do if the steam cleaner has no power?

- The unit may not be plugged into an electrical socket; ensure the plug is pushed in securely.
- Check the electrical socket is switched on.
- The electrical socket may not be working; check the fuse or breaker and consult an electrician.
- The power cord may be damaged; if it is it must be replaced by the manufacturer or a Vax authorised Service Agent.

Why is the steam cleaner not producing steam?

- Ensure that the mains power is switched on and the power button has been pressed on the unit.
- There may be no water in the tank; please refer to the operation section.
- Check that the safety latch has been unlocked on the steam handle.
- Check that the unit has not been overfilled as there must be space in the tank for the water to heat. If overfilled the unit will deliver little steam or water droplets.

- The water may not yet be at temperature; the green steam ready indicator light will illuminate when the water is at temperature and is ready to use.
- If the unit is producing a very small amount of steam, check the variable steam power dial and adjust to max.
- When the unit has been switched off and fully cooled, remove the water tank lid. If limescale build up can be seen inside the tank, the unit will need to be de-scaled.
- If none of the points above are of assistance, we're here to help. Simply call us on: **0844 412 8455**

What do I do if the steam cleaner takes a long time to heat up?

- When the unit has been switched off and fully cooled, remove the water tank lid. If limescale build up can be seen inside the tank, the unit will need to be de-scaled.
- Otherwise, we're here to help. Simply call us on: **0844 412 8455**

we're here to help

Instead of taking me back to the shop, simply call:

(UK) 0844 412 8455

(ROI) 1-800 928 308

vax.co.uk
vaxireland.ie

This does not affect your statutory rights

Other Information

UK Service & Help

Vax Careline:

(UK) 0844 412 8455

(ROI) 1-800 928 308

Monday-Friday 8.30am to 6.30pm

Saturday 9.00am to 5.00pm

Any queries or concerns about using your Vax, call the Vax Careline. Calls are charged at the UK local rate.

Please make a note of the serial number and model number of the steam cleaner before calling. For the nearest Service Agent, please call the Vax Careline or visit vax.co.uk

Consumables

To purchase spares and accessories, please visit vax.co.uk

Floor head cloth kit: 1-1-130745-00 (dependant on model)

Upholstery cloth kit: 1-9-130146-00

Velcro microfibre cleaning pads (Type 1): 1-1-131448-00 (dependant on model)

Coral cleaning pads (Type 1): 1-1-131643-00 (dependant on model)

Cleaning cloth (Type 1): 1-1-131643-00 (dependant on model)

Guarantee will only be valid with the use of genuine Vax spares and accessories.

Technical Specification

Wattage: 1500W

Voltage: 220 - 240V - 50Hz

Water tank capacity: 1.2L (useable capacity 1.0L)

Weight: 3.4kg

Cord length: 6m

Subject to technical change without notice.



EEC Statement of Compliance

Manufacturer/EEC importer: Vax Limited, hereby on our own responsibility, declare that the S5 series is manufactured in compliance with the following Directives:

Safety: 2006/95/EC Low Voltage Directive

EMC: 2004/108/EC Electromagnetic Compatibility Directive



Waste electrical products should not be disposed of with household waste. Please recycle where facilities exist. Check with your Local Authority or retailer for recycling advice.

