

Assembly Instructions

c: After the sitting test, re - tighten bolts again, if any adjustment needed.

c:

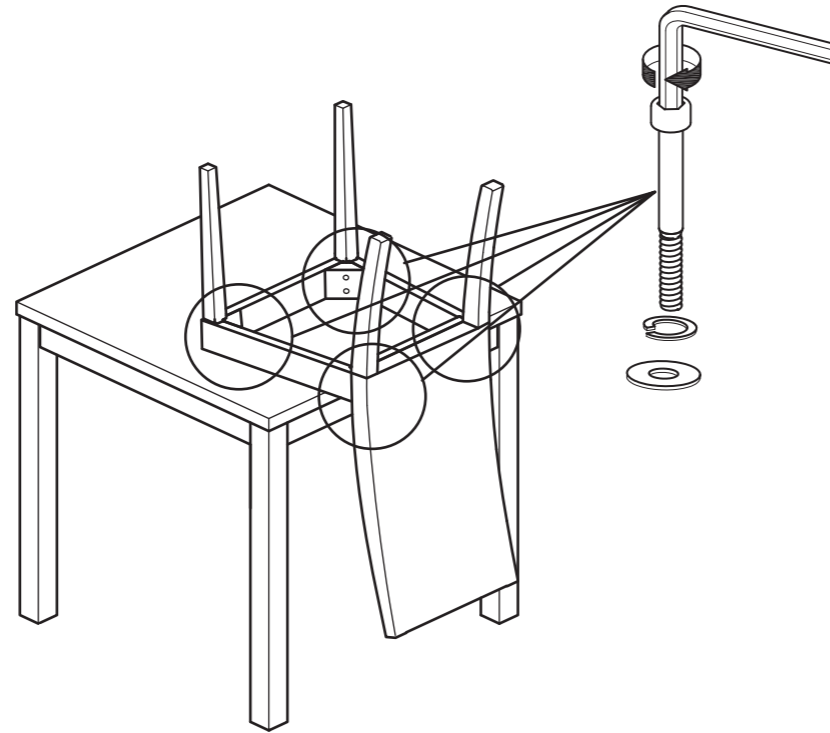

d: It is highly recommend to re - tighten all the bolts again after using the chair for 7 days.

d:

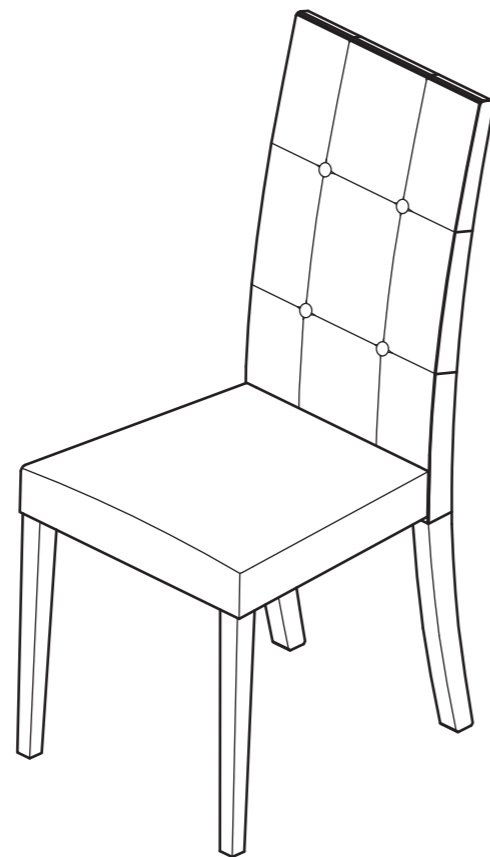

Note : Please keep the allen key to re - tighten all bolts again when required.

Assembly is complete.

If you need help or have damaged or missing parts, call the **Customer Helpline: 0345 640 0800**

Adaline Walnut Chair

Assembly Instructions - Please keep for future reference

244/2824

408/7524

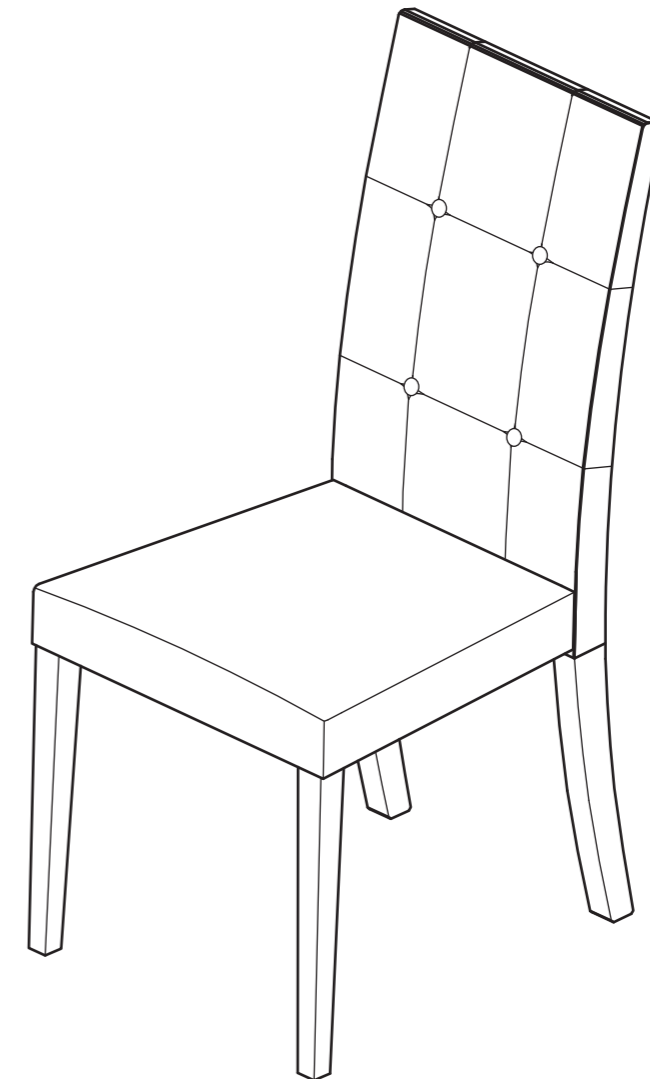

Dimensions

Width - 45cm
Depth - 56cm
Height - 93cm

Important – Please read these instructions fully before starting assembly

If you need help or have damaged or missing parts, call the **Customer Helpline: 0345 640 0800**

Safety and Care Advice

Important – Please read these instructions fully before starting assembly

- Check you have all the components and tools listed on page 2 and 3.

- Remove all fittings from the plastic bags and separate them into their groups.

- Keep children and animals away from the work area, small parts could choke if swallowed.

- Make sure you have enough space to layout the parts before starting.

- Do not stand or put weight on the product during assembly, this could cause damage.

- Assemble the item as close to its final position (in the same room) as possible.

- Assemble on a soft level surface to avoid damaging the unit or your floor.

- Parts of the assembly will be easier with 2 people.

- Do not stand on the chair.

- Do not use the chair as step ladder



- To reduce the likelihood of damaging your product please ensure that your

power drill is set on a low torque setting.

- Dispose of all packaging carefully and responsibly.

- Maximum safe weight of user: 110 Kgs.

Care and maintenance

- Only clean using a damp cloth and mild detergent, do not use bleach or abrasive cleaners.

- From time to time check that there are no loose screws on this unit.

- This product should not be discarded with household waste. Take to your local authority waste disposal centre.

Handy Hints

- Assemble all parts and bolts loosely during assembly, only once the product is complete should you fully tighten the bolts.

- Regularly check and ensure that all bolts and fittings are tightened properly.

Assembly Instructions

Step 2

Note : Stand the chair on a level floor.

a: Tightly screw all bolts.

Note : Step 2 is essential to prevent the chair from wobbling caused by uneven legs.

a:

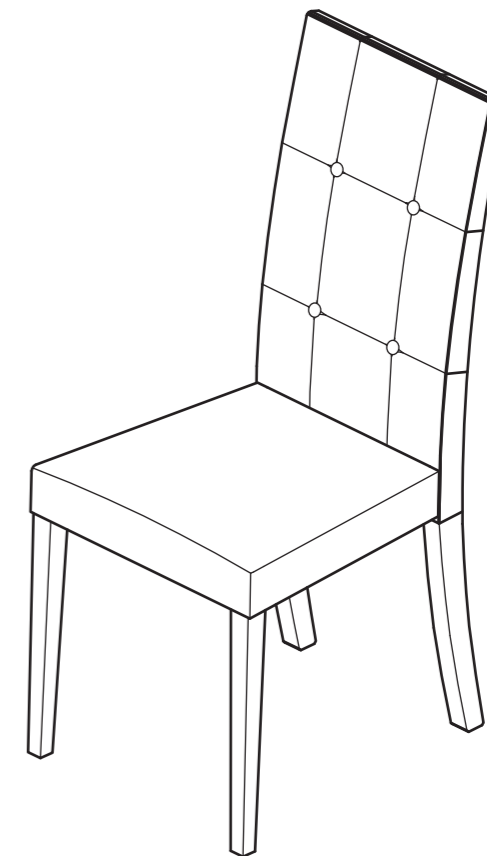

b: Sit on the chair to level the legs.

b:

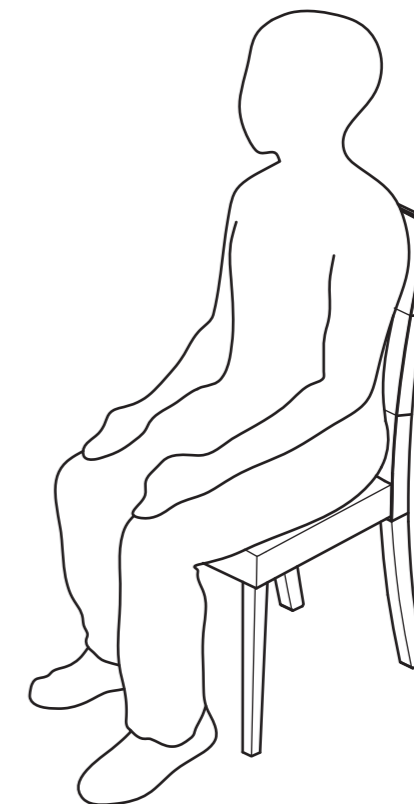

Assembly Instructions

C: Turn over the chair. Put legs **3** into front corners of the seat frame **2**. Insert bolts **A** with spring washers **B** and washers **C** into each of the 2 holes in the front corners. Tighten bolts with allen key **E**.

Do not fully tighten.

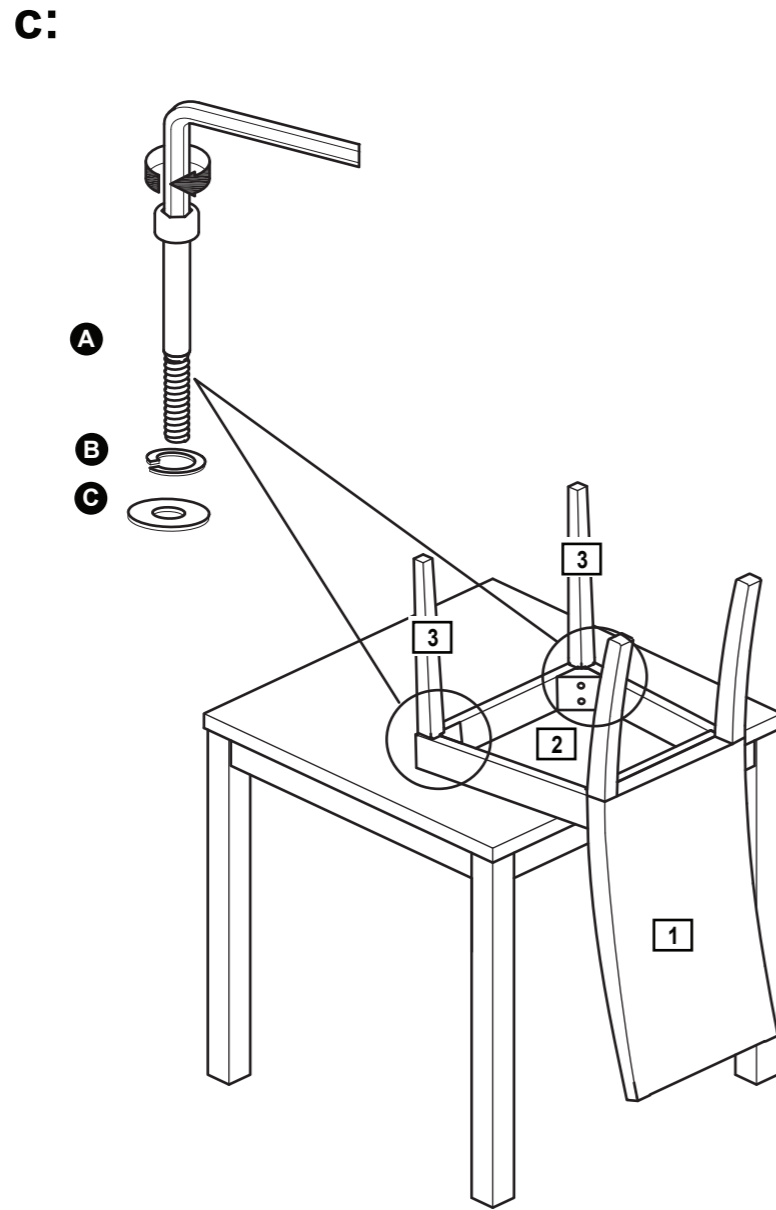

Components - Parts

If you have damaged or missing components, call the **Customer Helpline: 0345 640 0800**

Please check you have all the parts listed below

Note: The quantities below are the correct amount to complete the assembly of 1 chair.

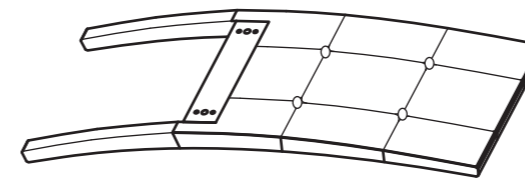

1 Chair back x 1

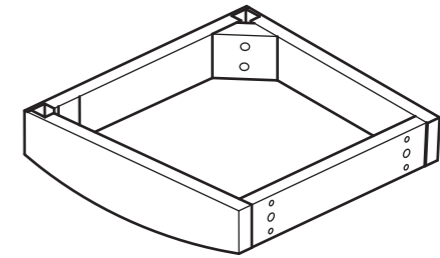

2 Seat x 1

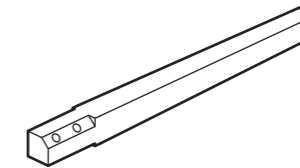





3 Leg x 2

Components - Fittings

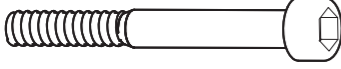
Please check you have all the fittings listed below

Note: The quantities below are the correct amount to complete the assembly of 1 chair. In some cases more fittings may be supplied than are required.

A  Bolt x 8	B  Spring washer x 8	C  Washer x 8
D  Wooden dowel x 2	E  Allen key x 1	

Assembly Instructions

Step 1

a: Insert wooden dowels **D** into each centre hole in the back of the seat **2**.

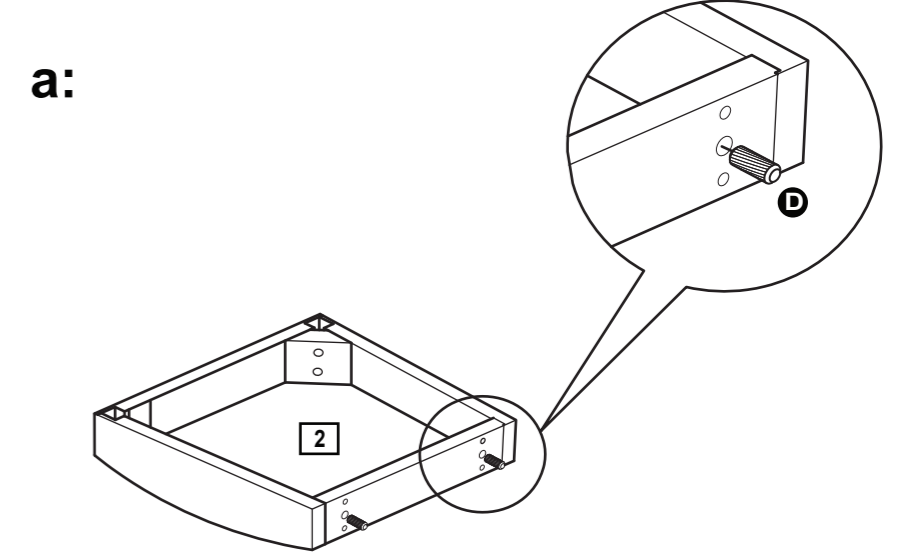

b: Insert bolts **A** with spring washers **B** and washers **C** through the holes at the back of the seat **2** into the chair back **1**. Tighten bolts with allen key **E**.

Do not fully tighten.

