

SONY[®]

User guide

Xperia™ Z2 Tablet
SGP521

Contents

Getting started	7
About this User guide.....	7
Overview.....	7
Assembly.....	8
Starting your device for the first time.....	10
Why do I need a Google™ account?.....	10
Charging your device.....	11
Learning the basics	12
Using the touchscreen.....	12
Locking and unlocking the screen.....	13
Home screen.....	14
Application screen.....	15
Navigating applications.....	16
Small apps.....	16
Widgets.....	17
Shortcuts and folders.....	18
Background and themes.....	19
Battery and power management.....	19
Taking a screenshot.....	21
Recording your screen.....	21
Notifications.....	22
Icons in the status bar.....	24
Application overview.....	26
Downloading applications	28
Downloading applications from Google Play™.....	28
Downloading applications from other sources.....	28
Internet and networks	29
Browsing the web.....	29
Internet and MMS settings.....	29
Wi-Fi®.....	30
Sharing your mobile data connection.....	32
Tethering with Xperia Link™.....	33
Controlling data usage.....	34
Selecting mobile networks.....	35
Virtual private networks (VPNs).....	35
Synchronising data on your device	37
Synchronising with online accounts.....	37
Synchronising with Microsoft® Exchange ActiveSync®.....	37
Synchronising with Outlook® using a computer.....	38

Basic settings	39
Accessing settings.....	39
Sound, ringtone and volume	39
SIM card protection	41
Screen settings.....	42
Daydream.....	43
Screen lock.....	43
Unlocking your device automatically.....	44
Language settings.....	48
Date and time.....	48
X-Reality™ for mobile.....	49
Super-vivid mode.....	49
Enhancing the sound output.....	49
Noise cancellation.....	49
Multiple user accounts.....	50
Typing text	53
On-screen keyboard.....	53
Entering text using voice input.....	54
Editing text.....	54
Personalising the on-screen keyboard.....	55
Calling	57
Making calls.....	57
Receiving calls.....	58
Ongoing calls.....	60
Using the call log.....	60
Forwarding calls.....	61
Restricting calls.....	61
Multiple calls.....	62
Conference calls.....	62
Voicemail.....	63
Emergency calls.....	63
Contacts	64
Transferring contacts.....	64
Searching and viewing contacts.....	65
Adding and editing contacts.....	66
Favourites and groups.....	67
Sending contact information.....	67
Avoiding duplicate entries in the Contacts application.....	67
Backing up contacts.....	68
Messaging and chat	69
Reading and sending messages.....	69
Organising your messages.....	70

Calling from a message.....	71
Messaging settings.....	71
Instant messaging and video chat.....	71
Email.....	72
Setting up email.....	72
Sending and receiving email messages.....	72
Organising your email messages.....	73
Email account settings.....	74
Gmail™	74
Music	76
Transferring music to your device	76
Listening to music.....	76
Music home screen menu.....	77
Playlists.....	78
Sharing music.....	79
Enhancing the sound.....	79
Visualiser	80
Recognising music with TrackID™	80
FM radio.....	82
Listening to the radio.....	82
Favourite radio channels.....	83
Sound settings.....	83
Camera.....	84
Taking photos and recording videos.....	84
Face detection.....	85
Using Smile Shutter™ to capture smiling faces.....	85
Adding the geographical position to your photos.....	86
General camera settings.....	86
Still camera settings.....	90
Video camera settings.....	93
Photos and videos in Album.....	96
Viewing photos and videos.....	96
Sharing and managing photos and videos.....	97
Editing photos with the Photo editor application.....	98
Editing videos with the Movie Creator application.....	99
Hiding photos and videos.....	99
Album home screen menu.....	100
Viewing your photos on a map.....	101
Videos.....	103
Watching videos in the Video application.....	103
Transferring video content to your device	104
Managing video content.....	104

Movie Creator.....	104
Connectivity.....	106
Mirroring the screen of your device on a TV using a cable.....	106
Mirroring the screen of your device wirelessly.....	106
Sharing content with DLNA Certified™ devices.....	107
Connecting your device to USB accessories.....	109
Connecting your device to a DUALSHOCK™ series wireless controller.....	110
NFC.....	110
Bluetooth® wireless technology.....	112
One-touch setup.....	114
Smart apps and features that save you time.....	115
Controlling accessories and settings with Smart Connect™.....	115
Using your device as a fitness hub with ANT+™.....	117
Using your device as a wallet.....	117
Travel and maps.....	118
Using location services.....	118
Google Maps™ and navigation.....	118
Using data traffic when travelling.....	118
Using your device with a car infotainment system.....	119
Airplane mode.....	119
Calendar and alarm clock.....	121
Calendar.....	121
Alarm and clock.....	122
Accessibility.....	125
Magnification gestures.....	125
Large text.....	125
Colour correction.....	125
TalkBack.....	125
Support and maintenance.....	127
Support for your device.....	127
Computer tools.....	127
Updating your device.....	128
Finding a lost device.....	129
Finding the identification number of your device.....	130
Memory and storage.....	130
Managing files using a computer.....	132
Backing up and restoring content.....	133
Running diagnostic tests on your device.....	135
Resetting your applications.....	135
Restarting and resetting your device.....	136
Using your device in wet and dusty conditions.....	137

Recycling your device.....	138
Limitations to services and features.....	139
Legal information.....	139

Getting started

About this User guide

This is the **Xperia™ Z2 Tablet** User guide for the **Android™ 5.1** software version. If you're not sure which software version your device is running, you can check it via the Settings menu. For more information about software updates, see *Updating your device* on page 128 .

To check the current software version of your device

- 1 From your Home screen, tap .
- 2 Find and tap **Settings** > **About tablet** > **Android™ version**.

Overview

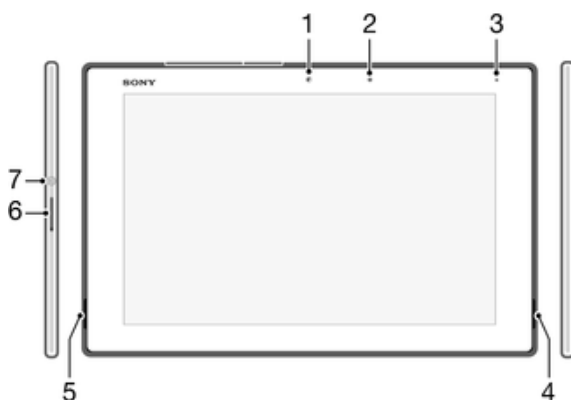

- 1 Front camera
- 2 Light sensor
- 3 Charging/Notification light
- 4 Speaker A
- 5 Speaker B
- 6 Volume/Zoom key
- 7 Power key

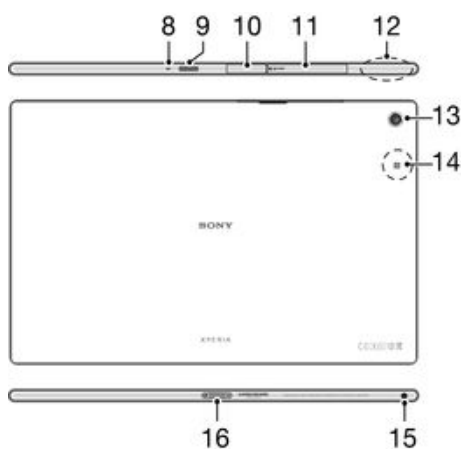

- 8 Microphone
- 9 Infrared sensor
- 10 Charger/USB port cover

11 Memory card/Micro SIM card slot cover

12 **Wi-Fi**/GPS/Bluetooth antenna area

13 Main camera

14 NFC™ detection area

15 Headset jack

16 Charging dock connector

Assembly

A protective plastic sheet is attached to the screen. You should peel off this sheet before using the touchscreen. Otherwise, the touchscreen might not function properly.

To insert the micro SIM card

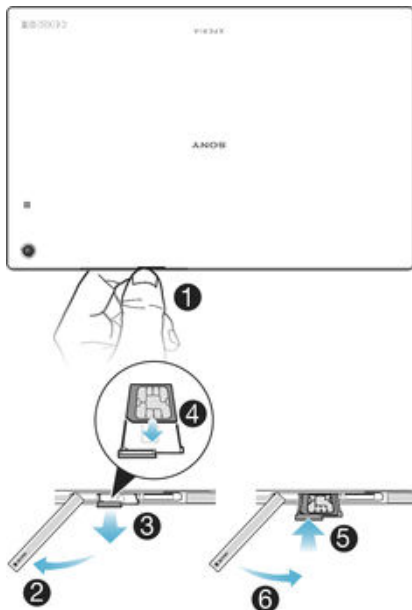

- 1 With the back of the device facing up (as in the illustration), insert a fingernail into the gap between the micro SIM card slot cover and the device, then detach the cover.
 - 2 Using a fingernail, pull out the micro SIM card holder.
 - 3 Place the micro SIM card in the holder, with the gold-coloured contacts on the micro SIM card facing up.
 - 4 Insert the micro SIM card holder back into the device.
 - 5 Re-attach the micro SIM card slot cover.
- ! Inserting the micro SIM card into the device without the micro SIM card holder could damage your micro SIM card or your device. Sony Mobile does not warrant and will not be responsible for any damage caused by such action.

To remove the micro SIM card

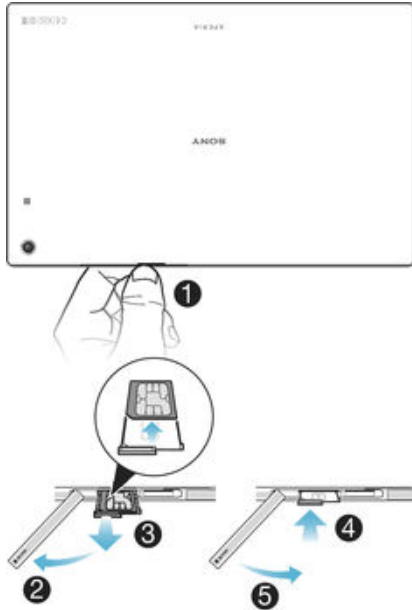

- 1 Remove the cover of the micro SIM card slot.
- 2 Pull out the micro SIM card holder.
- 3 Remove the micro SIM card.
- 4 Insert the micro SIM card holder back into its slot.
- 5 Re-attach the micro SIM card slot cover.

To insert a memory card

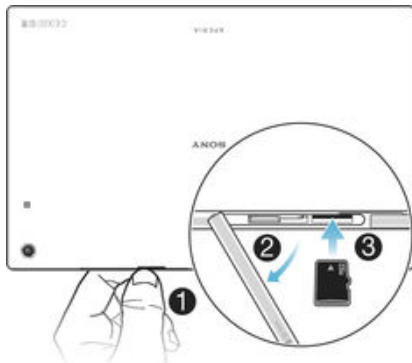

- 1 Insert a fingernail into the gap between the memory card slot cover and the top side of the device, then detach the cover.
- 2 Place the memory card in the memory card slot, with the gold-coloured contacts facing down, then push the memory card all the way into the slot until you hear a locking sound.
- 3 Reattach the memory card cover.

To remove the memory card

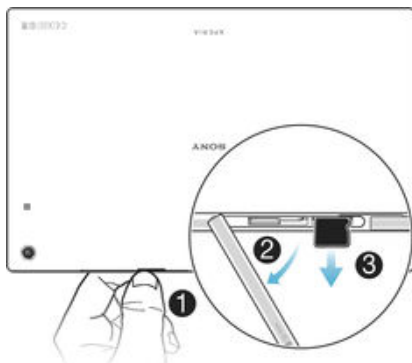

- 1 Turn off the device.
- 2 Remove the cover of the memory card slot, then press against the edge of the memory card and release it.
- 3 Draw the card outwards to remove it fully.

Starting your device for the first time



The first time you start your device, a setup guide opens to help you configure basic settings, sign in to some accounts and personalise your device. For example, if you have a Sony Entertainment Network or Google™ account, you can sign in to it here and get set up straight away.

- 💡 You can also access the setup guide later from the Settings menu. To access the setup guide on a device with multiple users, you must be logged in as the owner, that is, the primary user.

To turn on the device

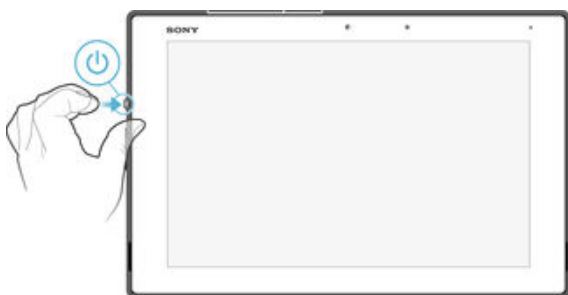
- ! Make sure that the battery is charged for at least 30 minutes before you turn on the device for the first time.



- 1 Press and hold down the power key  until the device vibrates.
- 2 Enter your SIM card PIN when requested, then tap .
- 3 Wait a while for the device to start.

- 💡 Your SIM card PIN is initially supplied by your network operator, but you can change it later from the Settings menu. To correct a mistake made while entering your SIM card PIN, tap .

To turn off the device

- 1 Press and hold down the power key  until the options menu opens.
- 2 In the options menu, tap **Power off**.

- ! It may take a while for the device to shut down.



Why do I need a Google™ account?

Your Xperia™ device from Sony runs on the Android™ platform developed by Google™. A range of Google™ applications and services is available on your device when you purchase it, for example, Gmail™, Google Maps™, YouTube™ and the Play Store™ application, which gives you access to the Google Play™ online store for downloading Android™ applications. To get the most out of these services, you need a Google™ account. For example, a Google™ account is mandatory if you want to:

- Download and install applications from Google Play™.
- Synchronise email, contacts and the calendar.
- Chat with friends using the Hangouts™ application.
- Synchronise your browsing history and bookmarks.

For more information about Android™ and Google™, go to www.sonymobile.com/support.

To set up a Google™ account on your device

- 1 From your Home screen, tap .
 - 2 Find and tap **Settings** > **Accounts** > **Add account** > **Google**.
 - 3 Follow the registration wizard to create a Google™ account, or sign in if you already have an account.
-  You can also sign in to or create a Google™ account from the setup guide the first time you start your device. Or you can go online and create an account at www.google.com/accounts.



Charging your device

Your device has an embedded, rechargeable battery that should be replaced only by Sony or an authorised Sony repair centre. You should never try to open or take apart this device yourself. Opening the device can cause damage that will void your warranty.

The battery is partly charged when the device is shipped from the factory. Depending on how long it was in the box before you purchased it, the battery level may be quite low. It is therefore recommended that you charge the battery for at least 30 minutes before starting up your device for the first time. You can still use your device while it is charging. Read more about how to improve the battery performance in *Battery and power management* on page 19 .

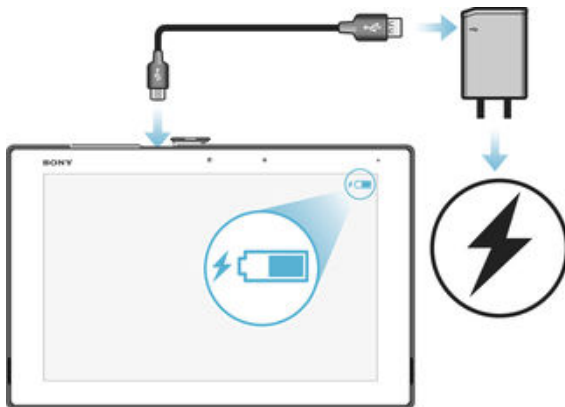
To charge your device



- 1 Plug the charger into a power outlet.
 - 2 Plug one end of the USB cable into the charger (or into the USB port of a computer).
 - 3 Plug the other end of the cable into the micro USB port on your device, with the USB symbol facing up. The notification light illuminates when charging begins.
 - 4 When the device is fully charged, disconnect the cable from your device by pulling it straight outwards. Make sure not to bend the connector.
-  If the battery is completely discharged, it may take a few minutes before the notification light illuminates and the charging icon  appears.

Battery notification light status

Green	The battery is charging and the battery charge level is greater than 90%
Red	The battery is charging and the battery charge level is less than 15%
Orange	The battery is charging and the battery charge level is less than 90%

Learning the basics

Using the touchscreen

Tapping



- Open or select an item.
- Mark or unmark a checkbox or option.
- Enter text using the on-screen keyboard.

Touching and holding

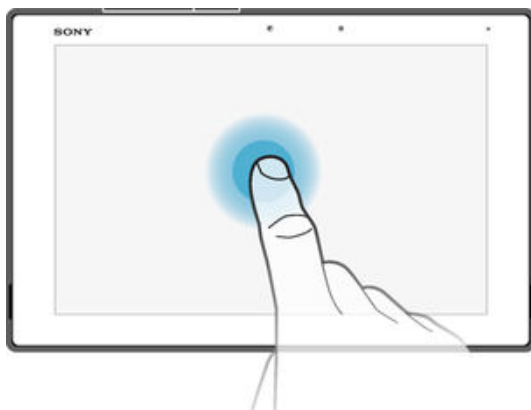

- Move an item.
- Activate an item-specific menu.
- Activate selection mode, for example, to select several items from a list.

Pinching and spreading

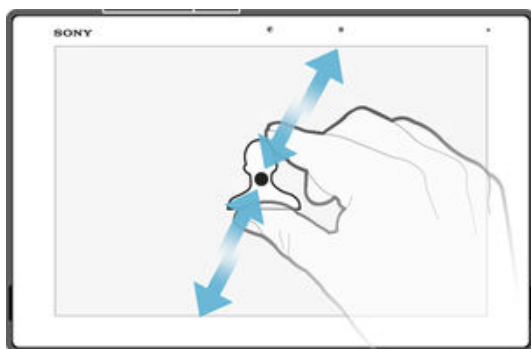

- Zoom in or out on web pages, photos and maps, and when you're taking photos or shooting videos.

Swiping

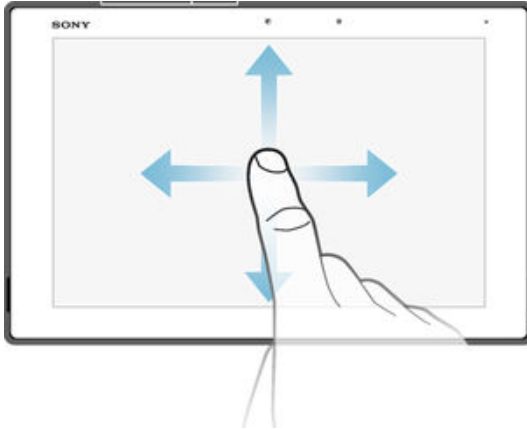

- Scroll up or down a list.
- Scroll left or right, for example, between Home screen panes.

Flicking

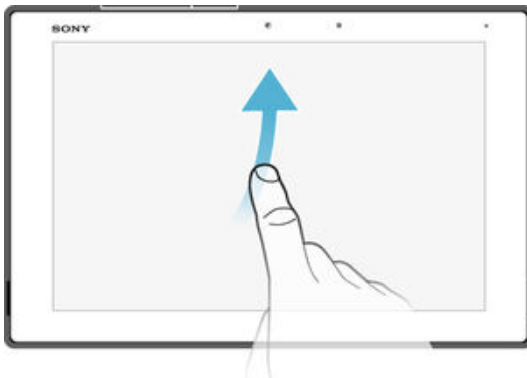

- Scroll quickly, for example, in a list or on a web page. You can stop the scrolling movement by tapping the screen.

Locking and unlocking the screen

When your device is on and left idle for a set period of time, the screen darkens to save battery power and locks automatically. This lock prevents unwanted actions on the touchscreen when you are not using it. When you buy your device, a basic screen swipe lock is already set. This means that you have to swipe upwards on the screen to unlock it. You can change the security settings later and add other kinds of locks. See *Screen lock* on page 43 .



To activate the screen

- Briefly press the power key .

To lock the screen

- When the screen is active, briefly press the power key .

Home screen

The Home screen is the starting point for using your device. It's similar to the desktop on a computer screen. Your Home screen can have up to seven panes, which extend beyond the regular screen display width. The number of Home screen panes is represented by a series of dots at the lower part of the Home screen. The highlighted dot shows the pane that you are currently in.



To go to the Home screen

- Press .

To browse the Home screen



Home screen panes

You can add new panes to your Home screen (up to a maximum of seven panes) and delete panes. You can also set the pane that you want to use as the main Home screen pane.

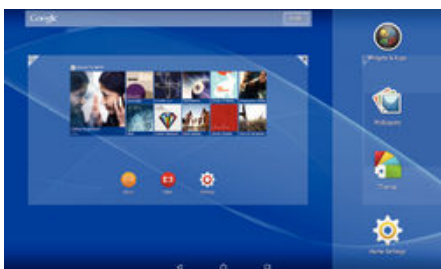

To set a pane as the main Home screen pane

- 1 Touch and hold an empty area on your Home screen.
- 2 Flick left or right to browse to the pane that you want to set as your main Home screen pane, then tap .

To add a pane to your Home screen

- 1 Touch and hold an empty area on your Home screen.
- 2 To browse the panes, flick all the way to the right or left, then tap .

To delete a pane from your Home screen

- 1 Touch and hold an empty area on your Home screen.
- 2 Flick left or right to browse to the pane that you want to delete, then tap .

Home screen settings

Use the **Home Settings** shortcut to adjust some basic settings on your Home screen. For example, you can set your Home screen to auto rotate and adjust the size of icons.

To set your Home screen to auto rotate

- 1 Touch and hold an empty area on your Home screen, then tap **Home Settings**.
- 2 Drag the slider beside **Auto rotation** to the right.

To adjust the size of icons on your Home screen

- 1 Touch and hold an empty area on your Home screen, then tap **Home Settings**.
- 2 Tap **Icon size**, then select an option.

Application screen

The Application screen, which you open from the Home screen, contains the applications that come pre-installed on your device as well as applications that you download.



To view all applications on the Application screen

- 1 From your Home screen, tap .
- 2 Flick left or right on the Application screen.

To open an application from the Application screen

- Flick left or right to find the application, and then tap the application.

To search for an application from the Application screen

- 1 When the Application screen is open, tap .
- 2 Enter the name of the application that you want to search for.

To open the Application screen menu

- When the Application screen is open, drag the left edge of the screen to the right.

To move an application on the Application screen

- 1 To open the Application screen menu, drag the left edge of the Application screen to the right.
- 2 Make sure that **Custom order** is selected under **SHOW APPS**.
- 3 On the Application screen, touch and hold the application until it becomes selected, then drag it to the new location.

To add an application shortcut to the Home screen

- 1 To open the Application screen menu, drag the left edge of the Application screen to the right.
- 2 Make sure that **Custom order** is selected under **SHOW APPS**.
- 3 On the Application screen, touch and hold an application icon, then drag the icon to the top of the screen. The Home screen opens.
- 4 Drag the icon to the desired location on the Home screen, then release your finger.

- 💡 If **Alphabetical** or **Most used** is selected under **SHOW APPS** instead of **Custom order**, you can still add an application shortcut to the Home screen. Just touch and hold the relevant application icon until the Home screen opens, then drag the icon to the desired location and release your finger.

To arrange applications on the Application screen

- 1 To open the Application screen menu, drag the left edge of the Application screen to the right.
- 2 Select the desired option under **SHOW APPS**.

To uninstall an application from the Application screen

- 1 To open the Application screen menu, drag the left edge of the Application screen to the right.
- 2 Tap **UNINSTALL**. All uninstalleable applications are indicated by .
- 3 Tap the application that you want to uninstall, then tap **OK**.

Navigating applications

You can navigate between applications using the navigation keys, the favourites bar, and the recently used applications window, which lets you switch easily between all recently used applications. The navigation keys are the Home key, the Recent apps key and the Back key. Some applications get closed when you press the Home key  to exit while others are paused or continue to run in the background. If an application is paused or running in the background, you can continue where you left off the next time you open the application.





- | | |
|---|--|
| 1 | Recently used applications window – Open a recently used application |
| 2 | Favourites bar – Use a shortcut to access applications or widgets |
| 3 | Recent apps key – Open the recently used applications window and the favourites bar |
| 4 | Home key – Exit an application and go back to the Home screen |
| 5 | Back key – Go back to the previous screen within an application or close the application |

To open the recently used applications window

- Press .

To close all the recently used applications

- Tap  and then tap .

To open a menu in an application

- While using the application, press .
- ! A menu is not available in all applications.

Small apps

Small apps are miniature apps that run on top of other applications on the same screen, to enable multi-tasking. For example, you can have a webpage open showing details of currency exchange rates and then open the Calculator small app on top of it and perform calculations. You can access your small apps via the favourites bar. To download more small apps, go to Google Play™.





To open a small app

- 1 To make the favourites bar appear, press .
 - 2 Tap the small app that you want to open.
- 💡 You can open several small apps at the same time.

To close a small app

- Tap  on the small app window.

To download a small app

- 1 From the favourites bar, tap , then tap  and tap .
- 2 Search for the small app that you want to download, then follow the instructions to download it and complete the installation.

To move a small app

- When the small app is open, touch and hold the top left corner of the small app, then move it to the desired location.

To minimise a small app

- When the small app is open, touch and hold the top left corner of the small app, then drag it to the right edge or to the bottom edge of the screen.
- 💡 To minimise a small app, you can also drag down the status bar to open the Notification panel and then tap .

To rearrange the small apps in the favourites bar

- Touch and hold a small app and drag it to the desired position.





To remove a small app from the favourites bar

- 1 Touch and hold a small app, then drag it to .
- 2 Tap **OK**.

To restore a previously removed small app

- 1 Open the favourites bar, then tap .
- 2 Touch and hold the small app that you want to restore, then drag it into the favourites bar.

To add a widget as a small app

- 1 To make the favourites bar appear, press .
- 2 Tap  >  > .
- 3 Select a widget.
- 4 Enter a name for the widget, if desired, then tap **OK**.

Widgets

Widgets are small applications that you can use directly on your Home screen. They also function as shortcuts. For example, the Weather widget allows you to see basic weather information directly on your Home screen. But when you tap the widget, the full Weather application opens. You can download additional widgets from Google Play™.

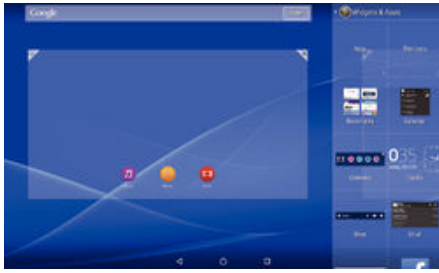

To add a widget to the Home screen

- 1 Touch and hold an empty area on your Home screen, then tap **Widgets & Apps**.
- 2 Find and tap the widget that you want to add.

To resize a widget

- 1 Touch and hold a widget until it magnifies, then release the widget. If the widget can be resized, for example, the Calendar widget, then a highlighted frame and resizing dots appear.
- 2 Drag the dots inward or outward to shrink or expand the widget.
- 3 To confirm the new size of the widget, tap anywhere on the Home screen.

To move a widget

- Touch and hold the widget until it magnifies, then drag it to the new location.

To delete a widget

- Touch and hold the widget until it magnifies, then drag it to **X**.

Shortcuts and folders

Use shortcuts and folders to manage your applications and keep your Home screen tidy.



- 1 Access an application using a shortcut
- 2 Access a folder containing applications

To add an application shortcut to your Home screen

- 1 Touch and hold an empty area on your Home screen.
- 2 In the customisation menu, tap **Widgets & Apps > Apps**.
- 3 Scroll through the list of applications and select an application. The selected application gets added to the Home screen.

- 💡 In step 3, alternatively, you can tap **Widgets & Apps > Shortcuts** and then select an application from the list available. If you use this method to add shortcuts, some of the applications available allow you to add specific functionality to the shortcut.

To move an item on the Home screen

- Touch and hold the item until it becomes selected, then drag the item to the new location.

To delete an item from the Home screen

- Touch and hold an item until it becomes selected, then drag the item to **X**.

To create a folder on the Home screen

- Touch and hold an application icon or a shortcut until it becomes selected, then drag and drop it on top of another application icon or shortcut.

To add items to a folder on the Home screen

- Touch and hold an item until it becomes selected, then drag the item to the folder.

To rename a folder on the Home screen

- 1 Tap the folder to open it.
- 2 Tap the folder's title bar to show the **Folder name** field.
- 3 Enter the new folder name and tap **Done**.

Background and themes

You can adapt the Home screen to your own style using wallpapers and different themes.



To change your Home screen wallpaper

- 1 Touch and hold an empty area on your Home screen.
- 2 Tap **Wallpapers** and select an option.

To set a theme

- 1 Touch and hold an empty area on your Home screen.
- 2 Tap **Themes**.
- 3 Select an option and follow the instructions in your device.

- ! When you change a theme, the background also changes in some applications.

Battery and power management

Your device has an embedded battery. You can keep track of your battery consumption and see which applications are using the most power. You can remove or restrict apps and activate a number of power saving modes to get more out of your battery. You can also view an estimate of how much battery time is left and adjust your battery settings to improve performance and make your battery last longer.

To manage your battery consumption

- 1 From your Home screen, tap .
- 2 Find and tap **Settings** > **Power management** > **App power consumption**. An overview appears showing applications that have high data traffic rates or that you have not used for a long time.
- 3 Review the information, then act as required, for example, to uninstall an application or restrict its usage.

To view which applications use the most battery power



- 1 From your Home screen, tap .
- 2 Find and tap **Settings** > **Power management** > **Battery usage**.

To view the estimated battery time

- 1 From your Home screen, tap .
- 2 Find and tap **Settings** > **Power management**.

Power saving modes

There are several power saving modes available for you to use if you want to make your battery last longer:

STAMINA mode	Disables Wi-Fi® and mobile data when the screen is turned off, and restricts hardware performance.  appears in the status bar when this mode takes effect.
Low battery mode	Modifies your device's behaviour, for example, to adjust screen brightness and the screen timeout setting, when the battery level drops below a certain percentage.  appears in the status bar when this mode takes effect.
Queue background data	Optimises outgoing traffic when the screen is off by sending data at pre-defined intervals.

- ! If you are using a device with multiple users, you may need to log in as the owner, that is, the primary user, to activate or deactivate a power saving mode.

To activate a power saving mode

- 1 From your Home screen, tap .
- 2 Find and tap **Settings** > **Power management**.
- 3 To activate your preferred mode, select the mode name and tap the on-off switch to activate the chosen mode, if necessary.

STAMINA mode feature overview

STAMINA mode has several features that allow you to optimise your battery performance:

Extended standby	Prevents applications from using data traffic by disabling Wi-Fi® and mobile data when the screen is off. You can exclude some applications and services from being paused when this feature is active.
STAMINA clock	Keeps network connections paused in situations where you frequently press the power key to check the time.
Extended usage	Restricts hardware performance when you are using your device.

- ! If you are using a device with multiple users, you may need to log in as the owner, that is, the primary user, to activate or deactivate a STAMINA mode feature.

To activate STAMINA mode features

- 1 From your Home screen, tap .
- 2 Find and tap **Settings** > **Power management**, then tap **STAMINA mode**.
- 3 Activate STAMINA mode if it is deactivated.
- 4 Drag the sliders beside the features that you want to activate, then tap **Activate**, if prompted.



To select which applications to run in STAMINA mode

- 1 From your Home screen, tap .
- 2 Find and tap **Settings** > **Power management**, then tap **STAMINA mode**.
- 3 Activate STAMINA mode if it is deactivated.
- 4 Make sure that the **Extended standby** feature is turned on, then tap **Apps active in standby** > **Add applications**.
- 5 Scroll left or right to view all applications and services, then mark the relevant checkboxes for the applications that you want to run.
- 6 When you're finished, tap **Done**.

Taking a screenshot

You can capture still images of any screen on your device as a screenshot. Screenshots you take are automatically saved in Album.

To take a screenshot

- 1 Press and hold down the power key until a prompt window appears.
 - 2 Tap .
-  You can also take a screenshot by pressing and holding the power key and volume down key at the same time. Once the screenshot is captured, you can release the keys.

To view your screenshot

- Drag the status bar fully downwards, then tap the screenshot you want to view.
-  You can also view your screenshots by opening the Album application.

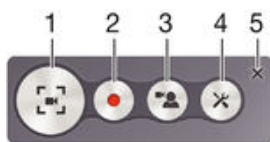

Recording your screen

You can use the screen recording feature to capture videos of what's happening on your device's screen. This feature is useful, for example, when you want to create tutorials or record videos of you playing a game on your device. Recorded video clips are automatically saved in Album.









- 1 Minimise/Resume the record screen window
- 2 Record your screen
- 3 Record your screen when the front camera is activated
- 4 Access the screen recording settings
- 5 Close the screen recording window

To record your screen

- 1 Press and hold down the power key until a prompt window appears.
- 2 Tap .
- 3 After the screen recording window opens, tap . The record screen function starts and a timer button is displayed.
- 4 To stop the recording, tap the timer button, then tap .

To record your screen when the front camera is activated

- 1 When the screen recording window opens, tap . A window opens showing a viewfinder for the front camera.
 - 2 To start recording your screen and video captured by the front camera, tap .
 - 3 To stop recording, tap the timer button, then tap .
 - 4 To close the front camera viewfinder window, tap .
-  To record a still photo using the front camera while you are recording the screen, drag  in the mini viewfinder to expand the view and then tap .

To view recent screen recordings

- Drag the status bar downwards, then tap to view the most recent recordings of your screen.
-  You can also view your screen recordings in the Album application.

Notifications

Notifications inform you of events such as new messages and calendar notifications as well as activities in progress such as file downloads. Notifications appear in the following places:

- The status bar
- The Notification panel
- The lock screen

To open or close the Notification panel



- 1 To open the Notification panel, drag the status bar downwards.
- 2 To close the Notification panel, drag the panel upwards.

To take action on a notification in the Notification panel

- Tap the notification.

To dismiss a notification from the Notification panel

- Place your finger on a notification and flick left or right.

To expand a notification on the Notification panel

- Drag the notification downwards.

-  Not all notifications are expandable.

To clear all notifications from the Notification panel

- Tap .

To take action on a notification from the lock screen

- Double-tap the notification.

To dismiss a notification from the lock screen

- Place your finger on the notification and flick left or right.

To expand a notification on the lock screen

- Drag the notification downwards.
- ! Not all notifications are expandable.

Managing notifications on the lock screen

You can set up your device so that only selected notifications get displayed on your lock screen. You can make all notifications and their content accessible, hide sensitive content for all notifications or specific apps, or choose not to show any notifications at all.

To select the notifications to display on the lock screen

- 1 From your Home screen, tap .
- 2 Find and tap **Settings** > **Sound & notification** > **When device is locked**.
- 3 Select an option.

Notification display options on the lock screen

Show all notification content	Get all notifications on the lock screen. When you have this setting turned on, keep in mind that all content (including the content of incoming emails and chats) will be visible on your lock screen unless you designate the relevant apps as Sensitive in the App notifications settings menu.
Hide sensitive notification content	You must have a PIN, password, or pattern set up as your screen lock in order for this setting to be available. Contents hidden is displayed on the lock screen when sensitive notifications arrive. For example, you'll get a notification for an incoming email or chat, but the content won't be visible on your lock screen.
Don't show notifications at all	You won't get any notifications on the lock screen.

Setting the notification level for an app

You can set different notification behaviour for individual applications. For example, you can block all email notifications, prioritise Facebook™ notifications and make the content of messaging notifications invisible on the lock screen.

To set the notification level for an app

- 1 From your Home screen, tap .
- 2 Find and tap **Settings** > **Sound & notification** > **App notifications**.
- 3 Select the app for which you want to change the notification settings.
- 4 Drag the relevant slider to the right.

Notification levels and options for specific applications

Block	Never show notifications for the selected app.
Priority	Show notifications for the selected apps at the top of the list on your lock screen.
Sensitive	This option is only available if you set up a PIN, password or pattern as your screen lock and selected Show all notification content under the When device is locked setting. Notifications for the app appear on your lock screen but their content is not visible.

Notification light

The notification light informs you about battery status and some other events. For example, a flashing white light means there is a new message or a missed call. The notification light is enabled by default but can be disabled manually.

















- ! When the notification light is disabled, it only lights up when there is a battery status warning, for example, when the battery level goes below 15 percent.





To enable the notification light

- 1 From your Home screen, tap .
- 2 Find and tap **Settings** > **Sound & notification**.
- 3 Drag the slider beside **Notification light** to the right.

Icons in the status bar

Status icons

	No SIM card
	Signal strength
	No signal
	Roaming
	Sending and downloading LTE data
	Sending and downloading GPRS data
	Sending and downloading EDGE data
	Sending and downloading 3G data
	Sending and downloading mobile data
	A Wi-Fi® connection is enabled and data is being transmitted
	Battery status
	The battery is charging
	STAMINA mode is activated
	Low battery mode is activated
	Airplane mode is activated
	The Bluetooth® function is activated
	The microphone is muted
	Silent mode
	Allow exceptions in silent mode
	Vibrate mode
	An alarm is set

























-  GPS is activated
-  Synchronisation is ongoing
-  Problem with sign-in or synchronisation
-  Your device is ready to connect to supported ANT+™ devices

! Depending on your service provider, network and/or region, the functions or services represented by some icons in this list may not be available.

To manage status bar icons

- 1 From your Home screen, tap .
- 2 Find and tap **Settings** > **Personalization** > **System icons**.
- 3 Mark the checkboxes for the system icons that you want to appear in the status bar.

Notification icons

-  New text message or multimedia message
-  Missed call
-  Call on hold
-  Call forwarding is turned on
-  New voicemail message
-  New email message
-  Downloading data
-  Uploading data
-  Mobile data is disabled
- Perform a basic setup of your device
-  A software update is available
-  System updates are available
-  Downloading system updates
-  Tap to install the downloaded system updates
-  Noise cancelling is on
-  Screenshot captured
-  New Hangouts™ chat message has arrived
-  Video chat with friends using the Hangouts™ application
-  Upcoming calendar event
-  A small app is running
-  Smart Connect is activated
-  A song is playing
-  The radio is playing
-  The device is connected to a computer via a USB cable
-  Internal storage is 75% full. Tap to transfer data to the memory card

 Warning





















 More (undisplayed) notifications

! Not all icons that may appear in your device are listed here. These icons are for reference purposes only, and changes may be made without notice.

To block an application from sending notifications

- 1 From your Home screen, tap .
- 2 Find and tap **Settings** > **Sound & notification** > **App notifications**.
- 3 Select an application.
- 4 Drag the slider beside **Block** to the right.

Application overview

-  Use the Alarm & clock application to set various kinds of alarms.
-  Use your web browser to navigate and view web pages, manage bookmarks, text and images.
-  Use the Calculator application to perform basic calculations.
-  Use the Calendar application to keep track of events and manage your appointments.
-  Use the camera to take photos and record video clips.
-  Use the Contacts application to manage phone numbers, email addresses and other information related to your contacts.
-  Access your downloaded applications, documents and pictures.
-  Use the Email application to send and receive emails through both private and corporate accounts.
-  Use the Facebook™ application to engage in social networking with friends, family members and colleagues around the world.
-  Browse and listen to FM radio stations.
-  Use the Album application to view and to work with your photos and videos.
-  Use the Gmail™ application to read, write and organise email messages.
-  Search for information in your device and on the web.
-  View your current location, find other locations and calculate routes using Google Maps™.
-  Use the Play Store™ application to download free and paid applications for your device.
-  Use the Messaging application to send and receive text and multimedia messages.
-  Use the Video application to play videos on your device and share content with your friends.
-  Use the Music application to organise and play music, audio books and podcasts.
-  View news stories and weather forecasts.
-  Make phone calls by dialling the number manually or by using the smart dial function.



Optimise settings to suit your own requirements.



Use the Hangouts™ application to chat with friends online.



Identify music tracks that you hear playing in your surroundings, and get artist, album and other info.



Use YouTube™ to share and view videos from around the world.



Use the Backup and restore application to back up or restore content on your device, such as contacts, text messages, bookmarks, calendar data, etc.



Use the Smart Connect™ application to set what happens in your device when you connect or disconnect an accessory.



The Xperia™ Movie Creator automatically creates short videos of around 30 seconds in length using existing photos and videos. The application automatically determines the timeline to create its movie.



Use the Lifelog application to automatically log events about your daily life. For example, you can set goals and track your progress in achieving them or bookmark special moments.



Use the Support application to access user support in your device. For example, you can access a User guide, troubleshooting information, plus tips and tricks.

! Some applications are not supported or listed by all networks and/or service providers in all areas.

Downloading applications

Downloading applications from Google Play™

Google Play™ is the official online Google store for downloading applications, games, music, movies and books. It includes both free and paid applications. Before you start downloading from Google Play™, make sure that you have a working Internet connection, preferably over Wi-Fi® to limit data traffic charges.

- ! To use Google Play™, you need to have a Google™ account. Google Play™ may not be available in all countries or regions.

To download an application from Google Play™

- 1 From the Home screen, tap .
- 2 Find and tap **Play Store**.
- 3 Find an item you wish to download by browsing categories, or by using the search function.
- 4 Tap the item to view its details, and follow the instructions to complete the installation.

- ! Some applications may need to access data, settings and various functions on your device in order to work properly. Only install and give permissions to applications that you trust.

- 💡 You can view the permissions granted to a downloaded application by tapping the application under **Settings > Apps**.

Downloading applications from other sources

When your device is set to allow downloads from sources other than Google Play™, you can download applications directly from other websites by following the relevant download instructions.

- ! Installing applications of unknown or unreliable origin can damage your device. Only download applications from reliable sources. Contact the application provider if you have any questions or concerns.
- ! If you are using a device with multiple users, only the owner, that is, the primary user, can allow downloads from sources other than Google Play™. Changes made by the owner affect all other users.

To allow the download of applications from other sources

- 1 From your Home screen, tap .
- 2 Find and tap **Settings > Security**.
- 3 Drag the slider beside **Unknown sources** to the right.
- 4 Tap **OK**.

- ! Some applications may need to access data, settings and various functions on your device in order to work properly. Only install and give permissions to applications that you trust.



- 💡 You can view the permissions granted to a downloaded application by tapping the application under **Settings > Apps**.

Internet and networks

Browsing the web

The Google Chrome™ web browser for Android™ devices comes pre-installed in most markets. Go to <http://support.google.com/chrome> and click the "Chrome for Mobile" link to get more detailed information about how to use this web browser.

To browse with Google Chrome™



- 1 From your Home screen, tap .
- 2 Find and tap .
- 3 If you are using Google Chrome™ for the first time, select to either sign in to a Google™ account or browse with Google Chrome™ anonymously.
- 4 Enter a search term or web address in the search and address field, then tap **Go** on the keyboard.

Internet and MMS settings



To send multimedia messages, or to access the Internet when there is no available Wi-Fi® network, you must have a working mobile data connection with the correct Internet and MMS (Multimedia Messaging Service) settings. Here are some tips:

- For most mobile networks and operators, Internet and MMS settings come pre-installed on your device. You can then start using the Internet and send multimedia messages right away.
 - In some cases, you get the option to download Internet and MMS settings the first time you turn on your device when a SIM card is inserted. It is also possible to download these settings later from the Settings menu.
 - You can manually add, change or delete Internet and MMS settings on your device at any time. If you change or delete an Internet or MMS setting by mistake, download the Internet and MMS settings again.
 - If you cannot access the Internet over a mobile network or if multimedia messaging is not working, even though the Internet and MMS settings have been downloaded successfully to your device, refer to the troubleshooting tips for your device at www.sonymobile.com/support/ for network coverage, mobile data, and MMS issues.
- ! If STAMINA mode is activated to save power, all mobile data traffic gets paused when the screen is off. If this causes connection problems, try excluding some applications and services from being paused, or deactivate STAMINA mode temporarily. For more information, see *STAMINA mode feature overview* on page 20 .
- ! If you are using a device with multiple users, only the owner, that is, the primary user, can download Internet and messaging settings from the Settings menu, but the downloaded settings are applicable to all users.

To download Internet and MMS settings

- 1 From your Home screen, tap .
 - 2 Find and tap **Settings** > **More** > **Internet settings**.
 - 3 Tap **Accept**. Once the settings have been downloaded successfully,  appears in the status bar and mobile data is turned on automatically.
- ! If the settings cannot be downloaded to your device, check the signal strength of your mobile network. Move to an open location free from obstructions or get close to a window and then try again.

To add Internet and MMS settings manually

- 1 From your Home screen, tap .
- 2 Find and tap **Settings** > **More** > **Mobile networks**.
- 3 Tap **Access Point Names** > **+**.
- 4 Tap **Name** and enter a name as desired.
- 5 Tap **APN** and enter the access point name.
- 6 Enter all other information as required. If you don't know what information is required, contact your network operator for more details.
- 7 When you're done, tap , then tap **SAVE**.

To view the downloaded Internet and MMS settings

- 1 From your Home screen, tap .
- 2 Find and tap **Settings** > **More** > **Mobile networks**.
- 3 Tap **Access Point Names**.
- 4 To view more details, tap any of the available items.



- ! If you have several available connections, the active network connection is indicated by a marked button .

Wi-Fi®

Use Wi-Fi® connections to surf the Internet, download applications, or send and receive emails. Once you have connected to a Wi-Fi® network, your device remembers the network and automatically connects to it the next time you come within range.

Some Wi-Fi® networks require you to log in to a web page before you can get access. Contact the relevant Wi-Fi® network administrator for more information.



Available Wi-Fi® networks may be open or secured:

- Open networks are indicated by  next to the Wi-Fi® network name.
 - Secured networks are indicated by  next to the Wi-Fi® network name.
- 💡 Some Wi-Fi® networks do not show up in the list of available networks because they do not broadcast their network name (SSID). If you know the network name, you can add it manually to your list of available Wi-Fi® networks.



To turn on Wi-Fi®

- 1 From your Home screen, tap .
 - 2 Find and tap **Settings** > **Wi-Fi**.
 - 3 Tap the on-off switch to turn on the Wi-Fi® function.
- ! It may take a few seconds before Wi-Fi® is enabled.

To connect to a Wi-Fi® network automatically

- 1 From your Home screen, tap .
 - 2 Find and tap **Settings** > **Wi-Fi**.
 - 3 Tap the on-off switch to turn on the **Wi-Fi** function. All available Wi-Fi® networks are displayed.
 - 4 Tap a Wi-Fi® network to connect to it. For secured networks, enter the relevant password.  is displayed in the status bar once you are connected.
- 💡 To search for new available networks, tap , then tap **Refresh**. If you cannot connect to a **Wi-Fi** network successfully, refer to the relevant troubleshooting tips for your device at www.sonymobile.com/support/.

To add a Wi-Fi® network manually

- 1 From your Home screen, tap .
 - 2 Find and tap **Settings** > **Wi-Fi**.
 - 3 Tap  > **Add network**.
 - 4 Enter the **Network name (SSID)** information.
 - 5 To select a security type, tap the **Security** field.
 - 6 If required, enter a password.
 - 7 To edit some advanced options such as proxy and IP settings, mark the **Advanced options** checkbox and then edit as desired.
 - 8 Tap **Save**.
- ! Contact your Wi-Fi® network administrator to get the network SSID and password.

Increasing Wi-Fi® signal strength

There are a number of things you can do to increase the strength of a Wi-Fi® signal:

- Move your device closer to the Wi-Fi® access point.
- Move the Wi-Fi® access point away from any potential obstructions or interference.
- Don't cover the Wi-Fi® antenna area of your device (the highlighted area in the illustration).

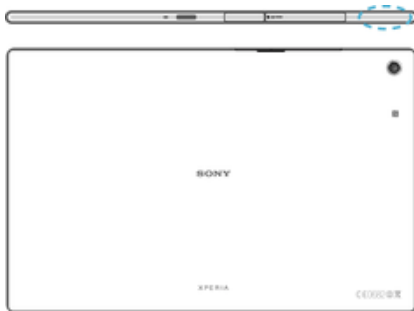



Wi-Fi® settings

When you are connected to a Wi-Fi® network or when there are Wi-Fi® networks available in your vicinity, it is possible to view the status of these networks. You can also enable your device to notify you whenever an open Wi-Fi® network is detected.

If you are not connected to a Wi-Fi® network, your device uses a mobile data connection to access the Internet (if you have set up and enabled a mobile data connection on your device). By adding a Wi-Fi® sleep policy, you can specify when to switch from Wi-Fi® to mobile data.



To enable Wi-Fi® network notifications

- 1 Turn on Wi-Fi®, if it is not already on.
- 2 From your Home screen, tap .
- 3 Find and tap **Settings** > **Wi-Fi**.
- 4 Tap  > **Advanced**.
- 5 Drag the slider beside **Network notification** to the right.

To view detailed information about a connected Wi-Fi® network

- 1 From the Home screen, tap .
- 2 Find and tap **Settings** > **Wi-Fi**.
- 3 Tap the Wi-Fi® network that you are currently connected to. Detailed network information is displayed.

To add a Wi-Fi® sleep policy

- 1 From the Home screen, tap .
- 2 Find and tap **Settings** > **Wi-Fi**.
- 3 Tap , then tap **Advanced** > **Keep Wi-Fi on during sleep**.
- 4 Select an option.



WPS

WPS (Wi-Fi® Protected Setup) is a wireless networking standard that helps you establish secure wireless network connections. If you have little background knowledge of wireless security, WPS makes it easy for you to set up Wi-Fi Protected Access (WPA) encryption to secure your network. You can also add new devices to an existing network without entering long passwords.



Use one of these methods to enable WPS:

- Push button method – simply push a button on a WPS-supported device, for example, a router.
- PIN method – your device creates a random PIN (Personal Identification Number), which you enter on the WPS-supported device.

To connect to a Wi-Fi® network using a WPS button

- 1 From your Home screen, tap .
- 2 Find and tap **Settings > Wi-Fi**.
- 3 Turn on Wi-Fi® if it is not already on.
- 4 Tap  > **Advanced > WPS Push Button**, then press the WPS button on the WPS-supported device.

To connect to a Wi-Fi® network using a WPS PIN



- 1 From your Home screen, tap .
- 2 Find and tap **Settings > Wi-Fi**.
- 3 Turn on Wi-Fi® if it is not already on.
- 4 Tap  > **Advanced > WPS PIN Entry**.
- 5 On the WPS-supported device, enter the PIN that appears on your device.

Sharing your mobile data connection



You can share your mobile data connection with other devices in several ways:

- USB tethering – share your mobile data connection with a single computer using a USB cable.
- Bluetooth® tethering – share your mobile data connection with up to five other devices via Bluetooth®.
- Portable Wi-Fi® hotspot – share your mobile data connection simultaneously with up to 8 other devices, including devices that support WPS technology.

To share your data connection using a USB cable



- 1 Deactivate all USB cable connections to your device.
 - 2 Using the USB cable that came with your device, connect your device to a computer.
 - 3 From your Home screen, tap .
 - 4 Find and tap **Settings > More > Tethering & portable hotspot**.
 - 5 Drag the slider beside **USB tethering** to the right, then tap **OK** if prompted.  is displayed in the status bar once you are connected.
 - 6 To stop sharing your data connection, drag the slider beside **USB tethering** to the left or disconnect the USB cable.
- ! You cannot share your device's data connection and SD card over a USB cable at the same time.

To share your mobile data connection with another Bluetooth® device

- 1 Make sure that your device and the Bluetooth® device are paired with each other and that mobile data traffic is activated on your device.
 - 2 **Your device:** From your Home screen, tap .
 - 3 Find and tap **Settings > More > Tethering & portable hotspot** and then drag the slider beside **Bluetooth tethering** to the right.
 - 4 **Bluetooth® device:** Set up the device so that it obtains its network connection using Bluetooth®. If the device is a computer, refer to the relevant instructions to complete the setup. If the device runs on the Android™ operating system, tap the settings icon beside the name of the device that it is paired with under **Settings > Bluetooth > Paired devices**, then mark the **Internet access** checkbox.
 - 5 **Your device:** Wait for  to appear in the status bar. Once it appears, the setup is complete.
 - 6 To stop sharing your mobile data connection, drag the slider beside **Bluetooth tethering** to the left.
- ! The **Bluetooth tethering** function is turned off every time you turn off your device or turn off the Bluetooth® function.

 For more information about pairing and turning on mobile data, see *To pair your device with another Bluetooth® device* on page 113 and *To add a virtual private network* on page 36 .

To use your device as a portable Wi-Fi® hotspot

- 1 From your Home screen, tap .
- 2 Find and tap **Settings > More > Tethering & portable hotspot**.
- 3 Tap **Portable Wi-Fi hotspot settings > Configure Wi-Fi hotspot**.
- 4 Enter the **Network name (SSID)** information.
- 5 To select a security type, tap the **Security** field. If required, enter a password.
- 6 Tap **Save**.
- 7 Tap  and drag the slider beside **Portable Wi-Fi hotspot** to the right.
- 8 If prompted, tap **OK** to confirm.  appears in the status bar once the portable Wi-Fi® hotspot is active.
- 9 To stop sharing your data connection via Wi-Fi®, drag the slider beside **Portable Wi-Fi hotspot** to the left.

To allow a WPS-supported device to use your mobile data connection

- 1 Make sure that your device is functioning as a portable Wi-Fi® hotspot.
- 2 From your Home screen, tap .
- 3 Find and tap **Settings > More > Tethering & portable hotspot > Portable Wi-Fi hotspot settings**.
- 4 Make sure that the **Discoverable** checkbox is marked.
- 5 Under **Configure Wi-Fi hotspot**, make sure that your portable hotspot is secured by a password.
- 6 Tap **WPS Push Button**, then follow the relevant instructions. Alternatively, tap **> WPS PIN Entry**, then enter the PIN that appears on the WPS-supported device.

To rename or secure your portable hotspot

- 1 From the Home screen, tap .
- 2 Find and tap **Settings > More > Tethering & portable hotspot**.
- 3 Tap **Portable Wi-Fi hotspot settings > Configure Wi-Fi hotspot**.
- 4 Enter the **Network name (SSID)** for the network.
- 5 To select a security type, tap the **Security** field.
- 6 If required, enter a password.
- 7 Tap **Save**.



Tethering with Xperia Link™

If you have an Xperia™ mobile phone, you can share the phone's mobile data connection with your Xperia™ tablet. This way, your tablet can connect to the Internet without having to use its own SIM card and data connection. This feature is

useful when you are out and about and don't have a mobile or Wi-Fi® connection on your tablet. Before you use tethering with Xperia Link™, make sure the Xperia Link™ application is installed and set up on both devices. Also, your Xperia™ phone must have a camera with auto focus.

- ! The Xperia Link™ application is only supported by Xperia™ phones running the Android™ 4.0 software version or higher. If the Xperia Link™ application is not pre-installed on your Xperia™ phone, you can download it from Google Play™.

To connect your tablet with an Xperia™ phone using Xperia Link™

- 1 Make sure the Bluetooth function is activated on both your Xperia™ phone and tablet and that the phone has an active mobile data connection.
- 2 **Tablet:** From your Home screen, tap  > **Xperia Link™** > **Setup**, then follow the instructions to complete the setup. A QR code™ appears on the screen.
- 3 **Phone:** From your Home screen, tap  > **Xperia Link™** > **Setup** > **Scan**.
- 4 Hold your phone over the QR code™ on the tablet screen until the complete QR code™ is visible in the viewfinder of the phone.
- 5 Your tablet automatically scans the QR code™ and connects to your Xperia™ phone once the QR code™ is recognised.
- 6 To confirm the connection, tap **OK**.

Controlling data usage

You can keep track of the amount of data transferred to and from your device over your mobile data or Wi-Fi® connection during a given period. For example, you can view the amount of data used by individual applications. For data transferred over your mobile data connection, you can also set data usage warnings and limits to avoid additional charges.

- ! If you are using a device with multiple users, only the owner, that is, the primary user, can adjust data usage settings. Adjusting data usage settings can help you keep greater control over data usage but cannot guarantee the prevention of additional charges.

To turn data traffic on or off

- 1 From your Home screen, tap .
- 2 Find and tap **Settings** > **Data usage**.
- 3 Drag the slider beside **Mobile data** to turn data traffic on or off.

- 💡 When data traffic is turned off, your device can still establish Wi-Fi®, NFC and Bluetooth® connections.

To set a data usage warning

- 1 Make sure that mobile data traffic is turned on.
- 2 From your Home screen, tap .
- 3 Find and tap **Settings** > **Data usage**.
- 4 To set the warning level, drag the warning line to the desired value. You receive a warning notification when the amount of data traffic approaches the level you set.

To set a mobile data usage limit

- 1 Make sure that mobile data traffic is turned on.
- 2 From your Home screen, tap .
- 3 Find and tap **Settings** > **Data usage**.
- 4 Drag the slider beside **Limit mobile data usage** to the right, then tap **OK**.
- 5 To set the mobile data usage limit, drag the data limit line to the desired value.



- ! Once your mobile data usage reaches the set limit, mobile data traffic on your device gets turned off automatically.

To control the data usage of individual applications

- 1 From your Home screen, tap .
- 2 Find and tap **Settings** > **Data usage**.
- 3 Tap the application that you want to control, then drag the slider beside **Restrict app background data** to the right and tap **OK**.
- 4 To access more specific settings for the application (if available), tap **App settings** and make the desired changes.

 The performance of individual applications may be affected if you change the related data usage settings.

To check your data usage

- 1 From your Home screen, tap .
- 2 Find and tap **Settings** > **Data usage**.
- 3 Tap , then tap **Show Wi-Fi**.
- 4 To view information about the amount of data transferred via Wi-Fi®, tap the **Wi-Fi** tab.
- 5 To view the information about the amount of data transferred via mobile data connection, tap the **Mobile** tab.

Selecting mobile networks

Your device automatically switches between mobile networks depending on which mobile networks are available where you are. You can also manually set your device to use a particular mobile network mode, for example, WCDMA or GSM.

Different status icons are displayed in the status bar depending on the type or mode of network that you are connected to. Refer to *Status icons* on page 24 to see what the different status icons look like.

To select a network mode

- 1 From your Home screen, tap .
- 2 Find and tap **Settings** > **More** > **Mobile networks**.
- 3 Tap **Preferred network type**, then select a network mode.

To select another network manually

- 1 From your Home screen, tap .
- 2 Find and tap **Settings** > **More** > **Mobile networks** > **Network operators**.
- 3 Tap **Search mode**, then select **Manual**.
- 4 Select a network.

 If you select a network manually, your device will not search for other networks, even if you move out of range of the manually selected network.

To activate automatic network selection

- 1 From your Home screen, tap .
- 2 Find and tap **Settings** > **More** > **Mobile networks** > **Network operators**.
- 3 Tap **Search mode**, then select **Automatic**.

Virtual private networks (VPNs)

Use your device to connect to virtual private networks (VPNs), which allow you to access resources inside a secured local network from a public network. For example, VPN connections are commonly used by corporations and educational institutions for users who need to access intranets and other internal services when they are outside of the internal network, for example, when they are travelling.

VPN connections can be set up in many ways, depending on the network. Some networks may require you to transfer and install a security certificate on your device. For detailed information on how to set up a connection to your virtual private network, please contact the network administrator of your company or organisation.

To add a virtual private network

- 1 From your Home screen, tap .
- 2 Find and tap **Settings** > **More** > **VPN**.
- 3 Tap **+**.
- 4 Select the type of VPN to add.
- 5 Enter your VPN settings.
- 6 Tap **Save**.

To connect to a virtual private network

- 1 From your Home screen, tap .
- 2 Find and tap **Settings** > **More** > **VPN**.
- 3 In the list of available networks, tap the VPN that you want to connect to.
- 4 Enter the required information.
- 5 Tap **Connect**.

To disconnect from a virtual private network

- 1 Drag the status bar downwards.
- 2 Tap the notification for the VPN connection to turn it off.

Synchronising data on your device

Synchronising with online accounts

Synchronise your device with contacts, email, calendar events and other information from online accounts, for example, email accounts such as Gmail™ and Exchange ActiveSync, Facebook™, Flickr™ and Twitter™. You can synchronise data automatically for all accounts by activating the auto-sync function. Or you can synchronise each account manually.



To set up an online account for synchronisation

- 1 From your Home screen, tap .
- 2 Tap **Settings** > **Accounts** > **Add account**, then select the account that you want to add.
- 3 Follow the instructions to create an account, or sign in if you already have an account.

To synchronise manually with an online account

- 1 From your Home screen, tap  > **Settings** > **Accounts**.
- 2 Under **Accounts**, select the account type, then tap the name of the account that you want to synchronise with. A list of items appears showing what can be synchronised with the account.
- 3 Tap the items that you want to synchronise.

To remove an online account

- 1 From your Home screen, tap  > **Settings** > **Accounts**.
- 2 Under **Accounts**, select the account type, then tap the name of the account that you want to remove.
- 3 Tap , then tap **Remove account**.
- 4 Tap **Remove account** again to confirm.



Synchronising with Microsoft® Exchange ActiveSync®

Using a Microsoft Exchange ActiveSync account, you can access your corporate email messages, calendar appointments and contacts directly on your device. After setup, you can find your information in the **Email**, **Calendar** and **Contacts** applications.

To set up an EAS account for synchronisation

- 1 Make sure that you have your domain and server details available (as provided by your corporate network administrator).
 - 2 From your Home screen, tap .
 - 3 Tap **Settings** > **Accounts** > **Add account** > **Exchange ActiveSync**.
 - 4 Enter your corporate email address and password.
 - 5 Tap **Next**. Your device begins to retrieve your account information. If a failure occurs, enter the domain and server details for your account manually and then tap **Next**.
 - 6 Tap **OK** to allow your corporate server to control your device.
 - 7 Select what data you want to sync with your device, such as contacts and calendar entries.
 - 8 If desired, activate the device administrator to allow your corporate server to control certain security features on your device. For example, you can allow your corporate server to set password rules and set storage encryption.
 - 9 When the setup is done, enter a name for the corporate account.
- ! When you change the login password for an EAS account on your computer, you have to log in again to the EAS account on your device.



To change the settings of an EAS account

- 1 From your Home screen, tap .
- 2 Tap **Email**, then tap .
- 3 Tap **Settings** and select an EAS account, then change the settings of the EAS account as desired.

To set a synchronisation interval for an EAS account

- 1 From your Home screen, tap .
- 2 Tap **Email**, then tap .
- 3 Tap **Settings** and select an EAS account.
- 4 Tap **Check frequency** > **Check frequency** and select an interval option.

To remove an EAS account

- 1 From your Home screen, tap  > **Settings** > **Accounts**.
- 2 Under **Accounts**, tap **Exchange ActiveSync**, then select the EAS account that you want to remove.
- 3 Tap , then tap **Remove account**.
- 4 Tap **Remove account** again to confirm.

Synchronising with Outlook® using a computer

You can use the Calendar and Contacts applications within the PC Companion and the Sony Bridge for Mac computer programs to synchronise your device with the calendar and contacts from your Outlook account. However, you cannot synchronise any data from your device to your computer.

- 💡 For more information on how to install the PC Companion on a PC or the Sony Bridge for Mac application on an Apple® Mac® computer, see *Computer tools* on page 127 .

To synchronise with your Outlook contacts using a computer

- 1 Make sure that the PC Companion application is installed on the PC or the Sony Bridge for Mac application is installed on the Apple® Mac® computer.
- 2 **Computer:** Open the PC Companion application or the Sony Bridge for Mac application.
- 3 Click **Start** to start the *Contacts* and *Contacts Sync* applications and follow the on-screen instructions to synchronise your device with your Outlook contacts.

To synchronise with your Outlook calendar using a computer

- 1 Make sure that the PC Companion application is installed on the PC or the Sony Bridge for Mac application is installed on the Apple® Mac® computer.
- 2 **Computer:** Open the PC Companion application or the Sony Bridge for Mac application.
- 3 Click **Start** to start the *Calendar* and *Calendar Sync* applications and follow the on-screen instructions to synchronise your device with your Outlook calendar.

Basic settings

Accessing settings

View and change settings for your device from the Settings menu. The Settings menu is accessible from both the Application screen and the Quick settings panel.

To open the device settings menu from the Application screen

- 1 From your Home screen, tap .
- 2 Tap **Settings**.

To view information about your device

- 1 From your Home screen, tap .
- 2 Find and tap **Settings** > **About tablet**.

To activate the screen using Tap to wake up mode

- 1 Make sure that Tap to wake up mode is turned on. To turn it on, tap **Settings** > **Display**, then drag the slider beside **Tap to wake up** to the right.
- 2 Double-tap the screen.

To open the Quick settings panel

- Using two fingers, drag the status bar downwards.

To select which settings to display on the Quick settings panel

- 1 Using two fingers, drag the status bar downwards, then tap .
- 2 In the bar at the top of the screen, touch and hold the icon for the quick setting that you want to add, then drag and drop it in the lower part of the screen.

To rearrange the Quick settings panel

- 1 Using two fingers, drag the status bar downwards, then tap .
- 2 Touch and hold an icon, then move it to the desired position.

Sound, ringtone and volume

You can adjust the ringtone volume for incoming calls and notifications as well as for music and video playback. You can set your device to silent mode and decide how long your device will be in silent mode manually. You can also preset when your device will be in silent mode automatically.

To adjust the ringtone volume with the volume key

- Press the volume key up or down.

To adjust the media playing volume with the volume key

- When playing music or watching video, press the volume key up or down even when the screen is locked.

To turn on vibrate mode

- Press the volume key down or up until  appears in the status bar.

To activate silent mode



- 1 Press the volume key down until  appears in the status bar.
- 2 Select a time interval.

Silent mode setting options

- Indefinitely** Keep the device silent until you manually turn the sound back on.

For one hour Keep the device silent for one hour. You can tap the minus and plus icons to adjust the duration.

To schedule silent mode time intervals

- 1 Press the volume key down until  appears in the status bar.
- 2 Tap .
- 3 Find and tap **Days** and mark the checkboxes for the relevant days, then tap **Done**.
- 4 To adjust the start time, tap **Start time** and select a value, then tap **OK**.
- 5 To adjust the end time, tap **End time** and select a value, then tap **OK**. Your device stays in silent mode during the selected time interval.

Setting exceptions for silent mode



You can select which types of notifications are allowed to sound in silent mode and you can filter exceptions based on who the notifications come from. The most common types of exceptions include:

- Events and reminders
- Calls
- Messages
- Alarms



To allow exceptions to sound in silent mode

- 1 Press the volume key down until  appears in the status bar.
- 2 Drag the slider beside **Allow exceptions** to the right.

To set notifications as exceptions in silent mode

- 1 Press the volume key down until  appears in the status bar.
- 2 Tap .
- 3 Under **Exceptions in Do not disturb mode**, drag the relevant sliders to the right.



To associate exceptions with specific contact types

- 1 Press the volume key down until  appears in the status bar.
- 2 Tap .
- 3 Find and tap **Calls/messages from**.
- 4 Select an option.

To allow alarms to sound in silent mode

- 1 Press the volume key down until  appears in the status bar.
- 2 Drag the slider beside **Allow alarm** to the right.

To allow exceptions to sound during a pre-set silent mode time interval

- 1 Press the volume key down until  appears in the status bar.
- 2 Tap .
- 3 Drag the slider beside **Exceptions** to the right.

To adjust the volume levels



- 1 From your Home screen, tap .
- 2 Find and tap **Settings** > **Sound & notification**.
- 3 Drag the volume sliders to the desired positions.

! You can also press the volume key up or down and then tap  to adjust the ringtone, media playback or alarm volume levels separately.



To set your device to vibrate for incoming calls

- 1 From your Home screen, tap .
- 2 Find and tap **Settings** > **Sound & notification**.
- 3 Drag the slider beside **Also vibrate for calls** to the right.

To set a ringtone

- 1 From your Home screen, tap .
- 2 Find and tap **Settings** > **Sound & notification** > **Phone ringtone**.
- 3 Select an option from the list or tap  and select a music file that is saved to your device.
- 4 To confirm, tap **Done**.

To select the notification sound

- 1 From your Home screen, tap .
- 2 Find and tap **Settings** > **Sound & notification** > **Notification sound**.
- 3 Select an option from the list or tap  and select a music file that is saved to your device.
- 4 To confirm, tap **Done**.

- 💡 Some applications have their own specific notification sounds, which you can select from the application settings.

To enable touch tones

- 1 From your Home screen, tap .
- 2 Find and tap **Settings** > **Sound & notification** > **Other sounds**.
- 3 Drag the sliders beside **Dialpad tones** and **Touch sounds** to the right.

SIM card protection

You can lock and unlock each SIM card that you use in your device with a PIN (Personal Identity Number). When a SIM card is locked, the subscription linked to the card is protected against misuse, meaning that you have to enter a PIN every time you start your device.

If you enter the PIN incorrectly more times than the maximum number of attempts allowed, your SIM card will become blocked. You then need to enter your PUK (Personal Unblocking Key) and a new PIN. Your PIN and PUK are supplied by your network operator.

To set up a SIM card lock

- 1 From the Home screen, tap .
- 2 Find and tap **Settings** > **Security** > **Set up SIM card lock**.
- 3 Mark the **Lock SIM card** checkbox.
- 4 Enter the SIM card PIN and tap **OK**. The SIM card lock is now active and you will be prompted to enter this lock every time you restart the device.

To remove a SIM card lock

- 1 From the Home screen, tap .
- 2 Find and tap **Settings** > **Security** > **Set up SIM card lock**.
- 3 Unmark the **Lock SIM card** checkbox.
- 4 Enter the SIM card PIN and tap **OK**.

To change the SIM card PIN

- 1 From the Home screen, tap .
- 2 Find and tap **Settings** > **Security** > **Set up SIM card lock**.
- 3 Tap **Change SIM PIN**.
- 4 Enter the old SIM card PIN and tap **OK**.
- 5 Enter the new SIM card PIN and tap **OK**.
- 6 Re-type the new SIM card PIN and tap **OK**.

To unlock a blocked SIM card using the PUK code

- 1 Enter the PUK code and tap ✓.
- 2 Enter a new PIN code and tap ✓.
- 3 Re-enter the new PIN code and tap ✓.

! If you enter an incorrect PUK code too many times, you need to contact your network operator to get a new SIM card.

Screen settings

To adjust the screen brightness

- 1 From your Home screen, tap .
- 2 Find and tap **Settings** > **Display** > **Brightness level**.
- 3 Drag the slider to adjust the brightness.

 Lowering the brightness level increases battery performance.

To set the screen to vibrate on touch

- 1 From your Home screen, tap .
- 2 Find and tap **Settings** > **Sound & notification** > **Other sounds**.
- 3 Drag the slider beside **Vibrate on touch** to the right. The screen now vibrates when you tap soft keys and certain applications.

To adjust the idle time before the screen turns off

- 1 From your Home screen, tap .
- 2 Find and tap **Settings** > **Display** > **Sleep**.
- 3 Select an option.

 To turn off the screen quickly, briefly press the power key .

Smart backlight control

The smart backlight control keeps the screen on as long as the device is held in your hand. Once you put down the device, the screen turns off according to your sleep setting.

To turn on the Smart backlight control function

- 1 From your Home screen, tap .
- 2 Find and tap **Settings** > **Display** > **Smart backlight control**.
- 3 Drag the slider to the right.

Screen pinning

Use screen pinning to set your device to display only the screen for a specific application. For example, if you are playing a game and you accidentally touch the Home navigation key, the screen pinning feature prevents the active game app screen from being minimised. You can also use this feature when you lend your device to another person to make it harder for them to access more than one application. For example, you can lend your device to somebody to take a photo and pin the screen to the Camera application so that the person can't easily use other apps such as Email.



! Screen pinning is not a security feature and does not fully prevent other users from unpinning a screen and accessing your device. To protect your data, you should set up your device to request a screen lock PIN, password or pattern before someone can unpin the screen.

To activate screen pinning



- 1 From your Home screen, tap .
- 2 Find and tap **Settings** > **Security** > **Screen pinning**.
- 3 Drag the slider to the right.
- 4 If you have not set up a pattern, PIN or password screen lock on your device, drag the slider beside **Lock device when unpinning** to the right and then select an option. If you already have a screen lock enabled, then drag the slider to activate the relevant security option after you activate screen pinning.

 A pattern, PIN or password is not mandatory for screen pinning to work.

To pin a screen

- 1 Make sure that screen pinning is activated on your device.
- 2 Open an app and go to the screen that you want to pin.
- 3 Tap .
- 4 To display the screen pinning icon , swipe upwards.
- 5 Tap .
- 6 In the popup window that appears, tap **Got it**.

To unpin a screen

- 1 On the pinned screen, touch and hold  and  at the same time.
- 2 Release both buttons.

 If you selected a security option when you activated the screen pinning function, you have to enter your pattern, PIN or password to unlock the device before the screen can be unpinned.

Daydream

Daydream is an interactive screen saver that automatically displays colours, photos or a slideshow while your device is docked or charging and the screen is idle.

 On a device with multiple users, each user can have individual Daydream settings.



To activate the Daydream screen saver

- 1 From your Home screen, tap .
- 2 Find and tap **Settings** > **Display** > **Daydream**.
- 3 Drag the slider to the right.

To select content for the Daydream screen saver

- 1 From your Home screen, tap .
- 2 Find and tap **Settings** > **Display** > **Daydream**.
- 3 Drag the slider to the right.
- 4 Select what you want to display when the screen saver is active.

To set when the Daydream screen saver starts

- 1 From your Home screen, tap .
- 2 Find and tap **Settings** > **Display** > **Daydream**.
- 3 Drag the slider to the right.
- 4 To activate the Daydream screen saver immediately, tap , then tap **Start now**.
- 5 To set automatic activation options, tap , then tap **When to daydream** and select an option.

Screen lock

There are several ways to lock the screen. The security level of each lock type is listed below in order of weakest to strongest:

- Swipe – no protection, but you have quick access to the Home screen
- Pattern – draw a simple pattern with your finger to unlock your device
- PIN – enter a numeric PIN of at least four digits to unlock your device

- Password – enter an alpha-numeric password to unlock your device
- ! It is very important that you remember your screen unlock pattern, PIN or password. If you forget this information, it may not be possible to restore important data such as contacts and messages.

To change screen lock type

- 1 From your Home screen, tap .
- 2 Find and tap **Settings** > **Security** > **Screen lock**.
- 3 Follow the instructions in your device and select another screen lock type.

To create a screen lock pattern

- 1 From your Home screen, tap .
- 2 Find and tap **Settings** > **Security** > **Screen lock** > **Pattern**.
- 3 Follow the instructions in your device.

- ! If your lock pattern is rejected five times in a row when you try to unlock your device, you must wait 30 seconds and then try again.

To change the screen lock pattern

- 1 From your Home screen, tap .
- 2 Find and tap **Settings** > **Security** > **Screen lock**.
- 3 Draw your screen unlock pattern.
- 4 Tap **Pattern** and follow the instructions in your device.

To create a screen lock PIN

- 1 From your Home screen, tap .
- 2 Find and tap **Settings** > **Security** > **Screen lock** > **PIN**.
- 3 Enter a numeric PIN, then tap **Continue**.
- 4 Re-enter and confirm your PIN, then tap **OK**.
- 5 Follow the instructions in your device.

To create a screen lock password

- 1 From your Home screen, tap .
- 2 Find and tap **Settings** > **Security** > **Screen lock** > **Password**.
- 3 Enter a password, then tap **Continue**.
- 4 Re-enter and confirm your password, then tap **OK**.
- 5 Follow the instructions in your device.

To activate the Swipe unlock function

- 1 From your Home screen, tap .
- 2 Find and tap **Settings** > **Security** > **Screen lock**.
- 3 Draw your screen unlock pattern, or enter your PIN or password if one of these screen lock types is enabled.
- 4 Tap **Swipe**.

Unlocking your device automatically

The Smart Lock feature makes unlocking your device easier by letting you set it to unlock automatically in certain situations. You can keep your device unlocked, for example, when it's connected to a Bluetooth® device or when you're carrying it with you.

To prepare your device to unlock automatically, you first need to perform the following steps in the order given:

- Make sure you have an active Internet connection, preferably a Wi-Fi® connection to limit data traffic charges.
- Make sure that all your apps are updated using the Play Store™ application in order to ensure that the Google Play™ services app is updated. Having an up-to-date Google Play™ services app ensures that you can use the latest Smart Lock features.
- Enable Smart Lock.

- Set when you want your device to unlock automatically.
- ! The Smart Lock feature is developed by Google™ and the exact functionality may change over time due to updates from Google™.
- ! The Smart Lock feature may not be available in every market, country or region.

To enable Smart Lock

- 1 Make sure that you've set a pattern, PIN or password for your screen lock.
- 2 From your Home screen, tap .
- 3 Find and tap **Settings > Security > Trust agents**.
- 4 Drag the slider beside **Smart Lock (Google)** to the right.
- 5 Tap the back arrow next to **Trust agents**.
- 6 Find and tap **Smart Lock**.
- 7 Enter your pattern, PIN or password. You need to enter this screen lock any time you want to change your Smart Lock settings.
- 8 Select a Smart Lock type.

Setting when to keep the device automatically unlocked

You can set Smart Lock to keep your device unlocked using the following settings:

- **Trusted devices** — Keep your device unlocked when a trusted Bluetooth® device is connected.
- **Trusted places** — Keep your device unlocked when you're in a trusted location.
- **On-body detection** — Keep your device unlocked when you're carrying your device with you.

You have to manually unlock your device when you don't use it for 4 hours and after you restart it.

Connecting to trusted Bluetooth® devices

You can designate a connected Bluetooth® device as a "trusted" device and keep your Xperia™ device unlocked while it's connected to it. So if you have Bluetooth® devices that you connect to regularly, for example, a car speaker or home entertainment system, a Bluetooth® watch, or a fitness tracker, you can add them as trusted devices and bypass the added security of a lockscreen to save time. This feature is suitable if you're normally in a relatively secure place when you use these devices. In some cases, you may still need to manually unlock your device before a trusted device can be connected.

- ! It is not recommended to add devices that are constantly connected to your device as trusted devices, for example, Bluetooth® keyboards or cases.
- 💡 As soon as a trusted Bluetooth® device is switched off or moves out of range, your screen locks and you need your PIN, pattern or password to unlock it.

To add a trusted Bluetooth® device

- 1 Make sure your device is paired and connected to the Bluetooth® device that you want to add as a trusted device.
- 2 In the Smart Lock menu, tap **Trusted devices**.
- 3 Tap **Add trusted device > Bluetooth**.
- 4 Tap a device name to select it from the list of connected devices. Only paired devices appear in this list.
- 5 Depending on the security of your connection, you may need to manually unlock your device before the trusted device can keep it unlocked.

To remove a trusted Bluetooth® device

- 1 From your Home screen, tap .
- 2 Find and tap **Settings > Security > Smart Lock > Trusted devices**.
- 3 Tap the device that you want to remove.
- 4 Tap **Remove trusted device**.

Making sure you're secure when using trusted devices

Different Bluetooth® devices support different Bluetooth® standards and security capabilities. There's a possibility that someone could keep your Xperia™ device unlocked by imitating your Bluetooth® connection, even if your trusted device is no longer nearby. Your device is not always able to determine whether your connection is secure from someone trying to imitate it.

When your device can't determine that you're using a secure connection, you'll get a notification on your Xperia™ device and may need to manually unlock it before the trusted device can keep it unlocked.

Bluetooth® connectivity range can vary depending on factors like the model of your device, the connected Bluetooth® device, and your environment. Depending on these factors, Bluetooth® connections can work over distances up to 100 meters. If someone takes your Xperia™ device while it's near a trusted device, they may be able to access your Xperia™ device if the trusted device has unlocked it.

Connecting to trusted places

When the Trusted places feature is set up, the lock screen security on your Xperia™ device gets disabled when you are in a designated trusted location. For this feature to work, you must have an Internet connection (preferably over Wi-Fi®) and allow your device to use your current location.

To set up trusted places, first make sure that high accuracy location mode or battery-saving location mode is enabled on your device before you add home or custom locations.

- ! The exact dimensions of a trusted location are an estimate and may extend beyond the physical walls of your home or other area that you have added as a trusted location. This feature can keep your device unlocked within a radius of up to 80 meters. Also be aware that location signals can be replicated or manipulated. Someone with access to specialised equipment could unlock your device.

To add your home location

- 1 Make sure location mode is turned on and that you are using either the **High accuracy** or **Battery saving** setting.
- 2 From your Home screen, tap .
- 3 Find and tap **Settings** > **Security** > **Smart Lock** > **Trusted places** > **Home**.
- 4 Tap **Turn on this location**.

To edit your home location

- 1 Make sure location mode is turned on and that you are using either the **High accuracy** or **Battery saving** setting.
- 2 From your Home screen, tap .
- 3 Find and tap **Settings** > **Security** > **Smart Lock** > **Trusted places**.
- 4 Select your home location.
- 5 Tap **Edit**.
- 6 In the search bar, enter the location that you want to use as your home location.

- 💡 If your home has multiple buildings at the same address, the trusted place that you want to add might be different from the actual address. To ensure better location accuracy, you can add the actual location of your home within the building complex as a custom place.

To remove your home location

- 1 Make sure location mode is turned on and that you are using either the **High accuracy** or **Battery saving** setting.
- 2 From your Home screen, tap .
- 3 Find and tap **Settings** > **Security** > **Smart Lock** > **Trusted places** > **Home**.
- 4 Tap **Turn off this location**.

Using custom locations

You can add any location as a trusted, custom place where your device can remain unlocked.

To add a custom place

- 1 Make sure location mode is turned on and that you are using either the **High accuracy** or **Battery saving** setting.
- 2 From your Home screen, tap .
- 3 Find and tap **Settings > Security > Smart Lock > Trusted places**.
- 4 Tap **Add trusted place**.
- 5 To use your current location as a trusted, custom place, tap **Select this location**.
- 6 Alternatively, to enter another location, tap the magnification glass icon and type the address. Your device searches for the entered location. To use the suggested address, tap the address.
- 7 To fine-tune the location, tap the back arrow next to the address, then drag the location pin to the desired location, and tap **Select this location**.

To edit a custom place

- 1 Make sure location mode is turned on and that you are using either the **High accuracy** or **Battery saving** setting.
- 2 From your Home screen, tap .
- 3 Find and tap **Settings > Security > Smart Lock > Trusted places**.
- 4 Select the place that you want to edit.
- 5 Tap **Edit address**.
- 6 To enter another location, tap the magnification glass icon and type the address. Your device searches for the entered location. To use the suggested address, tap the address.
- 7 To fine-tune the location, tap the back arrow next to the address, then drag the location pin to the desired location, and tap **Select this location**.

To remove a custom place

- 1 Make sure location mode is turned on and that you are using either the **High accuracy** or **Battery saving** setting.
- 2 From your Home screen, tap .
- 3 Find and tap **Settings > Security > Smart Lock > Trusted places**.
- 4 Select the place that you want to remove.
- 5 Tap **Delete**.

Keeping your device unlocked while you're carrying it

Using the On-body detection feature, you can have your device stay unlocked when you have it on you, for example, if you're carrying it in your hand, pocket or bag. The accelerometer in your device keeps your device unlocked when it senses that it's being carried. The device locks when the accelerometer detects that the device has been put down.

- ! The On-body detection feature can't distinguish whose body is connected. If you give your device to someone else while it's unlocked using On-body detection, your device may stay unlocked for the other user. Keep in mind that On-body detection as a security feature is less secure than a pattern, PIN, or password.

To enable On-body detection

- 1 From your Home screen, tap .
- 2 Find and tap **Settings > Security > Smart Lock > On-body detection**.
- 3 Drag the slider beside **Off** to the right, then tap **OK**.

Using On-body detection

When you use the On-body detection feature, you need to be aware of the following behaviours:

- When your device senses that it's on your body, it stays unlocked after you unlock it.
- Any time you put your device down and it senses that it's no longer on your body, your device locks automatically.
- After you put your device down, for example, if you place it on a table, your device can take up to one minute to lock.
- After you get into a car, bus, train or other land vehicles, your device can take between 5 and 10 minutes to lock.
- Note that when you get on an airplane or a boat (or other non-land based vehicles), your device may not lock automatically, so make sure to lock it manually if needed.
- When you pick up your device again or get out of the vehicle, just unlock it once and your device then stays unlocked for as long as you have it on you.



To turn off On-body detection

- 1 From your Home screen, tap .
- 2 Find and tap **Settings** > **Security** > **Smart Lock** > **On-body detection**.
- 3 Drag the slider beside **On** to the right.

Language settings

You can select a default language for your device and change it again at a later time. You can also change the writing language for text input. See *Personalising the on-screen keyboard* on page 55 .

To change the language

- 1 From the Home screen, tap .
 - 2 Find and tap **Settings** > **Language & input** > **Language**.
 - 3 Select an option.
 - 4 Tap **OK**.
- ! If you select the wrong language and cannot read the menu texts, find and tap . Then select the text beside  and select the first entry in the menu that opens. You can then select the language you want.

Date and time

You can change the date and time on your device.

To set the date manually

- 1 From the Home screen, tap .
- 2 Find and tap **Settings** > **Date & time**.
- 3 Drag the slider beside **Automatic date & time** to the left.
- 4 Tap **Set date**.
- 5 Scroll up and down to select the desired date.
- 6 Tap **OK**.

To set the time manually

- 1 From your Home screen, tap .
- 2 Find and tap **Settings** > **Date & time**.
- 3 Drag the slider beside **Automatic date & time** to the left.
- 4 Tap **Set time**.
- 5 Select the relevant values for the hour and minute.
- 6 Tap **OK**.

To set the time zone

- 1 From your Home screen, tap .
- 2 Find and tap **Settings** > **Date & time**.
- 3 Drag the slider beside **Automatic time zone** to the left.
- 4 Tap **Select time zone**.
- 5 Select an option.

X-Reality™ for mobile

Sony's X-Reality™ for mobile technology improves the viewing quality of photos and videos after you take them, giving you clearer, sharper and more natural images. X-Reality™ for mobile is turned on by default, but you can turn it off if you want to reduce battery consumption.

To turn on X-Reality™ for mobile

- 1 From your Home screen, tap .
- 2 Find and tap **Settings** > **Display** > **Image enhancement**.
- 3 Tap the **X-Reality for mobile** radio button if it is not already selected.

Super-vivid mode

Super-vivid mode enhances the colour brightness and saturation of your photos and videos while you view them on your device.

To turn on Super-vivid mode

- 1 From your Home screen, tap .
- 2 Find and tap **Settings** > **Display** > **Image enhancement**.
- 3 Tap the **Super-vivid mode** radio button if it is not already selected.

Enhancing the sound output

You can enhance the sound of your device by manually enabling individual sound settings such as Equaliser and Surround sound. You can also enable the Dynamic normaliser to minimise volume differences between songs or videos.

To enhance the sound output manually

- 1 From your Home screen, tap .
- 2 Find and tap **Settings** > **Sound & notification** > **Audio settings**.
- 3 Drag the slider beside **ClearAudio+** to the right.

To adjust the sound settings manually

- 1 From the Home screen, tap .
- 2 Find and tap **Settings** > **Sound & notification** > **Audio settings**.
- 3 Drag the slider beside **ClearAudio+** to the left.
- 4 Tap **Sound effects**.
- 5 Adjust the sound settings by dragging the frequency band buttons up or down.

-  The manual adjustment of sound output settings has no effect on voice communication applications. For example, there is no change in the voice call sound quality.

To minimise volume differences using the Dynamic normaliser

- 1 From the Home screen, tap .
- 2 Find and tap **Settings** > **Sound & notification** > **Audio settings**.
- 3 Drag the slider beside **Dynamic normalizer** to the right.

Noise cancellation

Your device supports noise cancelling headsets. By using a noise cancelling headset with your device, you can get much clearer audio quality when listening, for example, to music in a noisy environment, such as on a bus, a train or a plane. You can also use this feature to create a silent environment in which to study, work or read.

-  To ensure optimal performance, noise cancelling headsets from Sony are recommended.

To use a noise cancelling headset

- 1 Connect the noise cancelling headset to your device.
 - 2 From your Home screen, tap  > **Settings** > **Sound & notification** > **Accessory settings** > **Noise canceling**, then drag the slider beside **Noise canceling** to the right.
 - 3 If you want **Noise canceling** to be enabled only during music or video playback or when the screen is active, drag the slider beside **Power save mode** to the right.
 - 4 If you want **Noise canceling** to be enabled for as long as the headset is connected, drag the slider beside **Power save mode** to the left.
- ! A noise cancelling headset may not be included with your device at purchase.

To adjust the settings to the noise environment

- 1 Make sure a noise cancelling headset is connected to your device.
- 2 From your Home screen, tap .
- 3 Find and tap **Settings** > **Sound & notification** > **Accessory settings** > **Noise canceling** > **Noise environment**.
- 4 Select the relevant noise environment type, then tap **OK**.

Multiple user accounts

Your device supports multiple user accounts so that different users can log in separately to the device and use it. Multiple user accounts work well in situations where you share the same device with other people or lend your device to someone to use for a while. The user who sets up the device for the first time becomes the owner of the device. Only the owner can manage the accounts of other users. Apart from the owner account, there are two different types of accounts:

- Regular User: This account type is suitable for someone who regularly uses your device.
 - Guest User: Enable the guest account option for someone who just wants to use your device temporarily.
- ! Some features are only available to the owner. For example, only the owner can allow downloads from sources other than Google Play™.



About the Regular User account

By adding Regular User accounts, you can allow different users to have different home screens, wallpapers and general settings. They also get separate access to applications and memory storage for files such as music and photos. You can add up to three regular user accounts on your device.



To add a regular user account

- 1 Make sure you are logged in as the owner, that is, the user who set up the device for the first time.
 - 2 From your Home screen, tap .
 - 3 Find and tap **Settings** > **Users** > **Add user**.
 - 4 Tap **OK**. The new account is created.
 - 5 Tap **Set up now**. The screen locks and an icon representing the newly added user appears in the top right corner.
 - 6 Unlock the screen by swiping upwards.
 - 7 Follow the on-screen instructions to set up the account for the user.
- 💡 In cases where the person using the new account wants to set up the account but is not available at the time, you can tap **Not now** in step 5. When the user is ready, they can select **Users** under **Settings** and see the new account, which appears as **New user**. Just tap the account and follow the instructions to finish setting it up.
- 💡 You can also add a regular user account from the status bar on any screen. Just drag the status bar downwards using two fingers and tap the user icon, then tap **Add user**.

To allow a regular user to make phone calls and use SMS

- 1 Make sure you are logged in as the owner.
- 2 From your Home screen, tap .
- 3 Find and tap **Settings > Users**.
- 4 Tap  beside the name of the relevant user, then drag the slider beside **Allow phone calls and SMS** to the right.



To delete a regular user account from your device

- 1 Make sure you are logged in as the owner.
- 2 From your Home screen, tap .
- 3 Find and tap **Settings > Users**.
- 4 Tap  beside the name of the user that you want to delete, then tap **Remove user > Delete**.



About the Guest User account

If someone just wants to use your device temporarily, you can enable a guest account for this user. In guest mode, your device starts up as a freshly installed system with only the pre-installed apps. Once your guest is finished using your device, you can wipe the session clean so that the next guest can start fresh. The guest user account is pre-installed and cannot be deleted.



To set up the guest user account

- 1 Make sure you are logged in as the owner, that is, the user who set up the device for the first time.
 - 2 From your Home screen, tap .
 - 3 Find and tap **Settings > Users > Guest**.
 - 4 Follow the on-screen instructions to complete the procedure.
-  You can also set up a guest user account from the status bar on any screen. Just drag the status bar downwards using two fingers and tap the user icon, then tap **Add guest**.

To allow the guest user to make phone calls



- 1 Make sure you are logged in as the owner.
- 2 From your Home screen, tap .
- 3 Find and tap **Settings > Users**.
- 4 Tap  beside **Guest**, then drag the slider beside **Allow phone calls** to the right.

To clear the guest session data

- 1 Make sure you are logged in to the guest account.
 - 2 From your Home screen, tap .
 - 3 Find and tap **Settings > Users**.
 - 4 Find and tap **Remove guest**.
 - 5 Tap **Remove**.
-  You can also clear the guest session from the status bar on any screen as long as you are logged in to the guest account. Just drag the status bar downwards using two fingers and tap the user icon, then tap **Remove guest**.

Switching between multiple user accounts

To switch between multiple user accounts

- 1 To view the list of users, drag the status bar downwards using two fingers, then tap the user icon at the top right of the screen.
 - 2 Tap the icon representing the user account that you want to switch to. The lock screen for that user account appears.
-  When you switch to the guest account, tap **Start again** if you want to wipe the previous session or tap **Yes, continue** to continue the previous session.
-  Each user can set their own lock screen. See *Screen lock* on page 43.

Settings for multiple user accounts

There are three different types of settings on devices with multiple users:

- Settings that can be changed by any user and affect all users. Examples include language, Wi-Fi®, Airplane mode, NFC and Bluetooth®.
- Settings that only affect an individual user account. Examples include automatic data syncing, screen lock, various accounts added, and wallpaper.
- Settings that are only visible to the owner and affect all users, for example, VPN settings.

Typing text

On-screen keyboard

You can enter text with the on-screen QWERTY keyboard by tapping each letter individually, or you can use the Gesture input feature and slide your finger from letter to letter to form words. If you prefer to use a smaller and moveable version of the on-screen keyboard, you can activate the thumb keyboard or the mini keyboard instead.

You can select up to three languages for text input. The Smart language detection feature detects the language that you are using and predicts the words for that language as you type.



- 1 Delete a character before the cursor.
- 2 Enter a carriage return or confirm text input.
- 3 Switch between lower case ⇧, upper case ⇧ and caps ⇧. For some languages, this key is used to access extra characters in the language.
- 4 Shift to the moveable thumb keyboard or the mini keyboard.
- 5 Enter a space.
- 6 Personalise your keyboard. This key disappears after the keyboard is personalised.
- 7 Display numbers and symbols. For even more symbols, tap = & \$.

To display the on-screen keyboard to enter text

- Tap a text entry field.





To enter text character by character

- 1 To enter a character visible on the keyboard, tap the character.
- 2 To enter a character variant, touch and hold a regular keyboard character to get a list of available options, then select from the list. For example, to enter "é", touch and hold "e" until other options appear, then, while keeping your finger pressed on the keyboard, drag to and select "é".



To enter a period

- After you enter a word, double-tap the space bar.

To switch between the full keyboard and a smaller keyboard

- 1 When you enter text using the on-screen keyboard, tap ,  or .
 - 2 Select a keyboard.
- 💡 Tap and hold , then drag it to move the small keyboard as desired.

To change the Gesture input settings

- 1 When the on-screen keyboard is displayed, tap .
- 2 Tap , then tap **Keyboard settings**.
- 3 To activate or deactivate the Gesture input function, drag the slider beside **Gesture input** to the on or off position.





To enter text using the Gesture input function

- 1 When the on-screen keyboard is displayed, slide your finger from letter to letter to trace the word that you want to write.
- 2 After you finish entering a word, lift up your finger. A word suggestion appears based on the letters that you have traced.
- 3 If the word that you want does not appear, tap  to see other options and select accordingly. If the desired option does not appear, delete the entire word and trace it again, or enter the word by tapping each letter individually.



Entering text using voice input



When you enter text, you can use the voice input function instead of typing the words. Just speak the words that you want to enter. Voice input is an experimental technology from Google™, and is available for a number of languages and regions.

To enable voice input

- 1 When the on-screen keyboard is displayed, tap .
- 2 Tap , then tap **Keyboard settings**.
- 3 Drag the slider beside **Google™ voice typing key** to the right.
- 4 Tap  to save your settings. A microphone icon  now appears on your on-screen keyboard.

To enter text using voice input

- 1 Open the on-screen keyboard.
- 2 Tap . When  appears, speak to enter text.
- 3 When you're finished, tap  again. The suggested text appears.
- 4 Edit the text manually if necessary.

 To make the keyboard appear and enter text manually, tap .



Editing text

You can select, cut, copy and paste text as you write. You can access the editing tools by double-tapping the entered text. The editing tools then become available via an application bar.

Application bar



- 1 Close the application bar
- 2 Select all text
- 3 Cut text
- 4 Copy text
- 5 Paste text

  only appears when you have text saved on the clipboard.

To select text

- 1 Enter some text, then double-tap the text. The word you tap gets highlighted by tabs on both sides.
- 2 Drag the tabs left or right to select more text.

To edit text

- 1 Enter some text, then double-tap the entered text to make the application bar appear.
- 2 Select the text that you want to edit, then use the tools in the application bar to make your desired changes.

To use the magnifier



- When you enter text, tap and hold on the text field to view the text magnified and to place the cursor where you want within the text field.

Personalising the on-screen keyboard



When entering text using the on-screen keyboard, you can access keyboard and other text input settings that help you, for example, to set options for writing languages, text prediction and correction. You can get word suggestions for one language at a time by deactivating the Smart language detection feature.

The keyboard can use text that you have written in messaging and other applications to learn your writing style. There is also a Personalisation guide that runs you through the most basic settings to get you started quickly. You can select to use other keyboards and switch between keyboards. For example, you can select the Xperia™ Chinese keyboard or the Xperia™ Japanese keyboard.

To access the on-screen keyboard settings

- 1 When you enter text using the on-screen keyboard, tap .
- 2 Tap , then tap **Keyboard settings** and change the settings as desired.
- 3 To add a writing language for text input, tap **Writing languages** and mark the relevant checkboxes.
- 4 Tap **OK** to confirm.

To change the word suggestion settings

- 1 When you enter text using the on-screen keyboard, tap .
- 2 Tap , then tap **Keyboard settings** > **Word suggestions**.
- 3 Select an option.



To select a keyboard

- 1 When you enter text using the on-screen keyboard, tap  at the bottom right of the screen.
 - 2 Select an option.
- 💡 To enable more keyboard options, tap **Choose keyboards**, then drag the relevant sliders to the right.

To change writing language using the on-screen keyboard

- When you enter text using the on-screen keyboard, tap the writing language icon to switch between the selected writing languages. For example, tap  until the desired writing language appears.
- ! This feature is only available if you have added more than one input language.



To change the Smart language detection settings

- ! Smart language detection may not be available for all writing languages.
- 1 When the on-screen keyboard is displayed, tap .
 - 2 Tap , then tap **Keyboard settings**.
 - 3 To activate or deactivate the Smart language detection function, drag the slider beside **Smart language detection** to the on or off position.

To use your writing style

- 1 When you enter text using the on-screen keyboard, tap .
- 2 Tap , then tap **Keyboard settings** > **Use my writing style** and select a source.

To select a keyboard layout variant

- ! Layout variants for the on-screen keyboard may not be available for all writing languages. You can select different keyboard layouts for each writing language.
- 1 When you enter text using the on-screen keyboard, tap .
- 2 Tap , then tap **Keyboard settings**.
- 3 Tap **Writing languages**, then tap  beside a writing language.
- 4 Select a keyboard layout variant.
- 5 Tap **OK** to confirm.

Calling

Making calls

You can make a call by manually dialling a phone number, by tapping a number saved in your contacts list, or by tapping the phone number in your call log view. You can also use the smart dial function to quickly find numbers from your contacts list and call logs by entering part of a contact number or name and selecting from the suggestions that appear. To make a video call, you can use the Hangouts™ instant messaging and video chat application on your device. See *Instant messaging and video chat* on page 71 .

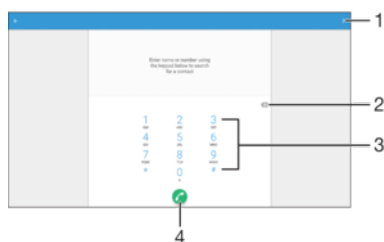



1 View more options

2 Delete number



3 Dialpad

4 Call button

To open the dialpad

- 1 From your Home screen, tap .
- 2 Find and tap .
- 3 If the dialpad does not appear, tap .

To dial a phone number

- 1 Open the dialpad.
 - 2 Enter the phone number, then tap .
-  To delete a number entered by mistake, tap .

To make a call using the smart dial function

- 1 Open the dialpad.
- 2 Enter letters or numbers that correspond to the contact you want to call. As you enter each letter or number, a list of possible matches appears.
- 3 Tap the contact that you want to call.

To make an international call

- 1 Open the dialpad.
- 2 Touch and hold 0 until a "+" sign appears.
- 3 Enter the country code, area code (without the initial zeros) and phone number, then tap .

To add a direct dial number to your Home screen

- 1 Touch and hold an empty area on your Home screen.
- 2 In the customisation menu, tap **Widgets & Apps > Shortcuts**.
- 3 Scroll through the list of applications and select **Direct dial**.
- 4 Select the contact and the number that you want to use as the direct dial number.

Showing or hiding your phone number

You can select to show or hide your phone number on call recipients' devices when you call them.

To show or hide your phone number

- 1 From the Home screen, tap .
- 2 Find and tap **Settings** > **Call** > **Additional settings** > **Caller ID**.

Receiving calls

If you receive an incoming call when the device is in sleep mode or the screen is locked, the phone application opens in fullscreen format. If you receive an incoming call when the screen is active, the incoming call is displayed as a floating notification, that is, in a minimised window that floats at the top of whatever screen is open. When such a notification arrives, you can choose to answer the call and open the phone application screen, or you can reject the call and stay on the current screen.

To answer an incoming call when the screen is inactive

- Drag  to the right.

To answer an incoming call when the screen is active

- In the floating notification that appears at the top of the screen, tap **ANSWER**.
- 💡 Instead of answering the call, you can go to the main phone application screen by tapping the upper part of the floating notification window. Using this method, you get more options to manage the call. For example, you can decide to reject the call with a message or forward the call to the answering machine.

To reject an incoming call when the screen is inactive

- Drag  to the left.

To reject an incoming call when the screen is active

- In the floating notification that appears at the top of the screen, tap **DECLINE**.
- 💡 Instead of rejecting the call, you can go to the main phone application screen by tapping the upper part of the floating notification window. Using this method, you get more options to manage the call. For example, you can decide to reject the call with a message or forward the call to the answering machine.

To mute the ringtone for an incoming call

- When you receive the call, press the volume key.

Using the answering machine

You can use the answering machine application in your device to answer calls when you are busy or miss a call. You can enable the automatic answering function and determine how many seconds to wait before the calls get answered automatically. You can also manually route calls to the answering machine when you are too busy to answer them. And you can access messages left on your answering machine directly from your device.

- ! Before using the answering machine, you must record a greeting message.

To record a greeting message for the answering machine

- 1 From your Home screen, tap .
- 2 Find and tap **Settings** > **Call** > **Xperia™ Answering Machine** > **Greetings**.
- 3 Tap **Record new greeting** and follow the on-screen instructions.

To enable automatic answering

- 1 From your Home screen, tap .
 - 2 Find and tap **Settings > Call > Xperia™ Answering Machine**.
 - 3 Drag the slider beside **Answering Machine** to the right.
- 💡 If you don't set a time delay for the automatic answering of calls, the default value is used.



To set a time delay for automatic answering

- 1 From your Home screen, tap .
- 2 Find and tap **Settings > Call > Xperia™ Answering Machine**.
- 3 Tap **Pick up after**.
- 4 Adjust the time by scrolling up and down.
- 5 Tap **Done**.

To forward an incoming call to the answering machine

- When a call comes in, drag **Response options** upwards, then select **Reject with Answering Machine**.
- 💡 When a call comes in, you can also just wait until the preset time delay elapses so that the answering machine picks up the call automatically.

To listen to messages on the answering machine

- 1 From your Home screen, tap .
 - 2 Find and tap **Settings > Call > Xperia™ Answering Machine > Messages**.
 - 3 Select the voice message that you want to listen to.
- 💡 You can also listen to answering machine messages directly from the call log by tapping .

Rejecting a call with a text message

You can reject a call with a text message. When you reject a call with such a message, the message is automatically sent to the caller and stored in the Messaging conversation with the contact.

You can select from a number of predefined messages available on your device, or you can create a new message. You can also create your own personalised messages by editing the predefined ones.

To reject a call with a text message

- 1 When an incoming call arrives, drag **Response options** upwards, then tap **Reject with message**.
- 2 Select a predefined message or tap  and write a new message.

To reject a second call with a text message

- 1 When you hear repeated beeps during a call, drag **Reject with message** upwards.
- 2 Select a predefined message or tap  and write a new message.

To edit the text message used to reject a call

- 1 From your Home screen, tap .
- 2 Find and tap **Settings > Call > Reject call with message**.
- 3 Tap the message that you want to edit, then make the necessary changes.
- 4 Tap **OK**.

Ongoing calls



- 1 Enter numbers during a call
- 2 Toggle sound to a Bluetooth® headset
- 3 Mute the microphone during a call
- 4 Put the current call on hold or retrieve a call on hold
- 5 Make a second call
- 6 End a call

! Your device does not have an ear speaker. Use the loudspeaker or connect a headset during a call.

To change the volume during a call

- Press the volume key up or down.



To activate the screen during a call

- Briefly press .

Using the call log

In the call log, you can view missed calls , received calls  and dialled calls .

To open the call log

- 1 From your Home screen, tap .
- 2 Find and tap .
- 3 If the call log does not appear, tap .

To view your missed calls

- 1 When you have missed a call,  appears in the status bar. Drag the status bar downwards.
- 2 Tap **Missed call**.

To call a number from your call log

- Tap the number.

💡 To edit the number before calling, touch and hold the number in the call log, then tap **Edit number before call**.

To add a number from the call log to your contacts

- 1 Touch and hold a number displayed in the call log, then tap **Add to Contacts**.
- 2 Select an existing contact to which you want to add the number, or tap **Create new contact**.
- 3 Edit the contact details, then tap **SAVE**.

To view call log options

- When the call log is open, tap .
- 💡 You can also access general call settings using the instruction above.

Forwarding calls

You can direct calls to a different recipient, for example, to another phone number, another device, or an answering service.

To forward calls

- 1 From your Home screen, tap .
- 2 Find and tap **Settings** > **Call**.
- 3 Tap **Call forwarding** and select an option.
- 4 Enter the number to which you want to forward calls, then tap **Enable**.

To turn off call forwarding

- 1 From your Home screen, tap .
- 2 Find and tap **Settings** > **Call** > **Call forwarding**.
- 3 Select an option, then tap **Disable**.

Restricting calls

You can block all or certain categories of incoming and outgoing calls. If you have received a PIN2 code from your service provider, you can also use a list of Fixed Dialling Numbers (FDNs) to restrict outgoing calls. If your subscription includes a voicemail service, you can send all incoming calls from a specific contact directly to voicemail. If you want to block a certain number, you can go to Google Play™ and download applications that support this function.

- 💡 FDN is not supported by all network operators. Contact your network operator to verify if your SIM card or network service supports this feature.

To block incoming or outgoing calls

- 1 From your Home screen, tap .
 - 2 Find and tap **Settings** > **Call**.
 - 3 Tap **Call Barring**, then select an option.
 - 4 Enter the password and tap **Enable**.
- ! When you set up call blocking for the first time, you need to enter a password to activate the call blocking function. You must use this same password later if you want to edit call blocking settings.

To enable or disable fixed dialling

- 1 From your Home screen, tap .
- 2 Find and tap **Settings** > **Call** > **Fixed dialling numbers**.
- 3 Tap **Activate fixed dialling** or **Deactivate fixed dialling**.
- 4 Enter your PIN2 and tap **OK**.





To access the list of accepted call recipients

- 1 From your Home screen, tap .
- 2 Find and tap **Settings** > **Call** > **Fixed dialling numbers** > **Fixed dialling numbers**.

To change the SIM card PIN2

- 1 From the Home screen, tap .
- 2 Find and tap **Settings** > **Call**.
- 3 Tap **Fixed dialling numbers** > **Change PIN2**.
- 4 Enter the old SIM card PIN2 and tap **OK**.
- 5 Enter the new SIM card PIN2 and tap **OK**.
- 6 Confirm the new PIN2 and tap **OK**.

To send incoming calls from a specific contact directly to voicemail

- 1 From your Home screen, tap .
- 2 Find and tap .
- 3 Select the contact for which you want to direct all incoming calls automatically to voicemail.
- 4 Tap  > .
- 5 Mark the checkbox beside All calls to voicemail.
- 6 Tap SAVE.

Multiple calls

If you have activated call waiting, you can handle multiple calls at the same time. When it is activated, you will be notified by a beep if you receive another call.

To activate or deactivate call waiting

- 1 From your Home screen, tap .
- 2 Find and tap **Settings** > **Call** > **Additional settings**.
- 3 To activate or deactivate call waiting, tap **Call waiting**.



To answer a second call and put the ongoing call on hold

- When you hear repeated beeps during a call, drag  to the right.

To reject a second call

- When you hear repeated beeps during a call, drag  to the left.

To make a second call

- 1 During an ongoing call, tap . The call log is displayed.
- 2 Tap  to display the dialpad.
- 3 Enter the number of the recipient and tap . The first call is put on hold.

To answer a third call and end the ongoing call

- When the third call comes in, tap **End current call and answer**.

To reject a third call

- When the third call comes in, tap **Decline incoming call**.

To switch between multiple calls





- To switch to another call and put the current call on hold, tap **Switch to this call**.

Conference calls

With a conference or multiparty call, you can have a joint conversation with two or more persons.

- ! For details about the number of participants that you can add to a conference call, contact your network operator.

To make a conference call

- 1 During an ongoing call, tap . The call log appears.
- 2 To display the dialpad, tap .
- 3 Dial the number of the second participant and tap . The first participant is put on hold temporarily.
- 4 To add the second participant to the call and start the conference, tap .
- 5 To add more participants to the call, repeat the relevant steps as described above.

To have a private conversation with a conference call participant

- 1 During an ongoing conference call, tap **Manage conference**.
- 2 Tap the telephone number of the participant with whom you want to have a private conversation.
- 3 To end the private conversation and return to the conference call, tap .

To release a participant from a conference call

- 1 During an ongoing conference call, tap **Manage conference**.
- 2 Tap  next to the participant you want to release.

To end a conference call

- During the call, tap .

Voicemail

If your subscription includes a voicemail service, callers can leave voice messages for you when you can't answer calls. Your voicemail service number is normally saved on your SIM card. If not, you can get the number from your service provider and enter it manually.

To enter your voicemail number

- 1 From the Home screen, tap .
- 2 Find and tap **Settings** > **Call** > **Voicemail** > **Voicemail settings** > **Voicemail number**.
- 3 Enter your voicemail number.
- 4 Tap **OK**.



To call your voicemail service

- 1 Open the dialpad.
 - 2 Touch and hold **1** until your voicemail number is dialed.
-  The first time you call your voicemail number, your network operator's voicemail system normally prompts you to set up your voicemail. For example, you may be asked to record a greeting and set a password.

Emergency calls

Your device supports international emergency numbers, for example, 112 or 911. You can normally use these numbers to make emergency calls in any country, with or without a SIM card inserted if you are within range of a network.





To make an emergency call

- 1 Open the dialpad.
 - 2 Enter the emergency number, then tap .
-  You can make emergency calls even when no SIM card is inserted or when all outgoing calls are blocked.

To make an emergency call while the SIM card is locked

- 1 Tap **Emergency call**.
- 2 Enter the emergency number and tap .

To make an emergency call while the device is locked

- 1 To activate the screen, briefly press the power key .
- 2 Touch and hold the phone icon , then drag it to the right. The call log is displayed.
- 3 Tap  to display the dialpad.
- 4 Enter the emergency number and tap .

Contacts

Transferring contacts

There are several ways to transfer contacts to your new device. You can sync contacts from an online account or import contacts directly from another device.

Transferring contacts using a computer

Xperia™ Transfer is an application that helps you to collect contacts from your old device and transfer them to your new device. Xperia™ Transfer, which you can access from within the PC Companion and the Sony Bridge for Mac computer programs, supports mobile devices that run on several operating systems, including iOS, Android™, Windows® and BlackBerry™.

To use Xperia™ Transfer, you need:

- An Internet-connected computer.
- A USB cable for your old device.
- A USB cable for your new Android™ device.
- Your old device.
- Your new Android™ device.





To transfer contacts to your new device

- 1 Search and download PC Companion (on a PC) or Bridge for Mac (on a Mac computer) from www.sonymobile.com if the application is not already installed.
- 2 After successful installation, open the PC Companion application or the Sony Bridge for Mac application, then click *Xperia™ Transfer* and follow the relevant instructions to transfer your contacts.

Transferring contacts using an online account

If you sync the contacts in your old device or your computer with an online account, for example, Google Sync™, Facebook™ or Microsoft® Exchange ActiveSync®, you can transfer your contacts to your new device using that account.



To synchronise contacts to your new device using a synchronisation account

- 1 From your Home screen, tap , then tap .
 - 2 Tap , then tap **Settings > Accounts & sync**.
 - 3 Select the account that you want to sync your contacts with, then tap  > **Sync now**.
- ! You need to be signed in to the relevant sync account before you can sync your contacts with it.

Other methods for transferring contacts

There are several other ways to transfer contacts from your old device to your new device. For example, you can copy contacts to a memory card, use Bluetooth® technology, or save contacts to a SIM card. For more specific information about transferring the contacts from your old device, refer to the relevant User guide.



To import contacts from a memory card

- 1 From your Home screen, tap , then tap .
- 2 Press , then tap **Import contacts > SD card**.
- 3 Select the files that you want to import and tap **OK**.

To import contacts using Bluetooth® technology

- 1 Make sure you have the Bluetooth® function turned on and that your device is set to visible.
- 2 When you are notified of an incoming file to your device, drag the status bar downwards and tap the notification to accept the file transfer.
- 3 Tap **Accept** to start the file transfer.
- 4 Drag the status bar downwards. When the transfer is complete, tap the notification.
- 5 Tap the received file.

To import contacts from a SIM card



- ! You may lose information or get multiple contact entries if you transfer contacts using a SIM card.
- 1 From your Home screen, tap , then tap .
 - 2 Tap , then tap **Import contacts** > **SIM card**.
 - 3 To import an individual contact, find and tap the contact. To import all contacts, tap **Import all**.

Searching and viewing contacts





- 1 Contacts, Favourites and Groups tabs
- 2 Search for contacts
- 3 View more options
- 4 View contact details
- 5 Jump to contacts starting with the selected letter
- 6 Add a contact

To search for a contact



- 1 From your Home screen, tap , then tap .
- 2 Tap  and enter a phone number, name or other information in the **Search contacts** field. The result list is filtered as you enter each character.

To select which contacts to display in the Contacts application



- 1 From your Home screen, tap , then tap .
- 2 Press , then tap **Filter**.
- 3 In the list that appears, mark or unmark the desired options. If you have synchronised your contacts with a synchronisation account, that account appears in the list. To further expand the list of options, tap the account.

Adding and editing contacts





To add a contact

- 1 From your Home screen, tap , then tap .
 - 2 Tap .
 - 3 If you have synchronised your contacts with one or more accounts and you are adding a contact for the first time, you must select the account to which you want to add this contact. Alternatively, tap **No backup** if you only want to use and save this contact on your device.
 - 4 Enter or select the desired information for the contact.
 - 5 When you are finished, tap **Done**.
- ! After you select a synchronisation account in step 3, that account will show as the default account offered the next time you add a contact. When you save a contact to a particular account, that account will show as the default account to save to the next time you add a contact. If you have saved a contact to a particular account and want to change it, you need to create a new contact and select a different account to save it to.
- 💡 If you add a plus sign and the country code before a contact's phone number, you do not have to edit the number again when you make calls from other countries.



To edit a contact

- 1 From your Home screen, tap , then tap .
 - 2 Tap the contact that you want to edit, then tap .
 - 3 Edit the desired information.
 - 4 When you are finished, tap **Done**.
- ! Some synchronisation services do not allow you to edit contact details.



To associate a picture with a contact

- 1 From your Home screen, tap , then tap .
 - 2 Tap the contact that you want to edit, then tap .
 - 3 Tap , and select a method for adding the contact picture.
 - 4 After you add the picture, tap **Done**.
- 💡 You can also add a picture to a contact directly from the **Album** application. If you want to add a picture that is saved to an online account, you must download the picture first.



To delete contacts

- 1 From your Home screen, tap , then tap .
- 2 Touch and hold the contact that you want to delete.
- 3 To delete all contacts, tap the downwards arrow to open the drop down menu, then select **Mark all**.
- 4 Tap , then tap **Delete**.

To edit contact information about yourself

- 1 From your Home screen, tap , then tap .
- 2 Tap **Myself**, then tap .
- 3 Enter the new information or make the changes you want.
- 4 When you are done, tap **Done**.



To create a new contact from a text message

- 1 From your Home screen, tap , then find and tap .
- 2 Tap  > **Save**.
- 3 Select an existing contact, or tap **Create new contact**.
- 4 Edit the contact information and tap **Done**.



Favourites and groups

You can mark contacts as favourites so that you can get quick access to them from the Contacts application. You can also assign contacts to groups, to get quicker access to a group of contacts from within the Contacts application.

To mark or unmark a contact as a favourite

- 1 From the Home screen, tap , then tap .
- 2 Tap the contact you want to add to or remove from your favourites.
- 3 Tap .

To view your favourite contacts



- 1 From your Home screen, tap , then tap .
- 2 Tap **Favorites**.

To assign a contact to a group



- 1 In the Contacts application, tap the contact that you want to assign to a group.
- 2 Tap , then tap the bar directly under **Groups**.
- 3 Mark the checkboxes for the groups to which you want to add the contact.
- 4 Tap **Done**.

Sending contact information





To send your business card

- 1 From your Home screen, tap , then tap .
- 2 Tap **Myself**.
- 3 Tap , then tap **Share**.
- 4 Select an available transfer method and follow the on-screen instructions.

To send a contact

- 1 From your Home screen, tap , then tap .
- 2 Tap the contact whose details you want to send.
- 3 Tap , then tap **Share**.
- 4 Select an available transfer method and follow the on-screen instructions.



To send several contacts at once

- 1 From your Home screen, tap , then tap .
- 2 Press , then tap **Mark several**.
- 3 Mark the contacts you want to send, or select all if you want to send all contacts.
- 4 Tap , then select an available transfer method and follow the on-screen instructions.



Avoiding duplicate entries in the Contacts application

If you synchronise your contacts with a new account or import contact information in other ways, you could end up with duplicate entries in the Contacts application. If this happens, you can join such duplicates to create a single entry. And if you join entries by mistake, you can separate them again later.

To link contacts

- 1 From your Home screen, tap , then tap .
- 2 Tap the contact that you want to link with another contact.
- 3 Press , then tap **Link contact**.
- 4 Tap the contact whose information you want to join with the first contact, then tap **OK** to confirm. The information from the first contact is merged with the second contact, and the linked contacts are displayed as one contact in the Contacts list.

To separate linked contacts

- 1 From your Home screen, tap , then tap .
- 2 Tap the linked contact that you want to edit, then tap .
- 3 Tap **Unlink contact** > **Unlink**.





Backing up contacts

You can use a memory card, a SIM card or a USB storage device to back up contacts. See *Transferring contacts* on page 64 for more information about how to restore contacts to your device.

To export all contacts to a memory card

- 1 From your Home screen, tap , then tap .
- 2 Press , then tap **Export contacts** > **SD card..**
- 3 Tap **OK**.

To export contacts to a SIM card

-  When you export contacts to a SIM card, not all information may get exported. This is due to memory limitations on SIM cards.
- 1 From your Home screen, tap , then tap .
 - 2 Press , then tap **Export contacts** > **SIM card**.
 - 3 Mark the contacts you want to export, or tap **Mark all** if you want to export all your contacts.
 - 4 Tap **Export**.
 - 5 Select **Add contacts** if you want to add the contacts to existing contacts on your SIM card, or select **Replace all contacts** if you want to replace the existing contacts on your SIM card.

To export all contacts to a USB storage device

-  When you export contacts using this method, you must first connect your device to a USB storage device, for example, a flash drive or an external hard drive, using a USB Host adapter cable. See *Connecting your device to USB accessories* on page 109 for more information about how to connect your device to a USB storage device.
- 1 From your Home screen, tap , then tap .
 - 2 Tap , then tap **Export contacts** > **USB storage**.
 - 3 Tap **OK**.

Messaging and chat

Reading and sending messages

The Messaging application shows your messages as conversations, which means that all messages to and from a particular person are grouped together. To send multimedia messages, you need the correct MMS settings on your device. See *Internet and MMS settings* on page 29 .

- ! The number of characters that you can send in a single message varies depending on the operator and the language you use. The maximum size of a multimedia message, which includes the size of added media files, is also operator dependent. Contact your network operator for more information.

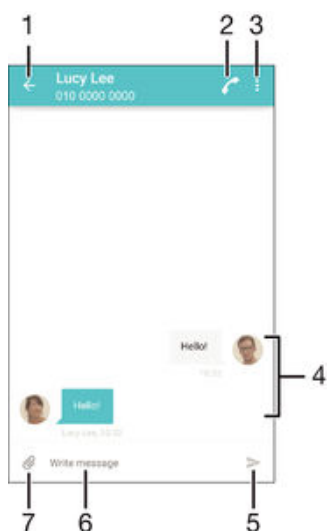

1 Go back to the list of conversations

2 Call the message sender

3 View more options

4 Sent and received messages

5 Send a completed message



6 Text entry field

7 Add attachments

To create and send a message



- 1 From your Home screen, tap , then find and tap .
 - 2 Tap .
 - 3 Enter the recipient's name or phone number, or other contact information that you have saved about the recipient, then select from the list that appears. If the recipient is not listed as a contact, enter the recipient's number manually.
 - 4 If you want to send a group message, repeat the procedure described above to add more recipients.
 - 5 Tap **Write message** and enter your message text.
 - 6 If you want to add an attachment, tap and select an option.
 - 7 To send the message, tap .
- 💡 If you exit a message before sending, it gets saved as a draft. The conversation gets tagged with the word **Draft**.

To read a received message



- 1 From your Home screen, tap , then find and tap .
- 2 Tap the desired conversation.
- 3 If the message is not yet downloaded, tap and hold the message, then tap **Download message**.

 All received messages are saved by default to the device memory.



To reply to a message

- 1 From your Home screen, tap , then find and tap .
- 2 Tap the conversation containing the message.
- 3 Enter your reply and tap .

To forward a message



- 1 From your Home screen, tap , then find and tap .
- 2 Tap the conversation containing the message that you want to forward.
- 3 Touch and hold the message that you want to forward, then tap **Forward message**.
- 4 Enter the recipient's name or phone number, or other contact information that you have saved about the recipient, then select from the list that appears. If the recipient is not listed as a contact, enter the recipient's number manually.
- 5 Edit the message, if necessary, then tap .

To save a file contained in a message you receive





- 1 From your Home screen, tap , then find and tap .
- 2 Tap the conversation you want to open.
- 3 If the message has not been downloaded yet, tap and hold the message, then tap **Download message**.
- 4 Touch and hold the file you want to save, then select the desired option.

Organising your messages



To delete a message

- 1 From your Home screen, tap , then find and tap .
- 2 Tap the conversation containing the message you want to delete.
- 3 Touch and hold the message you want to delete, then tap **Delete message** > **Delete**.



To delete conversations

- 1 From your Home screen, tap , then find and tap .
- 2 Tap , then tap **Delete conversations**.
- 3 Mark the checkboxes for the conversations that you want to delete, then tap  > **Delete**.



To star a message

- 1 From your Home screen, tap , then find and tap .
- 2 Tap the conversation that you want to open.
- 3 Touch and hold the message that you want to star, then tap **Add star**.
- 4 To unstar a message, touch and hold the starred message, then tap **Delete star**.

To view starred messages





- 1 From your Home screen, tap , then find and tap .
- 2 Tap , then tap **Starred messages**.
- 3 All starred messages appear in a list.

To search for messages



- 1 From your Home screen, tap , then find and tap .
- 2 Tap , then tap **Search**.
- 3 Enter your search keywords. The search results appear in a list.

Calling from a message

To call a message sender





- 1 From your Home screen, tap , then find and tap .
- 2 Tap a conversation and tap , then tap .

To save a sender's number as a contact

- 1 From your Home screen, tap , then find and tap .
- 2 Tap  > **Save**.
- 3 Select an existing contact, or tap **Create new contact**.
- 4 Edit the contact information and tap **Save**.

Messaging settings

To change your message notification settings

- 1 From your Home screen, tap , then find and tap .
- 2 Tap , then tap **Settings**.
- 3 To set a notification sound, tap **Notification sound**, then select an option or tap  and select a music file that is saved to your device.
- 4 To confirm, tap **Done**.
- 5 For other notification settings, drag the relevant sliders to the right or left.

To turn the delivery report function on or off for outgoing messages

- 1 From your Home screen, tap , then find and tap .
- 2 Tap , then tap **Settings**.
- 3 Drag the slider beside **Delivery report** to the right or left.

- ! After the delivery report function is turned on, a check mark is displayed in messages that have been successfully delivered.

Instant messaging and video chat

You can use the Google Hangouts™ instant messaging and video chat application on your device to chat with friends who also use the application on computers, Android™ devices and other devices. You can turn any conversation into a video call with several friends, and you can send messages to friends even when they are offline. You can also view and share photos easily.

Hangouts™ requires Internet access and a Google™ account. Go to <http://support.google.com/hangouts> and click the "Hangouts on your Android" link to get more detailed information about how to use this application.

- ! The video call function only works on devices with a front camera.

To use the Hangouts™ application

- 1 From your Home screen, tap .
- 2 Find and tap **Hangouts**.

Email



Setting up email

Use the email application in your device to send and receive email messages through your email accounts. You can have one or several email accounts at the same time, including corporate Microsoft Exchange ActiveSync accounts.

To set up an email account

- 1 From your Home screen, tap .
 - 2 Find and tap **Email**.
 - 3 Follow the instructions that appear on the screen to complete the setup.
- 💡 For some email services, you may need to contact your email service provider for information on detailed settings for the email account.

To add an extra email account

- 1 From your Home screen, tap .
- 2 Find and tap **Email**.
- 3 Tap , then tap **Settings > Add account**.
- 4 Enter the email address and password, then tap **Next**. If the settings for the email account cannot be downloaded automatically, complete the setup manually.
- 5 When you are finished, tap **Next**.

Sending and receiving email messages

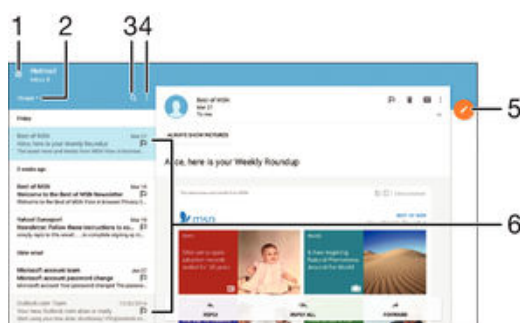

- 1 View a list of all email accounts and recent folders
- 2 Sort email messages
- 3 Search for email messages
- 4 Access settings and options
- 5 Write an email message
- 6 List of email messages



To download new email messages

- When the email inbox is open, swipe downwards on the message list.
- ! Before trying to download new email messages, make sure that you have a working data connection. For more information about ensuring successful data connections, see *Internet and MMS settings* on page 29 .

To read your email messages

- 1 From your Home screen, tap .
- 2 Find and tap **Email**.
- 3 If you are using several email accounts, drag the left edge of the screen to the right and select the account that you want to check. If you want to check all your email accounts at once, drag the left edge of the screen to the right, then tap **Combined inbox**.
- 4 In the email inbox, scroll up or down and tap the email message that you want to read.

To create and send an email message

- 1 From your Home screen, tap , then find and tap **Email**.
- 2 If you are using several email accounts, drag the left edge of the screen to the right and select the account from which you want to send the email.
- 3 Tap , then type the recipient's name or email address and select one or more recipients from the drop down list.
- 4 Enter the email subject and message text, then tap .

To reply to an email message

- 1 In your email inbox, find and tap the message that you want to reply to, then tap **Reply** or **Reply all**.
- 2 Enter your reply, then tap .

To forward an email message

- 1 In your email inbox, find and tap the message that you want to forward, then tap **Forward**.
- 2 Enter the recipient's name or email address, then select one or more recipients from the drop down list.
- 3 Enter your message text, then tap .

To view an email message attachment



- 1 Find and tap the email message containing the attachment that you want to view. Email messages with attachments are indicated by .
- 2 After the email message opens, tap **Load**. The attachment starts to download.
- 3 After the attachment finishes downloading, tap **View**.

To save a sender's email address to your contacts

- 1 Find and tap a message in your email inbox.
- 2 Tap the name of the sender, then tap **OK**.
- 3 Select an existing contact, or tap **Create new contact**.
- 4 Edit the contact information, if desired, then tap **Done**.

Organising your email messages

To sort your emails

- 1 From your Home screen, tap .
- 2 Find and tap **Email**.
- 3 If you are using several email accounts, drag the left edge of the screen to the right and select the account containing the email that you want to sort. If you want to sort email in all your email accounts at once, drag the left edge of the screen to the right, then tap **Combined inbox**.
- 4 Tap , then select a sorting option.

To search for emails

- 1 From your Home screen, tap , then find and tap **Email**.
- 2 If you are using several email accounts, drag the left edge of the screen to the right and select the account that you want to search. If you want to search all your email accounts at once, drag the left edge of the screen to the right, then tap **Combined inbox**.
- 3 Tap **Q**.
- 4 Enter your search text, then tap **Q** on the keyboard.
- 5 The search result appears in a list sorted by date. Tap the email message that you want to open.

To view all folders for one email account

- 1 From your Home screen, tap , then find and tap **Email**.
- 2 Drag the left edge of the screen to the right, then select the account that you want to check.
- 3 Under the account that you want to check, select **Show all folders**.

To delete an email message



- In your email inbox, flick the message that you want to delete to the right.

To move an email message to another folder



- 1 In your email inbox, flick the message that you want to move to the left.
- 2 Tap **Move**, then select a folder.

Email account settings



To remove an email account from your device

- 1 From your Home screen, tap .
- 2 Find and tap **Email**.
- 3 Press , then tap **Settings**.
- 4 Select the account you want to remove.
- 5 Tap **Delete account** > **OK**.

To change the inbox check frequency

- 1 From your Home screen, tap .
- 2 Find and tap **Email**.
- 3 Tap , then tap **Settings**.
- 4 Select the account for which you want to change the inbox check frequency.
- 5 Tap **Check frequency** > **Check frequency** and select an option.

To set an Out of Office auto-reply in an Exchange Active Sync account

- 1 From your Home screen, tap .
- 2 Press , then tap **Settings**.
- 3 Select the EAS (Exchange Active Sync) account for which you want to set an Out of Office auto-reply.
- 4 Tap **Out of office**.
- 5 Drag the slider beside **Out of office** to the right to turn on the function.
- 6 If needed, mark the **Set time range** checkbox and set the time range for the auto reply.
- 7 Enter your Out of Office message in the body text field.
- 8 Tap **OK** to confirm.

Gmail™

If you have a Google™ account, you can use the Gmail™ application to read and write email messages.



- 1 View a list of all Gmail accounts and folders
- 2 Search for email messages
- 3 Archive an email message
- 4 Delete an email message
- 5 Mark an email message as unread
- 6 Move an email message to a folder
- 7 Access settings and options
- 8 List of email messages
- 9 Write an email message

To learn more about Gmail™

- When the Gmail application is open, drag the left edge of the screen to the right, then find and tap **Help**.

Music

Transferring music to your device

There are different ways to transfer music from a computer to your device:

- Connect the device and computer using a USB cable and then drag and drop the music files directly into the file manager application on the computer. See *Managing files using a computer* on page 132 .
 - If the computer is a PC, you can use the Media Go™ application from Sony and organise your music files, create playlists, subscribe to podcasts, and more. To learn more and download the Media Go™ application, go to <http://mediago.sony.com/enu/features>.
 - If the computer is an Apple® Mac®, you can use the Sony Bridge for Mac application to transfer your media files from iTunes to your device. To learn more and download Sony Bridge for Mac, go to www.sonymobile.com/global-en/tools/bridge-for-mac/.
- ! The Music may not support all music file formats. For more information about supported file formats and the use of multimedia (audio, image and video) files, download the White Paper for your device at www.sonymobile.com/support.

Listening to music

Use the Music application to listen to your favourite music and audio books.

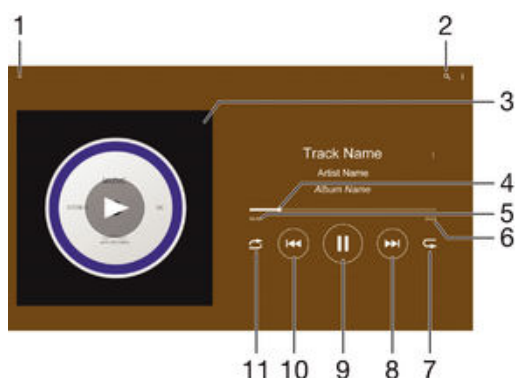



- 1 Go to the Music home screen
- 2 Search all songs saved to your device
- 3 Album art (if available)
- 4 Progress indicator – Drag the indicator or tap along the line to fast forward or rewind
- 5 Elapsed time of current song
- 6 Total time length of current song
- 7 Repeat all songs in the current play queue
- 8 Tap to go to the next song in the play queue
Touch and hold to fast forward within the current song
- 9 Play or pause a song
- 10 Tap to go to the previous song in the play queue
Touch and hold to rewind within the current song
- 11 Shuffle songs in the current play queue

Music home screen



- 1 Drag the left edge of the screen to the right to open the Music home screen menu
- 2 Scroll up or down to view content
- 3 Play a song using the Music application
- 4 Return to the music player screen

To play a song using the Music application

- 1 From your Home screen, tap , then find and tap .
- 2 Drag the left edge of the screen to the right.
- 3 Select a music category.
- 4 Tap a song to play it.

! You might not be able to play copyright-protected items. Verify that you have necessary rights in material that you intend to share.

To find song-related information online

- While a song is playing in the Music application, tap the Album art and then tap **More about this**.
- 💡 Online resources related to the song can include videos on YouTube™, song lyrics, and artist information on Wikipedia.

To edit music information

- 1 From the Music application, tap the Album art and then tap **Edit music info**.
- 2 Edit the information as desired.
- 3 When you are finished, tap **Save**.

To adjust the audio volume

- Press the volume key.

To minimise the Music application

- When a song is playing, tap  to go to the Home screen. The Music application stays playing in the background.

To open the Music application when it is playing in the background

- 1 While a song is playing in the background, tap the  to open the recently used applications window.
- 2 Tap the Music application.

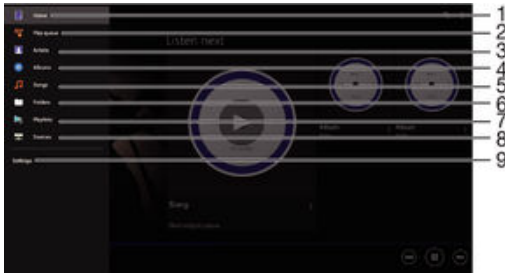

Music home screen menu

The Music home screen menu gives you an overview of all the songs on your device. From here you can manage your albums and playlists, and you can organise your music by mood and tempo using SensMe™ channels.



- 1 Return to the Music home screen
- 2 View the current play queue
- 3 Browse all artists
- 4 Browse all albums
- 5 Browse all songs
- 6 Browse your music library and filter by artist, album or song name
- 7 Browse all playlists
- 8 Play a shared music file on another device
- 9 Open the settings menu for the Music application

To open the Music home screen menu

- 1 From your Home screen, tap , then find and tap .
- 2 Drag the left edge of the screen to the right.

To return to the Music home screen



- When the Music home screen menu is open, tap **Home**.
- When the Music home screen menu is open, tap on the screen to the right of the menu.

To update your music with the latest information

- 1 From the Music home screen, tap .
- 2 Tap **Download music info** > **Start**. Your device searches online and downloads the latest available album art and song information for your music.

-  The SensMe™ channels application is activated when you download music information.

To enable the SensMe™ channels application

- From the Music home screen, tap , then tap **Download music info** > **Start**.
-  This application requires a Wi-Fi® network connection.

To delete a song

- 1 From the Music home screen menu, browse to the song that you want to delete.
- 2 Touch and hold the song title, then tap **Delete** in the list that appears.
- 3 Tap **Delete** again to confirm.

Playlists

On the Music home screen, you can create your own playlists from the music that is saved on your device.

To create your own playlists

- 1 From the Music home screen, touch and hold the name of the album or song that you want to add to a playlist.
 - 2 In the menu that opens, tap **Add to playlist** > **Create new playlist**.
 - 3 Enter a name for the playlist and tap **OK**.
- 💡 You can also tap **Add to playlist** to create a new playlist.

To play your own playlists

- 1 Open the Music home screen menu, then tap **Playlists**.
- 2 Under **Playlists**, select the playlist that you want to open.
- 3 If you want to play all songs, tap **Shuffle all**.

To add songs to a playlist

- 1 From the Music home screen, browse to the song or album that you want to add to a playlist.
- 2 Touch and hold the song or the album title, then tap **Add to playlist**.
- 3 Tap the name of the playlist to which you want to add the album or song. The album or song is now added to the playlist.

To remove a song from a playlist

- 1 In a playlist, touch and hold the title of the song that you want to delete.
 - 2 Tap **Delete from playlist**.
- ! You might not be able to delete a song that is saved on the memory card or on your device's internal storage.

To delete a playlist

- 1 Open the Music home screen menu, then tap **Playlists**.
 - 2 Touch and hold the playlist that you want to delete.
 - 3 Tap **Delete**.
 - 4 Tap **Delete** again to confirm.
- ! You cannot delete smart playlists.

Sharing music

To share a song

- 1 From the Music home screen, browse to the song or album that you want to share.
 - 2 Touch and hold the song title, then tap **Share**.
 - 3 Select an application from the list, then follow the on-screen instructions.
- 💡 You can also share albums and playlists in the same way.

Enhancing the sound

To improve the sound quality using the Equaliser

- 1 Open the Music home screen menu, then tap **Settings** > **Sound effects** > **Sound effects** > **Equalizer**.
- 2 To adjust the sound manually, drag the frequency band buttons up or down. To adjust the sound automatically, tap ✓ and select a style.



To turn on the Surround sound feature

- 1 Open the Music home screen menu, then tap **Settings** > **Sound effects** > **Sound effects** > **Surround sound (VPT)**.
- 2 Flick left or right to select a setting, then tap **OK** to confirm.



Visualiser

The Visualiser adds visual effects to your songs as you play them. The effects for each song are based on the characteristics of the music. They change, for example, in response to changes in the music's loudness, rhythm and frequency level. You can also change the background theme.

To turn on the Visualiser

- 1 In the Music application, tap .
 - 2 Tap **Visualizer**.
-  Tap the screen to switch to full screen view.

To change the background theme

- 1 In the Music application, tap , then tap **Visualizer**.
- 2 Tap the screen to display the controls.
- 3 Tap  > **Theme**, then select a theme.

Recognising music with TrackID™

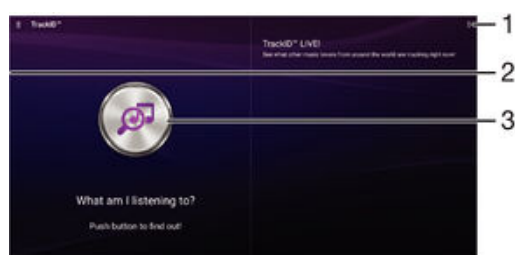

Use the TrackID™ music recognition service to identify a song you hear playing in your surroundings. Just record a short sample of the song and you'll get artist, title and album info within seconds. You can purchase song identified by TrackID™ and you can view TrackID™ charts to see what TrackID™ users around the globe are searching for. For best results, use TrackID™ in a quiet area.



- 1 View TrackID™ options
- 2 Drag the left edge of the screen to the right to open the TrackID™ home screen menu
- 3 Identify the music that you are listening to

-  The TrackID™ application and the TrackID™ service are not supported in all countries/regions or by all networks and/or service providers in all areas.

To identify music using TrackID™ technology

- 1 From your Home screen, tap .
- 2 Find and tap **TrackID™**, then hold your device close to the music source.
- 3 Tap . If the song is recognised by the TrackID™ service, the results appear on the screen.

-  To return to the **TrackID™** start screen, tap .

To view artist information for a song

- After a song has been recognised by the **TrackID™** application, tap **Artist info**.

TrackID™ home screen menu

The TrackID™ home screen menu gives you an overview of all the songs that you have recorded and identified using the TrackID™ service. From here you can also view your songs based on current music charts and search history.

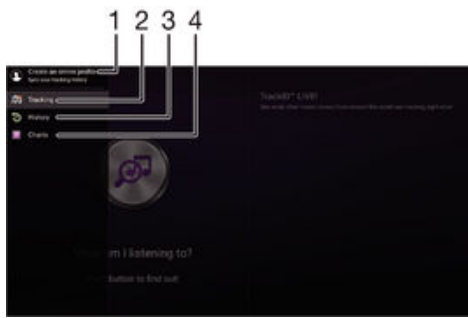

- 1 Create an online TrackID™ profile
- 2 Open the TrackID™ application
- 3 View the search result history
- 4 View current music charts

To delete song from the track history

- 1 Open the **TrackID™** application, then tap **History**.
- 2 Touch and hold the name of the song that you want to delete, then tap **Delete**.

FM radio

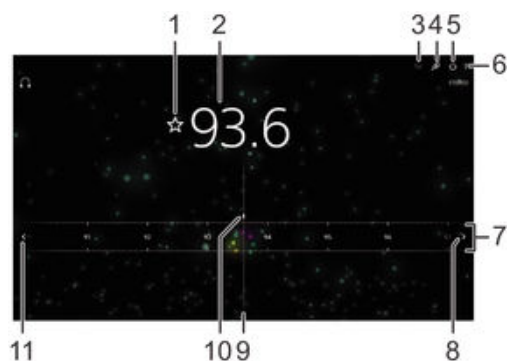

Listening to the radio

The FM radio in your device works like any FM radio. For example, you can browse and listen to FM radio stations and save them as favourites. You must connect a wired headset or headphones to your device before you can use the radio. This is because the headset or headphones act as an antenna. After one of these devices is connected, you can then switch the audio to the speaker, if desired.



- 1 Save or remove a channel as a favourite
- 2 Tuned frequency
- 3 Favourites list
- 4 Launch the TrackID™ music recognition application
- 5 Radio on/off button
- 6 View menu options
- 7 Frequency band – drag left or right to move between channels
- 8 Move up the frequency band to search for a channel
- 9 Tuning dial
- 10 A saved favourite channel
- 11 Move down the frequency band to search for a channel

To listen to the FM radio

- 1 Connect a headset or a set of headphones to your device.
- 2 From your Home screen, tap .
- 3 Find and tap **FM radio** . The available channels appear as you scroll through the frequency band.

- ! When you start the FM radio, available channels appear automatically. If a channel has RDS information, it appears a few seconds after you start listening to the channel.



To move between radio channels

- Drag the frequency band left or right.



To start a new search for radio channels

- 1 When the radio is open, press .
- 2 Tap **Search for channels**. The radio scans the whole frequency band, and all available channels are displayed.

To switch the radio sound to the speaker

- 1 When the radio is open, press .
 - 2 Tap **Play in speaker**.
-  To switch the sound back to the wired headset or headphones, press  and tap **Play in headphones**.

To identify a song on the FM radio using TrackID™

- 1 While the song is playing on your device's FM radio, tap , then select **TrackID™**.
 - 2 A progress indicator appears while the TrackID™ application samples the song. If identification is successful, you are presented with a result or a list of possible results.
 - 3 To return to the FM Radio, tap .
-  The TrackID™ application and the TrackID™ service are not supported in all countries/regions, or by all networks and/or service providers in all areas.

Favourite radio channels

To save a channel as a favourite

- 1 When the radio is open, navigate to the channel that you want to save as a favourite.
- 2 Tap .
- 3 Enter a name and select a colour for the channel, then press **Save**.

To listen to a favourite radio channel



- 1 Tap .
- 2 Select an option.

To remove a channel as a favourite

- 1 When the radio is open, navigate to the channel that you want to remove.
- 2 Tap , then tap **Delete**.

Sound settings

To switch between mono and stereo sound mode

- 1 When the radio is open, press .
- 2 Tap **Enable stereo sound**.
- 3 To listen to the radio in mono sound mode again, press  and tap **Force mono sound**.

To select the radio region

- 1 When the radio is open, press .
- 2 Tap **Set radio region**.
- 3 Select an option.

To adjust the Visualiser

- 1 When the radio is open, tap .
- 2 Tap **Visualizer**.
- 3 Select an option.

Camera

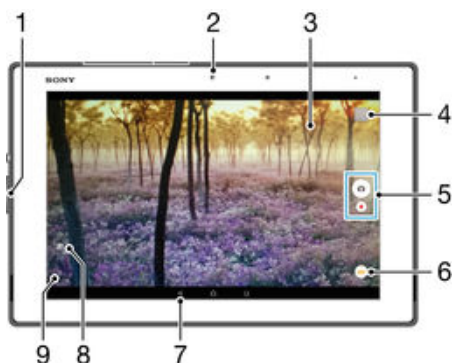

Taking photos and recording videos





- 1 Zoom in or out
- 2 Front camera
- 3 Main camera screen
- 4 View photos and videos
- 5 Take photos or record video clips
- 6 Adjust capturing mode settings
- 7 Go back a step or exit the camera
- 8 Switch between front and main camera
- 9 Display all settings

💡 When you are recording video continuously, the device may get warm. This is normal because the video camera function consumes more power and memory. Also, a notification may appear to inform you that the camera is going to turn off temporarily in order to cool down. In such cases you must wait a while until the camera is ready again to shoot video.

To take a photo from the lock screen

- 1 To activate the screen, briefly press the power key (⏻).
- 2 To activate the camera, touch and hold the camera icon , then drag it to the left.
- 3 After the camera opens, tap .



To take a photo by touching the screen

- 1 Activate the camera.
- 2 Tap , then tap .
- 3 Drag the slider beside **Touch capture** to the right.
- 4 Point the camera towards the subject.
- 5 To activate auto focus, touch and hold an area on the screen. When the focus frame turns blue, lift your finger to take the photo.

To take a photo by tapping the on-screen camera button

- 1 Activate the camera.
- 2 Point the camera towards the subject.
- 3 Tap the on-screen camera button . The photo is taken as soon as you release your finger.





To take a self-portrait using the front camera

- 1 Activate the camera.
- 2 Tap .
- 3 To take the photo, tap the on-screen camera button . The photo is taken as soon as you release your finger.

To use the zoom function

- When the camera is open, press the volume key up or down.
- When the camera is open, pinch in or pinch out on the camera screen.

To record a video

- 1 Activate the camera.
- 2 Point the camera towards the subject.
- 3 To start recording, tap .
- 4 To pause when recording a video, tap . To resume recording, tap .
- 5 To stop recording, tap .



To take a photo when recording a video

- To take a photo when recording a video, tap . The photo is taken as soon as you release your finger.

To view your photos and videos

- 1 Activate the camera, then tap a thumbnail to open a photo or video.
- 2 Flick left or right to view your photos and videos.





To delete a photo or recorded video

- 1 Browse to the photo or video that you want to delete.
- 2 Tap the screen to make  appear.
- 3 Tap .
- 4 Tap **Delete** to confirm.

Face detection

You can use face detection to bring an off-centre face into focus. The camera automatically detects up to five faces, indicated by white frames. A coloured frame shows which face has been selected for focus. Focus is set to the face closest to the camera. You can also tap one of the frames to select which face should be in focus.

To turn on face detection

- 1 Activate the camera.
- 2 Tap , then select .
- 3 Tap , then tap .
- 4 Tap **Focus mode** > **Face detection**.



To take a photo using face detection

- 1 When the camera is open and **Face detection** turned on, point the camera at your subject. Up to five faces can be detected, and each detected face is framed.
- 2 Tap the frame you want to select for focus. Do not tap if you want the camera to select focus automatically.
- 3 A coloured frame shows which face is in focus. Tap the screen to take the photo.

Using Smile Shutter™ to capture smiling faces

Use Smile Shutter™ technology to photograph a face just as it smiles. The camera detects up to five faces and selects one face for smile detection and auto focus. When the selected face smiles, the camera automatically takes a photo.

To turn on Smile Shutter™



- 1 Activate the camera.
- 2 Tap , then tap .
- 3 Tap **Smile Shutter** and select a smile level.

To take a photo using Smile Shutter™



- 1 When the camera is open and Smile Shutter™ is turned on, point the camera at your subject. The camera selects which face to focus on.
- 2 The face selected appears inside a coloured frame and the photo is taken automatically.
- 3 If no smile is detected, tap the screen to take the photo manually.

Adding the geographical position to your photos

Turn on geotagging to add the approximate geographical location (a geotag) to photos when you take them. The geographical location is determined either by wireless networks (mobile or Wi-Fi® networks) or GPS technology.











When  appears on the camera screen, geotagging is turned on but the geographical position has not been found. When  appears, geotagging is turned on and the geographical location is available, so your photo can get geotagged. When neither of these two symbols appears, geotagging is turned off.

To turn on geotagging

- 1 From your Home screen, tap .
- 2 Tap **Settings** > **Location**.
- 3 Tap the on-off switch.
- 4 Activate the camera.
- 5 Tap , then tap .
- 6 Drag the slider beside **Geotagging** to the right.

General camera settings

Capturing mode settings overview

-  **Superior auto**
Optimise your settings to suit any scene.
-  **Manual**
Adjust camera settings manually.
-  **Live on YouTube**
Broadcast live video to YouTube™.
-  **Background defocus**
Blur the background of your photos to make your subject look sharper in comparison.
-  **AR effect**
Take photos or videos with virtual scenes and characters.
-  **Creative effect**
Apply effects to photos or videos.
-  **Timeshift burst**
Find the best photo from a burst of images.
-  **Social live**
Broadcast live video to Facebook™.
-  **Sweep Panorama**
Take wide-angle and panoramic photos.
-  **Face in picture**
Take photos using the front and rear cameras at the same time.
-  **Multi camera**
Record the same scene from multiple angles on a single screen.

 **Sound Photo**
Take photos with background sound.

 **AR fun**
Play in your camera view finder with virtual objects and enrich your photos or videos.

Superior auto

Superior auto mode detects the conditions in which you are shooting and automatically adjusts the settings to ensure that you take the best photo possible.

Manual mode

Use Manual mode when you want to manually adjust your camera settings for taking photos and videos.

AR effect

You can apply AR (augmented reality) effects to your photos or videos and make them more fun. When using the camera, this setting lets you integrate 3D scenes into your photos or videos. Just select the scene you want and adjust its position in the viewfinder.



Creative effect

You can apply different effects on your photos or videos. For example, you can add a Nostalgic effect to make photos look older or a Sketch effect for a more fun image.

Sweep Panorama

You can take wide-angle and panoramic photos from the horizontal or vertical direction in an easy press-and-sweep motion.



To take a panoramic photo

- 1 Activate the camera.
- 2 Tap , then select .
- 3 To select a shooting direction, tap .
- 4 Tap the screen and move the camera slowly and steadily to the direction of movement indicated on the screen.

Timeshift burst

The camera takes a burst of 61 photos in a window of two seconds – one second before and after you tap the on-screen camera button. So you can go back and find the perfect image.





To use Timeshift burst

- 1 Activate the camera.
- 2 Tap , then select .
- 3 Take photos. The photos taken appear in thumbnail view.
- 4 Scroll through the thumbnails and select the photo that you want to save, then tap .

Social live

Social live is a camera shooting mode that lets you stream video live to your Facebook™ page. You just need to have an active internet connection and be logged into Facebook™. Videos can be up to 10 minutes long.

To broadcast live video using Social live

- 1 Activate the camera.
- 2 Tap , then select .
- 3 Log in to your Facebook™ account.
- 4 Tap  to start broadcasting.
- 5 To take a photo during the broadcast, tap .
- 6 To stop broadcasting, tap .

Background defocus mode

Use your camera's blurred background effect to make your subjects look sharper and more vivid in comparison to their background. In Background defocus mode, the camera takes two shots, identifies the background and then blurs it while keeping the subject sharp and in focus – like shooting with a digital SLR camera. You can select from three different blur variations and tune the blur level in the preview display.

Face in picture

You can use the Face in picture mode to turn on the front and main cameras at the same time, so you can take a photo of yourself together with the subject.





Multi camera mode

Multi camera mode lets you take a photo that combines images from two different angles and devices. You see two images in the camera viewfinder of your device – one from your own camera and one from a connected Xperia™ device or a Sony camera that supports NFC and Wi-Fi Direct™ technology. You can then edit what you see in the viewfinder before taking a photo.

So if you're at a concert venue, for example, and you want to capture a photo that combines a view of the band from one angle and the audience from another, you can use Multi camera mode for the best effect.

You can set up Multi camera mode using NFC, which launches the pairing of the two devices using Wi-Fi Direct™ technology.

To use Multi camera mode

- 1 Turn on the NFC functions on both devices that you want to connect.
- 2 Activate the camera on your device.
- 3 Tap , then select .
- 4 On the screens of both devices, tap .
- 5 Touch the NFC detection areas of each device to each other. Both devices should now connect using Wi-Fi Direct™ technology.
- 6 Once the devices are connected, two images appear in the viewfinder of your device – one from the viewfinder of your camera and another from the viewfinder of the connected device.
- 7 To edit the images in your viewfinder, tap .
- 8 Edit the images as desired. For example, you can tap and hold an image and drag it to the other side of the viewfinder to change the order.
- 9 When you are finished editing and are ready to capture the final combined image, tap **Done** > .

Downloading camera applications

You can download free or paid camera applications from Google Play™ or other sources. Before you start downloading, make sure that you have a working Internet connection, preferably over Wi-Fi® to limit data traffic charges.

To download camera applications

- 1 Open the camera application.
- 2 Tap , then tap **DOWNLOADABLE**.
- 3 Select the application that you want to download, and follow the instructions to complete the installation.

Quick launch

Use Quick launch settings to launch the camera when the screen is locked.

Launch only

After you drag  inwards, the main camera is launched from sleep mode.

Launch and capture

After you drag  inwards, the still camera is launched from sleep mode and a photo is captured.

Launch and record video

After you drag  inwards, the video camera is launched from sleep mode and starts recording.

Off

Geotagging

Tag photos with details of where you took them.

Touch capture

Identify a focus area, and then touch the camera screen with your finger. The photo is taken as soon as you release your finger.

Sound

Choose to turn on or turn off the shutter sound.

Data storage

You can choose to save your data either to a removable SD card or to your device's internal storage.

Internal storage

Photos or videos are saved on the device memory.

SD card.

Photos or videos are saved on the SD card.

Touch Block

You can disable the touch screen to avoid unintended touches when you are using the camera.

White balance

This setting, which is only available in **Manual** capturing mode, adjusts the colour balance according to the lighting conditions. It also allows you to adjust the exposure manually in the -2.0 EV to +2.0 EV range. For example, you can increase the image brightness or decrease the overall exposure by tapping the plus or minus controls accordingly when the white balance setting icon  is displayed.



Auto

Adjusts the colour balance automatically to suit the lighting conditions.



Incandescent

Adjusts the colour balance for warm lighting conditions, such as under light bulbs.



Fluorescent

Adjusts the colour balance for fluorescent lighting.



Daylight

Adjusts the colour balance for sunny outdoor conditions.



Cloudy

Adjusts the colour balance for a cloudy sky.

Still camera settings

To adjust the still camera settings

- 1 Activate the camera.
- 2 To display all settings, tap .
- 3 Select the setting that you want to adjust, then edit as desired.

Still camera settings overview

Resolution

Choose between several resolutions and aspect ratios before taking a photo. A photo with a higher resolution requires more memory.

8MP

3264×2448(4:3)

8 megapixel resolution with 4:3 aspect ratio. Suitable for photos that you want to view on non-widescreen displays or print in high resolution.

6MP

3264×1836(16:9)

6 megapixel picture size with 16:9 aspect ratio. Suitable for photos that you want to view on non-widescreen displays or print in high resolution.

3MP

2048×1536(4:3)

3 megapixel resolution with 4:3 aspect ratio. Suitable for photos that you want to view on non-widescreen displays or print in high resolution.

2MP

1920×1080(16:9)

2 megapixel resolution with 16:9 aspect ratio. Suitable for photos you want to view on widescreen displays.

- ! This setting is only available in **Manual** capturing mode.

Self-timer

With the self-timer, you can take a photo without holding the device. Use this function to take self-portraits or group photos where everyone can be in the photo. You can also use the self-timer if you want to avoid shaking the camera when taking photos.

On (10 sec.)

Set a 10-second delay from when you tap the camera screen until the photo is taken.

On (2 sec.)

Set a 2-second delay from when you tap the camera screen until the photo is taken.

On (0,5 sec.)

Set a half-second delay from when you tap the camera screen until the photo is taken.

Off

The photo is taken as soon as you tap the camera screen.

Smile Shutter™

Use the Smile Shutter™ function to determine what kind of smile the camera reacts to before taking a photo.

Focus mode

The focus function controls which part of a photo should be sharp. When continuous autofocus is on, the camera keeps adjusting focus so that the area within the focus frame stays sharp.

Single autofocus

The camera automatically focuses on the selected subject. Continuous autofocus is on. Touch and hold the camera screen until the focus frame changes colour, indicating that the focus is set. The photo is taken when you release your finger.

Multi autofocus

The focus is automatically set on several areas of the image. Touch and hold the camera screen until the focus frame changes colour, indicating that the focus is set. The photo is taken when you release your finger. Continuous autofocus is off.

Face detection

The camera automatically detects up to five human faces, indicated by frames on the screen. The camera automatically focuses on the nearest face. You can also select which face to focus on by tapping it on the screen. When you tap the camera screen, a coloured frame shows which face is selected and in focus. Face detection cannot be used for all scene types. Continuous autofocus is on.

Touch focus

Touch a specific area on the camera screen to set the area of focus. Continuous autofocus is off. Touch and hold the camera screen until the focus frame changes colour, indicating that the focus is set. The photo is taken when you release your finger.

Object tracking

When you select an object by touching it in the viewfinder, the camera tracks it for you.

- ! This setting is only available in **Manual** capturing mode.

HDR

Use the HDR (High Dynamic Range) setting to take a photo against strong back light or in conditions where the contrast is sharp. HDR compensates for the loss of detail and produces a picture that is representative of both dark and bright areas.

- ! This setting is only available in **Manual** capturing mode.

ISO

You can reduce image blurring caused by dark conditions or moving subjects by increasing the ISO sensitivity. Also, if you want to capture a bright image even in dark conditions, you can set the ISO sensitivity to a higher value.

Auto

Sets the ISO sensitivity automatically.

50

Sets the ISO sensitivity to 50.

100

Sets the ISO sensitivity to 100.

200

Sets the ISO sensitivity to 200.

400

Sets the ISO sensitivity to 400.

800

Sets the ISO sensitivity to 800.

1600

Sets the ISO sensitivity to 1600.

- ! This setting is only available in **Manual** capturing mode.

Metering

This function automatically determines a well-balanced exposure by measuring the amount of light striking the image you want to capture.

Center

Measures the centre of the image, and determines the exposure based on the brightness of the subject there.

Spot

Adjusts the exposure in a very small part of the image that you want to capture.

Face

Measures the amount of light on the face, and adjusts the exposure so that the face is neither too dark or too bright.

Multi

Divides the image into multiple regions, and measures each region to determine a well-balanced exposure.

! This setting is only available in **Manual** capturing mode.

Image stabiliser

When taking a photo, it can be difficult to hold the device steady. The stabiliser helps you by compensating for small movements of the hand.

! This setting is only available in **Manual** capturing mode.

Preview

You can choose to preview photos or videos just after you shoot them.

Unlimited

The preview of the photo or video appears after you shoot it.

5 seconds

The preview of the photo or video appears for 5 seconds after you shoot it.

3 seconds

The preview of the photo or video appears for 3 seconds after you shoot it.

Edit

The photo or video opens for editing after you shoot it.

Off

The photo or video is saved after you shoot it, and no preview appears.

Face recognition

You can register faces in the Camera application so that the camera automatically focuses on these faces when they appear in the viewfinder.

Scene selection

Use the Scene selection feature to quickly set up the camera for common situations using pre-programmed scenes. The camera determines a number of settings for you to fit the selected scene, ensuring the best possible photo.

SCN Off

The Scene selection feature is off and you can take photos manually.



Soft skin

Take photos of faces using an enhanced beauty effect.



Soft snap

Use for shooting photos against a soft background.



Anti motion blur

Use for minimising camera shake when shooting a slightly dark scene.



Landscape

Use for landscape photos. The camera focuses on distant objects.













Backlight correction HDR

Use to improve details in high contrast shots. The built-in backlight correction analyses the image and automatically adjusts it to give you a perfectly lit shot.



Night portrait





Use for portrait photos taken at night or in poorly lit environments. Due to long exposure time, the camera must be held still or placed on a stable surface.

-  **Night scene**
Use when taking photos at night or in poorly lit environments. Due to long exposure time, the camera must be held still or placed on a stable surface.
-  **Hand-held twilight**
Use for taking hand-held low-light photos with reduced noise and blur.
-  **High sensitivity**
Use for taking photos without a flash under low light conditions. Reduces blur.
-  **Gourmet**
Use for shooting food arrangements in bright colour.
-  **Pet**
Use for taking photos of your pet. Reduces blur and red eyes.
-  **Beach**
Use for taking photos of seaside or lakeside scenes.
-  **Snow**
Use in bright environments to avoid overexposed photos.
-  **Party**
Use for indoor photos in poorly lit environments. This scene picks up indoor background lighting or candlelight. Due to long exposure time, the camera must be held still or placed on a stable surface.
-  **Sports**
Use for photos of fast-moving objects. Short exposure time minimises motion blurring.
-  **Document**
Use for photos of text or drawings. Gives the photo increased, sharper contrast.
-  **Fireworks**
Use for taking photos of fireworks in all their splendour.

! This setting is only available in **Manual** capturing mode.

Video camera settings

To adjust the video camera settings

- 1 Activate the camera.
- 2 Tap , then select .
- 3 If the video camera is not selected, tap .
- 4 To display all settings, tap .
- 5 Select the setting that you want to adjust, then make your changes.

Video camera settings overview

Video resolution

Adjust the video resolution for different formats.

Full HD

1920×1080(16:9)

Full HD (Full High Definition) format with 16:9 aspect ratio. 1980×1080 pixels.

HD

1280×720(16:9)

HD (High Definition) format with 16:9 aspect ratio. 1280×720 pixels.

VGA

640×480(4:3)

VGA format with 4:3 aspect ratio.

MMS

Record videos suitable for sending in multimedia messages. The recording time of this video format is limited so that video files can fit in a multimedia message.

! This setting is only available in **Manual** capturing mode.

Self-timer

With the self-timer, you can record a video without holding the device. Use it to record group videos where everyone can be in the video. You can also use the self-timer if you want to avoid shaking the camera when recording videos.

On (10 sec.)

Set a 10-second delay from when you tap the camera screen until the video begins to record.

On (2 sec.)

Set a 2-second delay from when you tap the camera screen until the video begins to record.

On (0.5 sec.)

Set a half-second delay from when you tap the camera screen until the video begins to record.

Off

The video begins to record as soon as you tap the camera screen.

Smile Shutter™(video)

Use the Smile Shutter™ function to determine what kind of smile the camera reacts to before recording a video.

Focus mode

The focus setting controls which part of a video should be sharp. When continuous autofocus is on, the camera keeps adjusting focus so that the area within the white focus frame stays sharp.

Single autofocus

The camera automatically focuses on the selected subject. Continuous autofocus is on.

Face detection

The camera automatically detects up to five human faces, indicated by frames on the screen. The camera automatically focuses on the nearest face. You can also select which face to focus on by tapping it on the screen. When you tap the camera screen, a yellow frame shows which face is selected and in focus. Face detection cannot be used for all scene types. Continuous autofocus is on.

Object tracking

When you select an object by touching it in the viewfinder, the camera tracks it for you.

- ! This setting is only available in **Manual** capturing mode.

HDR video

Use the video HDR (High-Dynamic Range) setting to record a video against strong back light or in conditions where the contrast is sharp. Video HDR compensates for the loss of detail and produces a picture that is representative of both dark and bright areas.

- ! This setting is only available in **Manual** capturing mode.

Metering

This function automatically determines a well-balanced exposure by measuring the amount of light striking the image you want to capture.

Center

Measures the centre of the image, and determines the exposure based on the brightness of the subject there.

Spot

Adjusts the exposure in a very small part of the image that you want to capture.

Face

Measures the amount of light on the face, and adjusts the exposure so that the face is neither too dark or too bright.

Multi

Divides the image into multiple regions, and measures each region to determine a well-balanced exposure.

! This setting is only available in **Manual** capturing mode.

SteadyShot™

When recording a video, it can be difficult to hold the device steady. The stabiliser helps by compensating for the small movements of your hand.

Standard

Activate to remove the camera shakes.

Off

The stabiliser is turned off.

Microphone

Select whether to pick up the surrounding sound when recording videos.

Preview

You can choose to preview videos just after you shoot them.

On

The preview of the video appears after you shoot it.

Edit

The video opens for editing after you shoot it.

Off

The video is saved after you shoot it, and no preview appears.

Scene selection

The Scene selection feature helps you to quickly set up the camera for common situations using pre-programmed video scenes. The camera determines a number of settings for you to fit the selected scene, ensuring the best possible video.

SCN Off

The Scene selection feature is off and you can shoot videos manually.



Soft snap

Use for shooting videos against soft backgrounds.



Landscape

Use for videos of landscapes. The camera focuses on distant objects.



Night

When turned on, light sensitivity is increased. Use in poorly lit environments. Videos of fast-moving objects may get blurred. Hold your hand steady, or use a support. Turn off night mode when lighting conditions are good, to improve the video quality.



Beach

Use for videos of seaside or lakeside scenes.



Snow

Use in bright environments to avoid overexposed videos.



Sports

Use for videos of fast-moving objects. Short exposure time minimises motion blurring.



Party

Use for indoor videos in poorly lit environments. This scene picks up indoor background lighting or candlelight. Videos of fast-moving objects may get blurred. Hold your hand steady, or use a support.

! This setting is only available in **Manual** capturing mode.

Photos and videos in Album

Viewing photos and videos

Use the Album application to view photos and play videos that you've taken with your camera, or to view similar content that you've saved to your device. All photos and videos are displayed in a chronologically ordered grid.

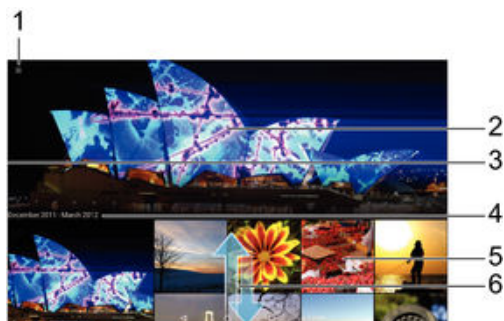

- 1 Tap the icon to open the Album home screen menu
- 2 View a slideshow of all images or just the ones you've added to your favourites
- 3 Drag the left edge of the screen to the right to open the Album home screen menu
- 4 The date range of items in the current group
- 5 Tap a photo or video to open it in full screen view
- 6 Scroll up or down to view content

To view photos and videos

- 1 From your Home screen, tap .
- 2 Find and tap **Album**.
- 3 Tap a photo or video that you want to view. If prompted, tap **Album** or **Video**.
- 4 Flick left to view the next photo or video. Flick right to view the previous photo or video.

! If you want to change an application that you have chosen as the default to always open videos, tap **Settings** > **Apps** and swipe over to the **All** tab, then select the application and tap **CLEAR DEFAULTS** under **Launch by default**.

💡 If the screen orientation does not change automatically when you turn your device sideways, activate the **Auto-rotate screen** button under **Settings** > **Display** > **Screen rotation**.

To change the size of the thumbnails

- When viewing thumbnails of photos and videos in Album, spread two fingers apart to zoom in, or pinch two fingers together to zoom out.

To zoom a photo

- When you are viewing a photo, spread two fingers apart to zoom in, or pinch two fingers together to zoom out.

To watch a slideshow of your photos

- 1 When you are viewing a photo, tap the screen to display the toolbars, then tap  > **Slideshow** to start playing all the photos in an album.
- 2 Tap a photo to end the slideshow.

To play a video

- 1 In Album, find and tap the video that you want to play.
- 2 Tap , then tap **Video** > **Just once**.
- 3 If the playback controls are not displayed, tap the screen to display them. To hide the controls, tap the screen again.

To pause a video

- 1 When a video is playing, tap the screen to display the controls.
- 2 Tap .

To fast forward and rewind a video

- 1 When a video is playing, tap the screen to display the controls.
- 2 Drag the progress bar marker left to rewind, or right to fast forward.

To adjust the volume of a video

- Press the volume key.

Sharing and managing photos and videos

You can share photos and videos that you've saved on your device. You can also manage them in different ways. For example, you can work with photos in batches, delete photos and link them to contacts. If you have lots of photos saved on your device, it's a good idea to regularly transfer them to a computer or to an external storage device in order to avoid any unpredictable loss of data. Doing so also frees up more space of your device. See *Managing files using a computer* on page 132 .

- ! You might not be able to copy, send or transfer copyright-protected items. Also, some items may not send if the file size is too large.

To share a photo or video

- 1 In Album, find and tap the photo or video that you want to share.
- 2 Tap the screen to display the toolbars, then tap .
- 3 Tap the application that you want to use to share the photo, then follow the steps to send it.

To use a photo as a contact picture

- 1 When you are viewing a photo, tap the screen to display the toolbars, then tap  > **Use as** > **Contact picture**.
- 2 Select a contact, then edit photo as desired.
- 3 Tap **Done**.

To use a photo as wallpaper

- 1 When you are viewing a photo, tap the screen to display the toolbars, then tap  > **Use as** > **Wallpaper**.
- 2 Follow the instructions on the screen.

To rotate a photo

- 1 When you are viewing a photo, tap the screen to display the toolbars, then tap .
- 2 Select **Rotate**. The photo is saved in the new orientation.

To delete a photo or video

- 1 When you are viewing a photo, tap the screen to display the toolbars, then tap .
- 2 Tap **Delete**.

To work with batches of photos or videos in Album

- 1 When viewing thumbnails of photos and videos in Album, touch and hold an item until it is highlighted.
- 2 Tap other items that you want to work with to select them. If you want to select all items, tap  then tap **Select all**.
- 3 Use the tools in the toolbar to work with your selected items.

Analysing photos with faces in Album

You can analyse any photos on your device that feature people's faces. Once activated, the photo analysis feature stays on, and new photos get analysed as they are added. After running an analysis, you can then group all photos of the same person in one folder.

To turn on the photo analysis feature

- 1 From your Home screen, tap .
- 2 Find and tap **Album**.
- 3 Drag the left edge of the Album home screen to the right, then tap **Faces**. All photos on your device get analysed and grouped in the Unnamed faces folder.

To name a face

- 1 In the **Faces** tile, tap the **Unnamed faces** folder, then browse to the **Other faces** folder and choose the face that you want to name.
- 2 Tap **Add name**.
- 3 Type a name, then tap **Done** > **Add as new person**.

To edit a face name

- 1 When you are viewing a face in full screen view, tap the screen to display the toolbars, then tap  > **Edit name tags**.
- 2 Tap **OK**.
- 3 Tap the name of the face that you want to edit.
- 4 Edit the name, then tap **Done** > **Add as new person**.



Editing photos with the Photo editor application

You can edit and apply effects to original photos that you've taken with your camera. For example, you can change the light effects. After you save the edited photo, the original unchanged version of the photo remains on your device.



To edit a photo

- When you are viewing a photo, tap the screen to display the toolbars, then tap .



To crop a photo

- 1 When you are viewing a photo, tap the screen to display the toolbars, then tap .
- 2 If prompted, select **Photo editor**.
- 3 Tap  > **Crop**.
- 4 Tap **Crop** to select an option.
- 5 To adjust the crop frame, touch and hold the edge of the crop frame. When the squares at the edges disappear, drag inward or outward to resize the frame.
- 6 To resize all sides of the crop frame at the same time, touch and hold one of the four corners to make the squares at the edges disappear, then drag the corner accordingly.
- 7 To move the crop frame to another area of the photo, touch and hold inside the frame, then drag it to the desired position.
- 8 Tap .
- 9 To save a copy of the photo as you cropped it, tap **Save**.



To apply special effects to a photo

- 1 When you are viewing a photo, tap the screen to display the toolbars, then tap .
- 2 If prompted, select **Photo editor**.
- 3 Tap , then select an option.
- 4 Edit the photo as desired, then tap **Save**.



To improve a photo using advanced settings

- 1 When you are viewing a photo, tap the screen to display the toolbars, then tap .
- 2 If prompted, select **Photo editor**.
- 3 Tap , then select an option.
- 4 To save a copy of the edited photo, tap **Save**.

To adjust the light settings for a photo

- 1 When you are viewing a photo, tap the screen to display the toolbars, then tap .
- 2 If prompted, select **Photo editor**.
- 3 Tap , then select an option and edit as desired.
- 4 To save a copy of the edited photo, tap **Save**.

To set the saturation level of colours in a photo

- 1 When you are viewing a photo, tap the screen to display the toolbars, then tap .
- 2 If prompted, select **Photo editor**.
- 3 Tap , then select an option.
- 4 To save a copy of the edited photo, tap **Save**.

Editing videos with the Movie Creator application

You can edit videos that you've taken with your camera. For example, you can trim a video to the desired length or adjust the speed of a video. After you save the edited video, the original unchanged version of the video remains on your device.

To trim a video

- 1 In Album, find and tap the video that you want to play.
- 2 Tap the screen to display the toolbars, then tap  > **Trim**.
- 3 To move the trim frame to another part of the timeline, touch and hold the edge of the trim frame and drag it to the desired position, then tap **Apply**.
- 4 To save a copy of the trimmed video, tap **Save**.

To adjust the speed of a video

- 1 In Album, find and tap the video that you want to play.
- 2 Tap the screen to display the toolbars, then tap  > **Speed**.
- 3 Select an option, then touch and hold the edge of the timeline and drag it to the desired position and tap **Apply**.
- 4 To save a copy of the edited video, tap **Save**.

Hiding photos and videos

You can hide any photos and videos from the Album home screen. Once photos and videos are hidden from the Album home screen, they can only be viewed from the Hidden folder.

To hide a photo or video

- 1 In Album, find and tap the photo or video that you want to hide.
- 2 Tap the screen to display the toolbars, then tap .
- 3 Tap **Hide** > **OK**.

To view your hidden photos and videos

- 1 In Album, drag the left edge of the Album home screen to the right, then tap **Hidden**.
- 2 Tap a photo or video to view it.
- 3 Flick left to view the next photo or video. Flick right to view the previous photo or video.

To unhide a photo or video

- 1 In Album, drag the left edge of the Album home screen to the right, then tap **Hidden**.
- 2 Tap a photo or video that you want to unhide.
- 3 Tap the screen to display the toolbars, then tap .
- 4 Tap **Don't hide**.

Album home screen menu

Through the Album home screen menu you can browse to all your photo albums, including photos and videos taken by your device's camera using special effects, as well as content that you share online via services such as PlayMemories Online, Picasa™ and Facebook. Once you are logged in to such services, you can manage content and view online images. From the Album application, you can also add geotags to photos, perform basic editing tasks, and use methods such as Bluetooth® wireless technology and email to share content.

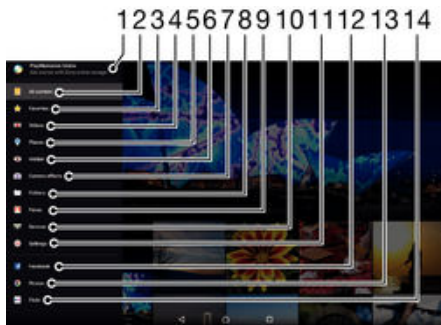

- 1 View photos and videos using the PlayMemories Online service
- 2 Return to the Album application home screen to view all content
- 3 View your favourite photos and videos
- 4 View all videos saved to your device
- 5 View your photos on a map or in Globe view
- 6 View your photos and videos that you have hidden from view
- 7 View all photos and videos taken by your device's camera using special effects
- 8 View all photos and videos saved to your device in different folders
- 9 View all photos with faces
- 10 View photos and videos on devices in the same network
- 11 Open the settings menu for the Album application
- 12 View photos and videos on Facebook™
- 13 View photos and videos on Picasa™
- 14 View photos using the Flickr™ online service

! The PlayMemories Online service is not available in all countries or regions.

To view photos from online services in Album

- 1 From your Home screen, tap .
- 2 Find and tap **Album**, then drag the left edge of the Album home screen to the right.
- 3 Tap the desired online service, then follow the on-screen instructions to get started with it. All available online albums that you have uploaded to the service are displayed.
- 4 Tap any album to view its content, then tap a photo in the album.
- 5 Flick left to view the next photo or video. Flick right to view the previous photo or video.

Viewing your photos on a map

Adding location information to photos is referred to as geotagging. You can view and tag your photos on a map and show friends and family where you were when you took a particular photo. See *Adding the geographical position to your photos* on page 86 for more information.

- If you have turned on location detection and activated geotagging in the camera, you can tag your photos directly for map viewing at a later stage.

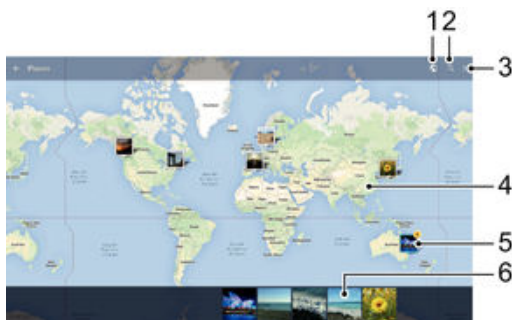

- 1 View geotagged photos in Globe view
- 2 Search a location on the map
- 3 View menu options
- 4 Double tap to zoom in. Pinch to zoom out. Drag to view different parts of the map
- 5 A group of photos and/or videos geotagged with the same location
- 6 Thumbnails of the selected group of photos and/or videos. Tap an item to view it in full screen

- If several photos were taken at the same location, only one of them appears on the map. The total number of photos appears in the top right corner, for example, . To view all photos in the group, tap the cover photo and then tap one of the thumbnails at the bottom of the screen.



To add a geotag to a photo

- 1 When you are viewing a photo, tap the screen to display the toolbars.
- 2 Tap , then tap **Add geotag** to open the map screen.
- 3 Tap on the map to set the location for the photo.
- 4 To reset the location for the photo, tap the new location on the map.
- 5 When you are finished, tap **OK**.

To view geotagged photos on a map

- 1 From your Home screen, tap .
- 2 Find and tap **Album**.
- 3 Drag the left edge of the Album home screen to the right, then tap **Places**.
- 4 Tap the photo that you want to view on a map.

To view geotagged photos on a globe

- 1 From your Home screen, tap .
- 2 Find and tap **Album**.
- 3 Drag the left edge of the Album home screen to the right, then tap **Places** > .
- 4 Tap the photo that you want to view on a globe.

To change the geotag of a photo

- 1 When viewing a photo on the map in Album, touch and hold the photo until its frame turns blue, then tap the desired location on the map.
- 2 Tap **OK**.

To change the map view

- When viewing the map in Album, tap ; then select **Classic view** or **Satellite view**.

Videos

Watching videos in the Video application

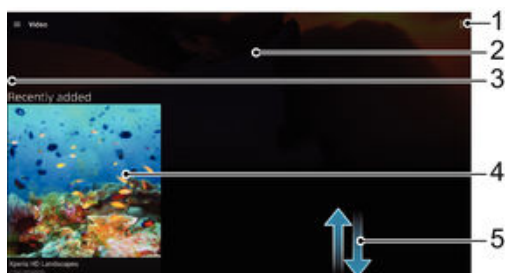

Use the Video application to play movies and other video content that you've saved or downloaded to your device. The Video application also helps you get poster art, plot summaries, genre info and director details for each movie. You can also play your movies on other devices that are connected to the same network.

- ! Some video files may not be playable in the Video application.



- 1 View menu options
- 2 Display the most recently played video
- 3 Drag the left edge of the screen to the right to browse all downloaded and saved videos
- 4 Tap to play saved or downloaded video files
- 5 Scroll up or down to view content



To play a video in Video

- 1 From your Home screen, tap , then find and tap **Video**.
- 2 Find and tap the video that you want to play. If the video is not displayed on the screen, drag the left edge of the screen to the right to open the Video home screen menu, then find and tap the video that you want to play.
- 3 To display or hide the controls, tap the screen.
- 4 To pause playing, tap . To resume playing, tap .
- 5 To rewind, drag the progress bar marker to the left. To fast forward, drag the progress bar marker to the right.

To play a video on an external device

- 1 When the video is playing, tap the screen to display all the controls.
- 2 Tap  > **Throw**.
- 3 Select an external device on which to play the video. If there is no external device available, follow the on-screen instructions to add one.

To change settings in Video

- 1 From your Home screen, tap , then find and tap **Video**.
- 2 Tap  > **Settings**, then change the settings as desired.

To change the sound settings while a video is playing

- 1 While a video is playing, tap the screen to display the controls.
- 2 Tap  > **Audio settings**, then change the settings as desired.
- 3 When you're finished, tap **OK**.

To share a video

- 1 When a video is playing, tap , then tap **Share**.
- 2 Tap the application that you want to use to share the selected video, then follow the relevant steps to send it.

Transferring video content to your device

Before you start using the Video application, it's a good idea to transfer movies, TV shows and other video content to your device from other devices, such as a computer. There are several ways to transfer your content:

- Connect your device to a computer using a USB cable and drag and drop the video files directly using the file manager application on the computer. See *Managing files using a computer* on page 132 .
- If you have a PC, use the Media Go™ application from Sony to organise content and transfer video files to your device via the PC. To learn more and download the Media Go™ application, go to <http://mediago.sony.com/enu/features>.
- If your computer is an Apple® Mac®, you can use Sony Bridge for Mac to transfer video files from iTunes to your device. To learn more and download Sony Bridge for Mac, go to www.sonymobile.com/global-en/tools/bridge-for-mac/.

Managing video content

To get movie information manually

- 1 Make sure that your device has an active data connection.
 - 2 From your Home screen, tap , then find and tap **Video**.
 - 3 Drag the left edge of the screen to the right to open the Video home screen menu, then browse through the different categories and to the video file that you want to get information.
 - 4 Touch and hold the thumbnail for the video, then tap **Search for info**.
 - 5 In the search field, enter keywords for the video, then tap the confirm key on the keyboard. All matches are displayed in a list.
 - 6 Select a search result, then tap **Done**. The download of the information begins.
- ! You can get information about newly added videos automatically every time the Video application opens if you mark the **Get video details** checkbox under Settings.
- 💡 If the downloaded information is not correct, search again using different keywords.

To clear information about a video

- 1 From your Home screen, tap , then find and tap **Video**.
- 2 Drag the left edge of the screen to the right to open the Video home screen menu, then browse through the different categories and to the video file that you want to edit.
- 3 Touch and hold the video thumbnail, then tap **Clear info**.

To delete a video

- 1 From your Home screen, tap , then find and tap **Video**.
- 2 Drag the left edge of the screen to the right to open the Video home screen menu, then browse through the different categories and to the video file that you want to delete.
- 3 Touch and hold the video thumbnail, then tap **Delete** from the list that appears.
- 4 Tap **Delete** again to confirm.

Movie Creator

The Xperia™ Movie Creator automatically creates short videos of around 30 seconds in length using existing photos and videos. The application automatically determines the timeline to create its movie. For example, it could take a selection of photos and videos from a Saturday afternoon outing or from a random seven-day period and



create a movie for you. When this highlight-style movie is ready, you get notified. You can then edit it as desired. For example, you can edit the title, delete scenes, change the music or add more photos and videos.

To open Movie Creator

- 1 From your Home screen, tap .
- 2 Find and tap **Movie Creator**.

! If no photos or videos are saved on your device, no functionality is available when you open the Movie Creator application.

To turn off Movie Creator notifications

- 1 From your Home screen, tap .
- 2 Find and tap Movie Creator.
- 3 Tap , then tap Settings and deactivate Notifications.

To disable Movie Creator

- 1 From your Home screen, tap .
- 2 Find and tap **Settings > Apps > All**.
- 3 Find and tap **Movie Creator > Disable**.

Connectivity

Mirroring the screen of your device on a TV using a cable

You can connect your device to a compatible TV set using an MHL cable and mirror the screen of your device on the TV screen.

💡 MHL and HDMI™ cables and adaptors are sold separately.

! Sony does not guarantee that all types of MHL and HDMI™ cables and adaptors are supported by your device.

To view content from your device on a TV which supports MHL input

- 1 Connect your device to the TV using an MHL cable. **MHL** appears in your device's status bar after a connection is established.
- 2 The TV displays the screen of your device.

To view content from your device on a TV which supports HDMI™ input

- 1 Connect your device to an MHL adaptor, and connect the adaptor to a powered USB port.
- 2 Connect the adaptor to a TV using an HDMI™ cable. **MHL** appears in your device's status bar after a connection is established.
- 3 The TV displays the screen of your device.

To view help about using a TV remote control

- 1 While your device is connected to the TV set, drag the status bar downwards to open the Notification panel.
 - 2 Tap **MHL connected**. The MHL settings appear on the TV screen.
 - 3 Select **Remote control usage**.
- ! You can select **Video Output Size** to adjust the size of the output on the TV screen. If the TV already has an auto scaling option enabled, this setting does not appear under the MHL settings.
- 💡 You can also press the yellow button on the TV remote control to open the Notification panel.



To disconnect your device from a TV set

- Disconnect the MHL cable or the MHL adaptor from your device.

Mirroring the screen of your device wirelessly

You can use the Screen mirroring feature to share the screen of another Xperia™ device on the screen of your device without using a cable connection. You can also view content on your device on a display or TV that supports Wi-Fi CERTIFIED Miracast™.

To mirror the screen of an Xperia™ device on your device

- 1 **Your device:** From your Home screen, tap .
- 2 Find and tap **Settings > Xperia™ Connectivity > Screen mirroring**.
- 3 Under **Receive**, tap **Start**.
- 4 **Other device:** From the Home screen, tap .
- 5 Find and tap **Settings > Xperia™ Connectivity > Screen mirroring > Start**.
- 6 Tap **OK** and select a device.
- 7 **Your device:** Tap **Accept** to allow a connection to your device.

To mirror the screen of your device on a TV screen

- 1 TV: Follow the instructions in the User guide of your TV to turn on the screen mirroring function.
- 2 Your device: From your Home screen, tap .
- 3 Find and tap **Settings** > **Xperia™ Connectivity** > **Screen mirroring**.
- 4 Under **Send**, tap **Start**.
- 5 Tap **OK** and select a device.

! When using screen mirroring, do not cover the Wi-Fi antenna area of your device.

! Your TV must support screen mirroring based on Wi-Fi CERTIFIED Miracast™ for the functionality described above to work.

To stop screen mirroring between devices

- 1 From your Home screen, tap .
- 2 Find and tap **Settings** > **Xperia™ Connectivity** > **Screen mirroring**.
- 3 Tap **Disconnect**, then tap **OK**.

Sharing content with DLNA Certified™ devices



You can view or play media content saved to your device on other devices such as a TV or a computer. These devices must be on the same wireless network and can be Sony TVs or speakers, or products that are DLNA Certified™ by the Digital Living Network Alliance. You can also view or play content from other DLNA Certified™ devices on your device.

After you set up media sharing between devices, you can, for example, listen to music files stored on your home computer from your device, or view photos taken with your device's camera on a large-screen TV.

Playing files from DLNA Certified™ devices on your device

When you play files from another DLNA Certified™ device on your device, this other device acts as a server. In other words, it shares content over a network. The server device must have its content sharing function enabled and give access permission to your device. It also must be connected to the same Wi-Fi® network as your device.

To play a shared music track on your device

- 1 Make sure the devices that you want to share files with are connected to the same Wi-Fi® network as your device.
- 2 From your Home screen, tap , then find and tap .
- 3 Drag the left edge of the Music home screen to the right, then tap **Devices**.
- 4 Select a device from the list of connected devices.
- 5 Browse the folders of the connected device and select the track that you want to play. Once selected, the track starts playing automatically.

To play a shared video on your device

- 1 Make sure the devices that you want to share files with are connected to the same Wi-Fi® network as your device.
- 2 From your Home screen, tap , then find and tap **Video**.
- 3 Drag the left edge of the Video home screen to the right, then tap **Devices**.
- 4 Select a device from the list of connected devices.
- 5 Browse the folders of the connected device and select the video that you want to play.





To view a shared photo on your device

- 1 Make sure the devices that you want to share files with are connected to the same Wi-Fi® network as your device.
- 2 From your Home screen, tap , then find and tap **Album**.
- 3 Drag the left edge of the Album home screen to the right, and tap **Devices**.
- 4 Select a device from the list of connected devices.
- 5 Browse the folders of the connected device and select a photo to view it.

Playing files from your device on DLNA Certified™ devices

Before you can view or play media files from your device on other DLNA Certified™ devices, you must set up file sharing on your device. The devices that you share content with are called client devices. For example, a TV, computer or tablet can act as client devices. Your device works as a media server when it makes content available to client devices. When you set up file sharing on your device, you must also give access permission to client devices. After you do so, such devices appear as registered devices. Devices that are waiting for access permission are listed as pending devices.

To set up file sharing with other DLNA Certified™ devices

- 1 Connect your device to a Wi-Fi® network.
 - 2 From your Home screen, tap , then find and tap .
 - 3 Tap , then tap **Media server**.
 - 4 To turn on the **Share media** function, drag the slider.  appears in the status bar. Your device can now work as a media server.
 - 5 Connect your computer or other devices to the same Wi-Fi® network as your device.
 - 6 A notification appears in the status bar of your device. Open the notification and set access permissions for each device.
- ! The instructions for setting up file sharing using DLNA™ differ depending on the client device. Refer to your client device User guide for more information. If the device cannot connect to a client on the network, check if your Wi-Fi® network is working.
- 💡 You can also access the **Media server** menu under **Settings > Xperia™ Connectivity > Media server settings**. If you close the **Media server** view, the file sharing function stays running in the background.

To stop sharing files with other DLNA Certified™ devices

- 1 From your Home screen, tap .
- 2 Find and tap **Settings > Xperia™ Connectivity > Media server settings**.
- 3 Drag the slider beside **Share media** to the left.

To set access permissions for a pending device

- 1 From your Home screen, tap .
- 2 Find and tap **Settings > Xperia™ Connectivity > Media server settings**.
- 3 Select a device from the **Pending devices** list.
- 4 Select an access permission level.

To change the name of a registered device

- 1 From your Home screen, tap .
- 2 Find and tap **Settings > Xperia™ Connectivity > Media server settings**.
- 3 Select a device from the **Registered devices** list, then select **Change name**.
- 4 Enter a new name for the device.

To change the access level of a registered device

- 1 From your Home screen, tap .
- 2 Find and tap **Settings > Xperia™ Connectivity > Media server settings**.
- 3 Select a device from the **Registered devices** list.
- 4 Tap **Change access level** and select an option.

To get help about sharing content with other DLNA Certified™ devices

- 1 From your Home screen, tap .
- 2 Find and tap **Settings > Xperia™ Connectivity > Media server settings**.
- 3 Tap .





Playing files on a Digital Media Renderer device

Using DLNA™ technology, you can push media content saved on your device to another device connected to the same Wi-Fi® network. The other device must be





able to function as a Digital Media Renderer (DMR) device and render or play content received from your device. A TV with DLNA features or a PC running Windows® 7 or higher are examples of DMR devices.

- ! The settings for enabling the Digital Media Renderer may vary depending on the device. Refer to the user guide of the DMR device for more information.
- ! Content secured with Digital Rights Management (DRM) cannot be played on a Digital Media Renderer device using DLNA™ technology.

To view photos or videos from your device on a DMR device

- 1 Make sure that you have correctly set up the DMR device and that it is connected to the same Wi-Fi® network as your device.
 - 2 From your Home screen, tap .
 - 3 Find and tap **Album**.
 - 4 Browse and open the photos or videos that you want to view.
 - 5 Tap the screen to display the toolbar, then tap  and select a DMR device that you want to share your content with. The selected content starts playing in chronological order on the device that you select.
 - 6 To disconnect from the DMR device, tap  and select **Disconnect**. The file stops playing on the DMR device but continues playing on your device.
- 💡 You can also share a video from the Video application on your device by tapping the video and then tapping .

To play a music track from your device on a DMR device

- 1 Make sure that you have correctly set up the DMR device and that it is connected to the same Wi-Fi® network as your device.
- 2 From your Home screen, tap , then find and tap .
- 3 Select a music category and browse to the track that you want to share, then tap the track.
- 4 Tap  and select a DMR device to share your content with. The track plays automatically on the device that you select.
- 5 To disconnect from the DMR device, tap  and select your device. The track stops playing on the DMR device but continues playing on your device.

Connecting your device to USB accessories

You can use a USB Host adapter to connect your device to USB accessories such as USB mass storage devices, game controllers, USB keyboards and USB mice. If the USB accessory has a micro USB connector, a USB Host adapter is not necessary.

- ! USB Host adapters are sold separately. Sony does not guarantee that all USB accessories are supported by your device.

To connect a USB accessory using a USB host adapter

- Attach the USB Host adapter to your device, then connect the adapter to the USB accessory.
- ! Additional steps or software may be required to set up game controllers, USB audio and USB Ethernet accessories. Sony does not guarantee that all USB accessories are supported by your device.

To access content on a USB mass storage device using a USB Host adapter

- 1 Attach the USB Host adapter to your device, then connect the adapter to the USB mass storage device.
 - 2 To access files and folders on the USB storage device, use a file manager app such as File Commander.
- 💡 You can also open the relevant media application on your device to view content directly. For example, you can open the Album application to view photos stored on the USB mass storage device.

To disconnect a USB mass storage device

- 1 To open the Notification Panel, drag the status bar downwards, then tap **USB storage connected**.
- 2 Tap **OK**.
- 3 Detach the USB Host adapter from your device.

To connect a USB accessory using a micro USB connector

- Attach the micro USB connector of the USB accessory to your device.
- ! Sony does not guarantee that all USB accessories with a micro USB connector are supported by your device.

Connecting your device to a DUALSHOCK™ series wireless controller

You can play games stored on your device using a DUALSHOCK™ series wireless controller. You can also mirror your device on a TV or other display. For more information about Screen mirroring, refer to the relevant section of the User guide.

To set up a connection with a DUALSHOCK™3 wireless controller

- 1 From your Home screen, tap .
- 2 Find and tap **Settings** > **Xperia™ Connectivity** > **DUALSHOCK™ series** > **DUALSHOCK™3**.
- 3 Tap **Pair controller** and follow the on-screen instructions.

To connect a DUALSHOCK™4 wireless controller to your device

- 1 From your Home screen, tap .
- 2 Find and tap **Settings** > **Xperia™ Connectivity** > **DUALSHOCK™ series**.
- 3 Select **DUALSHOCK™4**, then follow the on-screen instructions to complete the connection.

NFC

Use Near Field Communications (NFC) to share data with other devices, such as a video, photo, web page address, music file or contact. You can also use NFC to scan tags that give you more information about a product or service as well as tags that activate certain functions on your device.



NFC is a wireless technology with a maximum range of one centimetre, so the devices sharing data must be held close to each other. Before you can use NFC, you must first turn on the NFC function, and the screen of your device must be active.

- ! NFC may not be available in all countries and/or regions.



To turn on the NFC function

- 1 From your Home screen, tap .
- 2 Find and tap **Settings** > **More**.
- 3 Tap the on-off switch beside **NFC**.

To share a contact with another device using NFC

- 1 Make sure that both devices have the NFC function turned on, and that both screens are active.
- 2 To view contacts, go to your Home screen, tap , then tap .
- 3 Tap the contact that you want to share.
- 4 Hold your device and the receiving device back to back so that the NFC detection areas of each device touch each other. When the devices connect, a thumbnail of the contact appears.
- 5 Tap the thumbnail to start the transfer.
- 6 When the transfer is done, the contact information is displayed on the screen of the receiving device and is also saved on the receiving device.



To share a music file with another device using NFC

- 1 Make sure that both your device and the receiving device have the NFC function turned on, and that both screens are active.
- 2 To open the Music application, tap , then find and tap .
- 3 Select a music category and browse to the track you want to share.
- 4 Tap the track to play it. You can then tap  to pause the track. The transfer works whether the track is playing or paused.
- 5 Hold your device and the receiving device back to back so that the NFC detection areas of each device touch each other. When the devices connect, a thumbnail of the track appears.
- 6 Tap the thumbnail to start the transfer.
- 7 When the transfer is done, the music file plays immediately on the receiving device. At the same time, the file is saved on the receiving device.

To share a photo or video with another device using NFC

- 1 Make sure that both devices have the NFC function turned on, and that both screens are active.
- 2 To view photos and videos in your device, go to your Home screen, tap , then find and tap **Album**.
- 3 Tap the photo or video that you want to share.
- 4 Hold your device and the receiving device back to back so that the NFC detection areas of each device touch each other. When the devices connect, a thumbnail of the track appears.
- 5 Tap the thumbnail to start the transfer.
- 6 When the transfer is done, the photo or video is displayed on the screen of the receiving device. At the same time, the item is saved on the receiving device.

To share a web address with another device using NFC

- 1 Make sure that both devices have the NFC function turned on, and that both screens are active.
- 2 From your Home screen, tap .
- 3 To open the web browser, find and tap .
- 4 Load the web page that you want to share.
- 5 Hold your device and the receiving device back to back so that the NFC detection areas of each device touch each other. When the devices connect, a thumbnail appears.
- 6 Tap the thumbnail to start the transfer.
- 7 When the transfer is done, the web page is displayed on the screen of the receiving device.

Scanning NFC tags

Your device can scan various kinds of NFC tags. For example, it can scan embedded tags on a poster, on a billboard advertisement, or beside a product in a retail store. You can receive additional information, such as a web address.

To scan an NFC tag

- 1 Make sure that your device has the NFC function turned on and that the screen is active.
- 2 Place your device over the tag so that the NFC detection area touches it. Your device scans the tag and displays the content collected. Tap the content of the tag to open it.

Connecting to an NFC compatible device

You can connect your device to other NFC compatible devices produced by Sony, such as a speaker or a headphone. When establishing this kind of connection, refer to the User guide of the compatible device for more information.

- ! You may need to have Wi-Fi® or Bluetooth® activated on both devices for the connection to work.

Bluetooth® wireless technology

Use the Bluetooth® function to send files to other Bluetooth® compatible devices, or to connect to handsfree accessories. Bluetooth® connections work better within 10 metres (33 feet), with no solid objects in between. In some cases you have to manually pair your device with other Bluetooth® devices.

- ! Interoperability and compatibility among Bluetooth® devices can vary.
- ! If you are using a device with multiple users, each user can change the Bluetooth® settings, and the changes affect all users.

To turn on the Bluetooth® function

- 1 From your Home screen, tap .
- 2 Find and tap **Settings** > **Bluetooth**.
- 3 Tap the on-off switch beside **Bluetooth** so that the Bluetooth® function is turned on. Your device is now visible to nearby devices and a list of available Bluetooth® devices appears.

Naming your device

You can give your device a name. This name is shown to other devices after you have turned on the Bluetooth® function and your device is set to visible.

To give your device a name

- 1 Make sure that the Bluetooth® function is turned on.
- 2 From your Home screen, tap .
- 3 Find and tap **Settings** > **Bluetooth**.
- 4 Tap  > **Rename this device**.
- 5 Enter a name for your device.
- 6 Tap **Rename**.

Pairing with another Bluetooth® device

When you pair your device with another device, you can, for example, connect your device to a Bluetooth® headset or a Bluetooth® car kit and use these other devices to share music.

Once you pair your device with another Bluetooth® device, your device remembers this pairing. When pairing your device with a Bluetooth® device, you may need to enter a passcode. Your device will automatically try the generic passcode 0000. If this does not work, refer to the user guide for your Bluetooth® device to get the device passcode. You do not need to re-enter the passcode the next time you connect to a previously paired Bluetooth® device.

- ! Some Bluetooth® devices, for example, most Bluetooth® headsets, require you to both pair and connect with the other device.
- ! You can pair your device with several Bluetooth® devices, but you can only connect to one Bluetooth® profile at the same time.



To pair your device with another Bluetooth® device

- 1 Make sure that the device you want to pair with has the Bluetooth® function activated and is visible to other Bluetooth® devices.
- 2 From your device's Home screen, tap .
- 3 Find and tap **Settings** > **Bluetooth**.
- 4 Drag the slider beside **Bluetooth** to turn on the Bluetooth® function. A list of available Bluetooth® devices appears.
- 5 Tap the Bluetooth® device that you want to pair with.
- 6 Enter a passcode, if required, or confirm the same passcode on both devices.

To connect your device to another Bluetooth® device

- 1 From your Home screen, tap .
- 2 Find and tap **Settings** > **Bluetooth**.
- 3 Tap the Bluetooth® device to which you want to connect.

To unpair a Bluetooth® device

- 1 From your Home screen, tap .
- 2 Find and tap **Settings** > **Bluetooth**.
- 3 Under **Paired devices**, tap  beside the name of the device that you want to unpair.
- 4 Tap **Forget**.

Sending and receiving items using Bluetooth® technology

Share items with other Bluetooth® compatible devices such as phones or computers. You can send and receive several kinds of items using the Bluetooth® function, such as:

- Photos and videos
- Music and other audio files
- Contacts
- Web pages

To send items using Bluetooth®

- 1 **Receiving device:** Make sure the Bluetooth® function is turned on and that the device is visible to other Bluetooth® devices.
- 2 **Sending device:** Open the application which contains the item that you want to send, and scroll to the item.
- 3 Depending on the application and on the item that you want to send, you may need to, for example, touch and hold the item, open the item, and press . Other ways to send an item may exist.
- 4 Select **Bluetooth**.
- 5 Turn on Bluetooth® if you are asked to do so.
- 6 Tap the name of the receiving device.
- 7 **Receiving device:** If asked, accept the connection.
- 8 **Sending device:** If asked, confirm the transfer to the receiving device.
- 9 **Receiving device:** Accept the incoming item.

To receive items using Bluetooth®

- 1 Make sure that the Bluetooth® function is on and is visible to other Bluetooth® devices.
- 2 The sending device now starts sending data to your device.
- 3 If prompted, enter the same passcode on both devices, or confirm the suggested passcode.
- 4 When you are notified of an incoming file to your device, drag the status bar downwards and tap the notification to accept the file transfer.
- 5 Tap **Accept** to start the file transfer.
- 6 To view the progress of the transfer, drag the status bar downwards.
- 7 To open a received item, drag the status bar downwards and tap the relevant notification.

To view files you have received using Bluetooth®

- 1 From your Home screen, tap .
- 2 Find and tap **Settings** > **Bluetooth**.
- 3 Press  and select **Show received files**.

One-touch setup

You can use the One-touch setup function to automatically launch the setup of several features that work wirelessly between two Xperia™ devices. For example, you can use One-touch setup to launch the configuration of basic settings for Screen mirroring and Xperia Link™. Once you've completed the setup, you then only need one touch every time to launch these features.

The One-touch setup function is activated using NFC. For more information about setting up Screen mirroring, Media Server, NFC and Bluetooth® on your device, refer to the relevant sections of the User guide.

To start One-touch setup on your device

- 1 From your Home screen, tap .
 - 2 Find and tap **Settings** > **Xperia™ Connectivity** > **One-touch setup**. The NFC function is automatically turned on.
 - 3 Make sure the NFC function on the other Xperia™ device is turned on.
 - 4 Make sure the screens of both devices are unlocked and active.
 - 5 Hold the two devices together so that the NFC detection area of each device touches the other. The one-touch setup function launches automatically.
- ! Both devices must support the One-touch setup function.

Smart apps and features that save you time

Controlling accessories and settings with Smart Connect™

Use the Smart Connect™ application to set what happens in your device when you connect or disconnect an accessory. For example, you can decide to always start the FM radio application when you connect a headset.

You can also set Smart Connect™ to read out incoming text messages. Or you can use the application to set a specific action or a group of actions to launch on your device at certain times of the day. For example, when you connect your headset between 7am and 9am, you can decide that:

- The FM radio application starts.
- Your favourite social networking app opens, for example, Facebook.
- The ring volume is set to vibrate.

With Smart Connect™, you can also manage accessories such as Xperia™ SmartTags or a watch from the Sony SmartWatch series. Refer to the User guide of the specific accessory for more information.

- ! If you are using a device with multiple users, you must log in as the owner, that is, the primary user, to use the Smart Connect™ application.

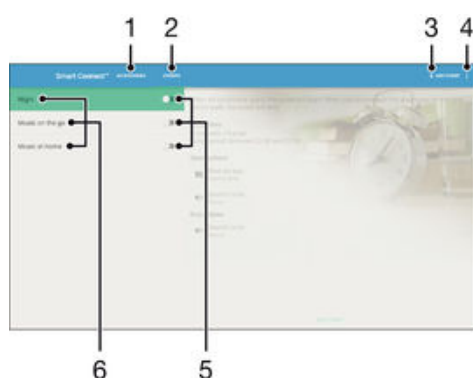

1 Tap to display available accessories

2 Tap to display all events



3 Add an accessory or an event

4 View menu options

5 Tap to activate an event

6 Tap to view details of an event

To create a Smart Connect™ event

- 1 From your Home screen, tap , then find and tap .
 - 2 If you are opening Smart Connect™ for the first time, tap **OK** to close the introduction screen.
 - 3 On the **Events** tab, tap **+**.
 - 4 If you are creating an event for the first time, tap **OK** again to close the introduction screen.
 - 5 Add conditions under which you want to trigger the event. A condition could be the connection with an accessory, or a specific time interval, or both.
 - 6 Tap **→** to continue.
 - 7 Add what you want to happen when you connect an accessory, and set other settings as desired.
 - 8 Tap **→** to continue.
 - 9 Set an event name, then tap **Finish**.
-  To add a Bluetooth® accessory, you have to first pair it with your device.

To edit a Smart Connect™ event

- 1 Start the Smart Connect™ application.
- 2 On the **Events** tab, tap an event.
- 3 If the event is switched off, drag the slider to the right to turn it on.
- 4 Tap **Edit event**, then adjust the settings as desired.

To delete an event

- 1 Start the Smart Connect™ application.
- 2 On the **Events** tab, touch and hold the event that you want to delete, then tap **Delete event**.
- 3 Tap **Delete** to confirm.

-  You can also open the event that you want to delete, then tap  > **Delete event** > **Delete**.

To set Smart Connect™ to read out incoming text messages

- 1 Start the Smart Connect™ application.
- 2 Tap , then tap **Settings**.
- 3 Mark the checkbox beside **Text to speech**, then confirm activation, if necessary.

-  If this feature is turned on, all incoming messages are read aloud. To protect your privacy, you may need to turn off this feature if you are using your device in a public place or at work, for example.

Managing accessories

Use the Smart Connect™ application to manage a range of smart accessories that you can connect to your device, including Xperia™ SmartTags, a SmartWatch series watch or a wireless headset from Sony. Smart Connect™ downloads any necessary applications and also finds third-party applications, when available. Previously connected accessories show in a list that allows you to get more information about the features of each accessory.

To pair and connect an accessory

- 1 Start the Smart Connect™ application. If you are opening Smart Connect™ for the first time, tap **OK** to close the introduction screen.
- 2 Tap **Accessories**, then tap **+**.
- 3 Turn on the Bluetooth® function if it is not already on, then tap the name of the accessory that you want to pair and connect with.
- 4 If required, enter a passcode, or confirm the same passcode on both your device and the accessory.

To adjust the settings for a connected accessory

- 1 Pair and connect the accessory with your device.
- 2 Start the Smart Connect™ application.
- 3 Tap **Accessories**, then tap the name of the connected accessory.
- 4 Adjust the desired settings.

Using your device as a fitness hub with ANT+™

You can use your device with health and fitness products that also support ANT+™ technology. For example, if you go running with an ANT+™ compatible heart rate monitor and a foot pod (to measure pace and distance), you can collect all the data from the run on your device. You can then analyse your performance and see how you can improve.

You can download a range of applications from Google Play™ that support ANT+™ sport, fitness and health devices. For information about ANT+™ compatible products, go to www.thisisant.com/directory.

Using your device as a wallet

Use your device as a wallet to pay for goods without reaching for your real wallet. All of your installed payment services are put together to be viewed and managed. Note that when making a payment, you must first turn on the NFC function before your device touches a card reader. For more information about NFC, see *NFC* on page 110 .

- ! Mobile payment services may not yet be available in all regions.

To manage payment services

- 1 From your Home screen, tap .
- 2 Find and tap **Settings** > **Tap & pay**. A list of payment services appears.
- 3 Manage the payment services as desired, for example, change your default payment service.

Travel and maps

Using location services

Location services allow applications such as Maps and the camera to use information from mobile and Wi-Fi® networks as well as Global Positioning System (GPS) information to determine your approximate location. If you're not within a clear line of sight to GPS satellites, your device can determine your location using the Wi-Fi® function. And if you're not within range of a Wi-Fi® network, your device can determine your location using your mobile network.

In order to use your device to find out where you are, you need to enable location services.

- ! You may incur data connection charges when you connect to the Internet from your device.

To enable or disable location services

- 1 From your Home screen, tap .
- 2 Find and tap **Settings** > **Location**, then tap the on-off switch accordingly to enable or disable location services.
- 3 If you selected to enable location services in step 2, tap **Agree** to confirm.

Improving GPS accuracy

The first time you use the GPS function in your device, it can take 5 to 10 minutes for your location to be found. To help the search, make sure you have a clear view of the sky. Stand still and don't cover the GPS antenna (the highlighted area in the image). GPS signals can pass through clouds and plastic, but not through most solid objects such as buildings and mountains. If your location isn't found after a few minutes, move to another location.

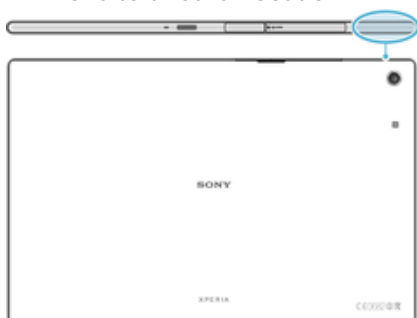

Google Maps™ and navigation

Use Google Maps™ to track your current location, view real-time traffic situations and receive detailed directions to your destination.

The Google Maps™ application requires an Internet connection when used online. You may incur data connection charges when you connect to the Internet from your device. To get more detailed information about how to use this application, go to <http://support.google.com> and click the "Maps for mobile" link.

- ! The Google Maps™ application may not be available in every market, country or region.

To use Google Maps™

- 1 From your Home screen, tap .
- 2 Find and tap **Maps**.

Using data traffic when travelling

When you travel outside of your home mobile network, you might need to access the Internet using mobile data traffic. In this case, you need to activate data roaming on

your device. It is recommended to check the relevant data transmission charges in advance.

- ! If you are using a device with multiple users, you may need to log in as the owner, that is, the primary user, to activate or deactivate data roaming.

To activate data roaming

- 1 From your Home screen, tap .
 - 2 Find and tap **Settings** > **More** > **Mobile networks**.
 - 3 Drag the slider beside **Data roaming** to the right.
- ! You can't activate data roaming when mobile data is turned off.

Using your device with a car infotainment system

Connect your device to a MirrorLink™ certified car infotainment system using a USB cable to, for example, use a navigation app or play music from your device while driving. When connected, you can navigate the apps using the car infotainment system controls.

- ! Some applications may not be available during MirrorLink™ connection. Also, protected data, such as videos that are strictly protected under Digital Rights Management (DRM), is not made available via MirrorLink™.



To connect your device to a car infotainment system

- Connect your device and the car infotainment system using a USB cable. The screen of your device appears on the screen of the infotainment system.
- ! You may need to start MirrorLink™ manually if the connection between your device and the infotainment system is not established automatically.

To start MirrorLink™ manually

- 1 Make sure that your device is connected to the car infotainment system using a USB cable.
- 2 From your Home screen, tap .
- 3 Find and tap **Settings** > **Xperia™ Connectivity** > **MirrorLink™**.
- 4 Tap **Start MirrorLink™**, then tap **OK**.
- 5 If the connection still fails, tap **Network address** to change to another network address in case the same network address is being used by other services such as Bluetooth® and Wi-Fi®, and then try again.

Airplane mode

In Airplane mode, the network and radio transceivers are turned off to prevent disturbance to sensitive equipment. However, you can still play games, listen to music, watch videos and other content, as long as all this content is saved on your

memory card or internal storage. You can also be notified by alarms, if alarms are activated.

- 💡 Turning on Airplane mode reduces battery consumption.

To turn on Airplane mode

- 1 From your Home screen, tap .
- 2 Find and tap **Settings** > **More**.
- 3 Drag the slider beside **Airplane mode** to the right.

Calendar and alarm clock

Calendar

Use the Calendar application to manage your time schedule. If you have signed into and synchronised your device with one or several online accounts that include calendars, for example, your Google™ account or Xperia™ with Facebook account, then calendar events from these accounts will also appear in the Calendar application. You can select which calendars you want to integrate into the combined Calendar view.

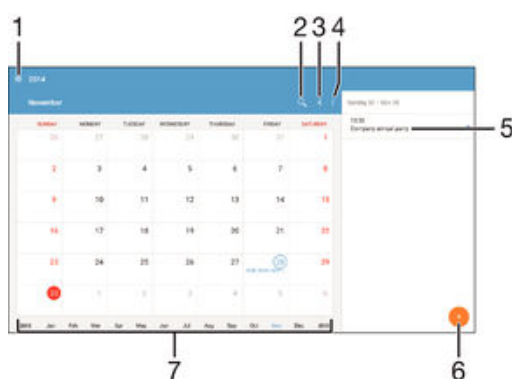

When an appointment time approaches, your device plays a notification sound to remind you. Also,  appears in the status bar.

- 💡 You can also synchronise your Outlook calendar with your device using PC Companion. If you do so, all appointments from your Outlook calendar will appear in the calendar view of your device.



- 1 Select a view type and the calendars that you want to view
- 2 Search for events
- 3 Return to the current date
- 4 Access settings and other options
- 5 Agenda for the selected day
- 6 Add a calendar event
- 7 Flick left or right to browse more quickly



To create a calendar event

- 1 From your Home screen, tap , then tap **Calendar**.
- 2 Tap .
- 3 If you have synchronised your calendar with one or more accounts, select the account to which you want to add this event. If you only want to add this event on your device, tap **Device calendar**.
- 4 Enter or select the desired information and add attendees to the event.
- 5 To save the event and send out invitations, tap **Save**.

To view a calendar event

- 1 From your Home screen, tap , then tap **Calendar**.
- 2 Tap the event that you want to view.



To view multiple calendars

- 1 From your Home screen, tap , then find and tap **Calendar**.
- 2 Tap , then mark the checkboxes for the calendars that you want to view.

To zoom the calendar view

- When the **Week** or the **Day** view is selected, pinch the screen to zoom in.



To display national holidays in the Calendar application

- 1 From your Home screen, tap , then tap **Calendar**.
- 2 Tap , then tap **Settings** > **Calendar view settings**.
- 3 Tap **National holidays**.
- 4 Select an option, or a combination of options, then tap **OK**.

To display birthdays in the Calendar application



- 1 From your Home screen, tap , then tap **Calendar**.
- 2 Tap , then tap **Settings** > **Calendar view settings**.
- 3 Tap **Birthdays**, then drag the slider beside **Birthdays** to the right.

To display weather forecasts in the Calendar application

- 1 From your Home screen, tap , then tap **Calendar**.
- 2 Tap , then tap **Settings** > **Calendar view settings**.
- 3 Tap **Weather forecast**, then drag the slider beside **Weather forecast** to the right.
- 4 If location services are disabled, tap **Home location**, then search for the city that you want to add.

- 💡 For more information about how to enable location services, see *Using location services* on page 118 .

To change weather forecast settings in the Calendar application

- 1 From your Home screen, tap , then tap **Calendar**.
- 2 Tap , then tap **Settings** > **Calendar view settings**.
- 3 Tap **Weather forecast**.
- 4 Adjust the settings as desired.

Alarm and clock



You can set one or several alarms and use any sound saved on your device as the alarm signal. The alarm does not sound if your device is turned off.

The alarm time format displayed is the same as the format you select for your general time settings, for example, 12-hour or 24-hour.



- 1 Access the alarm home screen
- 2 View a world clock and adjust settings
- 3 Access the stopwatch function
- 4 Access the timer function
- 5 View options
- 6 Turn an alarm on or off
- 7 Add a new alarm

To set a new alarm



- 1 From your Home screen, tap .
- 2 Find and tap **Alarm & clock**.
- 3 Tap .
- 4 Tap **Time** and select the desired value.
- 5 Tap **OK**.
- 6 If desired, edit other alarm settings.
- 7 Tap **Save**.

To snooze an alarm when it sounds

- Tap **Snooze**.

To turn off an alarm when it sounds

- Drag  to the right.

 To turn off a snoozed alarm, you can drag down the status bar to open the Notification panel and then tap .

To edit an existing alarm

- 1 Open the Alarm & clock application, then tap the alarm that you want to edit.
- 2 Make the desired changes.
- 3 Tap **Save**.

To turn on or off an alarm

- Open the Alarm & clock application, then drag the slider next to the alarm to the on or off position.

To delete an alarm

- 1 Open the Alarm & clock application, then touch and hold the alarm that you want to delete.
- 2 Tap **Delete alarm**, then tap **Yes**.

To set the sound for an alarm

- 1 Open the Alarm & clock application, then tap the alarm that you want to edit.
- 2 Tap **Alarm sound** and select an option, or tap  and select a music file.
- 3 Tap **Done**, then tap **Save**.

To adjust the volume level for an alarm

- 1 Open the Alarm & clock application, then tap the alarm that you want to edit.
- 2 Drag the volume slider under **Alarm volume** to the desired position.
- 3 Tap **Save**.

To set a recurring alarm

- 1 Open the Alarm & clock application, then tap the alarm that you want to edit.
- 2 Tap **Repeat**.
- 3 Mark the checkboxes for the relevant days, then tap **OK**.
- 4 Tap **Save**.

To activate the vibrate function for an alarm

- 1 Open the Alarm & clock application, then tap the alarm that you want to edit.
- 2 Mark the **Vibrate** checkbox.
- 3 Tap **Save**.

To set the side keys behaviour

- 1 Open the Alarm & clock application, then select the alarm that you want to edit.
- 2 Tap **Side keys behavior**, then select the desired behaviour of side keys when they are pressed during the alarm.
- 3 Tap **Save**.

Accessibility

Magnification gestures

Magnification gestures allow you to zoom in to parts of the screen by tapping an area of the touchscreen three times in succession.

To enable or disable Magnification gestures

- 1 From your Home screen, tap .
- 2 Find and tap **Settings** > **Accessibility** > **Magnification gestures**.
- 3 Tap the on-off switch.

To magnify an area and pan across the screen

- 1 Make sure that **Magnification gestures** is enabled.
- 2 Tap an area three times and then hold and drag your finger across the screen.

Large text

You can enable the Large text option to increase the default size of text displayed on your device.

To enable or disable Large text

- 1 From your Home screen, tap .
- 2 Find and tap **Settings** > **Accessibility**.
- 3 Drag the slider next to **Large text**.

Colour correction

The Colour correction setting adjusts how colours are displayed on the screen for users who are colour blind or have difficulty distinguishing between colours.

To enable Colour correction

- 1 From your Home screen, tap .
- 2 Find and tap **Settings** > **Accessibility** > **Colour correction**.
- 3 Tap the on-off switch.
- 4 Tap **Correction mode**, then select the appropriate colour sensitivity.

! Colour correction is currently an experimental feature and may affect device performance.

TalkBack

TalkBack is a screen reader service for visually impaired users. TalkBack uses spoken feedback to describe any events or actions performed on your Android device. TalkBack describes the user interface and reads out software errors, notifications and messages.

To enable TalkBack

- 1 From your Home screen, tap .
- 2 Find and tap **Settings** > **Accessibility** > **TalkBack**.
- 3 Tap the on-off switch and then tap **OK**.

! To change speech, feedback and touch preferences for TalkBack, tap **Settings**.

💡 TalkBack launches a tutorial immediately after you enable the feature. To exit the tutorial, tap the **Exit** button twice.

To disable TalkBack



- 1 From your Home screen, double-tap .
- 2 Find and double-tap **Settings** > **Accessibility** > **TalkBack**.
- 3 Double-tap the on-off switch and then double-tap **OK**.

Support and maintenance

Support for your device

Use the Support application in your device to search a User guide, read troubleshooting guides, and find information about software updates and other product-related information.

To access the Support application

- 1 From your Home screen, tap .
 - 2 Find and tap , then select the required support item.
- ! Make sure that you have a working Internet connection, preferably over Wi-Fi®, to limit data traffic charges when using the Support application.

Help in menus and applications

Some applications and settings have help available in the options menu, which is normally indicated by  in the specific applications.

Help us improve our software

You can enable the sending of usage info from your device so that Sony Mobile can receive anonymous bug reports and statistics that help improve our software. None of the information gathered includes personal data.

To allow the sending of usage info

- 1 From your Home screen, tap .
- 2 Find and tap **Settings** > **About tablet** > **Usage info settings**.
- 3 Mark the **Send usage info** checkbox if it is not already marked.
- 4 Tap **Agree**.

Computer tools

There are a number of tools available to help you connect your device to a computer and manage content such as contacts, movies, music and photos.

PC Companion for Microsoft® Windows®

PC Companion is a computer application that gives you access to additional features and services which help you to:

- Transfer contacts, music, video and pictures to and from your old device.
- Transfer content from your old iPhone™, Blackberry™, Android™ or Sony device using Xperia™ Transfer.
- Update your device software.
- Back up content on your computer.
- Sync calendars between a computer and your device.

To use the PC Companion application, you need an Internet-connected computer running one of the following operating systems:

- Microsoft® Windows® 10
- Microsoft® Windows® 8.1
- Microsoft® Windows® 7
- Microsoft® Windows Vista®
- Microsoft® Windows® XP (Service Pack 3 or higher)

You can download PC Companion at <http://support.sonymobile.com/global-en/tools/pc-companion>.

Media Go™ for Microsoft® Windows®

The Media Go™ application for Windows® computers helps you transfer photos, videos and music between your device and a computer. You can install and access Media Go™ from within the PC Companion application. To read more about how to use the Media Go™ application, go to <http://mediago.sony.com/enu/features>.

To use the Media Go™ application, you need one of these operating systems:

- Microsoft® Windows® 8 / 8.1
- Microsoft® Windows® 7
- Microsoft® Windows Vista®

Sony Bridge for Mac

Sony Bridge for Mac is a computer application that gives you access to additional features and services which help you to:

- Transfer contacts, music, video and pictures to and from your old device.
- Transfer content from your old iPhone™, Blackberry™, Android™ or Sony device using Xperia™ Transfer.
- Update your device software.
- Transfer media files between your device and an Apple® Mac® computer.
- Back up content on an Apple® Mac® computer.

To use the Sony Bridge for Mac application, you must have an Internet-connected Apple® Mac® computer that runs Mac OS version 10.6 or later. You can download Sony Bridge for Mac at <http://support.sonymobile.com/global-en/tools/bridge-for-mac/>.

Updating your device

You should update the software on your device to get the latest functionality, enhancements and bug fixes in order to ensure optimal performance. When a software update is available,  appears in the status bar. You can also check for new updates manually.

The easiest way to install a software update is to do it wirelessly from your device. However, some updates are not available for wireless download. You then need to use the PC Companion application on a PC or the Sony Bridge for Mac application on an Apple® Mac® computer to update your device.

For more information about software updates, go to www.sonymobile.com/update.

- ! If you are using a device with multiple users, you must log in as the owner, that is, the primary user, to update the device.
- ! Insufficient remaining storage capacity may prevent updates. Ensure you have sufficient storage capacity before attempting to update.

To check for new software

- 1 If you are using a device with multiple users, make sure you are logged in as the owner.
 - 2 From your Home screen, tap .
 - 3 Find and tap **Settings** > **About tablet** > **Software update**.
- ! If no new software is available, it's possible that you may not have enough free memory on your device. If your Xperia™ device has less than 500 MB of free internal memory (device memory) available, you do not receive any information about new software. The following notification appears in the Notification panel to warn of the lack of storage space: Storage space running out. Some system functions may not work. If you receive this notification, you must free up internal memory (device memory) before you can get notifications about new software being available.

To download and install a system update

- 1 If you are using a device with multiple users, make sure you are logged in as the owner.
- 2 From your Home screen, tap .
- 3 Find and tap **Settings** > **About tablet** > **Software update**.
- 4 If a system update is available, tap **Download** to download it to your device.
- 5 When the download is finished, tap **Install** and follow the on-screen instructions to complete the installation.

To download and install a system update from the Notification panel

- 1 If you are using a device with multiple users, make sure you are logged in as the owner.
- 2 Drag the status bar downwards to open the Notification panel.
- 3 Scroll down and select the desired system update, then tap **Download**.
- 4 When the download is finished, open the Notification panel again if it is closed, then tap **Install** and follow the on-screen instructions to complete the installation.

Updating your device using a computer

You can download and install software updates on your device using a computer with an Internet connection. You need a USB cable and a PC running the PC Companion application or an Apple® Mac® computer running the Sony Bridge for Mac application.

- 💡 If you don't have the PC Companion or the Sony Bridge for Mac application installed on the relevant computer, connect your device to the computer using a USB cable and follow the on-screen installation instructions.

To update your device using a computer

- 1 Make sure you have the PC Companion application installed on your PC or the Sony Bridge for Mac application installed on the Apple® Mac® computer.
- 2 Using a USB cable, connect your device to the computer.
- 3 **Computer:** Launch the PC Companion application or the Sony Bridge for Mac application. After a few moments, the computer detects your device and searches for new software.
- 4 **Computer:** If a new software update is detected, a popup window appears. Follow the on-screen instructions to run the relevant software updates.

Finding a lost device



If you have a Google™ account, the my Xperia web service can help you locate and secure your device if you ever lose it. You can:

- Locate your device on a map.
 - Sound an alert even if the device is in silent mode.
 - Remotely lock the device and make the device display your contact information to anyone who finds it.
 - As a last resort, remotely clear the internal and external memory of the device.
- ! The my Xperia service may not be available in all countries/regions.

To activate the my Xperia service

- 1 From your Home screen, tap .
 - 2 Find and tap **Settings** > **Security** > **Protection by my Xperia** > **Activate**.
 - 3 Mark the checkbox, then tap **Accept**.
 - 4 If prompted, sign in to your Sony Entertainment Network account, or create a new one if you don't have one.
 - 5 Enable location services on your device if this function is not already enabled.
- ! To verify that the my Xperia service can locate your device, go to myxperia.sonymobile.com and sign in using either the Google™ account or the Sony Entertainment Network account that you have set up on your device.
- ! If you are using a device with multiple users, my Xperia service can only be used by the owner.

Finding the identification number of your device

Your device has a unique ID (identification) number. In your device, this number is referred to as the IMEI (International Mobile Equipment Identity). You should keep a copy of this number. You may require it, for example, when you access the Xperia™ Care support service and need to register your device. Also, if your device is stolen, some network providers can use this number to stop the device from accessing the network in your country.

To view your IMEI number

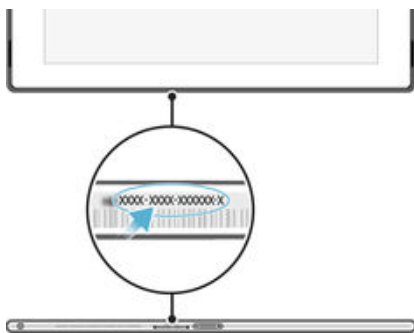

To view your IMEI number via the device settings

- 1 From your Home screen, tap .
 - 2 Find and tap **Settings** > **About tablet** > **Status** > **IMEI information**.
- 💡 To view the IMEI number, you can also open the phone dialer on your device and enter ***#06#**.

Memory and storage

Your device has different types of memory and storage options.

- The internal storage is about **12 GB** and is used to store downloaded or transferred content along with personal settings and data. Some examples of data stored to the internal storage are alarm, volume and language settings; emails; bookmarks; calendar events; photos; videos and music.
 - You can use a removable memory card with a storage capacity of up to **128 GB** to get more storage space. Media files and some apps (with their data) can be moved to this type of memory to free up internal storage. Some apps, for example, the Camera app, can save data directly to a memory card.
 - The dynamic memory (RAM) is about **3 GB** and cannot be used for storage. RAM is used to handle running applications and the operating system.
- ! You may have to purchase a memory card separately.
- 💡 Read more about the use of memory in Android devices by downloading the White paper for your device at www.sonymobile.com/support.

Improving memory performance

The memory in your device tends to fill up as a result of normal usage. If the device starts to slow down, or applications suddenly shut down, you should consider the following:

- Always have more than **100 MB** of free internal storage and more than **100 MB** of free RAM available.
 - Close down running applications that you are not using.
 - Clear the cache memory for all applications.
 - Uninstall downloaded applications that you don't use.
 - Move applications to the memory card if the internal storage is full.
 - Transfer photos, videos and music from the internal memory to the memory card.
 - If your device can't read content on the memory card, you may need to format the card. Note that all content on the card gets erased when you format it.
- ! If you are using a device with multiple users, you must log in as the owner, that is, the primary user, to be able to perform certain actions such as transferring data to the memory card and formatting the memory card.

To view the memory status

- 1 From your Home screen, tap .
- 2 Find and tap **Settings > Storage**.

To view the amount of free and used RAM

- 1 From your Home screen, tap .
- 2 Find and tap **Settings > Apps > Running**.

To clear the cache memory for all applications

- 1 From your Home screen, tap .
- 2 Find and tap **Settings > Storage**.
- 3 Tap **Cached data > OK**.

- ! When you clear the cache memory, you don't lose any important information or settings.

To transfer media files to the memory card

- 1 Make sure you have a memory card inserted in your device.
- 2 From your Home screen, tap .
- 3 Find and tap **Settings > Storage > Transfer data to SD card**.
- 4 Mark the file types that you want to transfer to the memory card.
- 5 Tap **Transfer**.

To move apps to the memory card

- 1 Make sure that you have a memory card inserted in your device.
- 2 From your Home screen, tap .
- 3 Find and tap **Settings > Apps**.
- 4 Swipe across to the **On SD card** tab. A list appears showing the apps that can be moved.
- 5 Select the app that you want to move, then tap **MOVE TO SD CARD**. After the app is moved, a marked checkbox appears beside the app.

To stop applications and services from running

- 1 From your Home screen, tap .
- 2 Find and tap **Settings > Apps > Running**.
- 3 Select an application or service, then tap **STOP**.

To format the memory card

- 1 From your Home screen, tap .
- 2 Find and tap **Settings > Storage > Erase SD card**.
- 3 To confirm, tap **Erase SD card > Erase everything**

- ! All content on the memory card gets erased when you format it. Make sure you make backups of all data that you want to save before formatting the memory card. To back up your content,

you can copy it to a computer. For more information, see *Managing files using a computer* on page 132 .

Managing files using a computer

Use a USB cable connection between a Windows® computer and your device to transfer and manage your files. Once the two devices are connected, you can drag and drop content between your device and the computer, or between your device's internal storage and SD card, using the computer's file explorer.

If you have an Apple® Mac® computer, you can use the Sony Bridge for Mac application to access the file system of your device. You can download Sony Bridge for Mac from <http://support.sonymobile.com/global-en/tools/bridge-for-mac/>.

- 💡 If you're transferring music, video, pictures or other media files to your device, use the Media Go™ application on your Windows® computer. Media Go™ converts media files so that you can use them on your device. To learn more and download the Media Go™ application, go to <http://mediago.sony.com/enu/features>.

USB Connection Modes

There are two USB connection modes available for you to use:

Media transfer mode (MTP)	Use MTP for managing files, updating device software and connecting via WLAN. This USB mode is used with Microsoft® Windows® computers. MTP is enabled by default.
Mass storage mode (MSC)	Use MSC for managing files using MAC OS® and Linux computers that don't have MTP support.

To change USB connection mode

- 1 From your Home screen , tap .
- 2 Find and tap **Settings > Xperia™ Connectivity > USB Connectivity > USB connection mode**.
- 3 Tap **Media transfer mode (MTP)** or **Mass storage mode (MSC)**.
- 4 Tap **OK**.

Transferring files using Media transfer mode via Wi-Fi®

You can transfer files between your device and other MTP compatible devices, such as a computer, using a Wi-Fi® connection. Before connecting, you first need to pair the two devices. If you're transferring music, video, pictures or other media files between your device and a computer, it's best to use the Media Go™ application on the computer. Media Go™ converts media files so that you can use them on your device.

- 💡 In order to use this feature, you need a Wi-Fi® enabled device that supports Media transfer, for example, a computer running Microsoft® Windows Vista® or Windows® 7.

To prepare to use your device wirelessly with a computer

- 1 Make sure Media transfer mode is enabled on your device. It is normally enabled by default.
- 2 Make sure the Wi-Fi® function is turned on.
- 3 From your Home screen, tap .
- 4 Find and tap **Settings > Xperia™ Connectivity > USB Connectivity**.
- 5 Tap **Pair with PC**, then tap **Next**.
- 6 Follow the on-screen instructions to complete the setup process.

To connect wirelessly to a paired device

- 1 Make sure Media transfer mode is enabled on your device. It is normally enabled by default.
- 2 Make sure the Wi-Fi® function is turned on.
- 3 From your Home screen, tap .
- 4 Find and tap **Settings** > **Xperia™ Connectivity** > **USB Connectivity**.
- 5 Select the paired device to which you want to connect, then tap **Connect**.

To disconnect from a paired device

- 1 From your Home screen, tap .
- 2 Find and tap **Settings** > **Xperia™ Connectivity** > **USB Connectivity**.
- 3 Select the paired device that you want to disconnect.
- 4 Tap **Disconnect**.

To remove a pairing with another device

- 1 From your Home screen, tap .
- 2 Find and tap **Settings** > **Xperia™ Connectivity** > **USB Connectivity**.
- 3 Select the paired device that you want to remove.
- 4 Tap **Unpair**.

Backing up and restoring content

Generally, you should not save photos, videos and other personal content solely on the internal memory of your device. If something should happen with the hardware, or if your device is lost or stolen, the data stored on its internal memory is gone forever. It is recommended to use the PC Companion or the Sony Bridge for Mac applications to make backups which save your data safely to a computer, that is, an external device. This method is especially recommended if you are updating your device software from one Android version to another, for example, from Android version 4.4 to 5.0.

Once your data is safely backed up to a computer, you can also make a quick backup of basic settings and data to the SD card in your device or to an external USB storage device by using the Backup & Restore application.

- ! It is very important that you remember the password that you set when you make a data backup. If you forget the password, it may not be possible to restore important data such as contacts and messages.

Backing up data to a computer

Use the PC Companion application or the Sony Bridge for Mac application to back up data from your device to a PC or an Apple® Mac® computer. These backup applications let you back up the following types of data:

- Contacts and call logs
- Text messages
- Bookmarks
- Calendar data
- Settings
- Media files such as music and videos
- Photos and images

To back up your data using a computer

- 1 Make sure that the PC Companion application is installed on the PC or the Sony Bridge for Mac application is installed on the Apple® Mac® computer.
- 2 Connect your device to the computer using a USB cable.
- 3 **Computer:** Open the PC Companion application or the Sony Bridge for Mac application.
- 4 Click **Start** to start the *Backup & Restore* application.
- 5 Tap **Backup**, then follow the on-screen instructions to back up data from your device.

To restore your data using a computer

- 1 Make sure that the PC Companion application is installed on the PC or the Sony Bridge for Mac application is installed on the Apple® Mac® computer.
- 2 Connect your device to the computer using a USB cable.
- 3 **Computer:** Open the PC Companion application or the Sony Bridge for Mac application.
- 4 Click **Start** to start the *Backup & Restore* application.
- 5 Select a backup file from the backup records, then tap **Restore** and follow the on-screen instructions to restore data to your device.

Backing up data with the Backup & Restore application

Using the Backup & Restore application, you can back up data manually or turn on the automatic backup function to save data periodically.

The Backup & Restore application is recommended for backing up data before you do a factory data reset. With this application you can back up the following types of data to an SD card or to an external USB storage device that you have connected by the USB Host adapter to your device:

- Bookmarks
- System settings
- Contacts
- Conversations
- Calendar data
- Media files

- ! Depending on the version of the Backup & Restore application that's installed on your device, you may not be able to back up and restore data between different Android versions, for example, when updating from Android version 4.4 to version 5.0. However, if you are running version 1.1 (or later) of the Backup & Restore application, you can restore your data between such updates. You can check the version of the Backup & Restore application under **Settings > Apps > All > Backup & restore**.

To back up content using the Backup and restore application

- 1 If you are backing up content to a USB storage device, make sure the storage device is connected to your device using the appropriate cable. If you are backing up to an SD card, make sure the SD card is properly inserted in your device.
- 2 From your Home screen, tap .
- 3 Find and tap **Backup & Restore**.
- 4 Tap **Back up**, then select a backup destination and the data types that you want to back up.
- 5 Tap **Back up now**.
- 6 Enter a password for the backup, then tap **OK**.

To restore content using the Backup and restore application

- 1 If you are restoring content from a USB storage device, make sure the storage device is connected to your device using the appropriate cable. If you are restoring content from an SD card, make sure the SD card is properly inserted in your device.
 - 2 From your Home screen, tap .
 - 3 Find and tap **Backup & Restore**.
 - 4 Tap **Restore**.
 - 5 Select the record that you want to restore from, then tap **Restore now**.
 - 6 Enter the password for the backup record, then tap **OK**.
- ! Remember that any changes you make to your data and settings after you create a backup will get deleted during a restore procedure.

Running diagnostic tests on your device

The Xperia™ Diagnostics application can test a specific function or run a full diagnostic test to check if your Xperia™ device is working properly.

Xperia™ Diagnostics can:

- Assess potential hardware or software issues on your Xperia™ device.
 - Analyse how well applications perform on your device.
 - Log the number of dropped calls during the previous 10 days.
 - Identify installed software and provide useful details about your device.
- 💡 The Xperia™ Diagnostics application is pre-installed on most Android™ devices from Sony. If the Diagnostics option is not available under **Settings > About tablet**, you can download a light version from Google Play™.

To run a specific diagnostic test

- 1 From your Home screen, tap .
- 2 Find and tap **Settings > About tablet > Diagnostics > Test**.
- 3 Select a test from the list.
- 4 Follow the instructions and tap **Yes** or **No** to confirm if a feature works.

To run all diagnostic tests

- 1 From your Home screen, tap .
- 2 Find and tap **Settings > About tablet > Diagnostics > Test > Run all**.
- 3 Follow the instructions and tap **Yes** or **No** to confirm if a feature works.



To view details about your device

- 1 From your Home screen, tap .
- 2 Find and tap **Settings > About tablet > Diagnostics > Facts**.

Resetting your applications

You can reset an application or clear application data if your application stops responding or causes issues with your device.

To reset application preferences

- 1 From your Home screen, tap .
 - 2 Find and tap **Settings > Apps**.
 - 3 Tap , then tap **Reset app preferences**.
- ! Resetting application preferences does not delete any application data from your device.

To clear application data

- 1 From your Home screen, tap .
 - 2 Find and tap **Settings > Apps** and then swipe over to the **All** tab.
 - 3 Select an application or service, then tap **CLEAR DATA**.
- ! When you clear application data, data for the selected application is deleted from your device permanently.
- ! The option to clear application data is not available for all applications or services.

To clear application cache

- 1 From your Home screen, tap .
 - 2 Find and tap **Settings > Apps** and then swipe over to the **All** tab.
 - 3 Select an application or service, then tap **CLEAR CACHE**.
- ! The option to clear the application cache is not available for all applications or services.

To clear the application default setting

- 1 From your Home screen, tap .
 - 2 Find and tap **Settings** > **Apps** and then swipe over to the **All** tab.
 - 3 Select an application or service, then tap **CLEAR DEFAULTS**.
- ! The option to clear the application default setting is not available for all applications or services.

Restarting and resetting your device

You can force your device to restart or shut down in situations where it stops responding or won't restart normally. No settings or personal data get deleted.

You can also reset your device to its original factory settings, with or without deleting some of your personal data, such as music and pictures. This action is sometimes necessary if your device stops functioning properly, but note that if you want to keep any important data, you have to first back up this data to a memory card or other non-internal memory. For more information, see *Backing up and restoring content* on page 133 .

If your device fails to power on or you want to reset your device's software, you can use PC Companion or Bridge for Mac to repair your device. For more information on using PC Companion or Bridge for Mac, see *Computer tools*.

- ! Your device may fail to restart if the battery level is low. Connect your device to a charger and try restarting again.
- ! If you are using a device with multiple users, you may need to log in as the owner, that is, the primary user, to reset your device to its original factory settings.

To force your device to restart

- 1 Press and hold down the power key .
- 2 In the menu that opens, tap **Restart**. The device restarts automatically.

To force the device to shut down

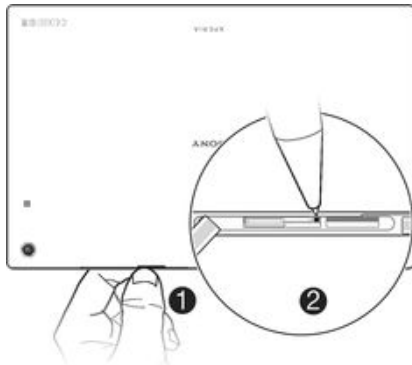

- 1 Remove the cover of the memory card slot.
 - 2 Using the tip of a pen or a similar object, press the OFF button.
- ! Do not use overly sharp objects that could damage the OFF button.

To perform a factory data reset

- ! To avoid permanent damage to your device, do not restart your device while a reset procedure is underway.

- 1 Before you start, make sure to back up any important data that is saved on the internal memory of your device to a memory card or other non-internal memory.
 - 2 From your Home screen, tap .
 - 3 Find and tap **Settings > Backup & reset > Factory data reset**.
 - 4 To delete information, such as music and pictures, from your internal storage, mark the relevant checkbox.
 - 5 Tap **Reset tablet**.
 - 6 If required, draw your screen unlock pattern, or enter your screen unlock password or PIN to continue.
 - 7 To confirm, tap **Erase everything**.
- ! Your device does not revert to an earlier software version of Android™ even if you perform a factory data reset.
- 💡 If you forget your screen unlock password, PIN or pattern in step 6, you can use the device repair feature in the PC Companion or Sony Bridge for Mac applications to erase this security layer. By running the repair feature, you are reinstalling software for your device and you may lose some personal data in the process.

To reinstall the device software using PC Companion

- 1 Make sure that PC Companion is installed on your PC.
- 2 Open the PC Companion application on the PC, then, under **Support Zone**, click **Start**.
- 3 Under **Phone / Tablet Software Update**, click **Start**.
- 4 Using the micro USB cable that came with your device, connect the device to your PC and then click **repair my phone / tablet**.
- 5 Follow the instructions that appear on the screen to reinstall the software and complete the repair.

To reinstall the device software using the Sony Bridge for Mac application

- 1 Make sure that *Sony Bridge for Mac* is installed on the Mac computer.
- 2 Open the Sony Bridge for Mac application and using the micro USB cable that came with your device, connect the device to your Mac computer.
- 3 Click **Xperia™ > Repair Xperia™ device > Continue**.
- 4 Follow the instructions that appear on the screen to reinstall the software and complete the repair.

Using your device in wet and dusty conditions

- ! To ensure the water resistance of your device, all covers, including the covers for the micro USB port, the SIM card slot and the memory card slot, must be firmly closed.

Your smart device is waterproof and dust resistant in compliance with the Ingress Protection (IP) ratings IP55 and IP58, as explained in the table below. To view more specific IP information about your device, go to www.sonymobile.com/global-en/legal/testresults/ and click on the relevant device name.

These specific IP ratings mean that your device is dust resistant and is protected against low pressure water stream as well as against the effects of immersion for 30 minutes in fresh (non-saline) water up to 1.5 metres deep.

You can use your device:

- in dusty environments, for example, on a windy beach.
- when your fingers are wet.
- in some extreme weather conditions, for example, when it's snowing or raining.
- in fresh (non-saline) water depths of 1.5 metres or less, for example, in a fresh water lake or river.
- in a chlorinated swimming pool.

Even if your device is resistant to dust and water, you should avoid exposing it unnecessarily to environments with excessive dust, sand and mud or to moist environments with extreme high or low temperatures. The waterproof ability of the

micro USB port, the SIM card slot, the memory card slot and the headset jack cannot be guaranteed in all environments or conditions.

Never immerse your device in salt water or let the micro USB port or headset jack come in contact with salt water. For example, if you're at the beach, remember to keep your device away from the sea water. Also, never expose the device to any liquid chemicals. For example, if you're washing dishes by hand using liquid detergent, avoid bringing your device in contact with the detergent. After exposure to non-fresh water, rinse your device using fresh water.

Normal wear and tear along with damage to your device can reduce its ability to resist dust or moisture. After using the device in water, dry off the areas around all covers, including the covers for the micro USB port, the SIM card slot and the memory card slot.

If the speaker or microphone get wet, their function may be impacted until the water has completely dried. Please note that the drying time can be up to three hours depending on the environment. During this time, you can, however, use other features in the device that do not utilise the speaker or microphone. All compatible accessories, including batteries, chargers, handsfree devices and micro USB cables, are not waterproof and dust resistant on their own.

Your warranty does not cover damage or defects caused by abuse or improper use of your device (including use in environments where the relevant IP rating limitations are exceeded). If you have any further questions about the use of your products, refer to our Customer support service for help. Also, for warranty information, refer to the *Important information* which can be accessed via the Setup guide in your device.

IP (Ingress Protection) rating

Your device has an IP rating, which means it has undergone certified tests to measure its resistance levels to both dust and water. The first digit in the two-digit IP rating indicates the level of protection against solid objects, including dust. The second digit indicates how resistant the device is to water.

Resistance to solid objects and dust	Resistance to water
IP0X: No special protection	IPX0: No special protection
IP1X: Protected against solid objects > 50 mm in diameter	IPX1: Protected against dripping water
IP2X: Protected against solid objects > 12.5 mm in diameter	IPX2: Protected against dripping water when tilted up to 15 degrees from normal position
IP3X: Protected against solid objects > 2.5 mm in diameter	IPX3: Protected against spraying water
IP4X: Protected against solid objects > 1 mm in diameter	IPX4: Protected against splashing water
IP5X: Protected against dust; limited ingress (no harmful deposit)	IPX5: Protected against water jet spray for at least 3 minutes
IP6X: Dust tight	IPX6: Protected against heavy jet spray for at least 3 minutes
	IPX7: Protected against the effects of immersion in up to 1 metre of water for 30 minutes
	IPX8: Protected against the effects of continued immersion in water depths greater than 1 metre. The exact conditions are specified for each device by the manufacturer.

! For more information, go to www.sonymobile.com/global-en/legal/testresults/.

Recycling your device

Got an old device lying around the house? Why not recycle it? By doing so, you will help us reuse its materials and components, and you'll protect the environment, too!

Find out more about the recycling options in your region at www.sonymobile.com/recycle.

Limitations to services and features

Some of the services and features described in this User guide are not supported in all countries/regions or by all networks and/or service providers in all areas. Without limitation, this applies to the GSM International Emergency Number, 112. Please contact your network operator or service provider to determine availability of any specific service or feature and whether additional access or usage fees apply.

Use of certain features and applications described in this guide may require access to the Internet. You may incur data connection charges when you connect to the Internet from your device. Contact your wireless service provider for more information.

Legal information

Sony SGP521

This User guide is published by Sony Mobile Communications Inc. or its local affiliated company, without any warranty. Improvements and changes to this User guide necessitated by typographical errors, inaccuracies of current information, or improvements to programs and/or equipment, may be made by Sony Mobile Communications Inc. at any time and without notice. Such changes will, however, be incorporated into new editions of this User guide. All illustrations are for illustration purposes only and may not accurately depict the actual device.

All product and company names mentioned herein are the trademarks or registered trademarks of their respective owners. All other trademarks are property of their respective owners. Any rights not expressly granted herein are reserved. Visit www.sonymobile.com/us/legal for more information.

This User guide may reference services or applications provided by third parties. Use of such programming or services may require separate registration with the third party provider and may be subject to additional terms of use. For applications accessed on or through a third-party website, please review such websites' terms of use and applicable privacy policy in advance. Sony does not warrant or guarantee the availability or performance of any third-party websites or offered services.

Your mobile device has the capability to download, store and forward additional content, for example, ringtones. The use of such content may be restricted or prohibited by rights of third parties, including but not limited to restriction under applicable copyright laws. You, and not Sony, are entirely responsible for additional content that you download to or forward from your mobile device. Prior to your use of any additional content, please verify that your intended use is properly licensed or is otherwise authorized. Sony does not guarantee the accuracy, integrity or quality of any additional content or any other third party content. Under no circumstances will Sony be liable in any way for your improper use of additional content or other third party content.

Visit www.sonymobile.com for more information.

This product is protected by certain intellectual property rights of Microsoft. Use or distribution of such technology outside of this product is prohibited without a licence from Microsoft.

Content owners use Windows Media digital rights management technology (WMDRM) to protect their intellectual property, including copyrights. This device uses WMDRM software to access WMDRM-protected content. If the WMDRM software fails to protect the content, content owners may ask Microsoft to revoke the software's ability to use WMDRM to play or copy protected content. Revocation does not affect unprotected content. When you download licences for protected content, you agree that Microsoft may include a revocation list with the licences. Content owners may require you to upgrade WMDRM to access their content. If you decline an upgrade, you will not be able to access content that requires the upgrade.

This product is licensed under the MPEG-4 visual and AVC patent portfolio licences for the personal and non-commercial use of a consumer for (i) encoding video in compliance with the MPEG-4 visual standard ("MPEG-4 video") or the AVC standard ("AVC video") and/or (ii) decoding MPEG-4 or AVC video that was encoded by a consumer engaged in a personal and non-commercial activity and/or was obtained from a video provider licensed by MPEG LA to provide MPEG-4 and/or AVC video. No licence is granted or shall be implied for any other use. Additional information including that relating to promotional, internal and commercial uses and licensing may be obtained from MPEG LA, L.L.C. See www.mpegla.com. MPEG Layer-3 audio decoding technology licensed from Fraunhofer IIS and Thomson.

SONY MOBILE WILL NOT BE LIABLE FOR ANY LOSS, ERASE AND/OR DATA-OVERWRITING OF PERSONAL DATA OR FILES STORED ON YOUR DEVICE (INCLUDING BUT NOT LIMITED TO CONTACTS, MUSIC TRACKS AND PICTURES) ARISING OUT OF ANY UPDATE OF YOUR DEVICE BY ANY OF THE METHODS DESCRIBED IN THIS USER GUIDE OR DOCUMENTATION. IN NO EVENT SHALL SONY MOBILE'S OR ITS SUPPLIERS' TOTAL LIABILITY TO YOU FOR ANY AND ALL DAMAGES, LOSSES AND CAUSES OF ACTION (WHETHER IN CONTRACT OR TORT, INCLUDING, BUT NOT LIMITED TO NEGLIGENCE OR OTHERWISE) EXCEED THE AMOUNT ACTUALLY PAID BY YOU FOR YOUR DEVICE.

© 2015 Sony Mobile Communications Inc.
All rights reserved.