



GENERATION FUTURE

SPIRIT



USER INSTRUCTIONS

IMPORTANT SAFETY REMINDERS

User's manual - This cleaner should only be used for its intended purpose as described in these instructions. Ensure that these are fully understood before operating this appliance.

Only use attachments recommended or supplied by Hoover.

When using cleaning tools, ensure that the cleaner is kept in the upright (parked) position. This will avoid possible damage to the carpet or floor covering. When cleaning stairs, DO NOT position the cleaner above you.

STATIC ELECTRICITY. Some carpets can cause a small build up of static electricity. Any static discharge is not hazardous to health.

DO NOT use your cleaner out of doors or on any wet surface or for wet pick up.

Keep hands, feet, loose clothing and hair away from rotating brushes.

DO NOT pick up hard or sharp objects, matches, hot ashes, cigarette ends or other similar items.

DO NOT pick up flammable liquids such as cleaning fluids, petrol, etc or their vapours.

Aerosol sprays may be flammable. DO NOT spray near cleaner.

SUPPLY CORD. DO NOT run over the supply cord when using your cleaner or remove the plug by pulling on the supply cord.

FAULTS. DO NOT continue to use your cleaner if it appears to be faulty. If the supply cord is damaged stop using the cleaner IMMEDIATELY. The supply cord must be replaced by an authorised Hoover service engineer to avoid a safety hazard.

AFTER USE. Switch the cleaner off and remove the plug from the electricity supply. Always switch off and remove the plug before cleaning the appliance or attempting any maintenance task.

Safety with children, elderly or the infirm: This appliance is not intended for use by persons (including children) with reduced physical, sensory or mental capabilities, or lack of experience and knowledge, unless they have been given supervision or instruction concerning use of the appliance by a person responsible for their safety. Children should be supervised to ensure that they do not play with the appliance.

HOOVER SERVICE. To ensure the continued safe and efficient operation of this appliance we recommend that any servicing or repairs are only carried out by an authorised Hoover service engineer.

Congratulations on the purchase of your new Hoover Spirit

This highly advanced machine - with new technology unique to Hoover - makes cleaning easier and more efficient.

You'll find it kinder to your carpets - and to you!

Please take the time to read this manual carefully.

You'll then be ready to make the most of the special features only the new Hoover Spirit can offer!

WARNING! ELECTRICITY CAN BE EXTREMELY DANGEROUS

This appliance is double-insulated and must not be earthed.

The plug is fitted with a 13 amp fuse.

IMPORTANT:The wires in the mains lead are coloured in accordance with the following code:

Blue - NEUTRAL
Brown - LIVE

In the unlikely event that any item is missing or you experience any problems with the product, **DO NOT TAKE IT BACK TO THE SHOP**

Please contact the Hoover customer helpline:
Tel: 08444 995 599
Email: customer.services@hoovercandy.com

Should any faults occur with your cleaner during the first 12 months, contact the Hoover Customer Helpline on the number above.

If you are having difficulty in obtaining filters or any other accessories for your cleaner contact the Hoover Customer helpline or order online at www.hooverspares.com

GETTING TO KNOW YOUR CLEANER

Effortless cleaning with your new Hoover SPIRIT

When first unpacking your cleaner please check all items are included:

Cleaner body
Main handle
Long Crevice Tool
2 in 1 tool (Furniture nozzle /
Dusting brush)
Rigid extension tube
Pet Hair & Allergen Remover*

If any parts are missing contact your retailer or call the Hoover helpline on 08444 995 599

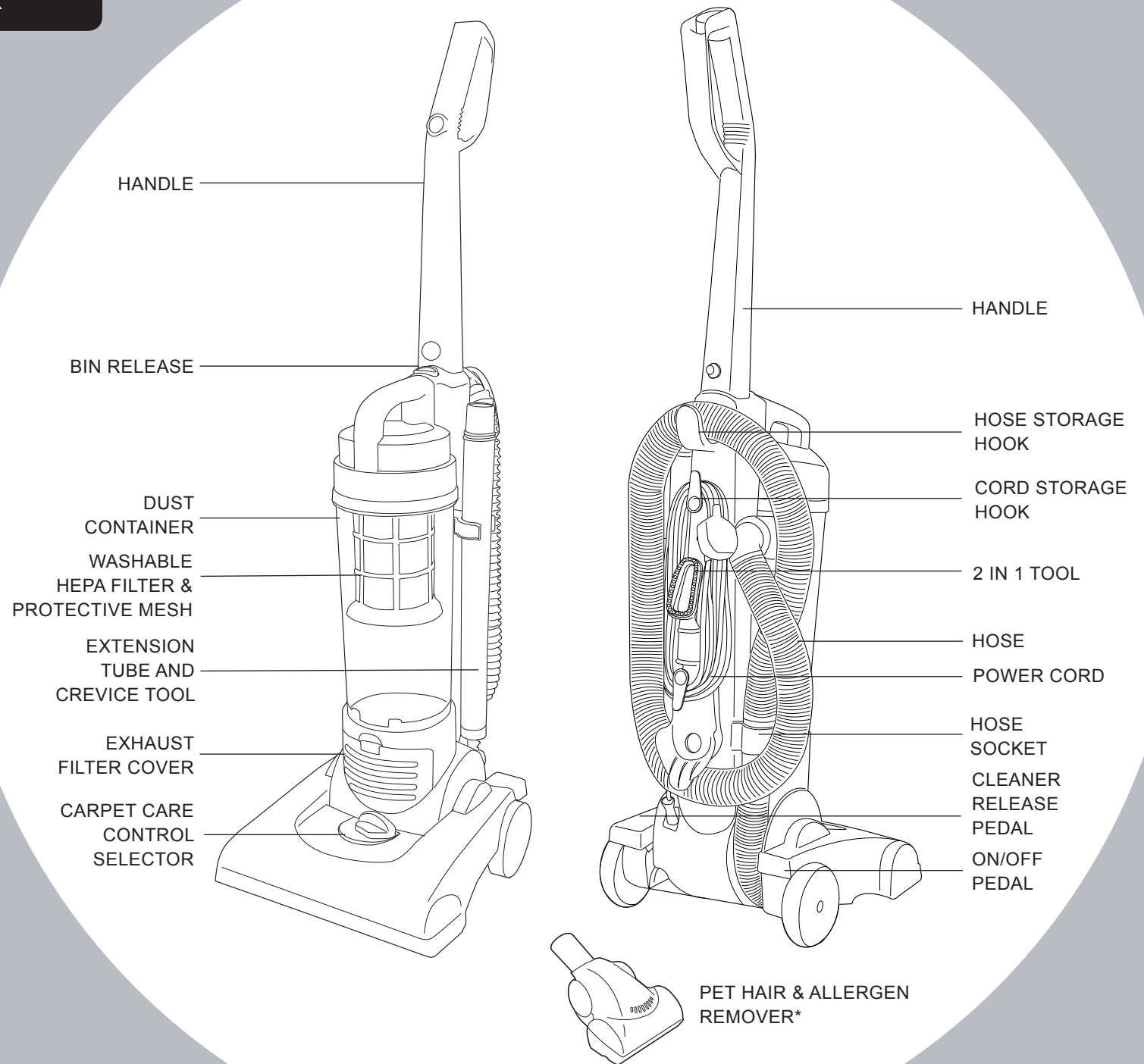

PREPARING YOUR CLEANER

Insert the main handle in the cleaner body and then fix it with the screw provided. To tighten the screw you can use a standard coin.

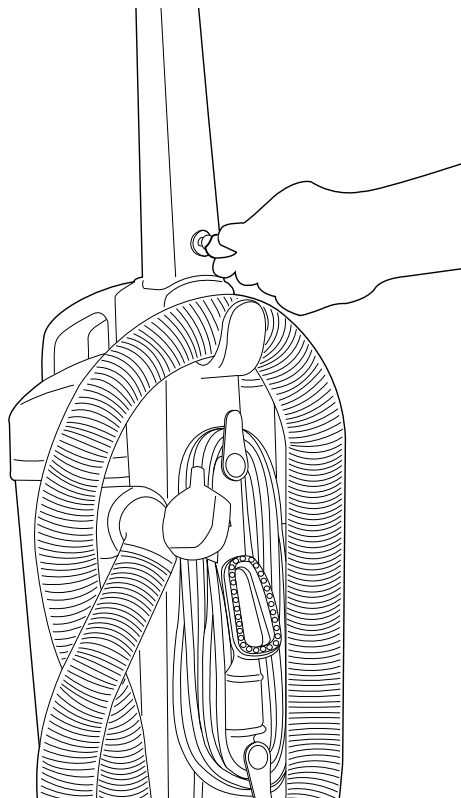

CARPET CARE CONTROL SELECTOR

The carpet care control selector raises and lowers the height of the foot.

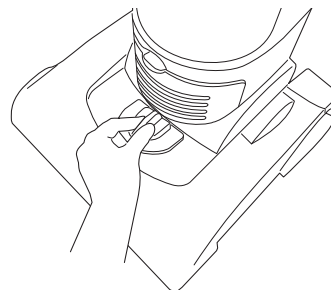

For a medium pile carpet, the best carpet cleaning is achieved by setting the selector to the INTENSIVE CLEAN position.

For all other types of carpet try various settings until you get the best result for your carpet.

Ensure that the cleaner is in an upright (parked) position.

Rotate knob to position best suited to depth of carpet pile.

Note: Using this cleaner for loop carpets or carpets with pile greater than 30mm is not recommended. Please consult the floorcare/carpet manufacturer's recommended cleaning instruction before vacuuming.

IMPORTANT! When cleaning hard floors such as vinyl or linoleum, move the selector knob to the HARD floor position. Failure to do so may cause damage to the floor surface.

CLEANER RELEASE

Unlock the cleaner by pressing down on the left pedal with your foot.



POWER SWITCH

To switch the cleaner on or off press down on the right pedal with your foot.

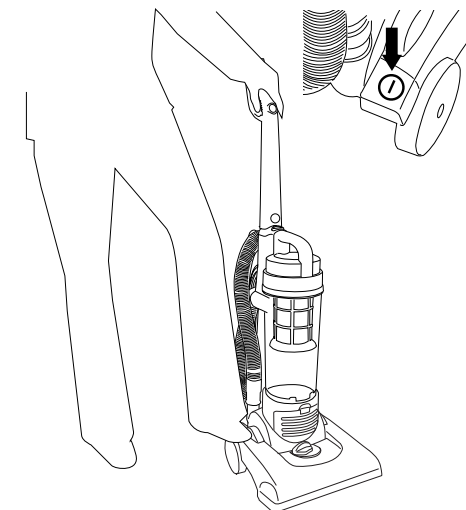

* Certain models only

CLEANING TOOLS

Handle

All accessories can fit onto the end of the hose. Combine accessories depending on use.

Pet Hair & Allergen Remover*

The pet hair & allergen remover is ideal for removing pet hairs.

DO NOT touch the rotating brush.

- 1 Remove hose from the hose socket.

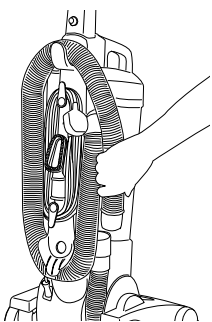

- 2 Pull out extension tube and crevice tool.

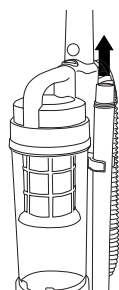

- 3 Remove the crevice tool from the extension tube.

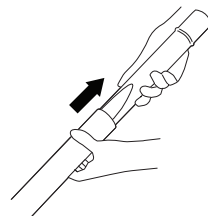

- 4 Fit the extension tube to the hose.

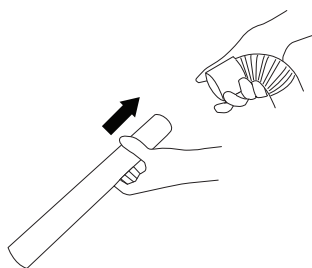

- 5 Attach the crevice tool to the extension tube or directly to the hose.

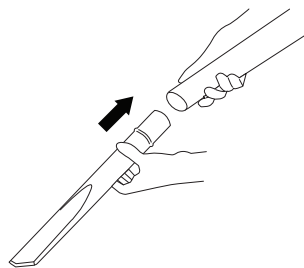

- 6 Fit the dusting brush or the Pet Hair and Allergen Remover* to the hose or at the end of the extension tube.

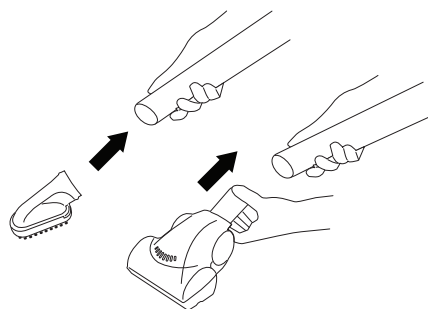

IMPORTANT! When using cleaning tools, the cleaner must be kept in the upright position, particularly when cleaning stairs. The nozzle height should also be set to tool mode.

* Certain models only

CLEANING THE STAIRS

It is dangerous to place the cleaner above you when cleaning stairs.

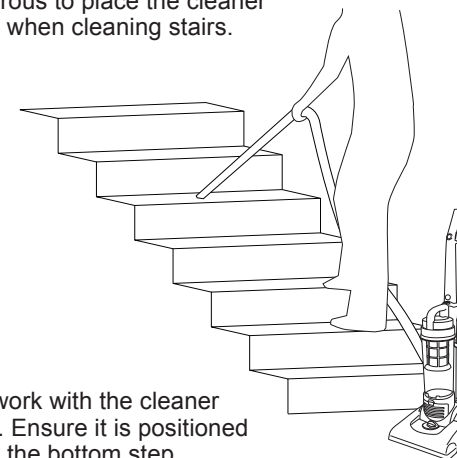

ALWAYS work with the cleaner below you. Ensure it is positioned up against the bottom step.

STORING THE CLEANER

Turn the cleaner off and remove the plug. Wind the power cord around the cord storage hooks.

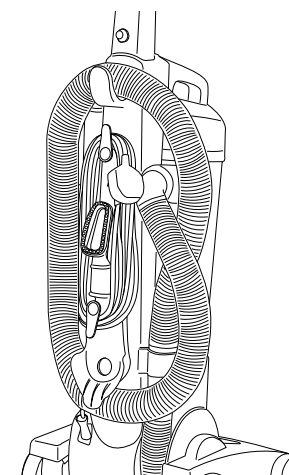

EMPTYING THE DUST CONTAINER

- 1 To remove the dust container from the cleaner press the bin release button.

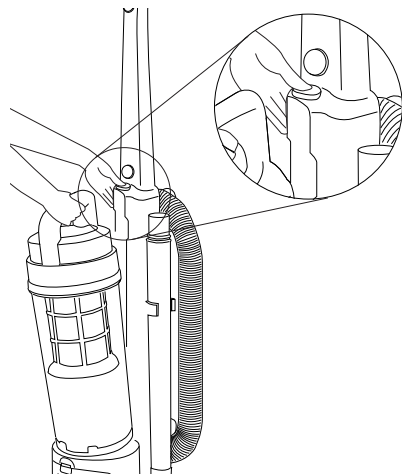

- 2 Hold the container over the Bin and press the easy open button at the rear of the container.

The dust container door will open and you can empty into a bin with no dust contact.

- 3 Once emptied, gently tap or shake the container to release any excess dust from the filters.

Do not overfill the bin above the max level line.

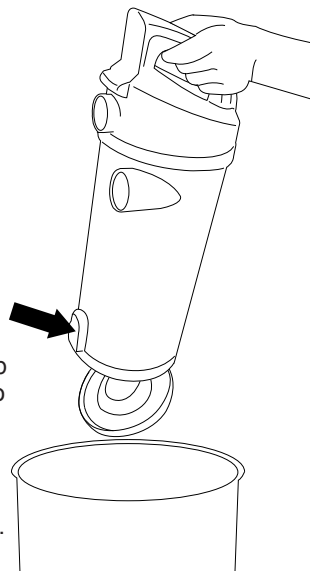

CLEANING THE PRE MOTOR FILTERS

- 1 Rotate the upper part of the dust bin to open.



- 2 Remove the filter assembly from the bin top by rotating the filter. It is advisable to wash the filters after every 5 bin empties.

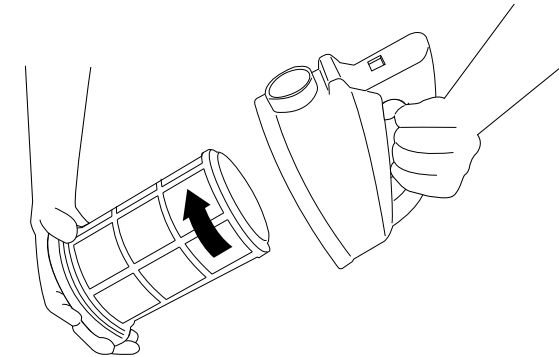

- 3 Remove the protective filter mesh from the HEPA filter, then gently tap both filters to release any excess dust.

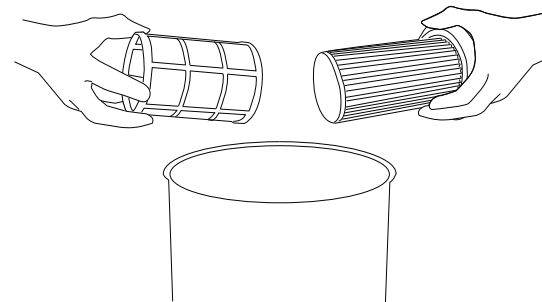

- 4 Wash both filter and protective mesh under warm water until the water runs clean. Remove excess water by shaking and leave to dry for 24 hours. Reassemble and refit filters to cleaner, only when they are completely dry.

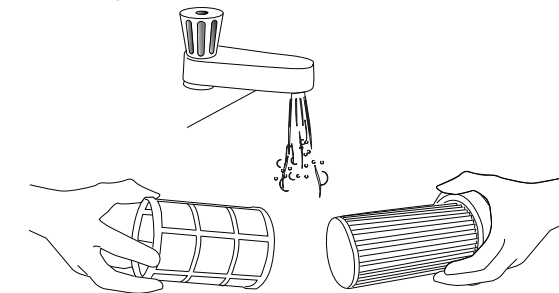

IMPORTANT! Ensure the protective mesh is reassembled to the HEPA filter before use

CLEANING THE EXHAUST FILTER

The exhaust filter should be washed every month. Press down on the latch to remove the exhaust cover. Remove filter and wash with warm water.

Remove excess water by shaking and leave to dry for 24 hours. Refit filters only when completely dry.

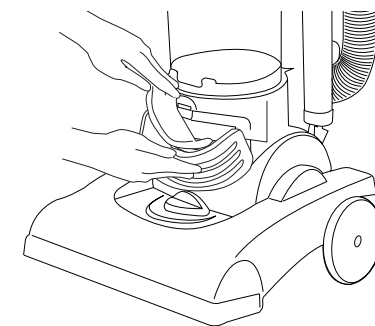

CHANGING THE BELT OR BRUSHES

If your cleaner is not picking up efficiently, the belt or brushes (or both) may need replacing, but first please make sure you have:

- Emptied the dust container
- Cleaned the filters
- Checked for blockages

! IMPORTANT: Switch the cleaner off and remove the plug from the electricity supply before dismantling cleaner

- 1** Turn the cleaner over and remove 6 retaining screws attaching the brush guard to the base.

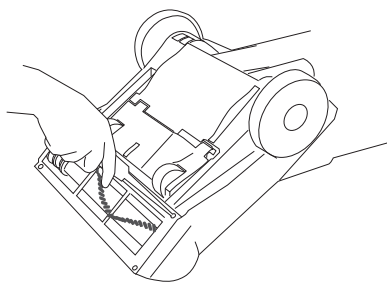

- 2** Remove the brush guard

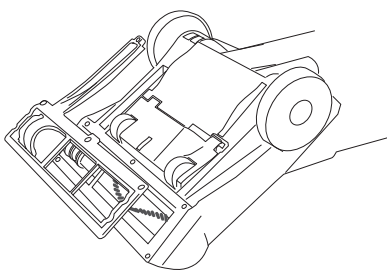

- 3** Remove brush assembly and check for wear on the belt.

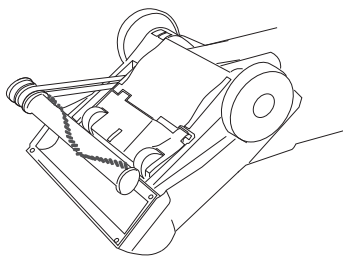

Loop the new belt around the motor and brush channel.

- 4** Hold the brush assembly and stretch the belt until the brush can be slotted back into the cleaner housing.

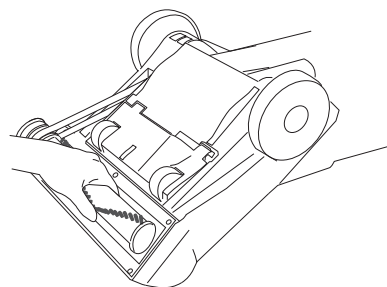

- 5** Rotate the brush to ensure free movement of the belt.

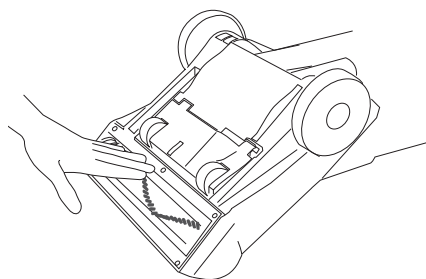

- 6** Refit the brush guard with 6 retaining screws.

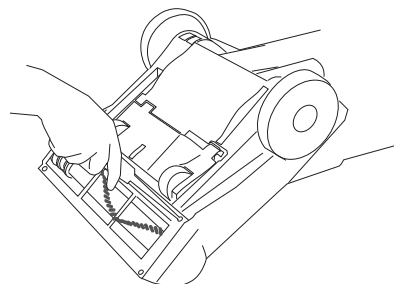

CLEARING A BLOCKAGE

! IMPORTANT: Switch the cleaner off and remove the plug from the electricity supply before dismantling cleaner

If cleaning tools were in use, check the cleaning tool and the hose.

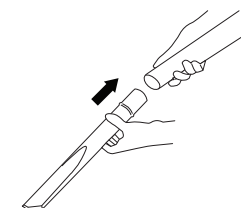

Check the hose by removing it from the cleaner.

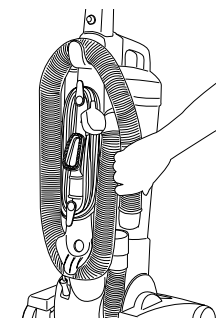

Turn the cleaner over and rotate the brushes until they are free to rotate.

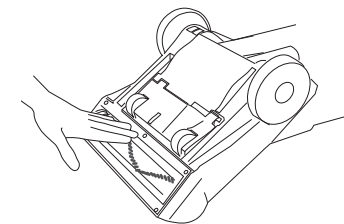

Check for a blockage in the hose socket. Use a flexible rod to remove any obstruction.

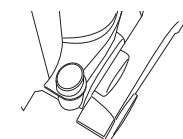

To remove a blockage from the Pet Hair & Allergen Remover*, open the nozzle at each side, lift cover and remove the blockage.

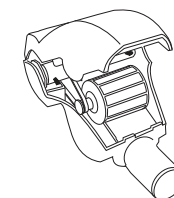

*Certain models only

Genuine HOOVER Spares

Tel. 08443 712 758
www.hooverspares.com

Always replace parts with genuine Hoover spares. When ordering parts, always quote your model number.

Hoover Customer Helpline

Should any faults occur with your cleaner during the first 12 months, contact the Hoover Customer Helpline on the number below.

Tel: 08444 995 599
Email: customer.services@hoovercandy.com

Hoover have a computerised nationwide service network of over 500 engineers who will quickly respond to your call and guarantee your repair for 12 months.

| CONSUMABLES | CODE |
|-----------------------------|-------------------|
| WASHABLE HEPA FILTER | S109 35601063 |
| EXHAUST MICROFILTER | T103 35601062 |
| AGITATOR | Y21 35600743 |
| BELT | V29 35600744 |
| | |
| SPARES | CODE |
| HOSE | D119 35601061 |
| 2 IN 1 TOOL | DUST B 35601065 |
| PET HAIR & ALLERGEN REMOVER | J44 35601064 |
| 2 PIECE EXTENSION TUBE | 2PIECE T 35601060 |

USE ONLY HOOVER SPARES

Quality

BSI ISO 9001

Hoover's factories have been independently assessed for quality. Our products are made using a quality system which meets the requirements of ISO 9001

Environment - WEEE Directive



This appliance is marked according to the European Directive 2002/96/EC on Waste Electrical and Electronic Equipment (WEEE).

By ensuring this product is disposed of correctly you will help prevent potential negative consequences for the environment and human health, which could otherwise be caused by inappropriate waste handling of this product.

The symbol on the product indicates that this product may not be treated as household waste. Instead it shall be handed over to the appliance collection point for recycling of electrical and electronic equipment.

Disposal must be carried out in accordance with the local environmental regulations for waste disposal.

For more detailed information about treatment, recovery and recycling of this product, please contact your local city office, your household waste disposal service or the shop where you purchased the product.

GUARANTEE STATEMENT

The guarantee conditions for this appliance are as defined by our representative in the country in which it is sold. Details regarding these conditions can be obtained from the dealer from whom the appliance was purchased. The bill of sale or receipt must be produced when making any claim under the terms of this guarantee.

User checklist

If your cleaner is not working properly run through the following checklist.

1. Is there a working electricity supply to the cleaner?
Check with another electrical product.
2. Is the dust container full or choked with fine dust?
To empty the dust container, see instructions on P6.
3. Is the hose blocked?
To clear a blockage, see instructions on P7.
4. Is there a blockage in the cleaner base?
To clear a blockage, see the instruction on P7.
5. Are the filters blocked?
To clean filters, see the instruction on P6.
6. Is the nozzle height set correctly?
To set the carpet height selector, see the instruction on p4.
7. Are the brushes rotating correctly?
To check the brushes, see the instructions on p7.
8. Has the cleaner overheated?
If so, it will take about 30 minutes to reset.

If there is any doubt, call the Hoover customer Helpline 08444 995 599 for advice. They may be able to assist you over the telephone.

WARNING

A thermal cut out switches off the cleaner to prevent overheating if it is used when full or there is a blockage or dirty filters. If this should happen switch off, unplug and correct the fault.

It will take approximately 30 minutes for the cut out to automatically reset.

IMPORTANT

**DO NOT RUN OVER THE POWER SUPPLY CORD
AS THIS COULD DAMAGE THE SUPPLY CORD
INSULATION.**



GENERATION FUTURE

Hoover Limited
Pentrebach
Merthyr Tydfil
Mid Glamorgan
CF48 4TU

HOOVER CUSTOMER HELPLINE
08444 995 599

© 2012 48005513

