

# Panasonic®

English

Model No.  
**TX-32AS600B**  
**TX-39AS600B**  
**TX-42AS600B**  
**TX-50AS600B**

## Operating Instructions LCD Television

32-inch model



39-inch model

42-inch model

50-inch model



# VIERA

For more detailed instructions, refer to [eHELP]  
(Built-in Operating Instructions).

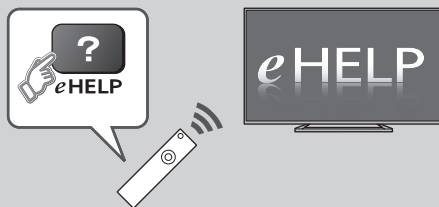

- How to use [eHELP] ➔ (p. 14)

Thank you for purchasing this Panasonic product.

Please read these instructions carefully before operating this product and retain them for future reference.

The images shown in this manual are for illustrative purposes only.



TQB0E2389U



- For the information of the trademarks, refer to [eHELP] (Support > Licence).

The illustration for TX-50AS600B is used in this manual unless otherwise mentioned. Illustrations shown may be different depending on the model.

## Contents

### Be Sure to Read

Important Notice	3
Safety Precautions	3

### Quick Start Guide

Accessories	6
Connections	8
Identifying Controls	11
First time Auto Setup	12

### Using your VIERA

Operations	13
How to Use eHELP	14

### Others

FAQs	15
Maintenance	16
Specifications	16

# Important Notice

## Notice for DVB / Data broadcasting / IPTV functions

This TV is designed to meet the standards (as of August, 2013) of digital services.

- Not all the features are available depending on the country, area, broadcaster, service provider and network environment.
- The compatibility with future services is not guaranteed.
- Check the latest information on the available services at the following website.

<http://panasonic.net/viera/support>

Panasonic does not guarantee operation and performance of peripheral devices made by other manufacturers; and we disclaim any liability or damage arising from operation and/or performance from usage of such other maker's peripheral devices.

This product is licensed under the AVC patent portfolio license for the personal and non-commercial use of a consumer to (i) encode video in compliance with the AVC Standard ("AVC Video") and/or (ii) decode AVC Video that was encoded by a consumer engaged in a personal and non-commercial activity and/or was obtained from a video provider licensed to provide AVC Video. No license is granted or shall be implied for any other use.

Additional information may be obtained from MPEG LA, LLC.

See <http://www.mpegla.com>.

Rovi Corporation and/or its subsidiaries and related affiliates are not in any way liable for the accuracy or availability of the program schedule information or other data in the Rovi Guide system and cannot guarantee service availability in your area. In no event shall Rovi Corporation and/or its related affiliates be liable for any damages in connection with the accuracy or availability of the program schedule information or other data in the Rovi Guide system.

Transport only in upright position

# Safety Precautions

To help avoid risk of electrical shock, fire, damage or injury, please follow the warnings and cautions below:

## ■ Mains plug and lead

### Warning

If you detect anything unusual, immediately switch off the mains supply switch and remove the mains plug.

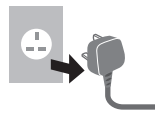

## IMPORTANT: THE MOULDED MAINS PLUG FOR YOUR SAFETY, PLEASE READ THE FOLLOWING TEXT CAREFULLY.

This TV is supplied with a moulded 3-pin mains plug for your safety and convenience.

A 5 amp fuse is fitted in this mains plug. Shall the fuse need to be replaced, please ensure that the replacement fuse has a 5 amp rating and that it is approved by ASTA or BSI to BS1362.

Check for the ASTA mark  or the BSI mark  on the fuse body.

If the mains plug contains a removable fuse cover, you must ensure that it is refitted when the fuse is replaced.

If you lose the fuse cover, the mains plug must not be used until a replacement cover is obtained.

A replacement fuse cover may be purchased from your local dealer.

Do not cut off the mains plug.

Do not use any other type of mains lead except the one supplied with this TV.

The supplied mains lead and moulded plug are designed to be used with this TV to avoid interference and for your safety.

If the socket outlet in your home is not suitable, get it changed by a qualified electrician.

If the plug or mains lead becomes damaged, purchase a replacement from an authorised dealer.

How to replace the fuse:

### For plug type shown in example 1

Lift out the removable fuse cover with a screwdriver and replace the fuse, then refit it securely into the mains plug.

### For plug type shown in example 2

Lift open the fuse cover in the mains plug with a screwdriver and replace the fuse, then press the fuse cover down securely.

Example 1



Example 2

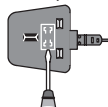

- This TV is designed to operate on AC 220-240 V, 50 / 60 Hz.

- Insert the mains plug fully into the socket outlet.
- Ensure that the mains plug is easily accessible.
- Disconnect the mains plug when cleaning the TV.
- Do not touch the mains plug with wet hands.



- Do not damage the mains lead.

- Do not place a heavy object on the lead.



- Do not place the lead near a high temperature object.



- Do not pull on the lead. Hold onto the mains plug body when disconnecting the plug.



- Do not move the TV with the lead plugged into a socket outlet.
- Do not twist the lead, bend it excessively or stretch it.
- Do not use a damaged mains plug or socket outlet.
- Ensure the TV does not crush the mains lead.

- Do not use any mains lead other than that provided with this TV.

## ■ Take care

### Warning

- Do not remove covers and never modify the TV yourself as live parts are accessible when they are removed. There are no user serviceable parts inside.
- Do not expose the TV to rain or excessive moisture. This TV must not be exposed to dripping or splashing water and objects filled with liquid, such as vases, must not be placed on top of or above the TV.
- Do not insert foreign objects into the TV through the air vents.
- Do not use an unapproved pedestal / mounting equipment. Be sure to ask your local Panasonic dealer to perform the setup or installation of approved wall-hanging brackets.
- Do not apply strong force or impact to the display panel.
- Do not place the TV on sloped or unstable surfaces, and ensure that the TV does not hang over the edge of the base.
- This TV is designed for table-top use.
- Do not expose the TV to direct sunlight and other sources of heat.



**To prevent the spread of fire, keep candles or other open flames away from this product at all times**



## ■ Dangerous part / Small object

### Warning

- This product contains possibly dangerous parts such as plastic bags, that can be breathed in or swallowed by young children accidentally. Keep these parts out of reach of young children.

## ■ Pedestal

### Warning

- Do not disassemble or modify the pedestal.

### Caution

- Do not use any pedestal other than the one provided with this TV.
- Do not use the pedestal if it becomes warped or physically damaged. If this occurs, contact your nearest Panasonic dealer immediately.
- During setup, make sure that all screws are securely tightened.
- Ensure that the TV does not suffer any impact during installation of the pedestal.
- Ensure that children do not climb onto the pedestal.
- Install or remove the TV from the pedestal with at least two people.
- Install or remove the TV by the specified procedure.

## ■ Radio wave

### Warning

- Do not use the TV in any medical institutions or locations with medical equipment. Radio waves may interfere with the medical equipment and cause accidents due to the malfunction.
- Do not use the TV near any automatic control equipment such as automatic doors or fire alarms. Radio waves may interfere with the automatic control equipment and cause accidents due to the malfunction.
- Keep the distance at least 22 cm from the TV when you have a cardiac pacemaker. Radio waves may interfere with the operation of the pacemaker.
- Do not disassemble or alter the TV in any way.

## ■ Built-in wireless LAN

### Caution

- Do not use the built-in wireless LAN to connect to any wireless network (SSID\*) for which you do not have usage rights. Such networks may be listed as a result of searches. However, using them may be regarded

as illegal access.

\*SSID is a name for identifying a particular wireless network for transmission.

- Do not subject the built-in wireless LAN to high temperatures, direct sunlight or moisture.
- Data transmitted and received over radio waves may be intercepted and monitored.
- The built-in wireless LAN uses 2.4 GHz and 5 GHz frequency bands. To avoid malfunctions or slow response caused by radio wave interference, keep the TV away from the devices such as other wireless LAN devices, microwaves, mobile phones and the devices that use 2.4 GHz and 5 GHz signals when using the built-in wireless LAN.
- When noises occur due to the static electricity, etc., the TV might stop operating for the protection of the devices. In this case, turn the TV off with Mains power On / Off switch, then turn it on again.
- Additional information for the wireless LAN and access point may be on the following website.  
<http://panasonic.net/viera/support>

## ■ Ventilation

### Caution

Allow sufficient space around the TV in order to help prevent excessive heat, which could lead to early failure of some electronic components.

Minimum distance:

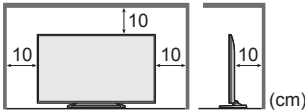

- Ventilation should not be impeded by covering the ventilation openings with items such as newspapers, tablecloths and curtains.
- Whether you are using a pedestal or not, always ensure the vents at the bottom of the TV are not blocked and there is sufficient space to enable adequate ventilation.



## ■ Moving the TV

### Caution

Before moving the TV, disconnect all cables.

39-inch model | 42-inch model | 50-inch model

- Move the TV with at least two people. Support as shown to avoid injury by the TV tipping or falling.



## ■ When not in use for a long time

### Caution

This TV will still consume some power even in the Off mode, as long as the mains plug is still connected to a live socket outlet.

- Remove the mains plug from the wall socket when the TV is not in use for a prolonged period of time.

## ■ Excessive volume

### Caution

- Do not expose your ears to excessive volume from the headphones. Irreversible damage can be caused.
- If you hear a drumming noise in your ears, turn down the volume or temporarily stop using the headphones.



## ■ Battery for the Remote Control

### Caution

- Incorrect installation may cause battery leakage, corrosion and explosion.
- Replace only with the same or equivalent type.
- Do not mix old and new batteries.
- Do not mix different battery types (such as alkaline and manganese batteries).
- Do not use rechargeable batteries (Ni-Cd, etc.).
- Do not burn or break up batteries.
- Do not expose batteries to excessive heat such as sunshine, fire or the like.
- Make sure you dispose of batteries correctly.
- Remove the battery from the unit when not using for a prolonged period of time to prevent battery leakage, corrosion and explosion.

## LCD Television



## Declaration of Conformity (DoC)

"Hereby, Panasonic Corporation declares that this TV is in compliance with the essential requirements and other relevant provisions of the Directive 1999/5/EC."

If you want to get a copy of the original DoC of this TV, please visit the following website:

<http://www.doc.panasonic.de>

Authorized Representative:

Panasonic Testing Centre  
Panasonic Marketing Europe GmbH  
Winsbergring 15, 22525 Hamburg, Germany

This TV is intended to be used in the following countries.  
Ireland, United Kingdom

The wireless LAN feature of this TV shall exclusively be used inside buildings.

# Accessories

## Remote Control

- ➔ (p. 11)
- N2QAYB000830



## Pedestal

- ➔ (p. 6)

32-inch model

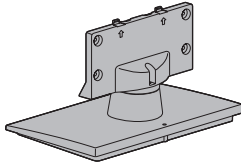

39-inch model    42-inch model  
50-inch model

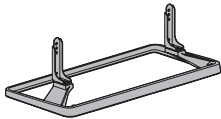

## Mains lead

- ➔ (p. 8)

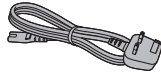

## Batteries (2)

- R6
- ➔ (p. 11)



## Operating Instructions

### Production Registration Leaflet

- Accessories may not be placed all together. Take care not to throw them away unintentionally.
- For the information of optional accessories, refer to [eHELP] (Support > Optional accessories).

## Assembling / Removing the pedestal

32-inch model

### A Assembly screw (3)



### B Assembly screw (4)



M4 × 15

### C Bracket

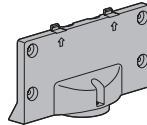

### D Base

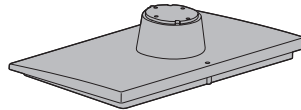

## ■ Assembling the pedestal

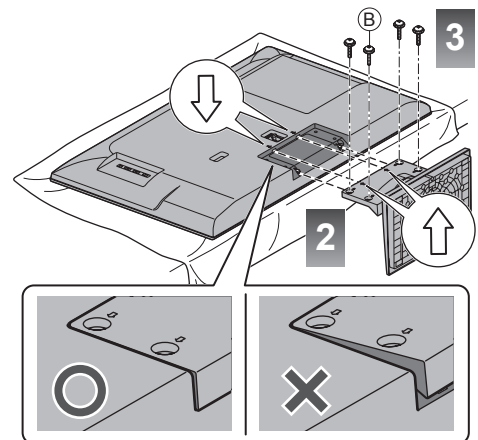
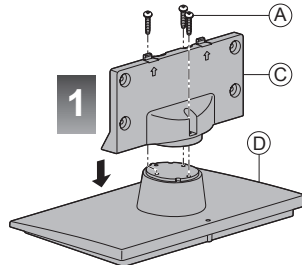

39-inch model 42-inch model 50-inch model

**(A) Assembly screw (4)**



**(B) Assembly screw (4)**



**(C) Bracket (2)**



**(D) Base**

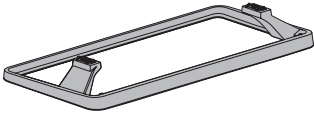

**■ Assembling the pedestal**

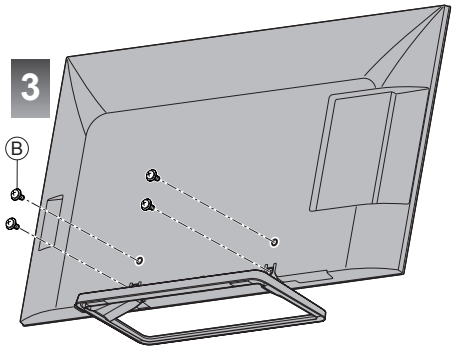
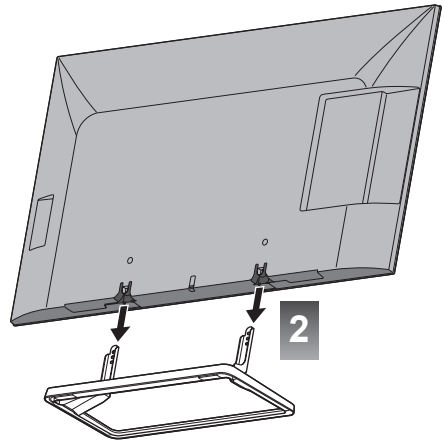
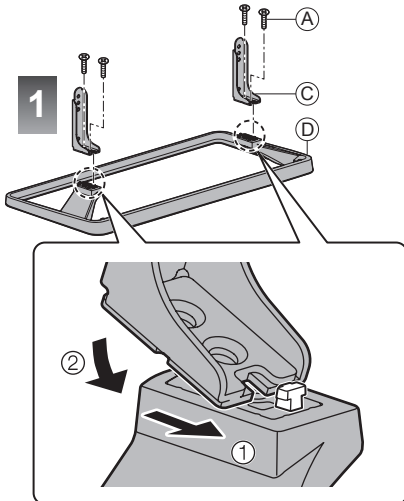

**Removing the pedestal from the TV**

Be sure to remove the pedestal in the following way when using the wall-hanging bracket or repacking the TV.

- 1 Remove the assembly screws (B) from the TV.
- 2 Pull out the pedestal from the TV.
- 3 Remove the assembly screws (A) from the bracket.

# Connections

- External equipment and cables shown are not supplied with this TV.
- Please ensure that the unit is disconnected from the mains socket before attaching or disconnecting any cables.
- Check the terminal type and cable plugs are correct when connecting.
- Use a fully wired HDMI compliant cable.
- Use a fully wired SCART cable.
- Keep the TV away from electronic equipment (video equipment, etc.) or equipment with an infrared sensor, otherwise distortion of image / sound may occur or operation of other equipment may be affected.
- Please also read the manual of the equipment being connected.

## Terminals

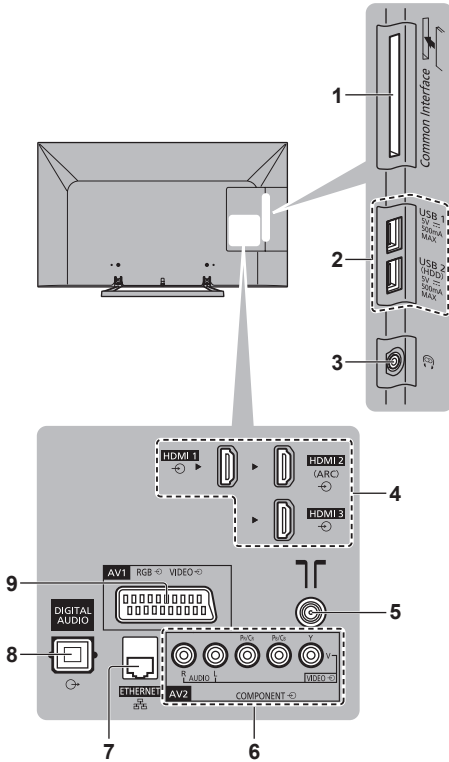

- 1 CI slot ➔ (p. 10)
- 2 USB 1 - 2 port
- 3 Headphone jack ➔ (p. 10)
- 4 HDMI1 - 3 ➔ (p. 9, 10)
- 5 Terrestrial terminal ➔ (p. 8)

- 6 AV2 (COMPONENT / VIDEO) ➔ (p. 9, 10)
- 7 ETHERNET ➔ (p. 9)
- 8 DIGITAL AUDIO
- 9 AV1 (SCART) ➔ (p. 9)

## Basic connections

### ■ Mains lead

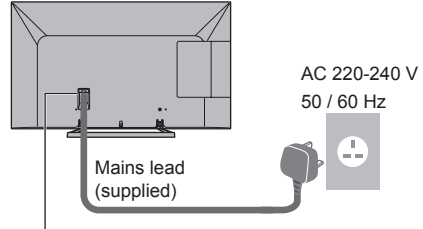

Insert the mains plug firmly into place.

32-inch model

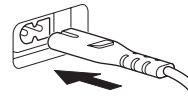

39-inch model

42-inch model

50-inch model

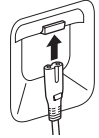

- When disconnecting the mains lead, be absolutely sure to disconnect the mains plug at the socket outlet first.

### ■ Aerial

TV

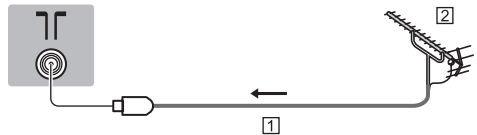

1 RF cable

2 Terrestrial aerial

- For DVB, Analogue



## AV devices

### ■ DVD Recorder / VCR

TV

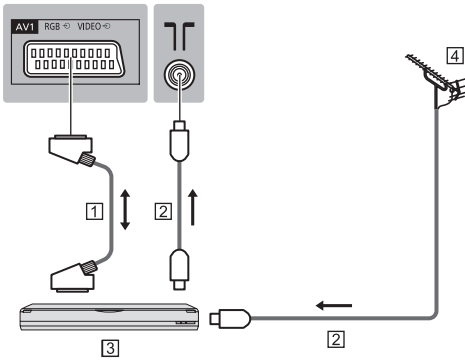

- 1 SCART cable
- 2 RF cable
- 3 DVD Recorder / VCR
- 4 Terrestrial aerial

### ■ DVD Recorder (VCR) / Satellite receiver

TV

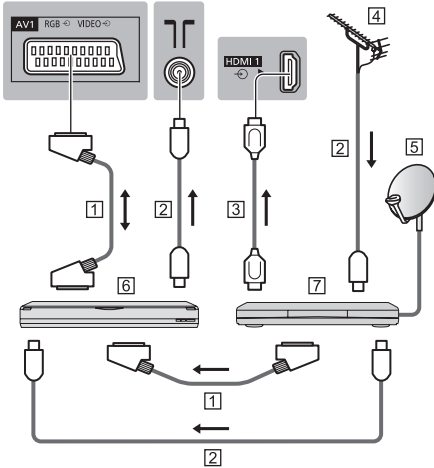

- 1 SCART cable
- 2 RF cable
- 3 HDMI cable
- 4 Terrestrial aerial
- 5 Satellite dish
- 6 DVD Recorder / VCR
- 7 Satellite receiver

## Network

To use internet service, you need a broadband network environment.

- If you do not have any broadband network services, please consult your retailer for assistance.
- Prepare the internet environment for wired connection or wireless connection.
- Setup of the network connection will start when first using the TV. ➔ (p. 12)

### ■ Wired connection

TV

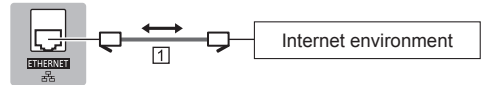

- 1 LAN cable (Shielded)
  - Use the Shielded Twist Pair (STP) LAN cable.

### ■ Wireless connection



- 1 Built-in wireless LAN
- 2 Access point

## Other connections

### ■ DVD Player

(COMPONENT equipment)

TV

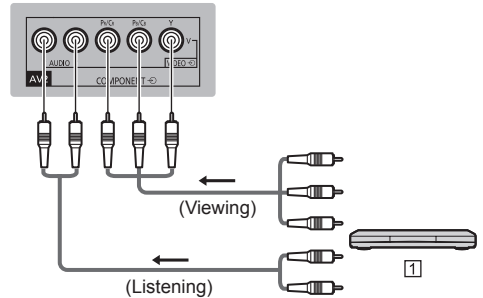

- 1 DVD Player

## ■ Camcorder / Game equipment

(VIDEO equipment)

TV

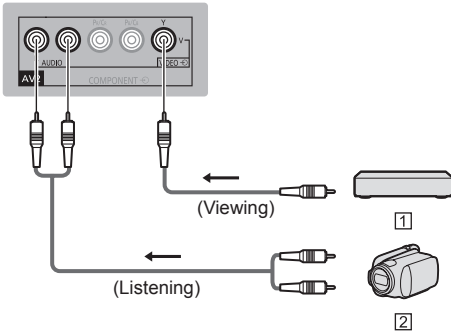

1 Game equipment

2 Camcorder

## ■ Amplifier (to listen with speakers)

- Use HDMI2 for connecting an amplifier. This connection is applicable when using an amplifier that has ARC (Audio Return Channel) function.

As for an amplifier without ARC function, use DIGITAL AUDIO.

- To enjoy multi-channel sound from external equipment (e.g. Dolby Digital 5.1ch), connect the equipment to the amplifier. For the connections, read the manuals of the equipment and amplifier.

TV

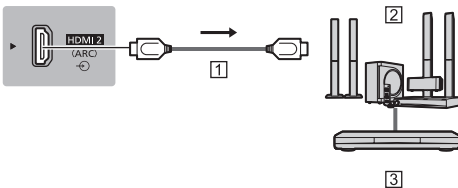

1 HDMI cable

2 Amplifier with speaker system

3 External equipment (DVD Player, etc.)

## ■ Headphones

- To adjust volume  
➔ **[Headphone Volume]** in the Sound Menu

TV



## ■ Common Interface

- Turn the TV off with Mains Power On / Off switch whenever inserting or removing the CI module.
- If a smart card and a CI module come as a set, first insert the CI module, then insert the smart card into the CI module.

- Insert or remove the CI module completely in the correct direction as shown.
- Normally encrypted channels will appear. (The viewable channels and its features depend on the CI module.)

If encrypted channels do not appear

### ➔ **[Common Interface]** in the Setup Menu

- There might be some CI modules in the market with older firmware versions that do not work fully interoperable with this new CI+ v1.3 TV. In this case, please contact your content provider.
- For more information, refer to **[eHELP]** (Functions > Common Interface), read the manual of the CI module, or check with the content provider.

TV

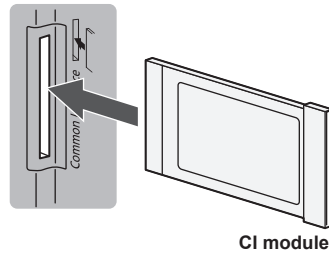

CI module

## ■ Communication Camera

- Use USB 1 for connecting the Communication Camera.
- For more information, refer to **[eHELP]** (Support > Optional accessories > Communication Camera).

## ■ VIERA Link

- Use HDMI1 - 3 for VIERA Link connection.
- For more information, refer to **[eHELP]** (Functions > VIERA Link "HDAVI Control™").

# Identifying Controls

## Remote Control

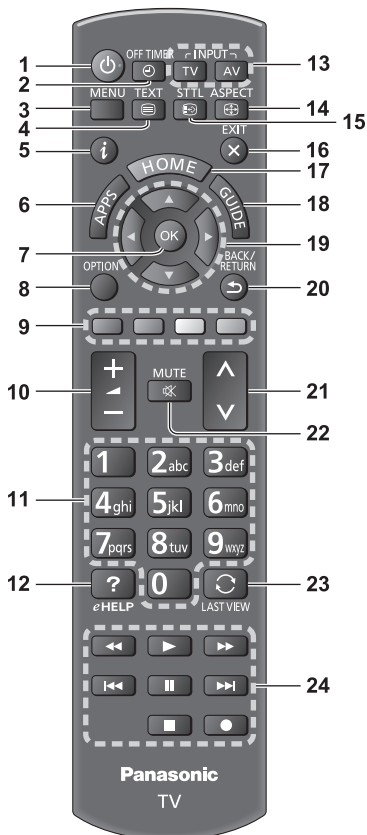

### 1 Standby On / Off switch

### 2 Off Timer

- Sets the time for the TV to automatically turn off.

### 3 [Main Menu]

- Press to access Picture, Sound, Network, Timer, Setup and Help Menus.

### 4 Text service button

### 5 Information

- Displays channel and programme information.

### 6 APPS

- Displays [APPS List] (applications list).

### 7 OK

- Confirms selections and choices.
- Press after selecting channel positions to quickly change channel.

### 8 [Option Menu]

- Easy optional setting for viewing, sound, etc.

### 9 Coloured buttons (red-green-yellow-blue)

- Used for the selection, navigation and operation of various functions.

### 10 Volume Up / Down

### 11 Numeric buttons

- Changes channel and teletext pages.
- Sets characters.
- When in Standby mode, switches TV on.

### 12 [eHELP]

- Displays [eHELP] (Built-in Operating Instructions).

### 13 Input mode selection

- TV - switches to DVB / Analogue mode.
- AV - switches to AV input mode from Input Selection list.

### 14 Aspect

- Changes aspect ratio.

### 15 Subtitles

- Displays subtitles.

### 16 Exit

- Returns to [Home Screen].

### 17 HOME

- Displays [Home Screen].

### 18 TV Guide

- Displays Electronic Programme Guide.

### 19 Cursor buttons

- Makes selections and adjustments.

### 20 Return

- Returns to the previous menu / page.

### 21 Channel Up / Down

### 22 Sound Mute On / Off

### 23 Last view

- Switches to previously viewed channel or input mode.

### 24 Operations for contents, connected equipment, etc.

## ■ Installing / Removing batteries

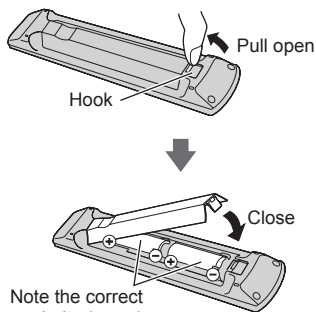

Note the correct polarity (+ or -)

## Indicator / Control panel

- When pressing 1, 2, 3 buttons, the control panel guide appears on the right side of the screen for 3 seconds to highlight the pressed button.

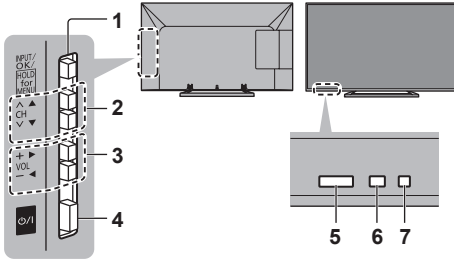

Rear side of the TV

### 1 Input mode selection

- Press repeatedly until you reach the desired mode.

#### [Main Menu]

- Press and hold for about 3 seconds to display main menu.

**OK** (when in the menu system)

### 2 Channel Up / Down

Cursor Up / Down (when in the menu system)

### 3 Volume Up / Down

Cursor Left / Right (when in the menu system)

### 4 Mains power On / Off switch

- Use to switch the mains power.

### 5 Remote control signal receiver

- Do not place any objects between the TV remote control signal receiver and remote control.

### 6 Ambient sensor

- Senses brightness to adjust picture quality when [Ambient Sensor] in the Picture Menu is set to [On].

### 7 Power LED

**Red:** Standby

**Green:** On

- The LED blinks when the TV receives a command from the remote control.

# First time Auto Setup

Automatically sets up the TV and searches for available TV channels when the TV is turned on for the first time.

- These steps are not necessary if the setup has been completed by your local dealer.
- Please complete connections (p. 8 - 10) and settings (if necessary) of the connected equipment before starting Auto Setup. For details of settings for the connected equipment, read the manual of the equipment.

## 1 Plug the TV into mains socket and turn power on



- Takes a few seconds to be displayed.



## 2 Select the following items

Set up each item by following the on-screen instructions.

Example:

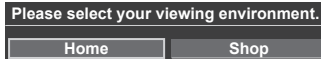

### ■ How to use remote control



Move the cursor



Access the item / store the setting



Return to the previous item (if available)

### Select [Home]

Select [Home] viewing environment to use in your home environment.

- [Shop] is for shop display.
- To change viewing environment later on, you will need to initialise all settings by accessing Shipping Condition.

### Set up the network connection

#### Select your country

Select your region UK only

## 3 Select the type of [Home Screen]

The demonstration to explain how to use [my Home

Screen] is displayed. Confirm the demonstration by following the on-screen instructions, and then select the desired [Home Screen].

Example: [Home Screen Selection]

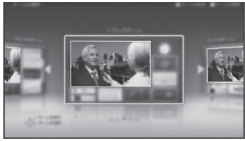

Example: [TV Home Screen]



**Auto Setup is now complete and your TV is ready for viewing.**

If tuning has failed, check the connection of the network, RF cable, and then follow the on-screen instructions.

**Note**

- The TV will automatically go into Standby mode when no operation is performed for 4 hours if [Auto Standby] in the Timer Menu is set to [On].
- The TV will automatically go into Standby mode when no signal is received and no operation is performed for 10 minutes if [No signal Power off] in the Timer Menu is set to [On].
- To retune all channels  
➔ **[Auto Setup] in [Tuning Menu] (Setup Menu)**
- To initialise all settings  
➔ **[Shipping Condition] in [System Menu] (Setup Menu)**

# Operations

## Turn power on

⏻ (TV)

or



(Remote Control)

- Mains power On / Off switch should be on. (p. 12)

The last viewed [Home Screen] is displayed.

Example: [TV Home Screen]

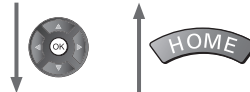

Example: Selected content screen



- To return to [Home Screen] at any time



- You can set up or make [Home Screen] to display desired information, to access specific features easily, to select the default [Home Screen], etc. For details, follow the on-screen instructions or refer to [eHELP] (my Home Screen > my Home Screen).

## Watching TV

### 1 Select the TV viewer from [Home Screen]



### 2 Select DVB or Analogue

TV

- The selectable modes vary depending on the channels stored.



- You can also select the mode pressing the TV button repeatedly.

### 3 Select a channel



- DVB channel position begins from number 1 upward. Analogue channel position numbers are in the 0 - 99 range.

### To access each feature

Access [APPS List] and select a feature



Example: [APPS List]



APPS is the applications (features) of the TV.

- For operations of each feature and the setup of [APPS List], follow the on-screen instructions or refer to [eHELP] (my Home Screen > APPS List).

# How to Use eHELP

[eHELP] is the detailed operating instructions built into the TV, and helps you to get more understanding of the operations for each feature.

## 1 Display [eHELP]



or



- If this is not the first time to view [eHELP] from when the TV is turned on, the confirmation screen is displayed to select whether [First Page] or [Last Page].

## 2 Select the category and item

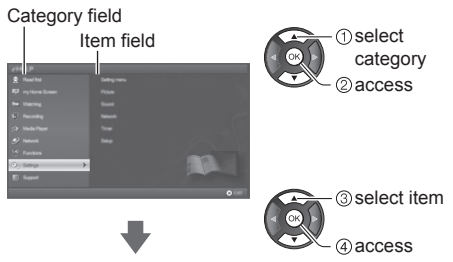

- To return to the previous field



- To scroll the description (if more than 1 page)  
While the description is highlighted



- To display the menu related to the description (only for some descriptions)



# FAQs

---

Before requesting service or assistance, please follow these simple guides to solve the problem.

- For more information, refer to [eHELP] (Support > FAQs).

---

## The TV does not switch on

- Check the mains lead is plugged into the TV and the socket outlet.
- The fuse in the mains plug may have blown. Replace it with one of an identical rating. ➔ (p. 3)

---

## The TV goes into Standby mode

- Auto power standby function is activated.

---

## The remote control does not work or is intermittent

- Are the batteries installed correctly? ➔ (p. 11)
- Has the TV been switched on?
- The batteries may be running low. Replace them with new ones.
- Point the remote control directly at the TV's remote control signal receiver (within about 7 m and a 30 degree angle of the signal receiver).
- Situate the TV away from sunshine or other sources of bright light not to shine on the TV's remote control signal receiver.

---

## No image can be displayed

- Check the TV is turned on.
- Check the mains lead is plugged into the TV and the socket outlet.
- Check the correct input mode is selected.
- Check the setting of [AV2] ([COMPONENT] / [VIDEO]) in [Input Selection] to match the output of the external equipment.
- Is [Contrast], [Brightness] or [Colour] in the Picture Menu set to the minimum?
- Check all required cables and connections are firmly in place.

---

## Unusual image is displayed

- Turn the TV off with Mains power On / Off switch, then turn it on again.
- If the problem persists, initialise all settings.  
➔ [Shipping Condition] in [System Menu] (Setup Menu)

---

## Parts of the TV become hot

- Even if the temperature of parts of the front, top and rear panels has risen, these temperature rises do not cause any problems in terms of performance or quality.

---

## The LCD panel moves slightly and clattered sound is

## heard when it is pushed with a finger

- There is a little gap around the panel to prevent damage to the panel. This is not a malfunction.

Check you can get Freeview HD in your area. Text your postcode, followed by your house number or name to **80560\***. Or visit **freeview.co.uk**

\*e.g. NW96NY1 (Costs no more than a normal text.)

To get the most up to date service from Freeview it is important for Freeview customers to retune from time to time.

## How do I re-tune my Freeview TV ?

This is a quick reference. If you have any problems, check the Operating Instructions or ask a friend or family member to show you how. Alternatively, go to your local electrical retailer, contact your local Panasonic dealer or visit **freeview.co.uk/retune**

Re-tuning only takes a few minutes, just follow the steps below:

1. Press the TV button to select DVB mode.
2. Press the MENU button to open the main menu.
3. [Setup] ➔ [DVB-T Tuning Menu] ➔ [Auto Setup]

Please note: most digital TV recorders will keep your original recordings after running a re-tune but you will need to reset any future recordings.

# Maintenance

First, remove the mains plug from the socket outlet.

## Display panel, Cabinet, Pedestal

### Regular care:

Gently wipe the surface of the display panel, cabinet, or pedestal by using a soft cloth to clean the dirt or fingerprints.

### For stubborn dirt:

- (1) First clean the dust on the surface.
- (2) Dampen a soft cloth with clean water or diluted neutral detergent (1 part detergent to 100 parts water).
- (3) Wring the cloth firmly. (Please note liquids do not enter the TV inside. May lead to product failure.)
- (4) Finally, wipe away all the moisture.

### Caution

- Do not use a hard cloth or rub the surface too hard, otherwise this may cause scratches on the surface.
- Take care not to subject the surfaces to insect repellent, solvent, thinner or other volatile substances. This may degrade surface quality or cause peeling of the paint.
- The surface of the display panel is specially treated and may be easily damaged. Take care not to tap or scratch the surface with your fingernail or other hard objects.
- Do not allow the cabinet and pedestal to make contact with a rubber or PVC substance for a long time. This may degrade surface quality.

## Mains plug

Wipe the mains plug with a dry cloth at regular intervals. Moisture and dust may cause fire or electrical shock.

# Specifications

## ■ TV

### Model No.

32-inch model : TX-32AS600B

39-inch model : TX-39AS600B

42-inch model : TX-42AS600B

50-inch model : TX-50AS600B

### Dimensions (W × H × D)

32-inch model

733 mm × 505 mm × 184 mm (With Pedestal)

733 mm × 436 mm × 59 mm (TV only)

39-inch model

886 mm × 560 mm × 247 mm (With Pedestal)

886 mm × 516 mm × 53 mm (TV only)

42-inch model

947 mm × 597 mm × 247 mm (With Pedestal)

947 mm × 552 mm × 53 mm (TV only)

50-inch model

1 126 mm × 697 mm × 260 mm (With Pedestal)

1 126 mm × 652 mm × 53 mm (TV only)

### Mass

32-inch model

7.0 kg Net (With Pedestal)

6.5 kg Net (TV only)

39-inch model

11.0 kg Net (With Pedestal)

10.0 kg Net (TV only)

42-inch model

13.0 kg Net (With Pedestal)

12.0 kg Net (TV only)

50-inch model

16.0 kg Net (With Pedestal)

15.0 kg Net (TV only)

### Power source

AC 220-240 V, 50 / 60 Hz

### Panel

LED LCD panel

### Sound

#### Speaker output

20 W (10 W + 10 W)

#### Headphones

M3 (3.5 mm) stereo mini Jack × 1



## Connection terminals

### AV1 input / output

**SCART** (Audio/Video in, Audio/Video out, RGB in)

### AV2 input (COMPONENT / VIDEO)

#### VIDEO

RCA PIN Type × 1

1.0 V[p-p] (75 Ω)

#### AUDIO L - R

RCA PIN Type × 2

0.5 V[rms]

#### Y

1.0 V[p-p] (including synchronisation)

#### Pb, Pr

±0.35 V[p-p]

### HDMI 1 / 2 / 3 input

TYPE A Connectors

HDMI1 / 3: Content Type

HDMI2: Content Type, Audio Return Channel

- This TV supports "HDAVI Control 5" function.

### Card slot

Common Interface slot (complies with CI Plus) × 1

### ETHERNET

RJ45, IEEE802.3 10BASE-T / 100BASE-TX

### USB 1 / 2

DC 5 V, Max. 500 mA [Hi-Speed USB (USB 2.0)]

### DIGITAL AUDIO output

PCM / Dolby Digital / DTS, Fibre optic

## Receiving systems / Band name

Check the latest information on the available services at the following website.

<http://panasonic.net/viera/support>

### DVB-T / T2

Digital terrestrial services

**UK**

#### PAL I

UHF E21 - 68

**Ireland**

#### PAL I

VHF A - J

CATV S1 - S20

UHF E21 - E69

CATV S21 - S41 (Hyperband)

### PAL 525/60

Playback of NTSC tape from some PAL Video recorders (VCR) or NTSC disc playback from DVD player and recorder

### M.NTSC

Playback from M.NTSC Video recorders (VCR)

### NTSC (AV input only)

Playback from NTSC Video recorders (VCR)

## Aerial input

**UK**

UHF

**Ireland**

VHF / UHF

## Operating conditions

### Temperature

0 °C - 35 °C

### Humidity

20 % - 80 % RH (non-condensing)

## Built-in wireless LAN

### Standard compliance and Frequency range\*

IEEE802.11a/n

5.180 GHz - 5.320 GHz, 5.500 GHz - 5.580 GHz,

5.660 GHz - 5.700 GHz

IEEE802.11b/g/n

2.412 GHz - 2.472 GHz

### Security

WPA2-PSK (TKIP/AES)

WPA-PSK (TKIP/AES)

WEP (64 bit/128 bit)

\*: The frequency and channel differ depending on the country.

### Note

- Design and Specifications are subject to change without notice. Mass and Dimensions shown are approximate.
- For the information of power consumption, display resolution, etc., please refer to Product fiche.
- For the information of the open source software, refer to [eHELP] (Support > Licence).
- This equipment complies with the EMC standards listed below.  
EN55013, EN61000-3-2, EN61000-3-3, EN55020, EN55022, EN55024

### ■ When using the wall-hanging bracket

- Please contact your local Panasonic dealer to purchase the recommended wall-hanging bracket.
- Holes for wall-hanging bracket installation

32-inch model

Rear of the TV

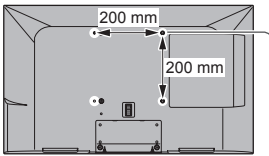

(View from the side)

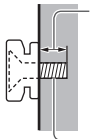

**Depth of screw**

**minimum: 7 mm**

**maximum: 12 mm**

**Diameter: M4**

Screw for fixing the TV onto the wall-hanging bracket (not supplied with the TV)

39-inch model

42-inch model

50-inch model

Rear of the TV

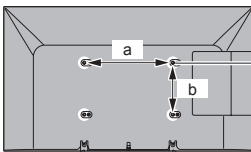

39-inch model

42-inch model

a: 200 mm

b: 200 mm

50-inch model

a: 400 mm

b: 200 mm

(View from the side)

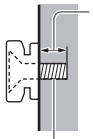

**Depth of screw**

39-inch model

42-inch model

**minimum: 10 mm**

**maximum: 27 mm**

50-inch model

**minimum: 10 mm**

**maximum: 28 mm**

**Diameter: M6**

Screw for fixing the TV onto the wall-hanging bracket (not supplied with the TV)



## Information for Users on Collection and Disposal of Old Equipment and used Batteries



These symbols on the products, packaging, and/or accompanying documents mean that used electrical and electronic products and batteries should not be mixed with general household waste. For proper treatment, recovery and recycling of old products and used batteries, please take them to applicable collection points, in accordance with your national legislation and the Directives 2002/96/EC and 2006/66/EC.

By disposing of these products and batteries correctly, you will help to save valuable resources and prevent any potential negative effects on human health and the environment which could otherwise arise from inappropriate waste handling.



For more information about collection and recycling of old products and batteries, please contact your local municipality, your waste disposal service or the point of sale where you purchased the items.

Penalties may be applicable for incorrect disposal of this waste, in accordance with national legislation.

### For business users in the European Union

If you wish to discard electrical and electronic equipment, please contact your dealer or supplier for further information.

### [Information on Disposal in other Countries outside the European Union]

These symbols are only valid in the European Union. If you wish to discard these items, please contact your local authorities or dealer and ask for the correct method of disposal.

### Note for the battery symbol (bottom two symbol examples):

This symbol might be used in combination with a chemical symbol. In this case it complies with the requirement set by the Directive for the chemical involved.



Cd

## Sales and Support Information

### Customer Communications Centre

- For customers within the UK: **0844 844 3899**
- For customers within Ireland: **01289 8333**
- Monday – Friday 9:00am – 5:00pm, (Excluding public holidays).
- For further support on your product, please visit our website: [www.panasonic.co.uk](http://www.panasonic.co.uk)

### Direct Sales at Panasonic UK

- Order accessory and consumable items for your product with ease and confidence by phoning our Customer Communications Centre Monday – Friday 9:00am – 5:00pm, (Excluding public holidays).
- Or go on line through our Internet Accessory ordering application at [www.pas-europe.com](http://www.pas-europe.com).
- Most major credit and debit cards accepted.
- All enquiries transactions and distribution facilities are provided directly by Panasonic UK.
- It couldn't be simpler!
- Also available through our Internet is direct shopping for a wide range of finished products. Take a browse on our website for further details.

## Customer's Record

The model number and serial number of this product may be found on its rear panel. You should note this serial number in the space provided below and retain this book, plus your purchase receipt, as a permanent record of your purchase to aid in identification in the event of theft or loss, and for Warranty Service purposes.

**Model Number**

**Serial Number**

Panasonic UK, a branch of Panasonic Marketing Europe GmbH  
Willoughby Road, Bracknell, Berkshire, RG12 8FP  
Web Site: <http://panasonic.net>

English