

Camden - 2 Door Tall Robe

Assembly Instructions - Please keep for future reference

244/3012

227/6117

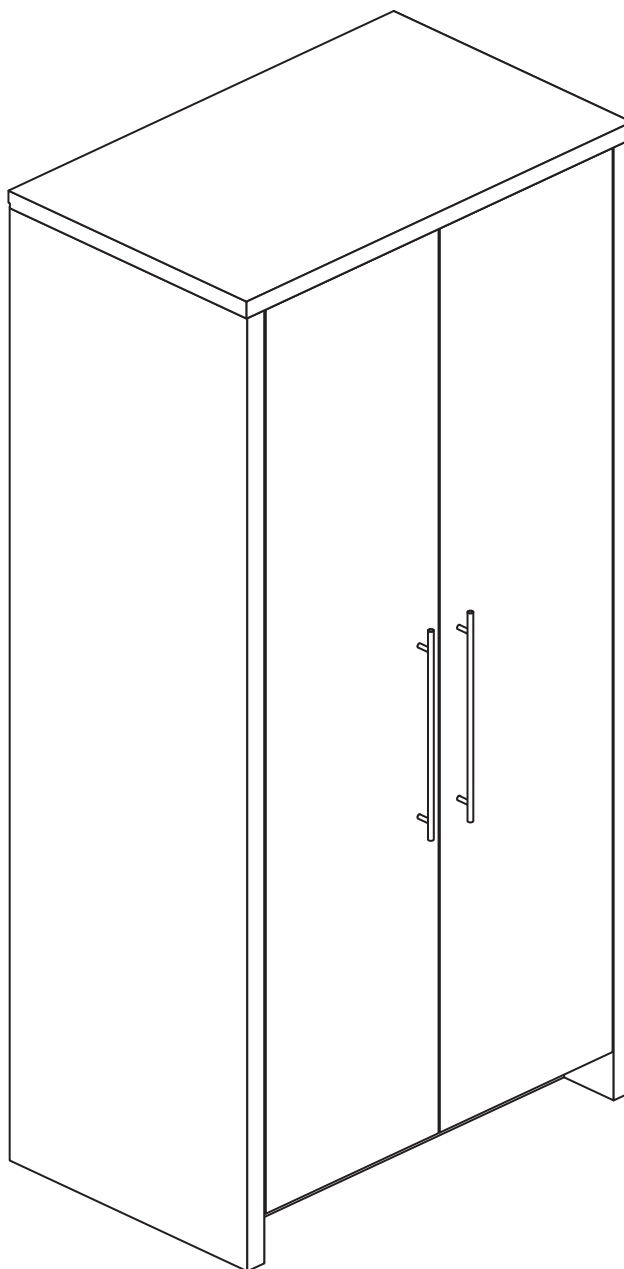

Dimensions

Width - 80cm

Depth - 49.5cm

Height - 200.5cm



**MADE IN
BRITAIN**

Important - Please read these instructions fully before starting assembly

If you need help or have damaged or missing parts, call the **Customer Helpline: 08456 400800**



Safety and Care Advice

Important - Please read these instructions fully before starting assembly

- **Warning:** This unit weighs approximately 47kgs. Please lift with care.

- Check you have all the components and tools listed on pages 2 and 3.

- Remove all fittings from the plastic bags and separate them into their groups.

- Keep children and animals away from the work area, small parts could choke if swallowed.

- Parts of the assembly will be easier with 2 people.

- Make sure you have enough space to layout the parts before starting.

- Do not stand or put weight on the product, this could cause damage.

- Assemble the item as close to its final position (in the same room) as possible.

- Assemble on a soft level surface to avoid damaging the unit or your floor (use opened out unit carton).



- We do not recommend the use of power drill/drivers **for inserting screws**, as this could damage the unit. Only use hand screwdrivers.

- **Safety note:** It is recommended that this unit is secured to a wall using the bracket supplied.

- Dispose of all packaging carefully and responsibly.

Care and maintenance

- Only clean using a damp cloth and mild detergent, do not use bleach or abrasive cleaners.

- From time to time check that there are no loose screws on this unit.

- This product should not be discarded with household waste. Take to your local authority waste disposal centre.

Note: If required the next page can be cut out and used as reference throughout the assembly. Keep this page with these instructions for future reference.

Components - Panels

If you have damaged or missing components, call the **Customer Helpline: 08456 400800** quoting the reference numbers below

Please check you have all the panels listed below

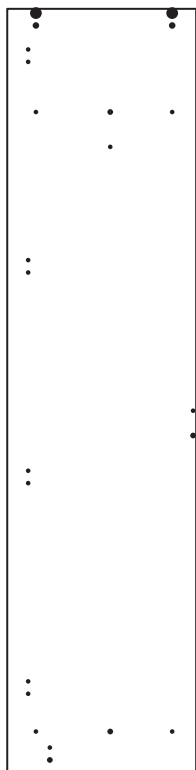

1 Left Side (DF1A1)
(1970 x 491mm)

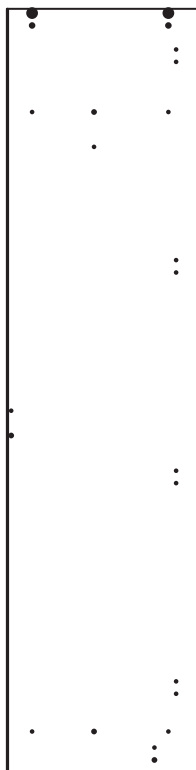

2 Right Side (DF2A1)
(1970 x 491mm)

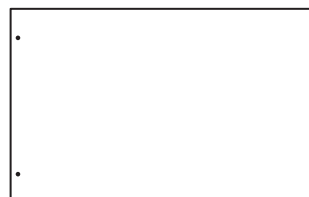

3 Top (DF3A1)
(796 x 492mm)



4 Horizontal (DF4A1)
(722 x 473mm) x 2



5 Plinth (DF5A1)
(722 x 96mm)

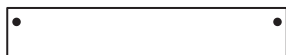

6 Back Rail (DF6A1)
(722 x 130mm)



7 Hanging Rail (FHR715)
(715mm long)

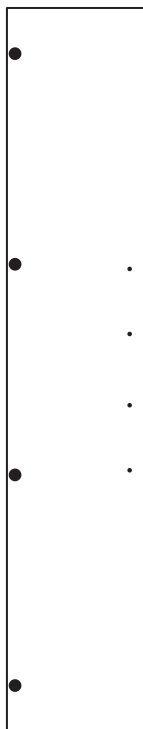

8 Door (DF7A1)
(1868 x 357mm) x 2

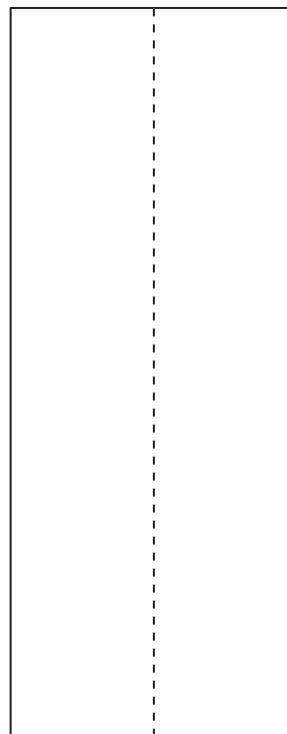

9 Back (X1882-740)
(1882 x 740mm)









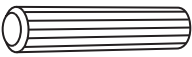
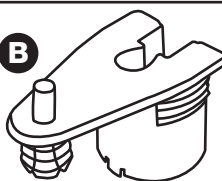

Components - Fittings

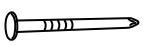



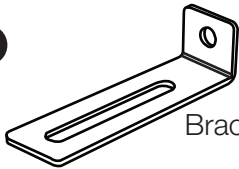
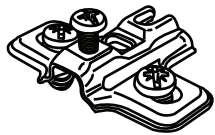
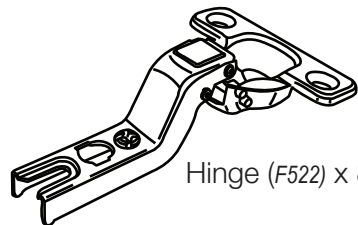
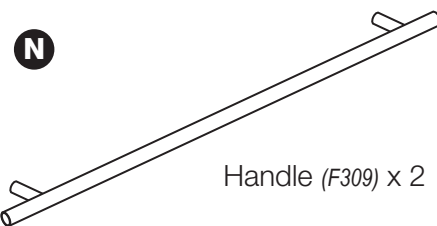

If you have damaged or missing components, call the **Customer Helpline: 08456 400800** quoting the reference numbers below

Please check you have all the fittings listed below

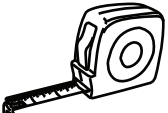
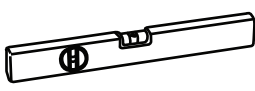
Note: The quantities below are the correct amount to complete the assembly. In some cases more fittings may be supplied than are required.

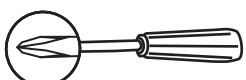
<p>A </p> <p>Wooden dowel (F22) x 8</p>	<p>B </p> <p>Hollow core locking nut (F892) x 4</p>	<p>C </p> <p>Small metal dowel (F893) x 4</p>
<p>D </p> <p>Nail (F51) x 35</p>	<p>E </p> <p>Rail Holder (F891) x 2</p>	<p>F </p> <p>13mm Screw (F63) x 20</p>
<p>G </p> <p>Metal dowel (F901) x 12</p>	<p>H </p> <p>Large locking nut (F900) x 12</p>	<p>I </p> <p>19mm Screw (F461) x 4</p>
<p>J </p> <p>13mm Screw (F79) x 1</p>	<p>K </p> <p>Bracket (F327) x 1</p>	<p>L </p> <p>Hinge plate (F523) x 8</p>
<p>M </p> <p>Hinge (F522) x 8</p>	<p>N </p> <p>Handle (F309) x 2</p>	

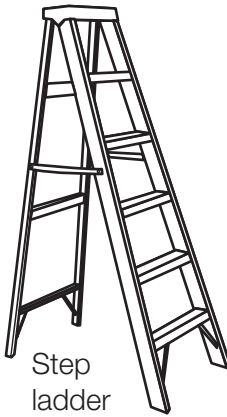
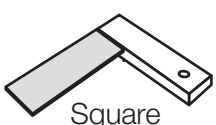
Tools required

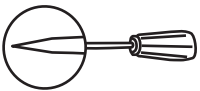
<p></p> <p>Rule</p>	<p></p> <p>Spirit level</p>	<p></p> <p>Eye protection (when using a hammer or drill)</p>	<p></p> <p>Cross-head screwdriver</p>	<p></p>	<p></p> <p>Step ladder</p>
<p></p> <p>Square</p>	<p></p> <p>Scissors</p>	<p></p> <p>Hammer</p>	<p></p> <p>Bradawl</p>	<p>Electric drill (only use when drilling into walls)</p>	

Ruler - Use this ruler to help correctly identify the screws

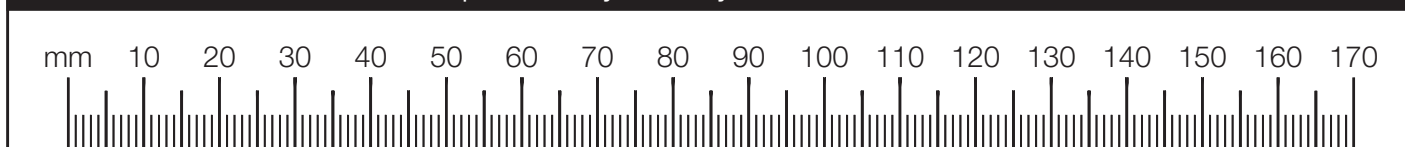

Assembly Instructions

If you have damaged or missing components, call the
Customer Helpline: 08456 400800 quoting the reference
numbers below

Step 1

Prepare the left side

a: To fit the rail holder **E**, screw through the top hole with screw **F** and into the shallow mark hole drilled in the left side **1**. Make sure that it is fitted straight, in line with the panel edges and then fit another screw **F** using the lower hole.

Screw 6 metal dowels **G** into the holes on the left side **1**.

Note: Tighten metal dowels up fully against the panel.

b: Fit 4 hinge plates **L** onto the left side **1**, making sure that the slot is facing towards the finished front edge.

Push 2 hollow core locking nuts **B** into the left side **1**, making sure that they are flush against the panel's surface.

Using a hammer, tap in the pin on the hollow core locking nut **B**.

Note: The pin should be tapped in flush with the top surface of the hollow core locking nut **B**.

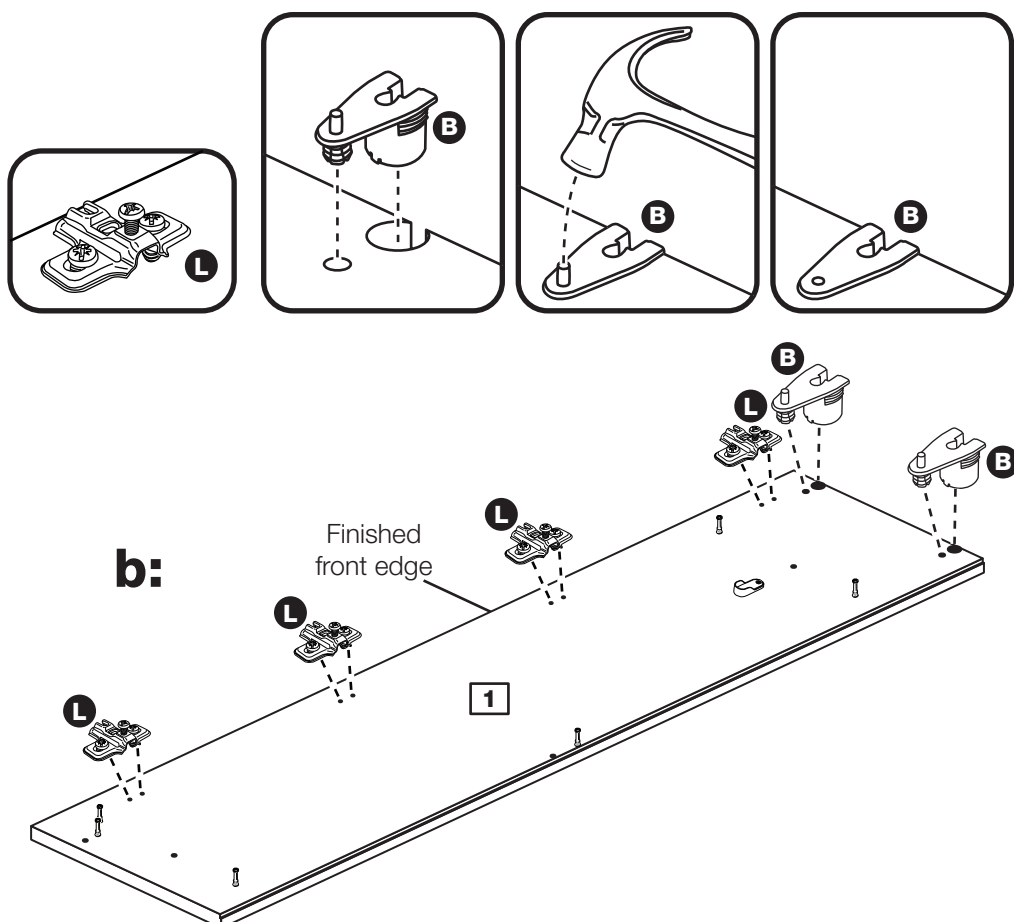
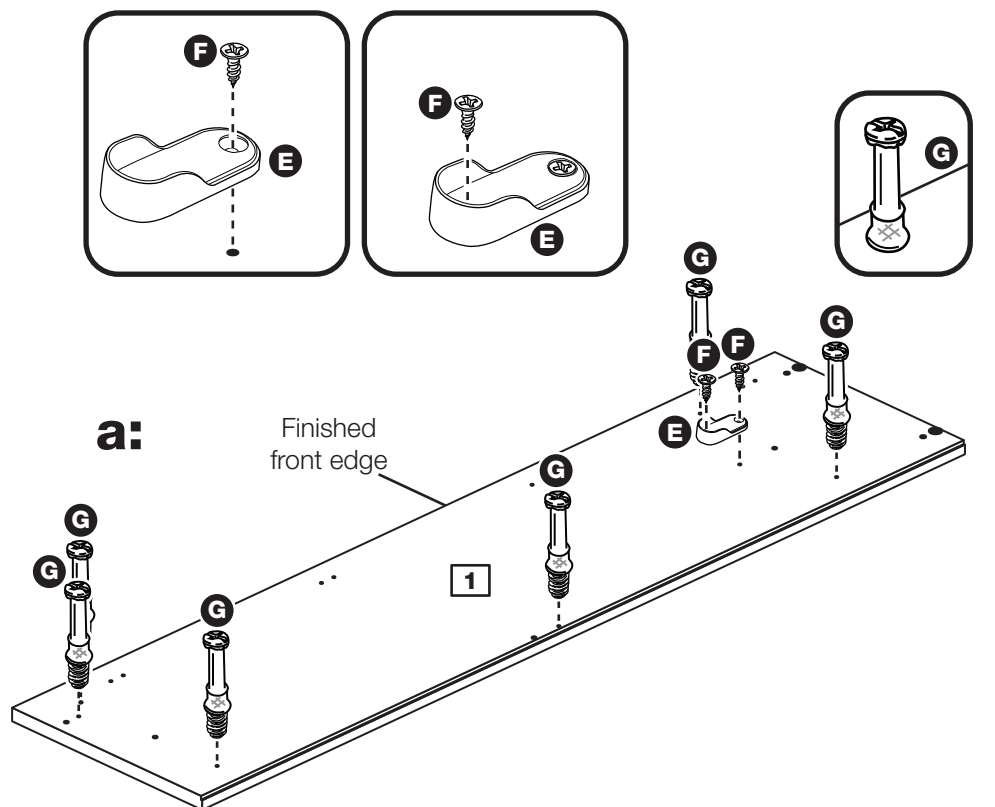

Assembly Instructions

Step 2

Prepare the right side

a: To fit the rail holder **E**, screw through the top hole with screw **F** and into the shallow mark hole drilled in the right side **2**. Make sure that it is fitted straight, in line with the panel edges and then fit another screw **F** using the lower hole.

Screw 6 metal dowels **G** into the holes on the right side **2**.

b: Fit 4 hinge plates **L** onto the right side **2**, making sure that the slot is facing towards the finished front edge.

Push 2 hollow core locking nuts **B** into the right side **2**, making sure that they are flush against the panel's surface.

Using a hammer, tap in the pin on the hollow core locking nut **B**.

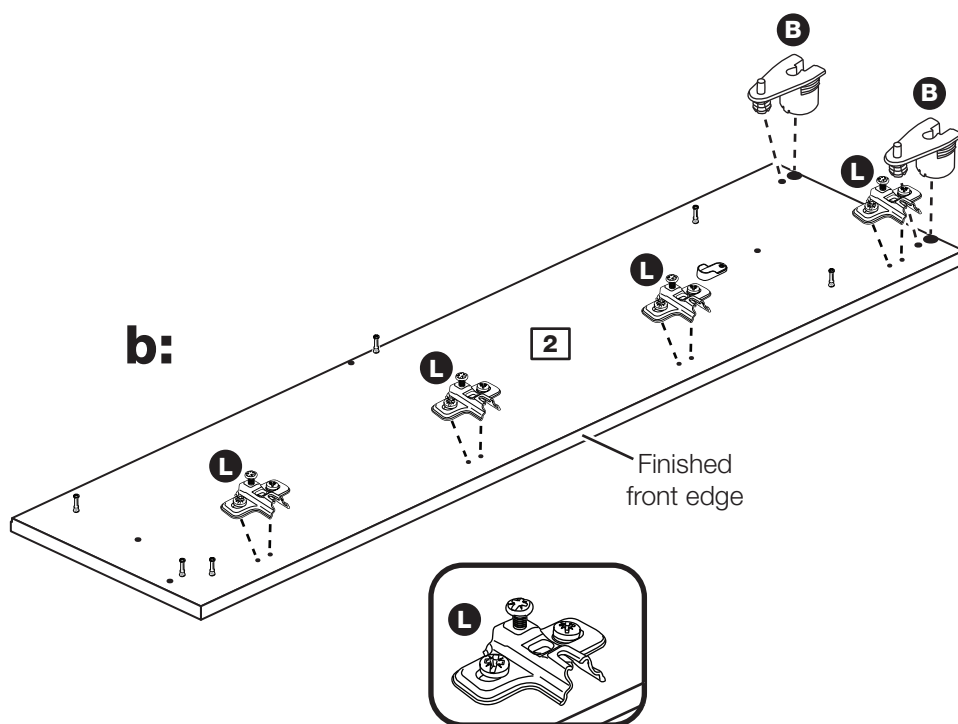
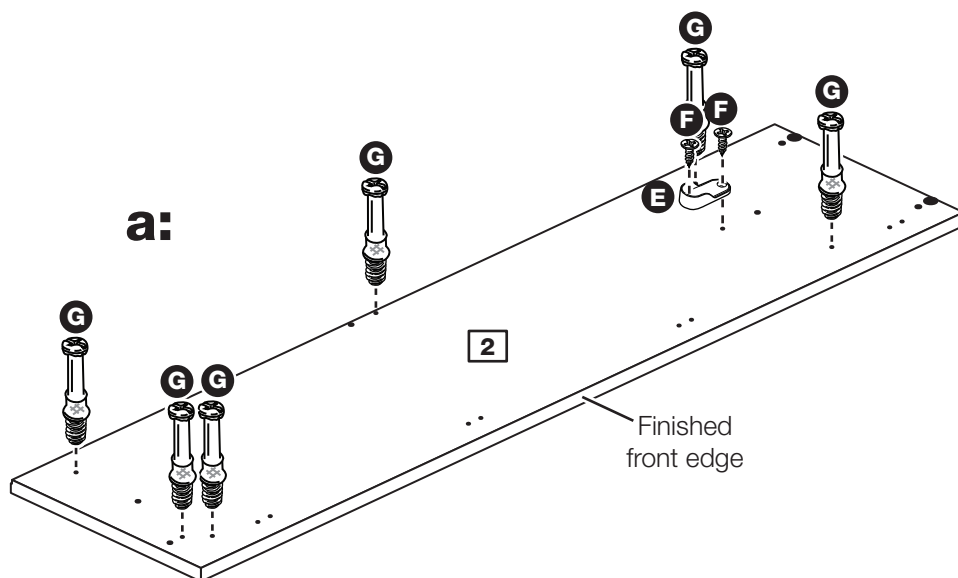

Assembly Instructions

Step 3

Prepare the 2 horizontals

Insert 4 large locking nuts **H** into each of the 2 horizontals **4**.

Note: The arrow on the locking nut **must** point towards the hole in the edge of the panel.

Tap 2 wooden dowels **A** into each of the 2 horizontals **4**.

Note: Wooden dowels **must not** stick out from the edge by more than 10mm or they may damage other panels.

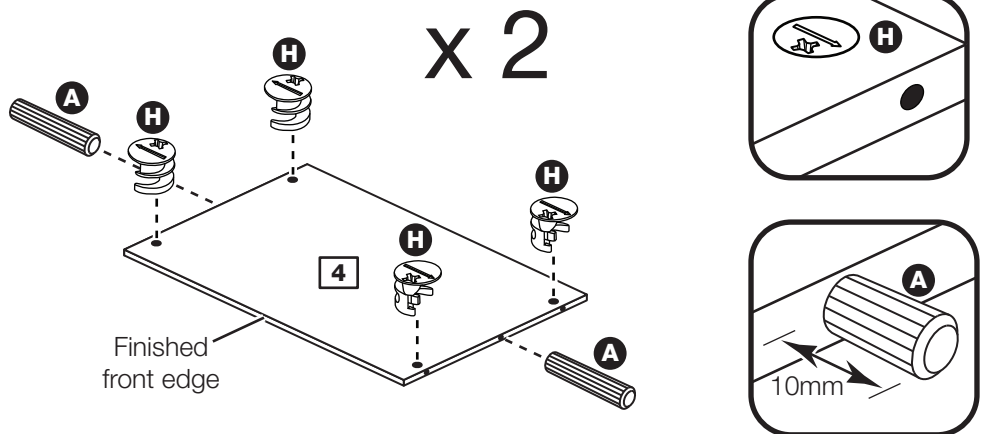

Step 4

Fit the 2 horizontals to the right side

Push the 2 horizontals **4** onto the right side **2**.

Use a screwdriver to tighten the 2 large locking nuts **H** fitted each horizontal **4**.

Note: Turn the large locking nuts **H** as far as they will go - more than 1/2 a turn.

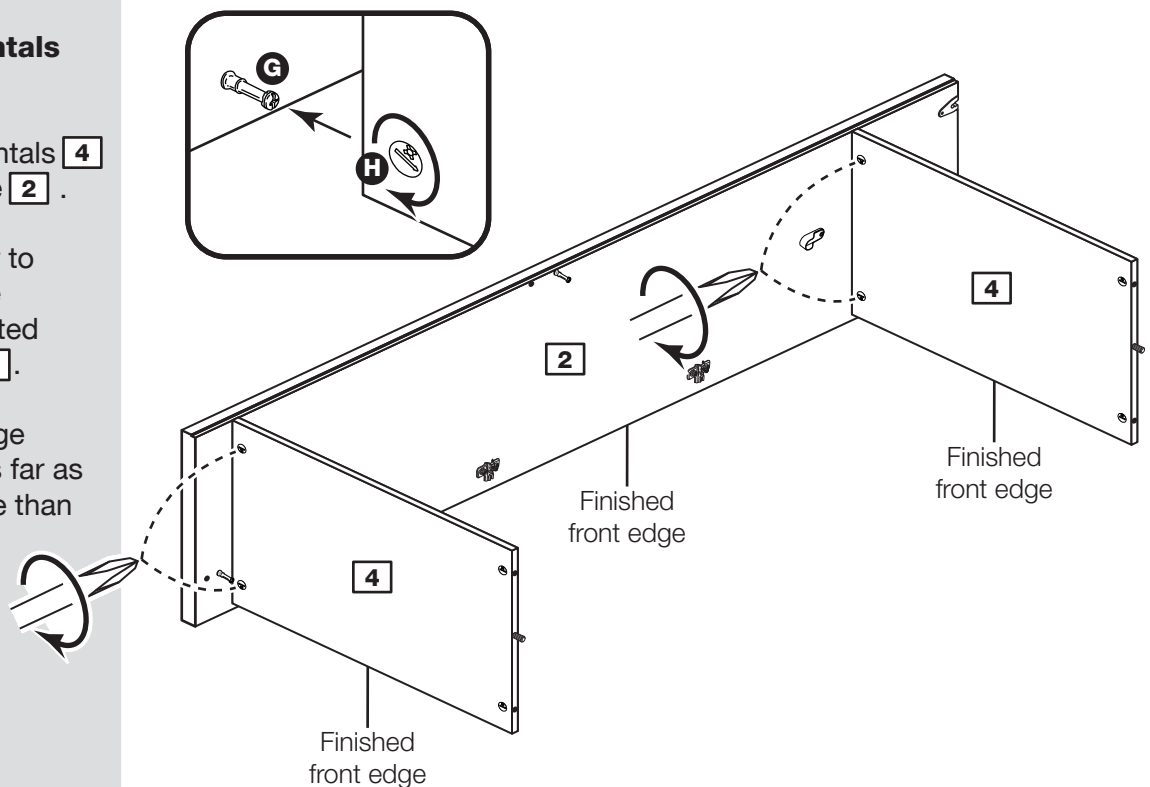

Assembly Instructions

Step 5

Prepare the top

Screw 4 small metal dowels **C** into the holes on the top **3**.

Note: Tighten metal dowels up fully against the panel.

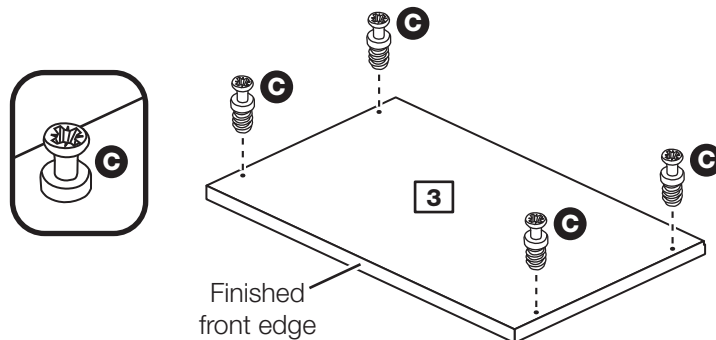

Step 6

Fit the top

Attach the top **3** onto the assembly.

Note: You will need to slide the 2 small metal dowels **C** into the top of the 2 hollow core locking nuts **B**.

Insert a screwdriver into the 2 hollow core locking nuts **B** and turn the nuts inside as far as they will go.

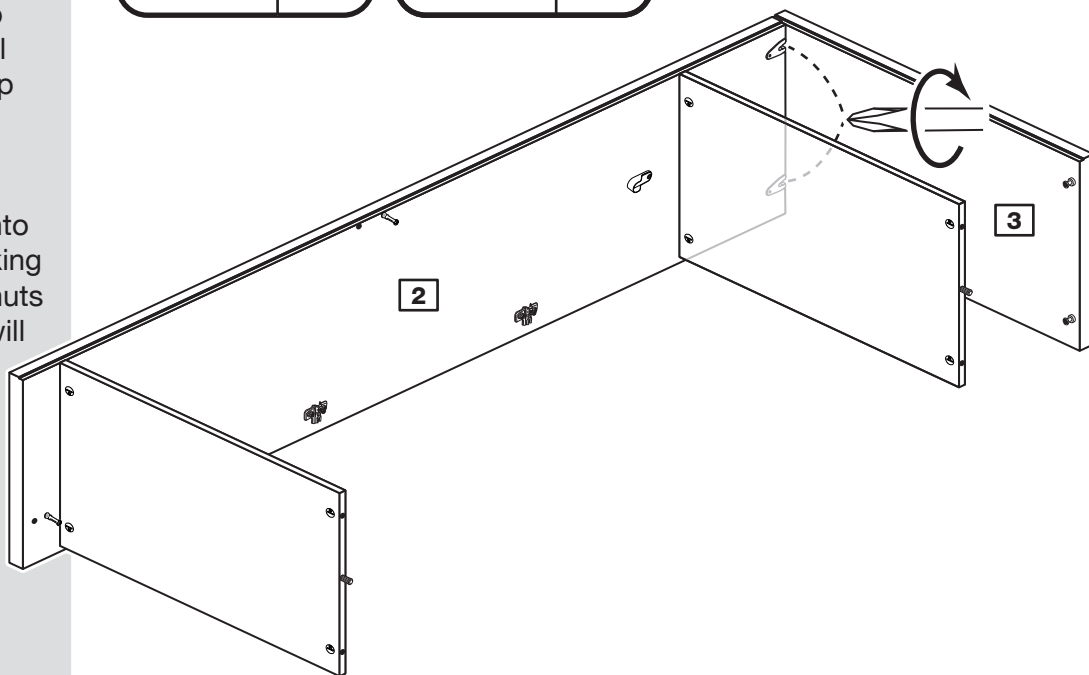
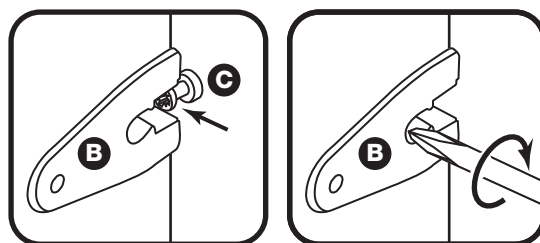

Step 7

Prepare the plinth and the back rail

Insert 2 large locking nuts **H** into the plinth **5** and 2 into the back rail **6**.

Tap 2 wooden dowels **A** into the plinth **5** and 2 into the back rail **6**.

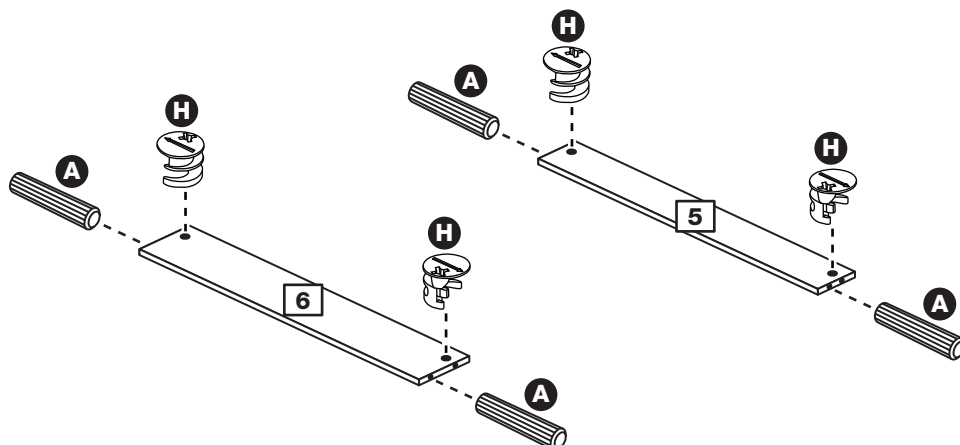

Assembly Instructions

Step 8

Fit the plinth and the back rail

Push the plinth **5** and the back rail **6** onto the right side **2**.

Use a screwdriver to tighten the 2 large locking nuts **H** fitted to the plinth **5** and back rail **6**.

Note: Support the end of the plinth **5** and back rail **6** until the left side has been fitted.

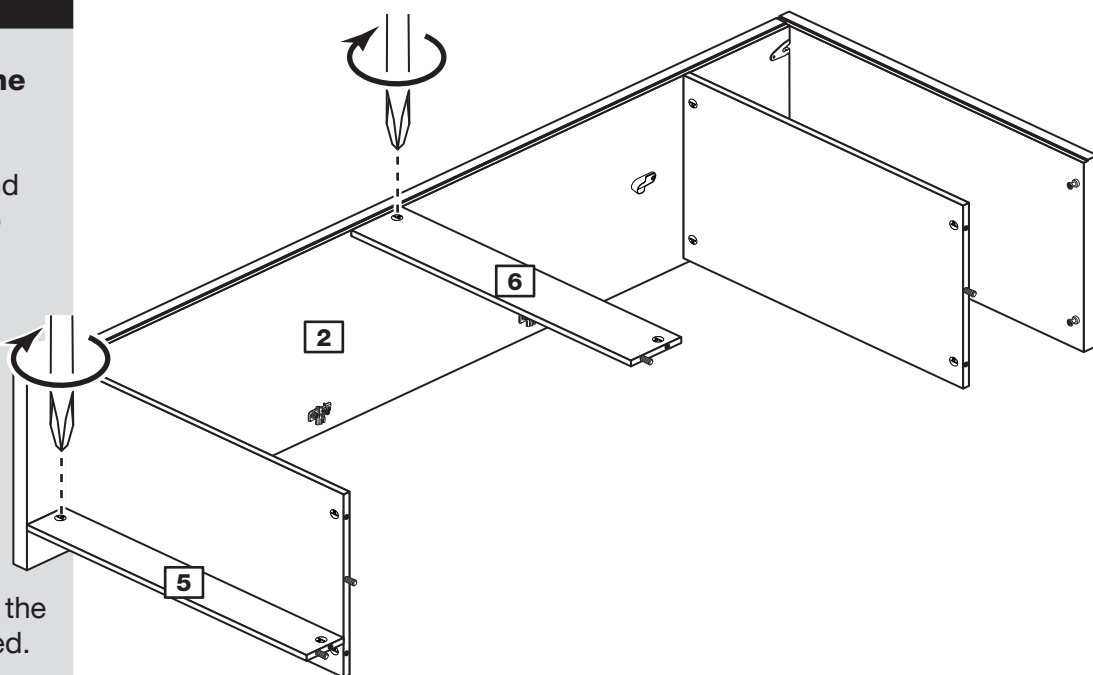

Step 9

Fit the left side

Push the left side **1** onto the assembly.

Note: You will need to slide the 2 small metal dowels **C** into the top of the 2 hollow core locking nuts **B**.

Insert a screwdriver into the 2 hollow core locking nuts **B** and turn the nuts inside as far as they will go.

Use a screwdriver to tighten the 6 large locking nuts **H** fitted to the horizontals **5**, plinth **6** and back rail **9**.

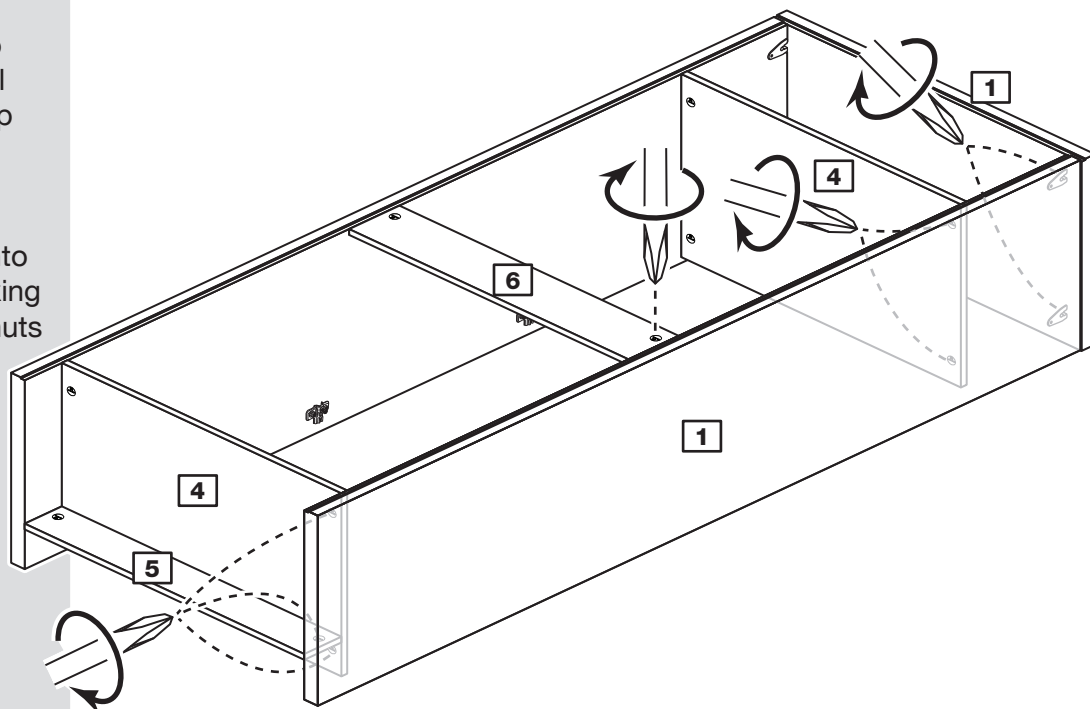
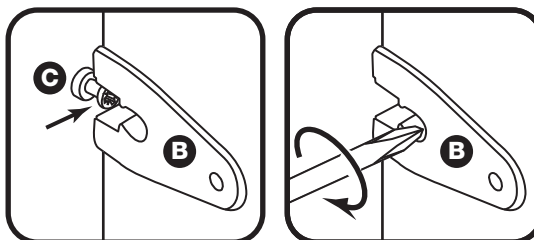

Assembly Instructions

Step 10

Fit the back panel

a: Square up the unit by making sure that measurement **x** to **x** equals **y** to **y**.

b: Place the back **9** onto the unit, coloured surface facing down.

Note: The back must be positioned so that it is central on the unit.

Nail **D** around the outside edges of the back **9**.

Note: Nails should try to be spaced out evenly.

Stand the unit up for the next stage.



Warning: The robe is heavy. Lift with care.

a: The measurement from top corner X to bottom corner X must be equal to the measurement from top corner Y to bottom corner Y

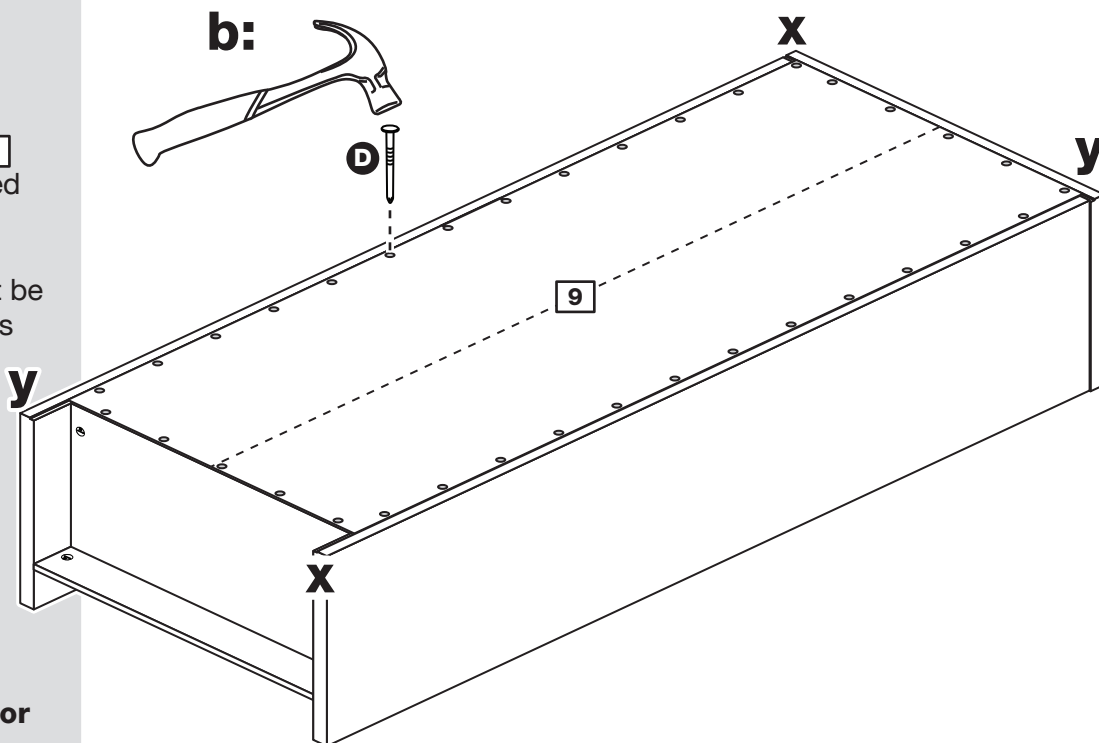

Assembly Instructions

Step 11

Fit the hanging rail

Push the hanging rail **7** into the rail holders **E** fitted to the side panels.

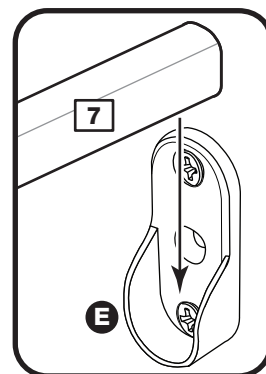
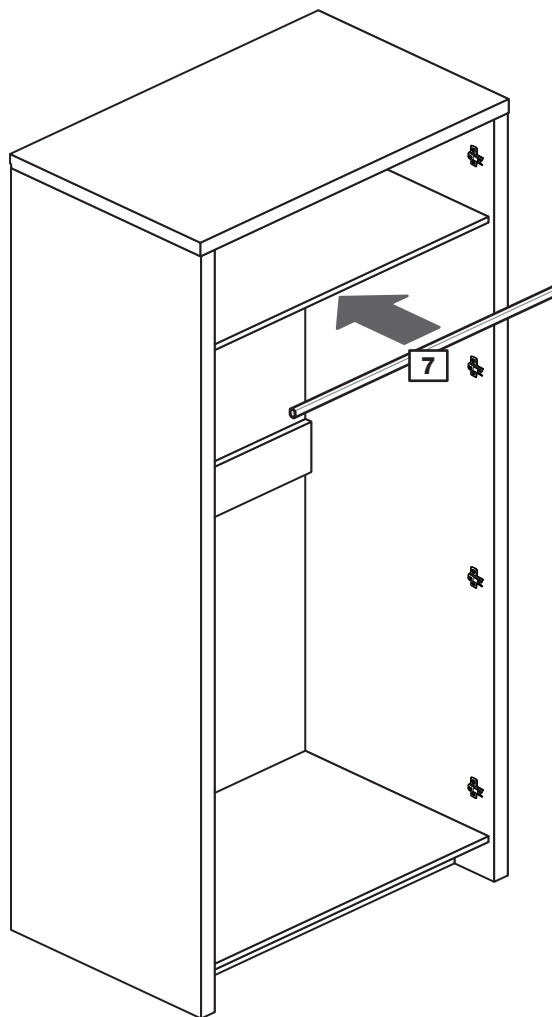

Step 12

Prepare the 2 doors

Push fit 4 hinges **M** into each of the doors **8**.

Secure each hinge with 2 screws **F**.

Note: Before securing with the screws, make sure that the hinges are positioned at 90 degrees with the front edge of the door.

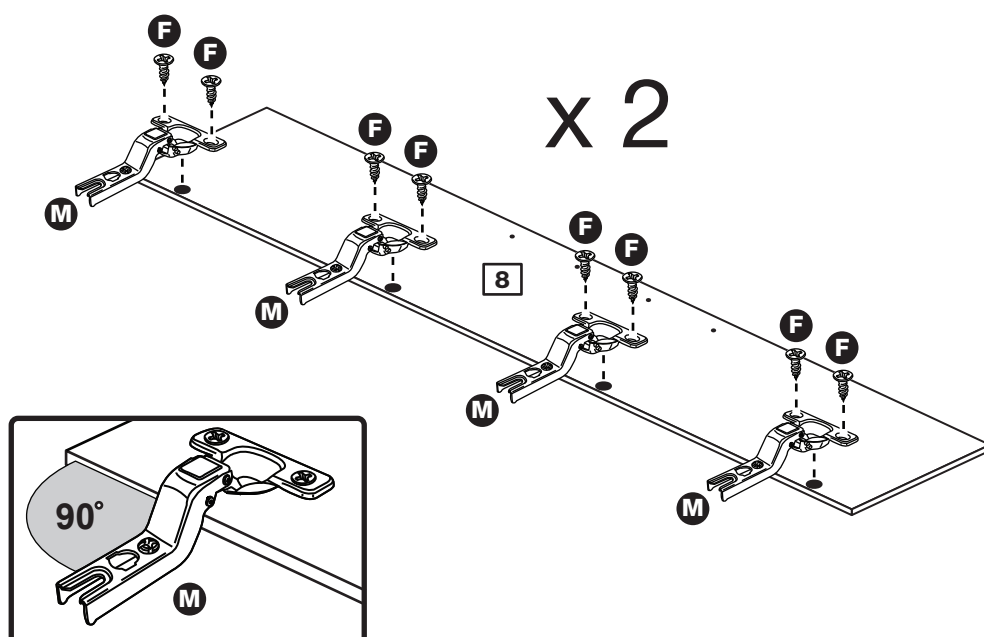

Assembly Instructions

Step 13

Drill 2 handle holes in each of the doors

Important: Please follow these instructions carefully.

Lay the 2 doors **8** down onto a smooth surface.

Check that the hinges and holes are in the same place as the diagrams.

Note: We recommend the use of a small piece of waste wood, placed behind the holes while drilling, to reduce the possibility of any breakout.

Using the pilot holes in the rear face of the door, drill through the 2 holes indicated opposite, using a 2.5mm diameter drill.

Turn the door over and open out the 2.5mm holes that you have just drilled by drilling back through them with a 5mm drill.

IMPORTANT

Carefully choose which 2 holes you need to drill in each door

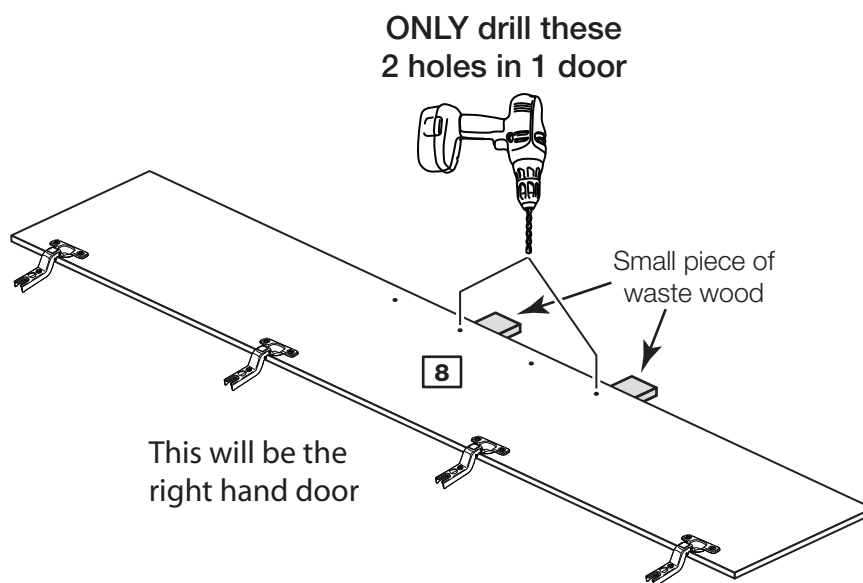
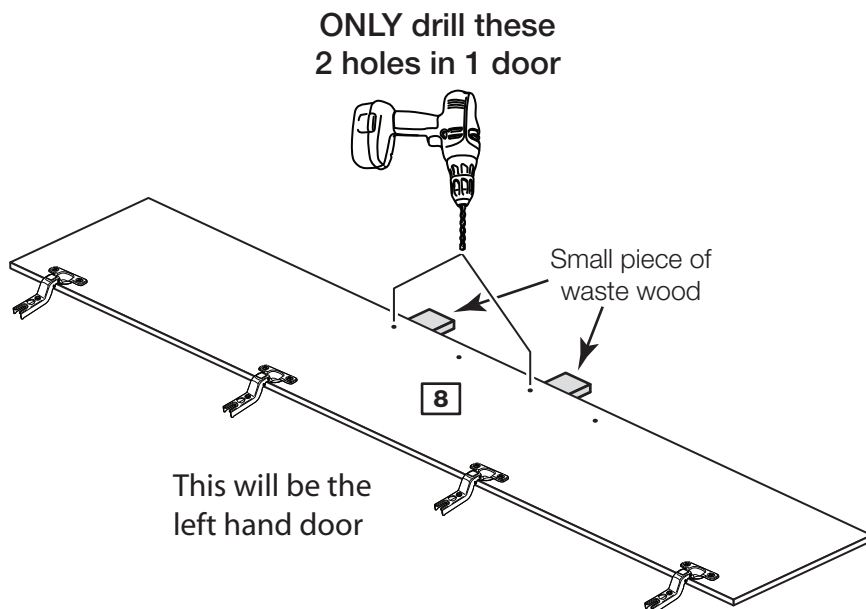

Assembly Instructions

Step 14

Fit doors and handles

Note: The easiest way to attach each door **8** is to fit the top hinge first, then align and fit the other hinges.

a: Push the hinge **M** onto the front part of the hinge plate **L**. The recess at the bottom of screw B goes into the slot in the hinge plate.

b: Keep the hinge **M** FLAT against the hinge plate **L** as you slide it across as far as it will go. Tighten screw A.

c: The hinge **M** must be flat against the hinge plate **L** prior to any adjustment.

d: The hinge **M** must NOT be AT AN ANGLE to the hinge plate **L** when assembled. This would indicate that the recess at the bottom of screw B had not located in the slot in the hinge plate and the hinge would not be secure. Remove the hinge from the hinge plate and then re-assemble being careful to follow instructions a-c.

e: Attach a handle **N** to each door **8** using 2 screws **I**.

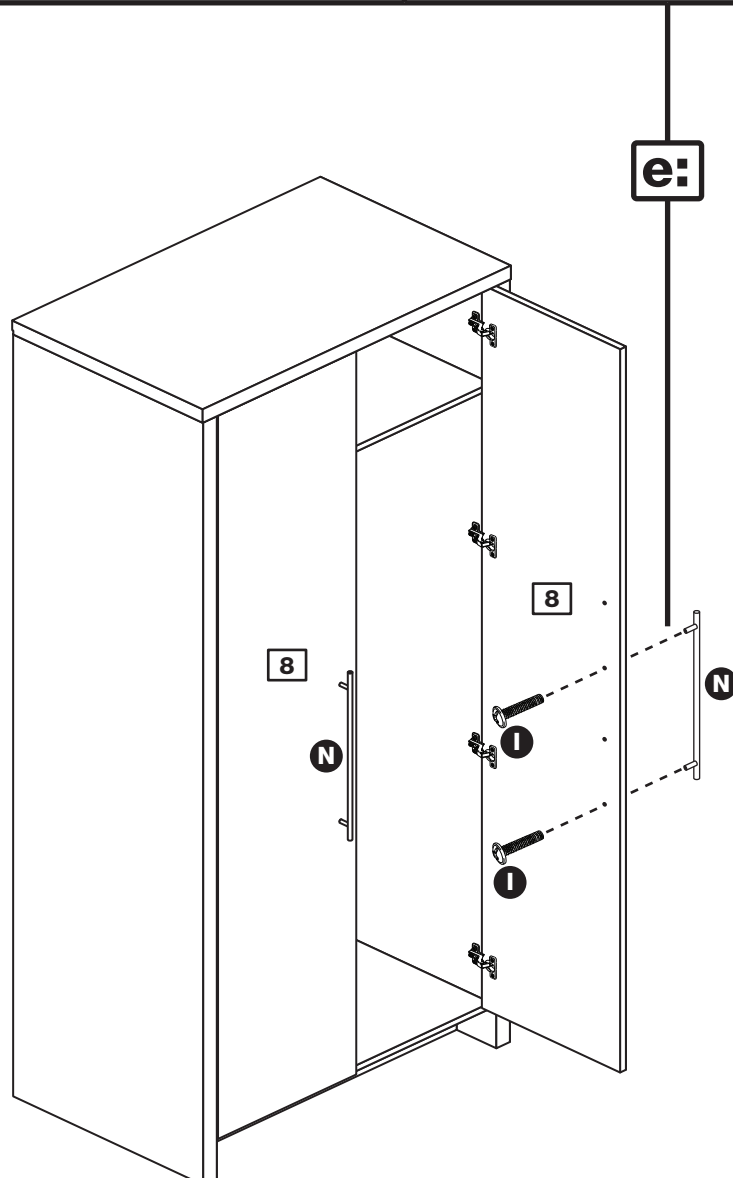
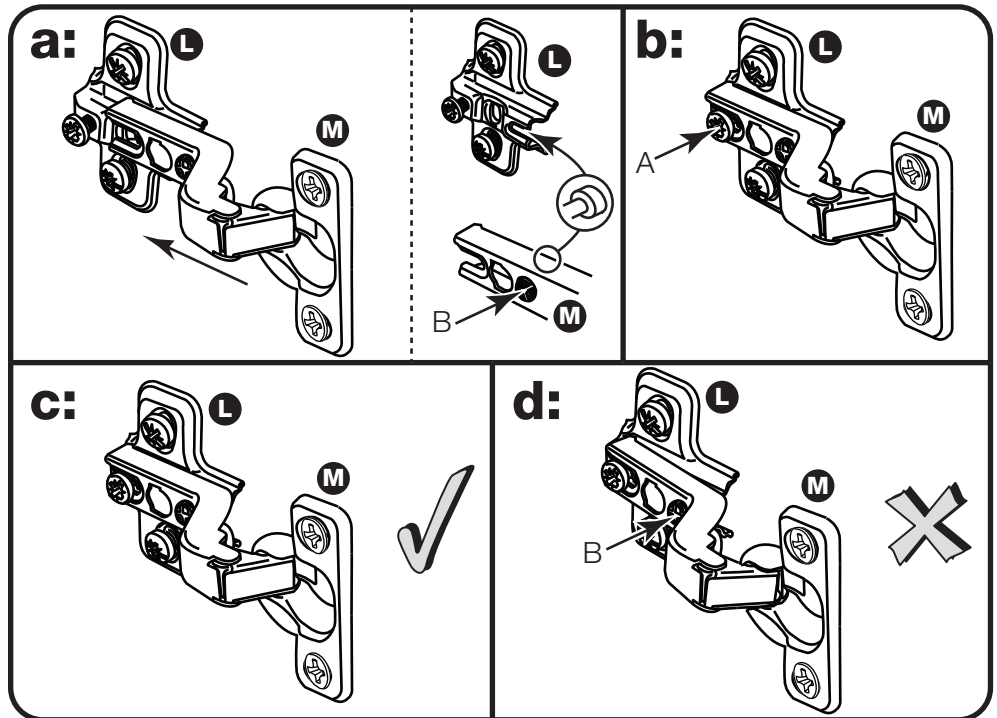

Assembly Instructions

Step 15

Adjust the doors if needed

a: Before adjusting the doors, use a spirit level to check the base (or top) of the unit is level, front-to-back and side-to-side in the 3 positions shown. Use suitable packing pieces (not supplied) to make the unit level BEFORE making any adjustment to the hinges, as shown.

b: Height adjustment.

Loosen screws A on hinge plates and move door up or down as required. Retighten screw A.

c: Forward and Back adjustment.

Loosen screw B on hinge plate and move door in or out as required. Retighten screw B.

d: Sideways adjustment.

To move door 'out' loosen screw C. To move door 'in' tighten screw C.

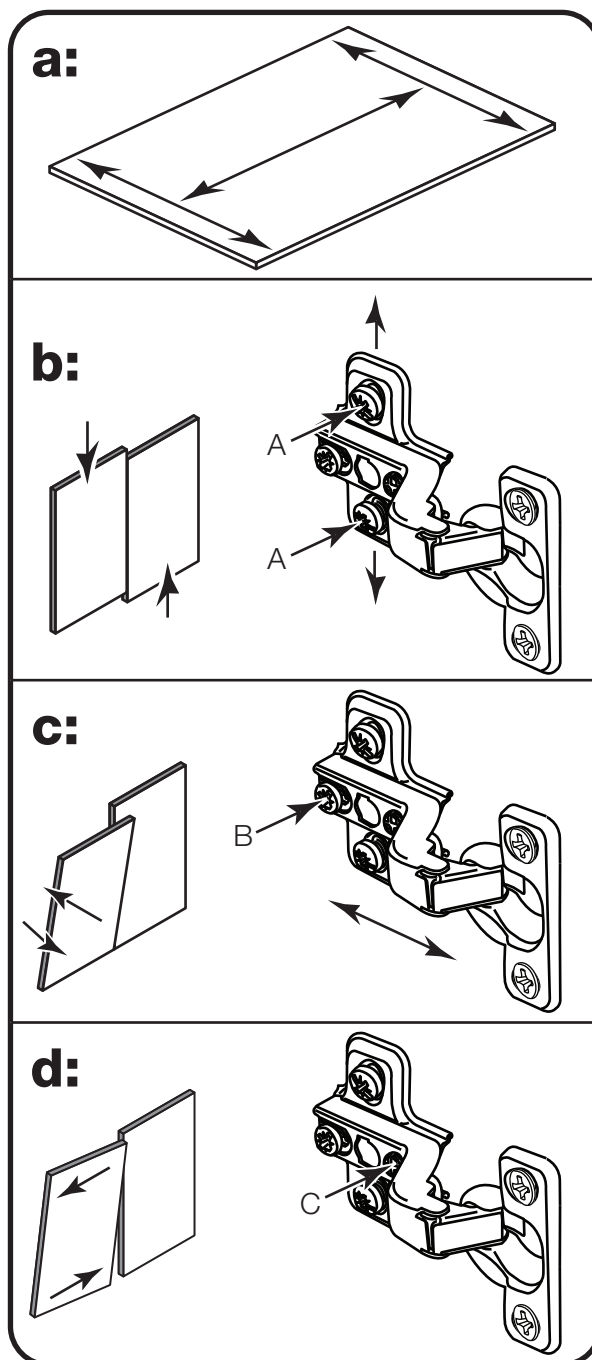

Assembly Instructions

Step 16

Fit the bracket

To prevent possible overbalancing, we recommend that this unit is secured to a suitable wall by use of the bracket **K** fitted to the top of the unit.

Fixings are not supplied, as they will need to suit the wall type and the length of screw will depend on the distance from the back of the unit to the wall.

Fix the bracket **K** loosely onto the top of the unit using screw **J** and mark the wall for the wall fixing.

Swivel the bracket **K** away from the wall and drill a hole in the wall using a suitable drill bit and fit your wall fixing.

Swivel the bracket **K** back and fix the bracket to the wall, then tighten screw **J**.

Note: Take care when drilling the wall that you do not drill into any pipes, wires etc. If in doubt, consult an expert.



Warning: The unit is heavy. Lift with care.

Assembly is complete

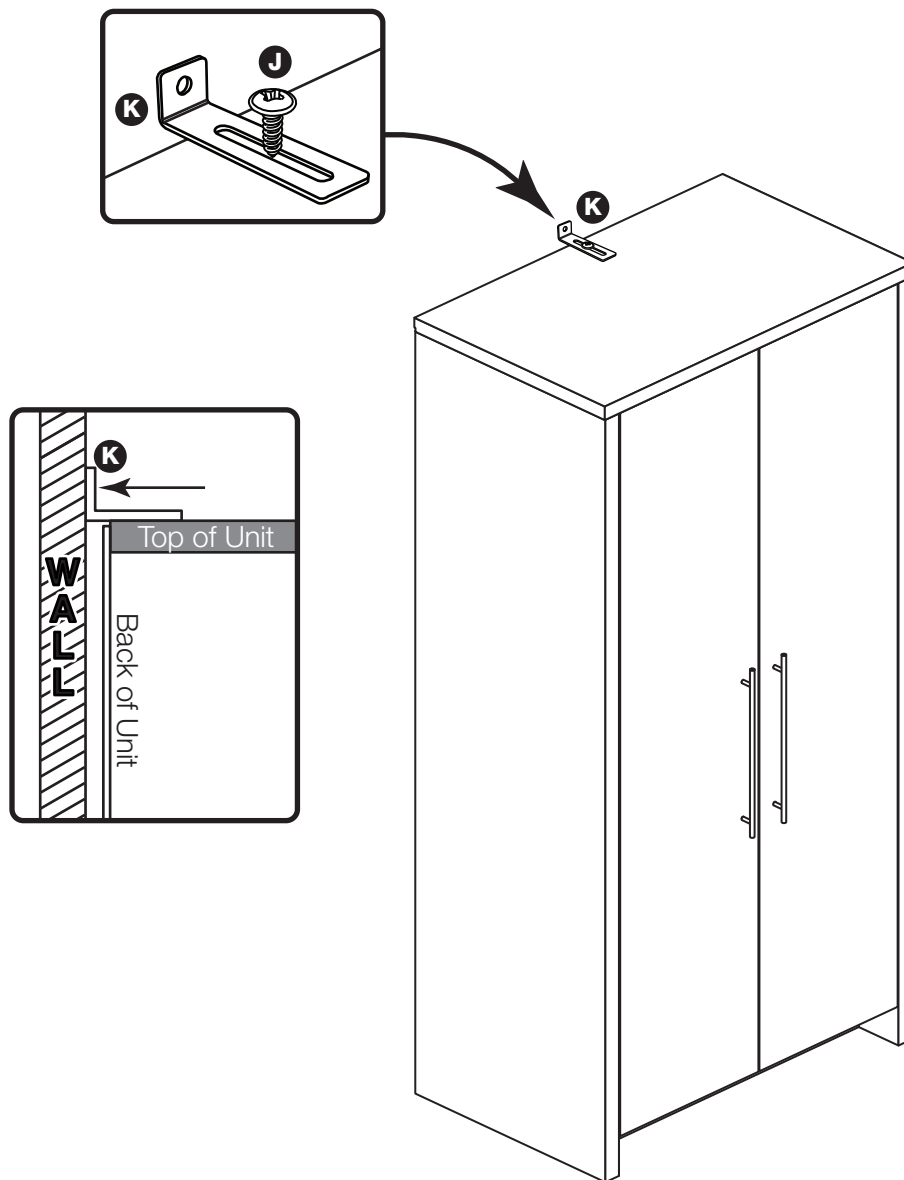

If you need help or have damaged or missing parts, call the **Customer Helpline: 08456 400800** and quote the reference numbers on the component pages.

Argos Ltd, 489-499 Avebury Boulevard, Central Milton Keynes, MK9 2NW

