

Dishwasher

Installation & User Instructions – Please keep for future reference

255/8189

262/6482

226/9430

BUSH

Real Life Technology



Important – Please read these instructions fully before installing or using

These instructions contain important information which will help you get the best from your appliance and ensure safe and correct installation, use and maintenance.

If you need help or have damaged or missing parts, call the Customer Helpline: 0345 600 4632

Contents

Safety Information	2-3
Parts	4
Installation	5-7
Water supply connection	5
Drain hose connection	5
Position the appliance	5
Water pressure	6
Electrical connection	7
User Instructions	8-15
Before first use	8
Water softener	8
Rinsing aid	9
Detergent	10
Loading your appliance	11-13
Wash cycle table	14
Using your appliance	15-16
Care and Maintenance	17
General	17
Trouble Shooting	18
Error codes	18
Technical Specification	19
Disposal information	20
Guarantee	21



Product codes

DWFS126W	WHITE
DWFS126S	SILVER
DWFS126B	BLACK



Safety Information

Important – Please read these instructions fully before installation

Before use

The installation of this appliance is best carried out by 2 people.

- Dispose of all packaging carefully and responsibly.
- The appliance is designed for **indoor use only** and must be protected from rain, moisture and extreme temperature variations.
- This appliance is designed for household use. **Do not** use the appliance for industrial and commercial use, or any other purpose.
- The appliance **MUST** be positioned on a firm level base.
- **Do not** place the appliance near a heat source or in direct sunlight.
- Only suitable household utensils should be placed in the dishwasher. Avoid utensils that are non-heat-resistant, metal decorated, etc.
- **Do not** use detergent not designed for dishwasher. This may damage the appliance.
- **Do not** spray water on the appliance. It may cause electrical parts failure or electric shock.
- **Do not** stand or sit on the door when it is open. It may cause deformation or failure of your dishwasher. The appliance could tip forward.
- **Do not** put any heavy objects on top of the appliance. It will damage the appliance.
- This appliance is fitted with a safety function that automatically stops the operation of the dishwasher when it is exposed to heavy disturbance on its mains.
- The appliance is to be connected to the water supply using new hose set and that old hose set should not be used.
- The door should not be left in open position since this could present a tripping hazard.
- This appliance must be positioned so that the plug is accessible.
- This appliance is intended to be used in household and similar applications such as:
 - staff kitchen areas in shops, offices and other working environments;
 - farm houses;
 - by clients in hotels, motels and other residential type environments;
 - bed and breakfast type environments.

During use

- This appliance is not intended for use by persons (including children) with reduced physical, sensory or mental capabilities, or lack of experience and knowledge, unless they have been given supervision or instruction concerning use of the appliance by a person responsible for their safety. Children should be supervised to ensure that they do not play with the appliance.
- This appliance is not intended for use by young children or infirm persons unless they have been adequately supervised by a responsible person to ensure that they can use the appliance safely. Young children should be supervised to ensure that they do not play with the appliance.
- **Do not** touch the visual heating element during or immediately after use.
- **Do not** operate your dishwasher unless all enclosure panels are properly in place. Open the door carefully if the dishwasher is operating, there is a risk of water squirting out.
- **WARNING:** Knives and other utensils with sharp points must be loaded in basket with their points down or placed in a horizontal position. Avoid damage to the door seal.
- Load plastic items so that they do not come into contact with the visible heating element.
- Dishwasher detergents are strongly alkaline, they can be extremely dangerous if swallowed. Avoid contact with skin and eyes and keep children away from the dishwasher when the door is open.
- The door should not be left open, since this could increase the risk of tripping.
- Keep detergents away from children.
- **Do not** attempt to repair the appliance yourself. Contact the Customer Helpline: 0345 600 4632.



Safety Information

Important – Please read these instructions fully before installation

- This appliance is intended to be used in household and similar applications such as:
 - staff kitchen areas in shops, offices and other working environments;
 - farm houses;
 - by clients in hotels, motels and other residential type environments;
 - bed and breakfast type environments.
- This appliance can be used by children aged from 8 years and above and persons with reduced physical, sensory or mental capabilities or lack of experience and knowledge if they have been given supervision or instruction concerning use of the appliance in a safe way and understand the hazards involved. Children shall not play with the appliance. Cleaning and user maintenance shall not be made by children without supervision.
- To protect against the risk of electrical shock, do not immerse the unit, cord or plug in water or other liquid.
- Please unplug before cleaning and maintenance the appliance.
- Use a soft cloth moisten with mild soap, and then use a dry cloth to wipe it again.
- If the supply cord is damaged, it must be replaced by the manufacturer, its service agent or similarly qualified persons in order to avoid a hazard.

Parts

Please familiarize yourself with the parts and accessories listed below

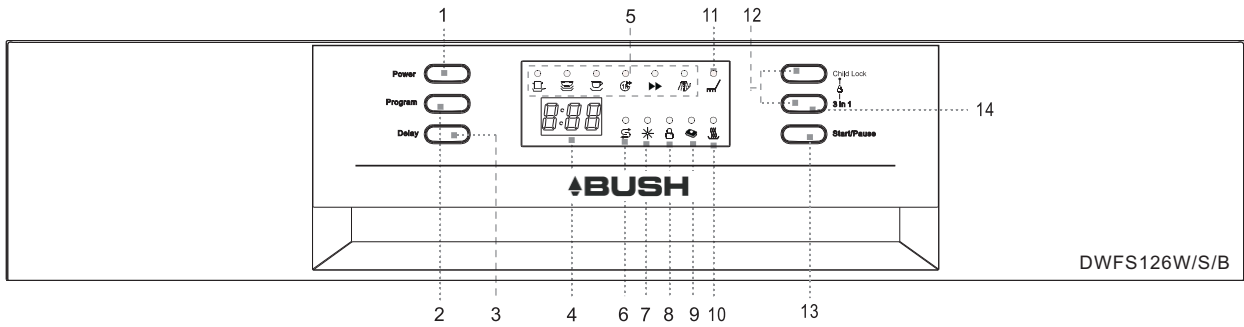

- | | | |
|----------------------------|-------------------------------|-----------------------------|
| 1、 Power button | 6、 Salt refill indicator | 11、 Washing light indicator |
| 2、 Program select button | 7、 Rinse aid refill indicator | 12、 Child lock button |
| 3、 Delay start button | 8、 Child lock indicator | 13、 Start \pause button |
| 4、 LED display | 9、 3 in 1 indicator | 14、 " 3 in 1 " button |
| 5、 Program indicator light | 10、Drying light indicator | |

Front view

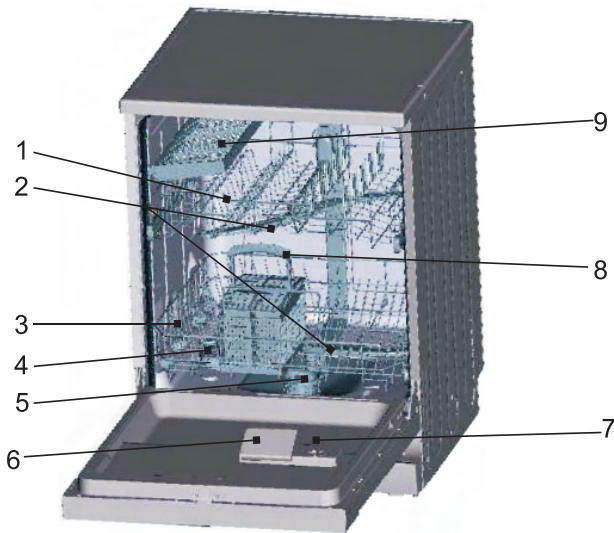

- 1 Upper basket
- 2 Spray arms
- 3 Lower basket
- 4 Water softener
- 5 Filters
- 6 Detergent dispenser

Back View

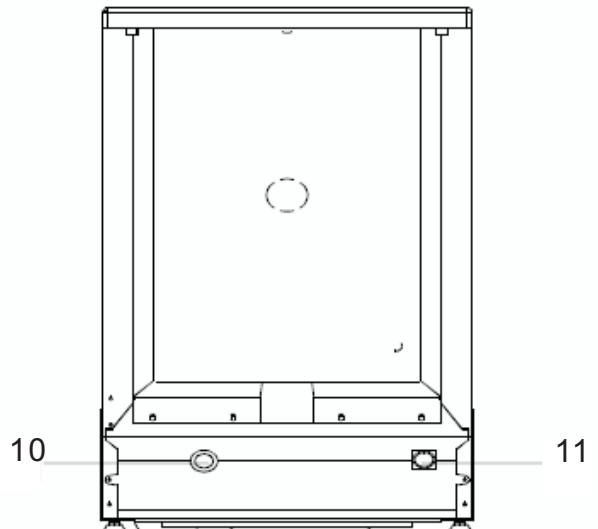

- 7 Rinse aid dispenser
- 8 Cutlery basket
- 9 Cup holder
- 10 Inlet pipe connector
- 11 Drain pipe connector

Accessories included



Instructions x 1



Hose x 1



Salt Filler x 1



Inlet Hose x 1

Installation

Water supply connection



Caution: 2 people are required to unpack and handle the appliance, it is recommended that gloves are worn.

- Carefully remove all packaging materials including the foam base, dispose of correctly.
- Connect the cold water supply hose to a threaded $\frac{3}{4}$ " connector and make sure that it is fastened tightly in place.
- If the water pipes are new or have not been used for an extended period of time, let the water run to make sure that the water is clear. This will prevent the water inlet to be blocked and damage the appliance.

WARNING:
Please close the hydrant after using.

Drain hose connection

1. Make a hooked end at the end of drain hose with the plastic U-bend fitting (provided). The hooked end should be dropped into a drainage standpipe between 50cm and 110cm from the floor level.
2. The free end of the hose must not be immersed in water to avoid the flow back.
3. You may connect the water inlet hose onto the kitchen sink tap. You must obtain a correct adaptor to match the inlet hose connector for a secure connection. However, permanent plumbing is recommended.
4. If leakage is observed, immediately shut off the water supply and check the hose connections fully. Tighten connections if necessary.

Position the appliance

1. The dishwasher must be installed on a solid level surface.
2. Position the appliance in the desired location. The back should rest against the wall behind it, and the sides along the adjacent cabinets or wall. The water supply and drain hoses can be positioned either to the left or right side to facilitate proper installation.
3. To level the dishwasher, adjust the 4 level screws (feet) under the dishwasher.

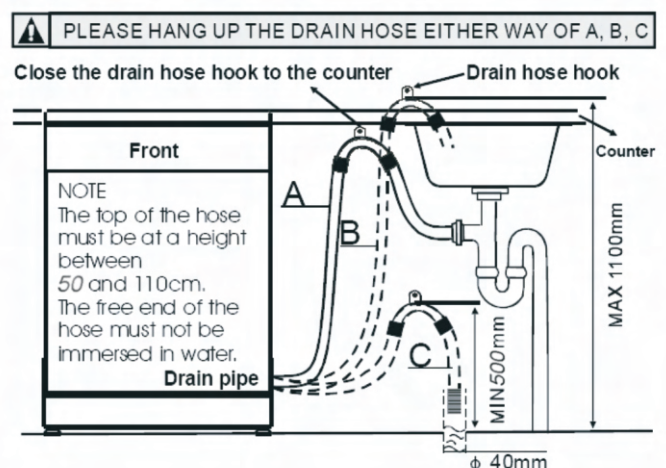
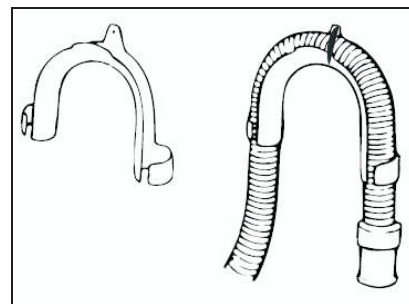
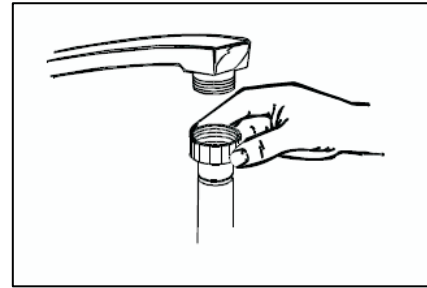

Installation

Water pressure

For best operating results, incoming water pressure should be between 0.04 and 1 Mpa.

Your dishwasher cleans by spraying a mixture of hot clean water and detergent (under pressure) against the soiled surface of dishes. The water is pumped through a rotating spray arm, drained through a filter removing food and soiled particles and pumped back through the spray arm.

Note: Hard water conditions will adversely affect the performance of your dishwasher. To minimise this condition, it is recommended to periodically operate/rinse the dishwasher in empty condition using 1 cup of white vinegar (at least once a week).



Important: Once you open the water supply (even if it is closed immediately thereafter), the water inlet hose will be pressurised.

Installation

Electrical connection



Any electrical work that is required to install this appliance **MUST** be carried out by a qualified electrician.



Warning: THIS APPLIANCE MUST BE EARTHED

Before making any electrical connections, ensure that:

- Electrical safety is only guaranteed when the earth system of your house is in accordance with the related local regulations.
- Do not bend, stretch or pull the supply cable to avoid electric shock.
- Ensure the power socket is suitable for the maximum power of the appliance (fuses in the power circuit must be 13 amp).
- The supply voltage should be the same as that indicated in the technical specifications and the appliance rating plate.
- The appliance should be earthed and in compliance with the applicable law.
- When installed, the power socket must be within easy reach.
- If the socket outlets in your home are not suitable for the plug supplied with this unit check with a qualified electrician for replacement.
- The use of adapters, multiple connectors or extension cables are not recommended.
- The appliance must be connected to a 220-240 volt 50Hz AC supply by means of a three pin socket, suitably earthed and protected by a 13 amp fuse.
- Should the fuse need to be replaced, a 13 amp fuse approved to BS1362 must be used.
- The plug contains a removable fuse cover that must be refitted when the fuse is replaced. If the fuse cover is lost or damaged, the plug must not be used until a replacement cover has been fitted or the plug is replaced.
- A damaged plug should be cut off as close to the plug body as possible, the fuse should be removed and the plug disposed of safely.

Plug replacement (UK & Ireland only)

Should you need to replace the plug; the wires in the power cable are coloured in the following way:

Blue – Neutral 'N'

Brown – Live 'L'

Green & Yellow – Earth 'E'

As the colours of the wires in the power cable may not correspond with the coloured markings identifying the terminals in your plug, and proceed as follows:

The green & yellow wire must be connected to the terminal in the plug that is marked with the letter E or by the earth symbol.

The blue wire must be connected to the terminal that is marked with the letter N.

The brown wire must be connected to the terminal that is marked with the letter L.

If power supply cord is damaged, it must be replaced by the manufacturer or its service agent or a similar qualified person in order to avoid a hazard.

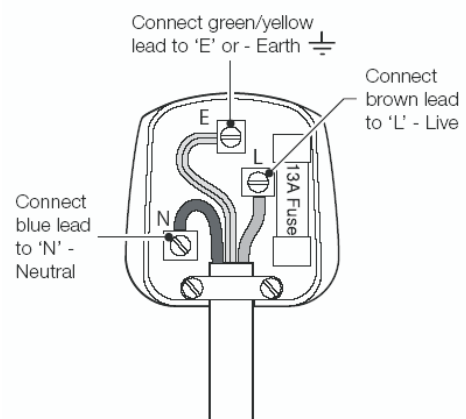

User Instructions

Before first use

Before using your appliance for the first time:

- Set the water softener
- Add 2kg dishwasher salt and then full fill the salt container with 500ml water
- Fill the rinse aid dispenser
- Fill in detergent

Water Softener

Salt consumption

This unit will automatically consume the suitable quantity of salt. It is fit for all type of area. When you run the dishwasher, the water softener will be full of water. Therefore, adding softening salt should always be done immediately before you start the unit. You should check the salt level to ensure it is enough before starting on of the complete washing programmes. If it is necessary, please ensure 500ml of water has been added. You can put up to 2kg salt in the water softener.

Loading the salt into softener

1. Remove the lower basket and then unscrew and remove the cap from the salt container. (Fig 1)
2. Place the end of the funnel(supplied) into the hole and introduce about 2 kg of dishwasher salt.
3. Full fill the salt container with water. It is normal for a small amount of water to come out of the salt container. (Fig 2)
4. Screw the cap tightly back clockwise.
5. Immediately after filling the salt, a washing cycle should be started (Pre-rinse or rapid program suggested). Otherwise the filter system or pump may be damaged by salty water.



Important:

- Only use dishwasher salt
- Add the salt again when the salt warning light at control panel is on.
- It takes time to dissolve the salt so the salt warning light may still come on even the salt container is filled.

User Instructions

Before first use

Rinsing Aid

A rinsing aid is specially formulated to rinse away food and detergent residues that can be left behind on your dishes. Use regularly, a rinse aid will automatically provide you with cleaner dishes every time you wash.

Loading the rinsing aid

1. Turn the dispenser cap to 'open' arrow and lift it out.
2. Fill the rinsing aid slowly into the container until it just reaches the bottom of the filling cap
3. Replace the cap by turning to 'close' arrow.

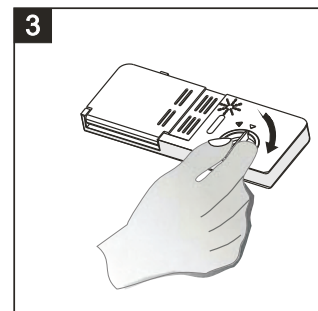
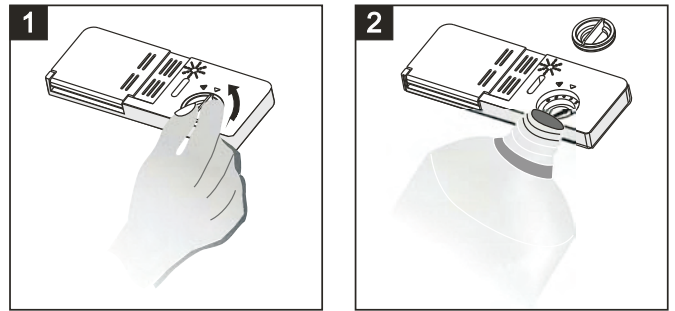

There is a rinse-aid indicator on the dispenser

- Full
- 3/4 Full
- 1/2 Full
- 1/4 Full – Require refill
- Empty – Require refill

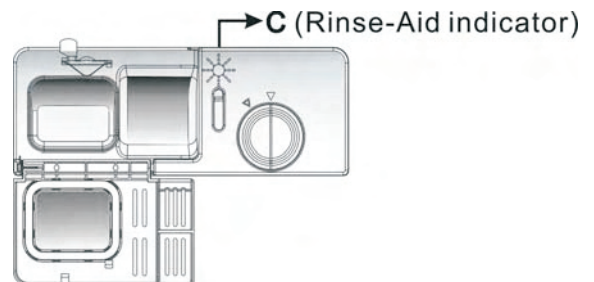

Adjusting Rinse Aid Dispenser

The rinse aid dispenser has four of six settings. Always start with the dispenser set on "4". If spots and poor drying are problems, increase the amount of rinse aid dispensed by removing the dispenser lid and rotating the dial to "5". If the dishes still are not drying properly or are spotted, adjust the dial to the next higher number until your dishes are spot-free. The dose is factory set in position 5.

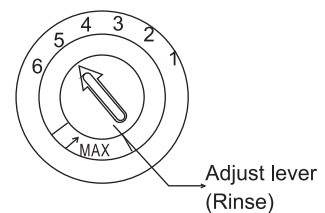

Note:

Increase the dose if there are drops of water or lime spots on the dishes after wash. Reduce the dose if there are sticky whitish stains on your dishes or a bluish film on glassware or knife blades.

User Instructions

Before first use

Detergent

Use only detergent specifically made for use in dishwashers, as other types may damage the dishwasher.

The dispenser must be filled before the start of each wash cycle following the instructions provided in the wash cycle table. Your dishwasher uses less detergent and rinse aid than conventional dishwasher. Generally, only one tablespoon of detergent is sufficient for a normal wash load. Heavily soiled items need more detergent. Always add the detergent just before the start of the dishwasher, otherwise it could get damp and will not dissolve properly.

Loading the detergent

1. The detergent dispenser (recessed area) located at the inside of the door.
2. Open the lid by pressing the release button.
3. Pour the detergent. The marking indicates the dosing levels:
 - A** – Detergent for main wash cycle. 'MIN' means approximately 20g of detergent.
 - B** – Detergent for pre-wash cycle, approximately 5g of detergent.
4. Close the lid until it locks in place.

Note: follow the detergent manufacturer's guidelines. Dishwasher detergent is corrosive! Keep it out of reach of children.

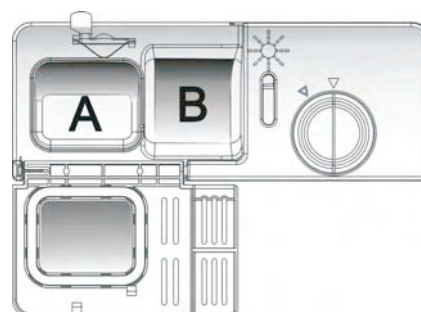
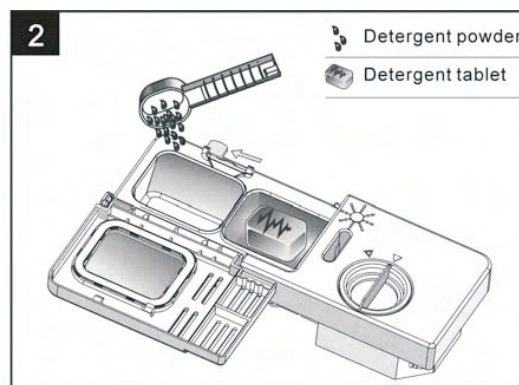
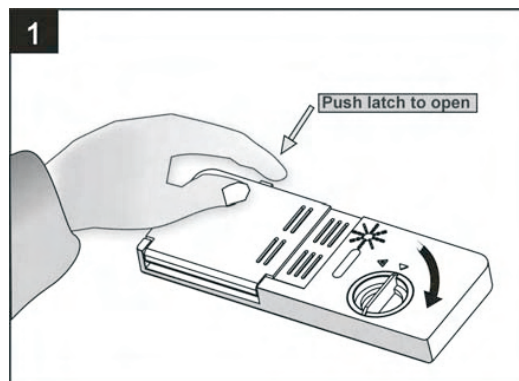

User Instructions

Loading your appliance

Preparing your dishes prior washing

- Scrape off all food residuals from the dishes.
- Remove excessive quantities of oil or grease.
- Empty any liquids from glasses and cups.
- Dishes with dried-on foods are more difficult to wash and may not come clean in a normal wash cycle.
- Arrange all items with recessed or curved sections on a slant to drain water away.
- Cups, pots and glasses etc should be placed upside down.

Loading the upper basket

The upper basket is designed to hold more delicate and lighter dishware such as glasses, coffee and tea cup and saucers, plates, small bowls and shallow pans (as long as they are not too dirty). Position the dishes and cookware so that they do not get moved by the spray of water.

Adjusting the upper basket

The height of the upper basket can be adjusted in order to create more space for large utensils both for the upper/lower basket. The height of the upper basket can be adjusted by placing the wheels on different height of the rails. Long items, serving cutlery, salad servers and knives should be placed on the shelf so that they do not obstruct the rotation of the spray arms. The shelf can be folded back or removed when not in use.

Upper Basket

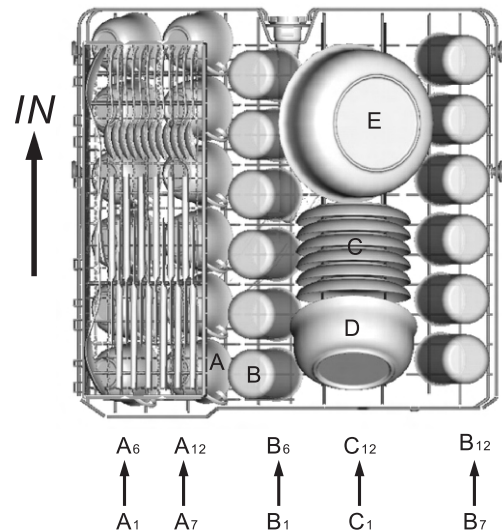

Upper basket	
Type	Item
A	Cup
B	Glass
C	Saucer
D	Serving bowl
E	Serving bowl

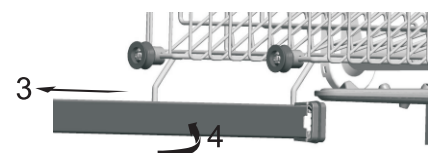
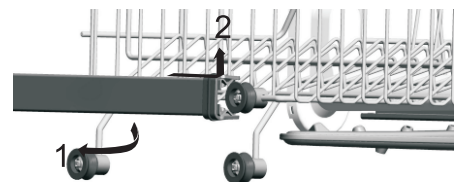

User Instructions

Loading your appliance

Loading the lower basket

- Put large items which are most difficult to clean into the lower basket.
- Locate sharp items so that they are not likely to damage the door seal.
- Load sharp knives with the handles up to reduce the risk of injuries.
- Do not load plastic items unless they are marked "dishwasher safe" or the equivalent.
- Do not load glasses over the dish rack pins.
- Glasses loaded over dish rack pins are not properly supported and are likely to get damaged.
- Items with wooden or bone handles and items joined together with glue are unsuitable as they cannot resist hot water.

Folding spikes

For better stacking of pots and pans, the spikes can be folded down as shown in the diagram.

Cutlery Basket and Fork shelf

Cutlery should be placed in the cutlery basket with handles at the bottom: If the basket has side baskets, the spoon should be loaded individually into the appropriate slots, especially long utensils should be placed in the horizontal position at the front of the upper basket.

Cutlery basket/Fork shelf	
Type	Item
1	Tea spoons
2	Dessert spoons
3	Soup spoons
4	Gravy ladle
5	Serving fork
6	Forks
7	Knives
8	Serving spoons

Lower Basket

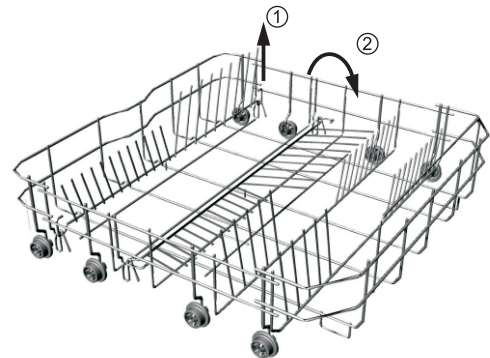
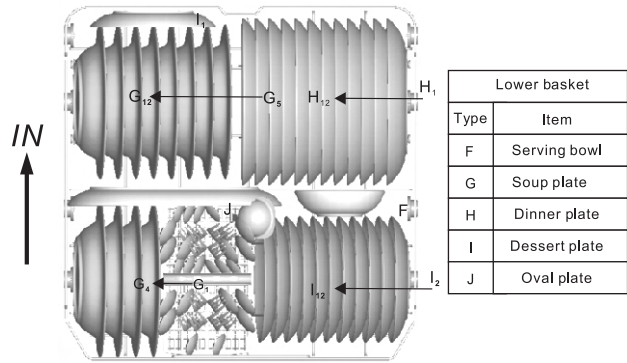

Cutlery basket

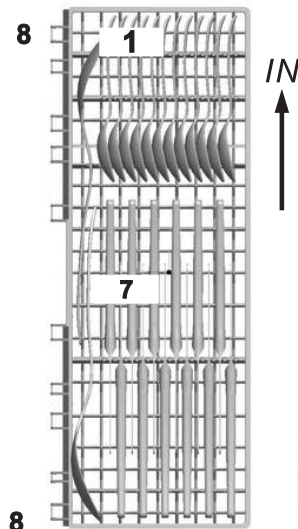
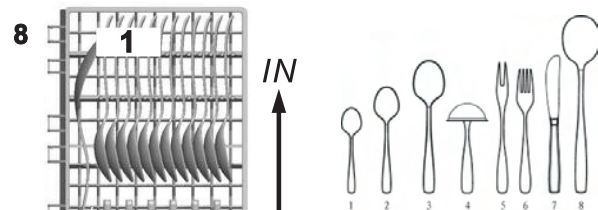
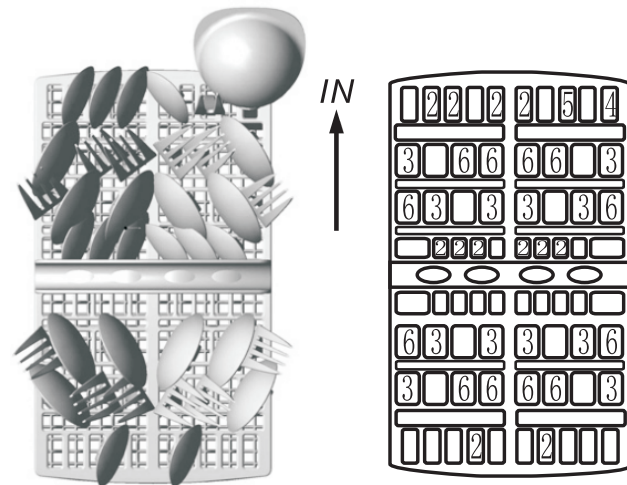

▲ WARNING!

Do not let any item extend through bottom

User Instructions

Loading your appliance

NOTE: For ease of loading/unloading large size dinner plates from the dish rack it may be necessary to remove the cutlery basket. When loading/unloading is complete, return the cutlery basket to its original position.

Warning

- Do not touch the heating element during or immediately after use.
- Do not tamper with controls.
- Do not abuse, sit or stand on the open door or dish-rack of the dishwasher. The machine may topple over.
- Protect cables and hoses from high temperatures.
- To reduce the risk of injury, do not allow children to operate or play with the dishwasher.

User Instructions

Wash cycle table

<i>Program</i>	<i>Cycle Selection Information</i>	<i>Description of Cycle</i>	<i>Detergent pre/main</i>	<i>Running time(min)</i>	<i>Energy (Kwh)</i>	<i>Water (L)</i>	<i>Rinse Aid</i>
Intensive	For heaviest soiled crockery, and normally soiled pots, pans, dishes etc with dried on soiling.	Pre-wash Main wash(60°C) Rinse 1 Rinse2 Hot rinse Drying	5/25 (or 3 in 1)	180	1.30	16	★
ECO (*EN 50242)	Standard daily cycle for normally soiled loads, such as pots, plates, glasses.	Pre-wash Main wash (46°C) Hot rinse Drying	5/25 (or 3 in 1)	172	0.92	13	★
Light	For lightly soiled crockery and glass	Pre-wash Main wash(45°C) Hot rinse Drying	5/20 (or 3 in 1)	137	0.85	14	
60 min	For lightly and normally soiled plates and pans for every day.	Hot rinse 1 Hot rinse 2 Hot rinse(60°C) Drying	5/20	60	0.95	10	
Rapid	A shorter wash for lightly soiled loads and quick wash	Main wash(40°C) Hot rinse	15	39	0.50	7	
Pre-Rinse	To rinse dishes that you plan to wash later that day	Pre-wash	/	11	0.01	4	★

User Instructions

Using your appliance

To operate the dishwasher:

1. Draw out the lower and upper basket, load the dishes and push them back. It is recommended to load the lower basket first, then the upper one (see the section entitled "Loading the Dishwasher").
2. Pour in the detergent (see the section entitled "Salt, Detergent and Rinse Aid").
3. Insert the plug into the socket.
4. Make sure that the water supply is turned on to full pressure. Close the door, press the power button.
5. Continue to press "program" button to select the desired "wash cycle". (See the section entitled "Wash Cycle Table"). Press "start/pause" button to start the program.

NOTE: A click could be heard when the door is closed perfectly. When the washing is over, you can shut off the unit by pressing "Power" button.

Program Selection Change

1. A cycle that is underway can only be modified if it has only been running for a short time. Otherwise, the detergent may have already been released, and the appliance may have already drained the wash water. If this is the case, the detergent dispenser must be refilled (see the section entitled "Fill in the Detergent").
2. Press "Power" button to turn it off. And turn it on by press "power" button again, then you can change the program to the desired cycle setting (see the section entitled "wash cycle table"). Press "start/pause" button to start the washing program.

NOTE: Delay function:

After selecting the wash cycle program, you can set the desired delay time by pressing the delay button. It can be set up to 24 hour delay time. The dishwasher will start operation after the selected delay time is elapsed.

NOTE: Child safety lock function

To lock, press child lock button and 3 in 1 button at same time and hold for at least 3 seconds. The child lock indicator will flash 6 times and then illuminate.
To unlock, press child lock button and 3 in 1 button at the same time and hold for at least 3 seconds. The unit will get back to normal standby status and the child lock indicator will switch off.

NOTE : "3 in 1" function

"3 in 1" is a special designed program to use the 3 in 1 dishwasher tablet. You can buy the tablet in the high street. Add the tablet into the detergent box and do not need to fill the salt & rinse-aid. Press once on the 3 in 1 button and the indicator will illuminate. Then select the washing program as usual. To have the best result, it is strong suggested to add salt to the salt container for water softener. (see waster softener section)

NOTE:

If you open the door when washing, the machine pauses and sounds warning alarm, it displays E1. When you close the door, the machine will get back to the normal operation after 10 seconds.

Under different status, the program indicator will light in different combination:

The 6 programme lights show the state of the dishwasher:

- a) One of the programme lights on--> cycle running
- b) One of the programme lights blinking --> pause

User Instructions

Using your appliance

Program End

1. When the washing program is finished, it will sound 6 times and displays "--".
2. Open the door and remove all the dishes.
3. Turn off the unit by pressing the Power switch. Then close the door.
4. Shut down the water supply after using.

Special attention :

If all the indicator lights start to glimmer, the machine should be out of order. Please turn off the power and shut down the water supply. Then call the customer helpline.

Warning :

It is dangerous and not recommend to open the door during the washing operation. The hot water may come out and scald you while the door is open during the operation.

Care and Maintenance

General



Important: Always unplug the appliance from the power socket during cleaning and maintenance.

- Never use any sharp instruments or abrasive substances, soap, household cleaner, detergent or wax polish for cleaning.
- Clean the external surfaces with a damp soft cloth only. Never use abrasive products or solvents as it may damage the dishwasher.
- One of the factors that cause odour is the food that remains trapped in the seals. Periodic clean the seal with a damp sponge will prevent this from occurring.

The filter system consists of a main filter, coarse filter and fine filter.

- Main filter **(1)** - Food and soil particles trapped in this filter are pulverized by a special jet on the lower spray arm and washed down the drain.
- Coarse filter **(2)** - Larger items such as pieces of bones that could clog the drain are trapped in the coarse filter. To remove an item caught in this filter, gently squeeze the taps on the top of this filter and lift it out.
- Fine filter **(3)** - This filter holds soil and food residues in the sump area and prevents it from being re-deposit on the dishes during a cycle.

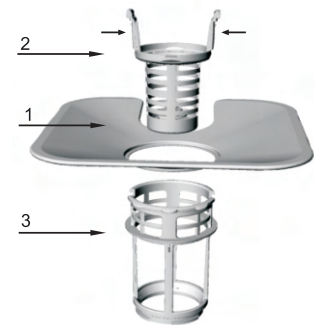

Cleaning the filter

1. Remove the filter from the bottom.
2. Clean the filter thoroughly under the running water tap.
3. Return the filter to its position

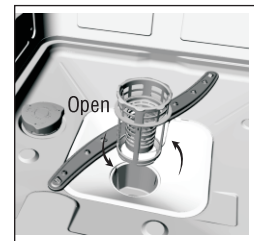

Warning: Under no circumstances may the dishwasher be used without filters.

Cleaning the spray arms

It is necessary to clean the spray arms regularly as hard water chemicals will clog the spray arm jets and bearings.

1. Remove the upper spray arm by screw off the nut clockwise and then remove the arm.
2. Remove the lower spray arm by pulling out the spray arm upward.
3. Wash the arms in soapy and warm water and use a soft brush to clean the jets.
4. Replace them after rinsing them thoroughly.

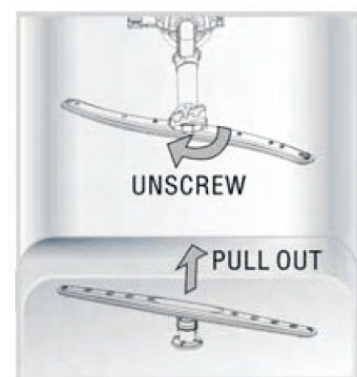

Not use for long period

If you are not using the dishwasher for a long period of time it is recommended to remove the plug, turn off the water supply and leave the door ajar to prevent odors from forming within the dishwasher.

Moving the dishwasher

If you need to move the dishwasher, try to keep it in vertical position. Avoid over tilting during the transportation.

Trouble Shooting

In the unlikely event of difficulties with your appliance please follow the trouble shooting guide below. If the problem persists, contact the retailer if the machine is still under guarantee. If the machine is out of guarantee, contact an approved service agent on **0345 600 4632**.

Problem	Possible cause	Solution
Dishwasher does not start	<ul style="list-style-type: none"> • The mains plug is not plugged in. • Door is not closed. • Water supply is not turned on. 	<ul style="list-style-type: none"> • Insert the mains plug. • Close the door. • Turn on the water supply.
Dishwasher does not load water	<ul style="list-style-type: none"> • Low water supply pressure. • The water supply hose is crimped or bent. • Filter is clogged. 	<ul style="list-style-type: none"> • Check the water pressure. • Ensure the hose is not crimped or bent. • Clean the filter.
Dishes not clean	<ul style="list-style-type: none"> • Improper or over loading. • Spray arm not rotating freely. • Not enough detergent and/or improper detergent is used. • Improperly prepared dishes. 	<ul style="list-style-type: none"> • Arrange dishes so spray action reaches all surfaces. Do not overload the dishwasher. • Make sure nothing (i.e. cutlery) is obstructing spray arm rotation. • Use proper dishwasher detergent. • Remove excessive food and liquids from dishes before loading.
Dishwasher does not drain	<ul style="list-style-type: none"> • The drain hose is crimped or bent. 	<ul style="list-style-type: none"> • Ensure the hose is not crimped or bent.
Noise	<ul style="list-style-type: none"> • Spray arm is knocking against an item in basket. • Items of crockery are loose in the wash cabinet. 	<ul style="list-style-type: none"> • Interrupt the program and re-arrange the items which are obstructing the spray arm. • Interrupt the program and re-arrange the items of crockery.
Unsatisfactory drying result	<ul style="list-style-type: none"> • Improper loading. • Too little rinse aid. • Dishes are removed too soon. • Wrong program has been selected. 	<ul style="list-style-type: none"> • Load as suggested in instructions. • Increase the rinse aid amount or refill the rinse aid dispenser. • Do not empty the dishwasher immediately after wash. • Washing temperature is lower in short program. Choose a program with a long washing time.

Error Codes	Meanings	Possible Causes
E1	Door open	The door is opened when the dishwasher is operating
E2	Water inlet	Water inlet malfunction
E3	Water drainage	Water drainage malfunction
E4	Temperature sensor	Temperature sensor malfunction
E5	Overflow/leakage	Overflow occurs/Water leakage occurs
E6	Water leakage	Water leakage occurs
E7	Heating element	Abnormal heating

Warning:

- If overflow occurs, turn off the water supply before contacting the customer helpline.
- If there is water in the base pan because of overflow or small leak, the water should be removed before restarting the dishwasher.

Technical specifications (according to EU Directive 1059/2010)

Brand	BUSH
Model	DWFS126W/B/S
Capacity	12 settings
Energy efficiency class ❶	A++
Annual energy consumption ❷	259 kWh
Energy consumption of the standard cleaning cycle	0.92 kWh
Power consumption of off-mode/left-on mode	0.35W/0.9W
Annual water consumption ❸	3640 litre
Drying efficiency class ❹	A
Standard cleaning cycle ❺	Eco
Program time for the standard cleaning cycle	172 min
Noise level	49 dB(A) re 1 pW
Freestanding/Built-in	Freestanding
Dimension	W600xD600xH845
Power consumption	1850W
Rated voltage	220-240V~50Hz
Water pressure(flow pressure)	0.04-1 MPa

NOTE

- ❶ A+++ (most efficiency) to D (least efficiency)
- ❷ Energy consumption "259" kWh per year, based on 280 standard cleaning cycle using cold water fill and the consumption of the low power nodes. Actual energy consumption will depend on how the appliance is used.
- ❸ Water consumption "3640" litres per year, based on 280 standard cleaning cycle. Actual water consumption will depend on how the appliance is used.
- ❹ A (most efficiency) to G (least efficiency)
- ❺ This program is suitable for cleaning normally soiled tableware, and that it is the most efficient programme in terms of its combined energy and water consumption for that type of tableware.

The above values have been measured in accordance with standards under specified operating conditions amount of detergent, etc.



This appliance complies with the following EEC directives:
2006/95/EEC Low voltage directive
2004/108/EEC EMC directive
2009/125/EC ERP directive

Disposal information



The symbol on the product or its packaging indicates that this product may not be treated as household waste. Instead it should be handed over to the applicable collection point for the recycling of electrical and electronic equipment. By ensuring this product is disposed of correctly, you will help prevent potential negative consequences for the environment and human health, which could otherwise be caused by inappropriate waste handling of this product. For more detailed information about recycling this product, please contact your local council office, your household waste disposal service or the shop where the product was purchased.

Guarantee



PRODUCT GUARANTEE

This product is guaranteed against manufacturing defects for a period of



Year

This product is guaranteed for twelve months from the date of original purchase.

Any defect that arises due to faulty materials or workmanship will either be replaced, refunded or repaired free of charge where possible during this period by the dealer from whom you purchased the unit.

The guarantee is subject to the following provisions:

- The guarantee does not cover accidental damage, misuse, cabinet parts, knobs or consumable items.
- The product must be correctly installed and operated in accordance with the instructions contained in this manual.
- It must be used solely for domestic purpose.
- The guarantee will be rendered invalid if the product is re-sold or has been damaged by inexpert repair.
- Specifications are subject to change without notice.
- The manufacturer disclaims any liability for the incidental or consequential damages.
- The guarantee is in addition to, and does not diminish your statutory or legal rights.
- In the event of a problem with the product within the guarantee period call the Customer Helpline on 0345 600 4632.

Guarantor: Argos Ltd
489 - 499 Avebury Boulevard
Central Milton Keynes
MK9 2NW