



Contact SAMSUNG WORLD WIDE

If you have any questions or comments relating to Samsung products, please contact the SAMSUNG customer care centre.

Country	Customer Care Centre ☎	Web Site
EIRE	0818 717100	www.samsung.com
U.K	0330 SAMSUNG (7267864)	www.samsung.com



PDP TV

user manual

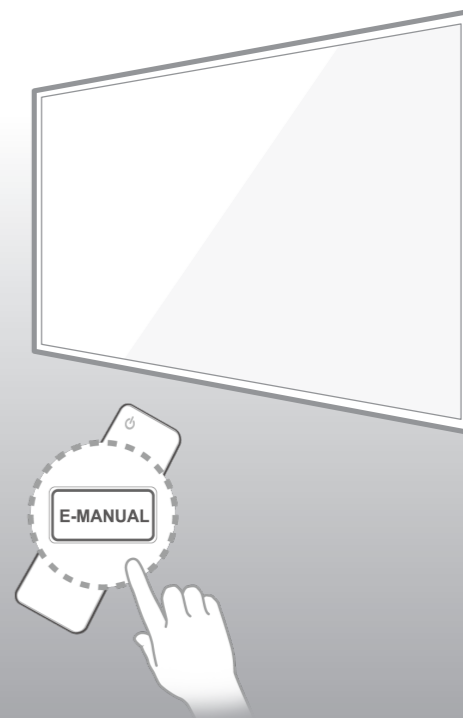

Thank you for purchasing this Samsung product.
To receive more complete service, please register
your product at
www.samsung.com/register

Model _____ Serial No. _____



Important Safety Instructions

SAMSUNG

Warning! Important Safety Instructions

(Please read the appropriate section that corresponds to the marking on your Samsung product before attempting to install the product.)

CAUTION

RISK OF ELECTRIC SHOCK DO NOT OPEN

CAUTION: TO REDUCE THE RISK OF ELECTRIC SHOCK, DO NOT REMOVE COVER (OR BACK). THERE ARE NO USER SERVICEABLE PARTS INSIDE. REFER ALL SERVICING TO QUALIFIED PERSONNEL.



This symbol indicates that high voltage is present inside. It is dangerous to make any kind of contact with any internal part of this product.



This symbol alerts you that important literature concerning operation and maintenance has been included with this product.

- The slots and openings in the cabinet and in the back or bottom are provided for necessary ventilation. To ensure reliable operation of this apparatus, and to protect it from overheating, these slots and openings must never be blocked or covered.
 - Do not cover this apparatus in a confined space, such as a bookcase, or built-in cabinet, unless proper ventilation is provided.
 - Do not place this apparatus near or over a radiator or heat resistor, or where it is exposed to direct sunlight.
 - Do not place a water containing vessel(vases etc.) on this apparatus, as this can result in a risk of fire or electric shock.
- Do not expose this apparatus to rain or place it near water(near a bathtub, washbowl, kitchen sink, or laundry tub, in a wet basement, or near a swimming pool etc.). If this apparatus accidentally gets wet, unplug it and contact an authorized dealer immediately. Make sure to pull out the power cord from the outlet before cleaning.
- This apparatus use batteries. In your community there might be regulations that require you to dispose of these batteries properly under environmental considerations. Please contact your local authorities for disposal or recycling information.
- Do not overload wall outlets, extension cords or adaptors beyond their capacity, since this can result in fire or electric shock.
- Power-supply cords should be routed so that they are not likely to be walked on or pinched by items placed upon or against them, paying particular attention to cords at plug end, adaptors and the point where they exit from the appliance.
- To protect this apparatus from a lightning storm, or when it is left unattended and unused for long periods of time, unplug it from the wall outlet and disconnect the antenna or cable system. This will prevent damage to the set due to lightning and power line surges.
- Before connecting the AC power cord to the DC adaptor outlet, make sure the voltage designation of the DC adaptor corresponds to the local electrical supply.
- Never insert anything metallic into the open parts of this apparatus. Doing so may create a danger of electric shock.
- To avoid electric shock, never touch the inside of this apparatus. Only a qualified technician should open this apparatus.
- Make sure to plug the power cord in until it is firmly inserted. When removing the power cord, make sure to hold the power plug when pulling the plug from the outlet. Do not touch the power cord with wet hands.
- If this apparatus does not operate normally - in particular, if there are any unusual sounds or smells coming from it - unplug it immediately and contact an authorized dealer or service centre.
- Be sure to pull the power plug out of the outlet if the TV is to remain unused or if you are to leave the house for an extended period of time (especially when children, elderly or disabled people will be left alone in the house).
 - Accumulated dust can cause an electric shock, an electric leakage or a fire by causing the power cord to generate sparks and heat or the insulation to deteriorate.
- Be sure to contact an authorized service centre, when installing your set in a location with heavy dust, high or low temperatures, high humidity, chemical substances and where it operates for 24 hours such as the aerial port, the train station etc.
- Failure to do so may cause serious damage to your set.
- Use only a properly grounded plug and receptacle.
- An improper ground may cause electric shock or equipment damage. (Class I Equipment only.)
- To disconnect the apparatus from the mains, the plug must be pulled out from the mains socket, therefore the mains plug shall be readily operable.
- Do not allow children to hang onto the product.
- Store the accessories (battery, etc.) in a location safely out of the reach of children.
- Do not install the product in an unstable location such as a shaky self, a slanted floor or a location exposed to vibration.
- Do not drop or impart any shock to the product. If the product is damaged, disconnect the power cord and contact a service centre.
- Unplug the power cord from the power outlet and wipe the product using a soft, dry cloth. Do not use any chemicals such as wax, benzene, alcohol, thinners, insecticide, aerial freshener, lubricant or detergent. This may damage the appearance or erase the printing on the product.
- Apparatus shall not be exposed to dripping or splashing.
- Do not dispose of batteries in a fire.
- Do not short circuit, disassemble or overheat the batteries.
- Danger of explosion if battery is incorrectly replaced. Replace only with the same or equivalent type.



**WARNING -
TO PREVENT THE SPREAD OF FIRE, KEEP CANDLES OR OTHER OPEN FLAMES
AWAY FROM THIS PRODUCT AT ALL TIMES.W**

English - 2

Figures and illustrations in this User Manual are provided for reference only and may differ from actual product appearance. Product design and specifications may be changed without notice.

CIS languages (Russian, Ukrainian, Kazakhs) are not available for this product, since this is manufactured for customers in EU region.

Important Warranty Information Regarding Television Format Viewing

1. Functionalities related to Digital TV (DVB) are only available in countries/areas where DVB-T (MPEG2 and MPEG4 AVC) digital terrestrial signals are broadcasted or where you are able to access to a compatible DVB-C (MPEG2 and MPEG4 AAC) cable-TV service. Please check with your local dealer the possibility to receive DVB-T or DVB-C signal.
2. DVB-T is the DVB European consortium standard for the broadcast transmission of digital terrestrial television and DVB-C is that for the broadcast transmission of digital TV over cable. However, some differentiated features like EPG (Electric Programme Guide), VOD (Video On Demand) and so on, are not included in this specification. So, they cannot be workable at this moment.
3. Although this TV set meets the latest DVB-T and DVB-C standards, as of [August, 2008], the compatibility with future DVB-T digital terrestrial and DVB-C digital cable broadcasts cannot be guaranteed.
4. Depending on the countries/areas where this TV set is used some cable-TV providers may charge an additional fee for such a service and you may be required to agree to terms and conditions of their business.
5. Some Digital TV functions might be unavailable in some countries or regions and DVB-C might not work correctly with some cable service providers.
6. For more information, please contact your local Samsung customer care centre.
 -  The reception quality of TV may be affected due to differences in broadcasting method between the countries. Please check the TV performance in the local SAMSUNG Authorized Dealer, or the Samsung Call Centre whether it can be improved by reconfiguring TV setting or not.

Correct Disposal of This Product (Waste Electrical & Electronic Equipment)

(Applicable in the European Union and other European countries with separate collection systems)



This marking on the product, accessories or literature indicates that the product and its electronic accessories (e.g. charger, headset, USB cable) should not be disposed of with other household waste at the end of their working life. To prevent possible harm to the environment or human health from uncontrolled waste disposal, please separate these items from other types of waste and recycle them responsibly to promote the sustainable reuse of material resources. Household users should contact either the retailer where they purchased this product, or their local government office, for details of where and how they can take these items for environmentally safe recycling. Business users should contact their supplier and check the terms and conditions of the purchase contract. This product and its electronic accessories should not be mixed with other commercial wastes for disposal.

Correct disposal of batteries in this product

(Applicable in the European Union and other European countries with separate battery return systems)



This marking on the battery, manual or packaging indicates that the batteries in this product should not be disposed of with other household waste at the end of their working life. Where marked, the chemical symbols Hg, Cd or Pb indicate that the battery contains mercury, cadmium or lead above the reference levels in EC Directive 2006/66. If batteries are not properly disposed of, these substances can cause harm to human health or the environment. To protect natural resources and to promote material reuse, please separate batteries from other types of waste and recycle them through your local, free battery return system.

User Instructions

- **Screen Image retention**

Do not display a still image (such as on a video game) on the plasma display panel for more than several minutes as it can cause screen image retention. This image retention is also known as “screen burn”. To avoid such image retention, reduce the degree of brightness and contrast of the screen when displaying a still image.

- **Heat on the top of the Plasma TV**

The top side of the product may be hot after long periods of use as heat dissipates from the panel through the vent hole in the upper part of the product.

This is normal and does not indicate any defect or operation failure of the product.

However, children should be prevented from touching the upper part of the product.

- **The product is making a “cracking” noise.**

A “cracking” noise may occur when the product contracts or expands due to a change in the surrounding environment such as temperature or humidity. This is normal and not a defect of the unit.

- **Cell Defects**

The PDP uses a panel consisting of 2,360,000(HD-level) to 6,221,000(FHD-level) pixels which require sophisticated technology to produce. However, there may be a few bright or dark pixels on the screen. These pixels will have no impact on the performance of the product.

- **Avoid operating the TV at temperatures below 41°F (5°C)**

- **A still image displayed too long may cause permanent damage to the PDP Panel.**



Watching the Plasma TV in 4:3 format for a long period of time may leave traces of borders displayed on the left, right and centre of the screen caused by the difference of light emission on the screen. Playing a DVD or a game console may cause similar effects to the screen.

Damages caused by the above effect are not covered by the Warranty.

- **After-images on the Screen.**

Displaying still images from Video games and PC for longer than a certain period of time may produce partial after-images.

To prevent this effect, reduce the “brightness” and “contrast” when displaying still images for a long time.

- **Warranty**

Warranty does not cover any damage caused by image retention.

Burn-in is not covered by the warranty.

- **Caution**



The glass screen of your PDP TV can break if you accidentally drop the TV. Handle the TV with care.

When moving the TV, always have two or more people pick it up and carry it as a safety precaution. Do not lay the TV flat on its face or back.

Your Samsung Plasma TV is a high quality television that has been carefully packaged to protect the integrity of its glass panel and component parts during shipment. It is, nonetheless, a fragile piece of electronics that requires careful handling. Refrain from putting undue stress on any part of the packaging when shipping or unpacking the TV. Use care when installing the TV. Avoid placing the TV in a location where it may be struck, exposed to sharp impacts, or fall. Panel breakage caused by a fall or impact strike is not covered under the manufacturer’s warranty.

Contents

What's in the Box?

- 6 List of Features
- 6 Accessories

Assembling the TV

- 7 Installing the Wall Mount
- 8 Storage and Maintenance
- 8 Securing the Installation Space
- 9 Securing the TV to the Wall
- 10 Anti-theft Kensington Lock
- 11 Connecting to a COMMON INTERFACE slot (Your TV viewing Card Slot)

Doing Initial setup

- 12 Initial Setup
- 12 Changing the Input Source
 - 12 Source

How to use the remote control

- 13 Viewing the Remote Control
 - 13 Installing batteries (Battery size: AAA)
- 14 Using the TV's Controller (Panel Key)
- 15 Teletext Feature

Getting more details from e-Manual

- 16 How to use the e-Manual

Troubleshooting and Maintenance

- 18 Troubleshooting

Specification and other information

- 22 Specifications
- 23 Supported Video Formats
- 25 Licence
- 26 Warranty Card
 - 27 Wiring the Mains Power Supply Plug (UK Only)

List of Features

- **Media Play:** Allows you to play music files, pictures, and movies saved on a USB device.
- **e-Manual:** Allows you to read on screen full manual. (p. 16)

Accessories

- ✎ Please make sure the following items are included with your TV. If any items are missing, contact your dealer.
- ✎ The items' colours and shapes may vary depending on the models.
- ✎ Cables not included in the package contents can be purchased separately.
- ✎ Check that there is no accessory hidden behind packing materials when you open the box.

- Remote Control & Batteries (AAA x 2)
- Regulatory Guide
- Power Cord
- Owner's Instructions



Cable Holder

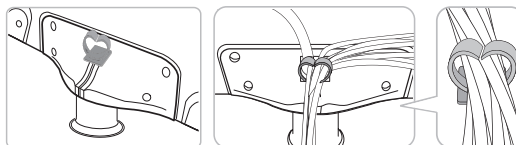

Arrange the cables using the Cable Holder



Ferrite Core (2EA)

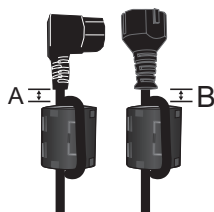

- ✎ **Ferrite Core for Power Cord:** The ferrite cores are used to shield the cables from interference. When connecting a cable, open the ferrite core and clip it around the cable near the plug as shown in the figure.

- **A** Maximum distance between the ferrite core and the end of the cord inserted in the TV: 3/4 inches (2cm)
- **B** Maximum distance between the ferrite core and the other end of the cord inserted in the AC outlet: 3/4 inches (2cm)

- ✎ An administration fee may be charged if either
 - (a) an engineer is called out at your request and there is no defect in the product (i.e. where you have failed to read this user manual)
 - (b) you bring the unit to a repair centre and there is no defect in the product (i.e. where you have failed to read this user manual)
- ✎ The amount of such administration charge will be advised to you before any work or home visit is carried out.

Installing the Wall Mount

The wall mount kit (sold separately) allows you to mount the TV on the wall. For detailed information on installing the wall mount, see the instructions provided with the wall mount. Contact a technician for assistance when installing the wall mount bracket. We do not advise you to do it yourself.

Samsung Electronics is not responsible for any damage to the product or injury to yourself or others if you select to install the TV on your own.

Wall Mount Kit Specifications (VESA)

- Wall mount kit is not supplied but sold separately.
- Install your wall mount on a solid wall perpendicular to the floor. When attaching to other building materials, please contact your nearest dealer. If installed on a ceiling or slanted wall, it may fall and result in severe personal injury.

NOTE

- Standard dimensions for wall mount kits are shown in the table below.
- When purchasing our wall mount kit, a detailed installation manual and all parts necessary for assembly are provided.
- Do not use screws that do not comply with the VESA standard screw specifications.
- Do not use screws longer than the standard dimension, as they may cause damage to the inside of the TV set.
- For wall mounts that do not comply with the VESA standard screw specifications, the length of the screws may differ depending on their specifications.
- Do not fasten the screws too strongly, this may damage the product or cause the product to fall, leading to personal injury. Samsung is not liable for these kinds of accidents.
- Samsung is not liable for product damage or personal injury when a non-VESA or non-specified wall mount is used or the consumer fails to follow the product installation instructions.
- Do not exceed 15 degrees tilt when mounting this TV.

inches	VESA Spec. (A * B)	Standard Screw	Quantity
43~51	400 X 400	M8	4

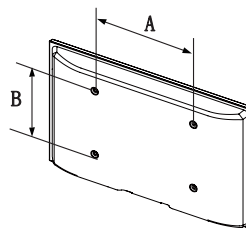

Storage and Maintenance

- ✎ If you remove the attached sticker on the TV screen, clean the residues and then watch TV.
- ✎ The exterior and screen of the product can get scratched during cleaning. Be sure to wipe the exterior and screen carefully using a soft cloth to prevent scratches.



Do not spray water directly onto the product. Any liquid that goes into the product may cause a failure, fire, or electric shock.

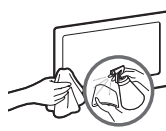

Clean the product with a soft cloth dipped in a small amount of water. Do not use a flammable liquid (e.g. benzene, thinners) or a cleaning agent.

Securing the Installation Space

Keep the required distances between the product and other objects (e.g. walls) to ensure proper ventilation.

Failing to do so may result in fire or a problem with the product due to an increase in the internal temperature of the product.

- ✎ When using a stand or wall-mount, use parts provided by Samsung Electronics only.
 - If you use parts provided by another manufacturer, it may result in a problem with the product or an injury due to the product falling.
- ✎ The appearance may differ depending on the product.
- ✎ Be careful when you contact the TV because some parts can be somewhat hot.

Installation with a stand.

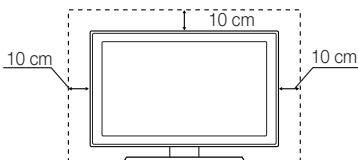

Installation with a wall-mount.

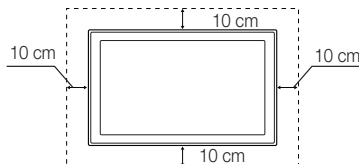

Securing the TV to the Wall



Caution: Pulling, pushing, or climbing on the TV may cause the TV to fall. In particular, ensure your children do not hang on or destabilize the TV. Doing so may cause the TV to tip over, causing serious injuries or death. Follow all safety precautions provided in the Safety Flyer included with your TV. For added stability and safety, you can purchase and install the anti-fall device as described below.

To avoid the TV from falling

1. Put the screws into the clamps and firmly fasten them onto the wall. Confirm that the screws have been firmly installed onto the wall.
 - You may need additional material such as an anchor depending on the type of wall.
 - Since the necessary clamps, screws, and string are not supplied, please purchase these additionally.
2. Remove the screws from the centre back of the TV, put the screws into the clamps, and then fasten the screws onto the TV again.

Screw Specifications

- For a 43~51 inches: M8

3. Connect the clamps fixed onto the TV and the clamps fixed onto the wall with a strong string and then tie the string tightly.

NOTE

- Install the TV near to the wall so that it does not fall backwards.
- It is safe to connect the string so that the clamps fixed on the wall are equal to or lower than the clamps fixed on the TV.
- Untie the string before moving the TV.

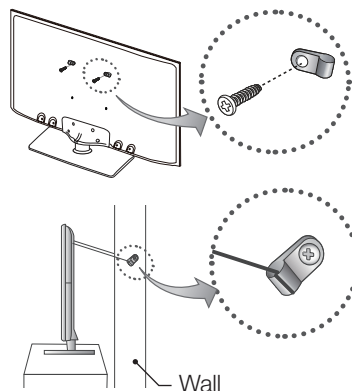

4. Verify all connections are properly secured. Periodically check connections for any sign of fatigue for failure. If you have any doubt about the security of your connections, contact a professional installer.



- The product colour and shape may vary depending on the model.

Anti-theft Kensington Lock

The Kensington Lock is not supplied by Samsung. It is a device used to physically fix the system when using it in a public place. The appearance and locking method may differ from the illustration depending on the manufacturer. Refer to the manual provided with the Kensington Lock for additional information on proper use.

- ✎ Please find a “” icon on the rear of the TV. A Kensington slot is beside the “” icon.
- ✎ The position and colour may differ depending on the model.

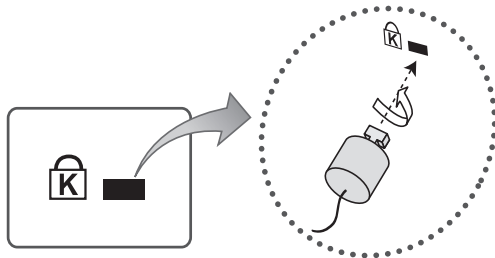

<Optional>

To lock the product, follow these steps:

1. Wrap the Kensington lock cable around a large, stationary object such as desk or chair.
2. Slide the end of the cable with the lock attached through the looped end of the Kensington lock cable.
3. Insert the locking device into the Kensington slot on the product.
4. Lock the lock.

- ✎ These are general instructions. For exact instructions, see the User manual supplied with the locking device.
- ✎ The locking device has to be purchased separately.

Connecting to a COMMON INTERFACE slot (Your TV viewing Card Slot)

Turn the TV off to connect or disconnect a CI card.

Using the “CI or CI+ CARD”

To watch paid channels, the “CI or CI+ CARD” must be inserted.

- If you don't insert the “CI or CI+ CARD”, some channels will display the message “Scrambled Signal”.
- The pairing information containing a telephone number, the “CI or CI+ CARD” ID the Host ID and other information will be displayed in about 2~3 minutes. If an error message is displayed, please contact your service provider.
- When the configuration of channel information has finished, the message “Updating Completed” is displayed, indicating the channel list is updated.

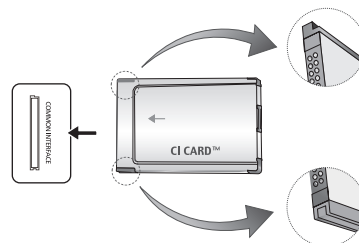

- The image may differ depending on the model.

NOTE

- You must obtain a “CI or CI+ CARD” from a local cable service provider.
- When removing the “CI or CI+ CARD”, carefully pull it out with your hands since dropping the “CI or CI+ CARD” may cause damage to it.
- Insert the “CI or CI+ CARD” in the direction marked on the card.
- The location of the COMMON INTERFACE slot may be different depending on the model.
- “CI or CI+ CARD” is not supported in some countries and regions; check with your authorized dealer.
- If you have any problems, please contact a service provider.
- Insert the “CI or CI+ CARD” that supports the current aerial settings. The screen will be distorted or will not be seen.

Initial Setup

When the TV is initially powered on, a sequence of on-screen prompts will assist in configuring basic settings. Press the **POWER** button. **Setup** is available only when the source is set to TV.

- ✎ If you connect any device to **HDMI IN 1(STB)** before starting the installation, **Channel Source** will be changed to **Set-top box** automatically. If you do not want to select **Set-top box**, please select **Aerial**.

If You Want to Reset This Feature...

Select **System - Setup** (Initial Setup). Enter your 4 digit PIN number. The default password is "0-0-0-0". If you want to change the PIN number, use the **Change PIN** function.

You should do **Setup (MENU → System)** again at home even though you did in shop already.

- ✎ If you forget the PIN code, press the remote control buttons in the following sequence in Standby mode, which resets the PIN to "0-0-0-0": **MUTE → 8 → 2 → 4 → POWER (on)**

Changing the Input Source

Source

TV / Ext. / HDMI1 / HDMI2/DVI / AV / Component

Use to select TV or other external input sources such as DVD / Blu-ray players / cable box / STB satellite receiver connected to the TV.

- ✎ Press the **SOURCE** button. In the displayed **Source** list, connected inputs will be highlighted.
- ✎ PC(D-Sub) input is not supported. If you want to connect PC to the TV, you can connect the HDMI to DVI cable with the **HDMI IN 2(DVI)** port on the TV.
- ✎ **Ext.** always stays activated.
- ✎ Press the **TOOLS** button.

- **Edit Name**

You can set an external input source name you want.

- When connecting a PC to the **HDMI IN 2(DVI)** port with HDMI cable, you should set the TV to **PC** mode under **Edit Name**.
- When connecting a PC to the **HDMI IN 2(DVI)** port with HDMI to DVI cable, you should set the TV to **DVI PC** mode under **Edit Name**.
- When connecting an AV devices to the **HDMI IN 2(DVI)** port with HDMI to DVI cable, you should set the TV to **DVI Devices** mode under **Edit Name**.

- **Information**

You can see detailed information about the connected external device.

Viewing the Remote Control

This is a special remote control for the visually impaired persons and has Braille points on the **Power**, **Channel**, and **Volume** buttons.

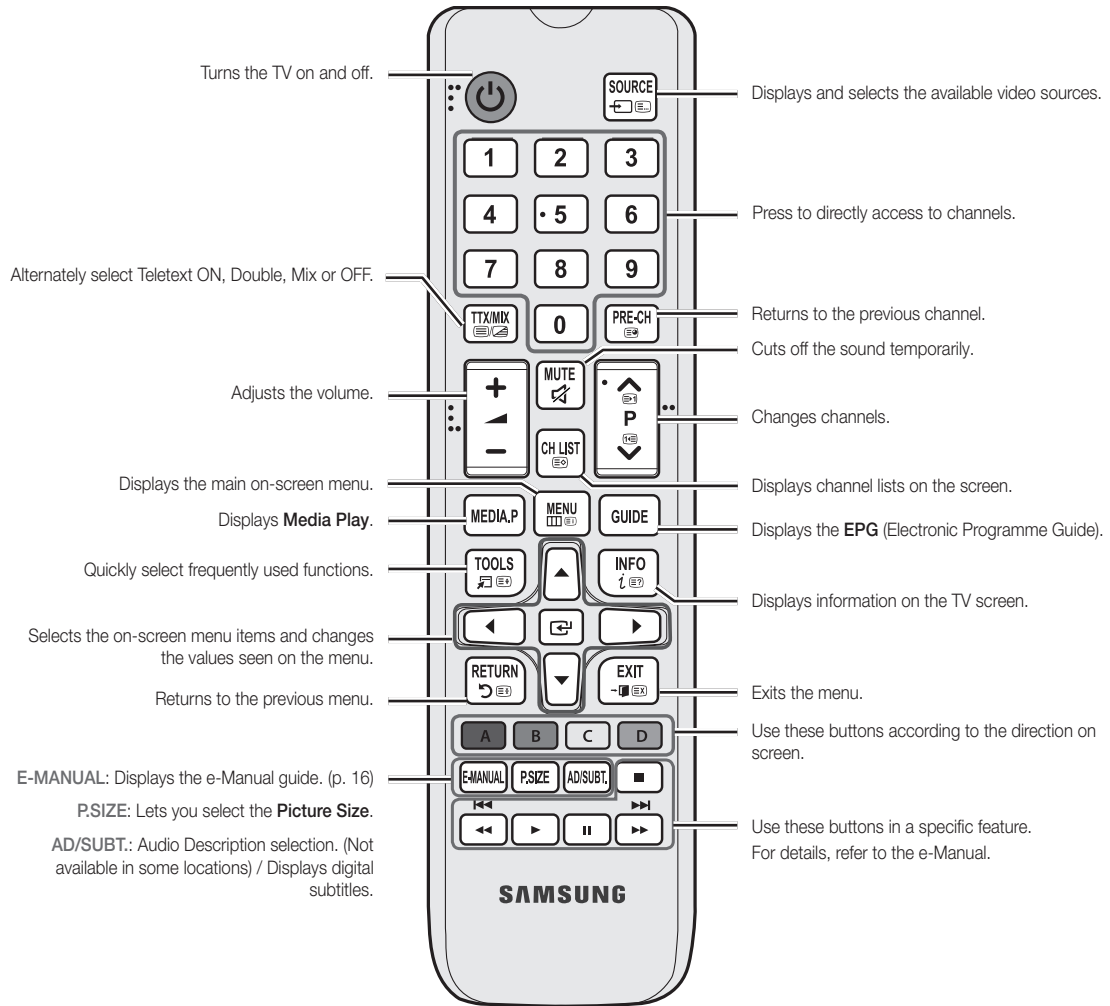

Installing batteries (Battery size: AAA)

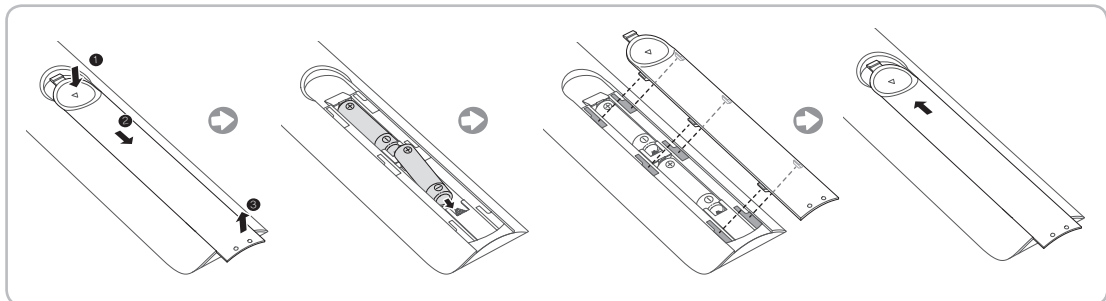

Using the TV's Controller (Panel Key)

The TV's Controller, a small joystick like button on the rear right side of the TV, lets you control the TV without the remote control.

- Some functions which require a PIN code may not be available.
- The product colour and shape may vary depending on the model.
- Exits the menu when pressing the controller more than 1 second.
- When using the controller in the up/down/left/right directions, make sure you do not push the controller in first. If you push the controller in first it will not move in the up/down/left right directions.

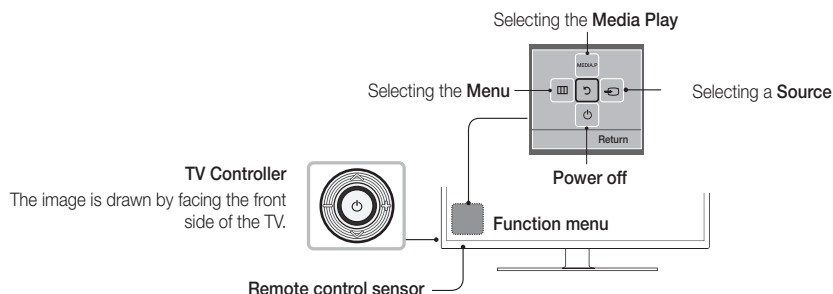

Standby mode

Do not leave your TV in standby mode for long periods of time (when you are away on a holiday, for example). A small amount of electric power is still consumed even when the power button is turned off. It is best to unplug the power cord.

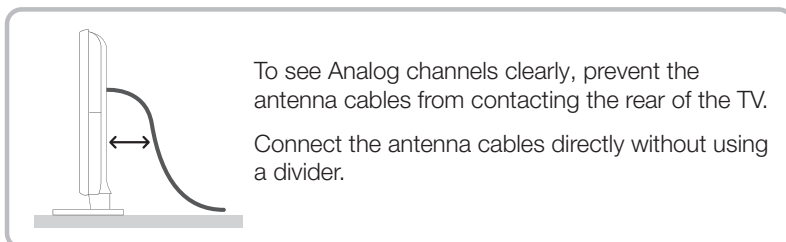

- The PDP device may interfere with an amateur radio or AM radio.
- When using two-way radio mobile and portable units or amateur radio or AM radio near by your TV, this may cause the TV to malfunction.

Teletext Feature

The index page of the Teletext service gives you information on how to use the service. For Teletext information to be displayed correctly, channel reception must be stable. Otherwise, information may be missing or some pages may not be displayed.

You can change Teletext pages by pressing the numeric buttons on the remote control.

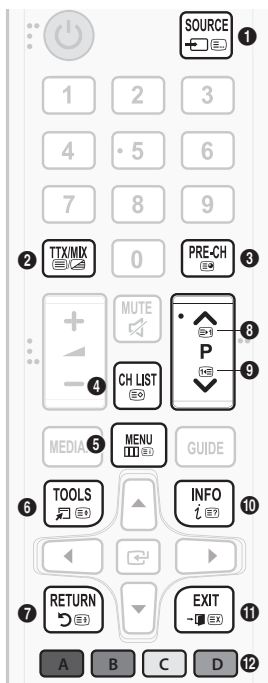

- 1 (mode): Selects the Teletext mode (LIST/FLOF). If pressed during LIST mode, switches the mode to List save mode. In List save mode, you can save a Teletext page into a list using the (store) button.
- 2 (Full TTX/Double TTX/mix/off): Activates the Teletext mode for the current channel. Press the button twice to overlap the Teletext mode with the current broadcasting screen. Press it one more time to exit teletext.
- 3 (sub-page): Displays the available sub-page.
- 4 (store): Stores the Teletext pages.
- 5 (index): Displays the index (contents) page at any time while you are viewing Teletext.
- 6 (size): Displays the teletext on the upper half of the screen in double-size. To move the text to the lower half of the screen, press it again. For normal display, press it once again.
- 7 (hold): Holds the display at the current page, in the case that there are several secondary pages that follow automatically. To undo, press it again.
- 8 (page up): Displays the next Teletext page.
- 9 (page down): Displays the previous Teletext page.
- 10 (reveal): Displays the hidden text (answers to quiz games, for example). To display the normal screen, press it again.
- 11 (cancel): Shrinks the Teletext display to overlap with the current broadcast.
- 12 Colour buttons (red, green, yellow, blue): If the FASTEXT system is used by the broadcasting company, the different topics on a Teletext page are colour-coded and can be selected by pressing the coloured buttons. Press the colour corresponding to the topic of your choice. A new colour coded page is displayed. Items can be selected in the same way. To display the previous or next page, press the corresponding coloured button.

The Teletext pages are organized according to six categories

Part	Contents
A	Selected page number.
B	Broadcasting channel identity.
C	Current page number or search indications.
D	Date and time.
E	Text.
F	Status information. FASTEXT information.

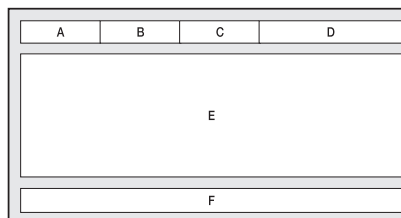

How to use the e-Manual



You can find instructions about your TV's features in the **e-Manual** in your TV. To use, press the **E-MANUAL** button on your remote. Move the cursor using the up/down/right/left buttons to highlight a category, then a topic, and then press the **ENTER** button. The **e-Manual** displays the page you want to see.

You can also access it through the menu:

MENU → **Support** → **e-Manual** → **ENTER**

To return to the **e-Manual** main menu, press the **E-MANUAL** button on the remote.

Screen Display

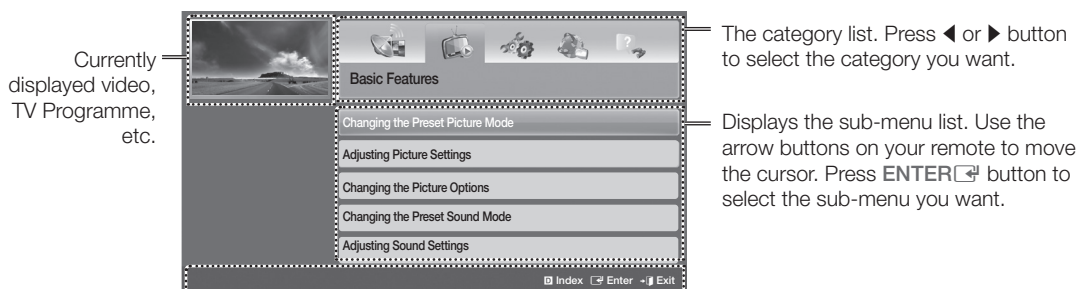

Operation Buttons

- Index**: Displays the index screen.
- Enter**: Selects a category or sub-menu.
- Exit**: Exit the e-Manual.

<Viewing the Contents>

- Try now**: Displays the OSD menu that corresponds to the topic. To return to the e-Manual screen, press the **E-MANUAL** button.
- Home**: Moves to the e-Manual home screen.
- Page**: Moves to previous or next page.
- Zoom**: Magnifies a screen.
 - Press the **Zoom** button to magnify the screen. You can scroll through the magnified screen by using the u or d buttons. To return to the screen to normal size, press the **RETURN** button.

How to toggle between an e-Manual topic and the corresponding OSD menu(s).

- This function is not enabled in some menus.
- You cannot use the **Try now** function if the menu is not activated.

Method 1	Method 2
<ol style="list-style-type: none"> 1. If you want to use the menu that corresponds to an e-Manual topic, press the red button to select Try now. 2. To return to the e-Manual screen, press the E-MANUAL button. 	<ol style="list-style-type: none"> 1. Press the ENTER button when a topic is displayed. "Are you sure?" appears. Select Yes, and then press the ENTER button. The OSD window appears. 2. To return to the e-Manual screen, press the E-MANUAL button.

How to search for a topic on the index page

 This function may not be supported depending on the language.

1. If you want to search a keyword, press the blue button to select **Index**.
2. Press the ◀ or ▶ button to select a character order you want.
3. Press the ▲ or ▼ button to select a keyword you want to see, and then press the **ENTER** button.
4. You can view the corresponding e-Manual instruction screen.
 -  To close the **Index** screen, press the **RETURN** button.

Troubleshooting

If the TV seems to have a problem, first try this list of possible problems and solutions. If none of these troubleshooting tips apply, visit “www.samsung.com”, then click on Support, or call Samsung customer service centre.

Issues	Solutions and Explanations
Picture Quality	First of all, please perform the Picture Test and confirm that your TV is properly displaying test image. (go to MENU - Support - Self Diagnosis - Picture Test) If the test image is properly displayed, the poor picture may caused by the source or signal.
The TV image does not look as good as it did in the store.	<ul style="list-style-type: none"> • If you have an analogue cable/set top box, upgrade to a digital set top box. Use HDMI or Component cables to deliver HD (high definition) picture quality. • Cable/Satellite subscribers: Try HD stations from the channel line up. • Aerial connection: Try HD stations after performing Auto tuning. • Many HD channels are up scaled from SD (Standard Definition) contents. • Adjust the Cable/Set top box video output resolution to 1080i or 720p. • Make sure you are watching the TV at the minimum recommended distance based on the size and definition of the signal.
The picture is distorted: macroblock error, small block, dots, pixelization	<ul style="list-style-type: none"> • Compression of video contents may cause picture distortion especially in fast moving pictures such as sports and action movies. • Low signal level or bad quality can cause picture distortion. This is not a TV issue. • Mobile phones used close to the TV (cca up to 1m) may cause noise in picture on analogue and digital TV.
Colour is wrong or missing.	<ul style="list-style-type: none"> • If you're using a component connection, make sure the component cables are connected to the correct jacks. Incorrect or loose connections may cause colour problems or a blank screen.
There is poor colour or brightness.	<ul style="list-style-type: none"> • Adjust the Picture options in the TV menu. (go to Picture Mode / Colour / Brightness / Sharpness) • Adjust Energy Saving option in the TV menu. (go to MENU - System - Eco Solution - Energy Saving) • Try resetting the picture to view the default picture settings. (go to MENU - Picture - Reset Picture)
There is a dotted line on the edge of the screen.	<ul style="list-style-type: none"> • If the picture size is set to Screen Fit, change it to 16:9. • Change cable/satellite box resolution.
The picture is black and white.	<ul style="list-style-type: none"> • If you are using an AV composite input, connect the video cable (yellow) to the Green jack of component input 1 on the TV.
When changing channels, the picture freezes or is distorted or delayed.	<ul style="list-style-type: none"> • If connected with a cable box, please try to reset the cable box. Reconnect the AC cord and wait until the cable box reboots. It may take up to 20 minutes. • Set the output resolution of the cable box to 1080i or 720p.

Issues	Solutions and Explanations
Sound Quality	<p>First of all, please perform the Sound Test to confirm that your TV audio is properly operating. (go to MENU - Support - Self Diagnosis - Sound Test)</p> <p>If the audio is ok, the sound problem may be caused by the source or signal.</p>
There is no sound or the sound is too low at maximum volume.	<ul style="list-style-type: none"> • Please check the volume of the device (Cable/Sat Box, DVD, Blu-ray etc) connected to your TV.
The picture is good but there is no sound.	<ul style="list-style-type: none"> • Set the Speaker Select option to TV Speaker in the sound menu. • If you are using an external device, make sure the audio cables are connected to the correct audio input jacks on the TV. • If you are using an external device, check the device's audio output option (ex. you may need to change your cable box's audio option to HDMI when you have a HDMI connected to your TV). • Reboot the connected device by reconnecting the device's power cable.
The speakers are making an inappropriate noise.	<ul style="list-style-type: none"> • Check the cable connections. Make sure a video cable is not connected to an audio input. • For aerial or cable connections, check the signal strength. Low signal level may cause sound distortion.
No Picture, No Video	
The TV will not turn on.	<ul style="list-style-type: none"> • Make sure the AC power cord is securely plugged in to the wall outlet and the TV. • Make sure the wall outlet is working. • Try pressing the POWER button on the TV to make sure the problem is not the remote. If the TV turns on, refer to "The remote control does not work" below.
The TV turns off automatically.	<ul style="list-style-type: none"> • Ensure the Sleep Timer is set to Off in the Time menu. • If your PC is connected to the TV, check your PC power settings. • Make sure the AC power cord is plugged in securely to the wall outlet and the TV. • When watching TV from an aerial or cable connection, the TV will turn off after 10 ~ 15 minutes if there is no signal.
There is no picture/video.	<ul style="list-style-type: none"> • Check cable connections (remove and reconnect all cables connected to the TV and external devices). • Set your external device's (Cable/Set top Box, DVD, Blu-ray etc) video outputs to match the connections to the TV input. For example, if an external device's output is HDMI, it should be connected to an HDMI input on the TV. • Make sure your connected devices are powered on. • Be sure to select the TV's correct source by pressing the SOURCE button on the remote control. • Reboot the connected device by reconnecting the device's power cable.

Issues	Solutions and Explanations
Aerial (Air/Cable) Connection	
The TV is not receiving all channels.	<ul style="list-style-type: none"> • Make sure the Aerial cable is connected securely. • Please try Setup (Initial setup) to add available channels to the channel list. Go to MENU - System - Setup (Initial setup) and wait for all available channels to be stored. • Verify the Aerial is positioned correctly.
The picture is distorted: macro block error small block, dots, pixelization	<ul style="list-style-type: none"> • Compression of video contents may cause picture distortion, especially on fast moving pictures such as sports and action movies. • A low signal can cause picture distortion. This is not a TV issue.
Others	
The picture will not display in full screen.	<ul style="list-style-type: none"> • HD channels will have black bars on either side of the screen when displaying up scaled SD (4:3) contents. • Black bars on the top and bottom will appear during movies that have aspect ratios different from your TV. • Adjust the picture size options on your external device or TV to full screen.
Plasma TV is making humming noise.	<ul style="list-style-type: none"> • Plasma TVs typically make a soft humming sound. This is normal. It's caused by the electrical charges that are used to create the images on the screen. • If the humming sound is loud, you may have set the brightness on the TV too high. Try setting the brightness lower. • You can also have loud humming if the back of your Plasma TV is too close to a wall or other hard surface. Also try rerouting your connection cables. • Improper installation of wall mount can create excessive noise.
Image Retention (Burn In) Issue.	<ul style="list-style-type: none"> • To minimize the possibility of screen burn, this unit is equipped with Pixel Shift screen burn reduction technology. Pixel Shift lets you set the picture so it moves slightly up and down (Vertical Line) and side to side (Horizontal Dot). The regular, slight movement of the picture reduces screen burn in.
The remote control does not work.	<ul style="list-style-type: none"> • Replace the remote control batteries with the poles (+/-) in the right direction. • Clean the sensor's transmission window on the remote. • Try pointing the remote directly at the TV from 5~6 feet away.
The cable/set top box remote control doesn't turn the TV on or off, or adjust the volume.	<ul style="list-style-type: none"> • Programme the Cable/Set top box remote control to operate the TV. Refer to the Cable/Set top box user manual for the SAMSUNG TV code.
A " Mode Not Supported " message appears.	<ul style="list-style-type: none"> • Check the supported resolution of the TV, and adjust the external device's output resolution accordingly.
There is a plastic smell from the TV.	<ul style="list-style-type: none"> • This smell is normal and will dissipate over time.

Issues	Solutions and Explanations
The TV Signal Information is unavailable in the Self Diagnosis Test menu.	<ul style="list-style-type: none"> This function is only available with digital channels from an Aerial / RF / Coax connection.
TV is tilted to the right or left side.	<ul style="list-style-type: none"> Remove the stand base from the TV and reassemble it.
There are difficulties assembling the stand base.	<ul style="list-style-type: none"> Make sure the TV is placed on a flat surface. If you can not remove the screws from the TV, please use a magnetized screw driver.
The Broadcasting menu is grey out (unavailable).	<ul style="list-style-type: none"> The Broadcasting menu is only available when the TV source is selected.
Your settings are lost after 30 minutes or every time the TV is turned off.	<ul style="list-style-type: none"> If the TV is in the Store Demo mode, it will reset audio and picture settings every 30 minutes. If you want to change the settings from Store Demo mode to Home Use, press the SOURCE button to select TV mode, and go to MENU → Support → Use Mode.
You have intermittent loss of audio or video.	<ul style="list-style-type: none"> Check the cable connections and reconnect them. Loss of audio or video can be caused by using overly rigid or thick cables. Make sure the cables are flexible enough for long term use. If mounting the TV to the wall, we recommend using cables with 90 degree connectors.
You see small particles when you look closely at the edge of the frame of the TV.	<ul style="list-style-type: none"> This is part of the product's design and is not a defect.
The PIP menu is not available.	<ul style="list-style-type: none"> PIP functionality is only available when you are using a HDMI or components source.
You turned the TV off 45 minutes ago, and it turned on again.	<ul style="list-style-type: none"> It is normal. The TV operates the OTA (Over The Aerial) function itself to upgrade firmware downloaded whilst your watching TV.
The message " Scrambled Signal " or " Weak or No Signal " appears.	<ul style="list-style-type: none"> If you are using a CAM CARD (CI/CI+), check that it is installed into the common interface slot. If there is still a problem, pull the CAM CARD out of the TV and insert it into the slot again.
There are recurrent picture/sound issues.	<ul style="list-style-type: none"> Check and change the signal/source.
A reaction may occur between the rubber cushion pads on the base stand and the top finish of some furniture.	<ul style="list-style-type: none"> To prevent this, use felt pads on any surface of the TV that comes in direct contact with furniture.
The message " This file may not be playable properly. " appears.	<ul style="list-style-type: none"> This may appear because of high bit rate of content. Content generally will play but could experience some playability issue.

🔧 You can keep your TV in optimum operating condition by upgrading to the latest firmware (www.samsung.com → support) by USB.

Specifications

Environmental Considerations		
Operating Temperature	10°C to 40°C (50°F to 104°F)	
Operating Humidity	10% to 80%, non-condensing	
Storage Temperature	-20°C to 45°C (-4°F to 113°F)	
Storage Humidity	5% to 95%, non-condensing	
Display Resolution	1024 X 768	
Sound (Output)	10 W X 2	
Model Name	PE43H4500	PE51H4500
Screen Size	43 inches	51 inches
Dimensions (W x H x D)		
Body	1009.7 x 617.5 x 55.7 mm	1185.2 x 702.1 x 55.7 mm
With stand	1009.7 x 698.8 x 235.0 mm	1185.2 x 783.0 x 235.0 mm
Weight		
Without Stand	13.60 kg	17.70 kg
With Stand	15.00 kg	19.10 kg

- Design and specifications are subject to change without prior notice.
- For information about power supply, and more about power consumption, refer to the label attached to the product.
- Typical power consumption is measured according to IEC 62087 Ed.2

Recommendation - EU Only



- Hereby, Samsung Electronics, declares that this PDP TV is in compliance with the essential requirements and other relevant provisions of Directive 1999/5/EC.
- This equipment may be operated in all EU countries.
- The official Declaration of Conformity may be found at <http://www.samsung.com>, go to Support > Search Product Support and enter the model name.

Supported Video Formats

File Extension	Container	Video Codec	Resolution	Frame rate (fps)	Bit rate (Mbps)	Audio Codec
*.avi / *.mkv *.asf / *.wmv *.mp4 / *.3gp *.vro / *.mpg *.mpeg / *.ts *.tp / *.trp *.mov / *.flv *.vob / *.svi *.divx	AVI	DivX 3.11/4.x/5.x/6.x	1920 x 1080	6-30	30	AC3
	MKV	MPEG4 SP/ASP				LPCM
	ASF	H.264 BP/MP/HP	640 x 480		ADPCM (IMA, MS)	
	MP4	Motion JPEG			8	AAC
	3GP	Window Media Video v9	1920 x 1080		30	HE-AAC
	MOV	MPEG2				WMA
	FLV	MPEG1				DD+
	VRO					MPEG (MP3)
	VOB					DTS (Core)
	PS					G.711(A-Law, μ -Law)
TS						

Other Restrictions

- Video content will not play, or not play correctly, if there is an error in the content or the container.
- Sound or video may not work if the contents have a standard bit rate/frame rate above the compatible Frame/sec listed in the table.
- If the Index Table is in error, the Seek (Jump) function is not supported.
- Some USB/digital camera devices may not be compatible with the player.
- The menu can be displayed late if the video is over 10Mbps(bit rate).

Video decoder	Audio decoder
<ul style="list-style-type: none"> • Supports up to H.264, Level 4.1 (FMO/ASO/RS are not supported.) • frame rate : <ul style="list-style-type: none"> - Below 1280 x 720: 60 frame max - Above 1280 x 720: 30 frame max • VC1 AP L4 is not supported. • GMC 2 or higher is not supported. 	<ul style="list-style-type: none"> • WMA 10 Pro supports up to 5.1 channel and M2 profile. • WMA lossless audio is not supported. • Vorbis supports up to 2ch. • DD+ supports up to 5.1 channel.

Supported Subtitle Formats

External

Name	File extension
MPEG-4 timed text	.txt
SAMI	.smi
SubRip	.srt
SubViewer	.sub
Micro DVD	.sub or .txt
SubStation Alpha	.ssa
Advanced SubStation Alpha	.ass
Powerdivx	.psb

Internal

Name	Container	Format
Xsub	AVI	Picture Format
SubStation Alpha	MKV	Text Format
Advanced SubStation Alpha	MKV	Text Format
SubRip	MKV	Text Format
MPEG-4 Timed text	MP4	Text Format

Supported Photo Formats

File Extension	Type	Resolution
*.jpg *.jpeg	JPEG	15360 X 8640
*.bmp	BMP	4096 X 4096
*.mpo	MPO	15360 X 8640

- The MPO type file does not support Zoom, Rotate and Slide Show Effect functions.

Supported Music Formats

File Extension	Type	Codec	Remark
*.mp3	MPEG	MPEG1 Audio Layer 3	
*.m4a *.mpa *.aac	MPEG4	AAC	
*.flac	FLAC	FLAC	Supports up to 2ch.
*.ogg	OGG	Vorbis	Supports up to 2ch.
*.wma	WMA	WMA	WMA 10 Pro supports up to 5.1 channel and M2 profile. (WMA lossless audio is not supported.)
*.wav	wav	wav	
*.mid *.midi	midi	midi	type 0 and type 1

Full available resolution: 1024 X 768 @ 60 Hz

Optimal resolution is 1024 X 768 @ 60 Hz. See specification page for full available resolution.

Mode	Resolution	Horizontal Frequency (KHz)	Vertical Frequency (Hz)	Pixel Clock Frequency (MHz)	Sync Polarity (H / V)
IBM	720 x 400	31.469	70.087	28.322	-/+
MAC	640 x 480	35.000	66.667	30.240	-/-
	832 x 624	49.726	74.551	57.284	-/-
VESA DMT	640 x 480	31.469	59.940	25.175	-/-
	640 x 480	37.861	72.809	31.500	-/-
	640 x 480	37.500	75.000	31.500	-/-
	800 x 600	37.879	60.317	40.000	+/+
	800 x 600	48.077	72.188	50.000	+/+
	800 x 600	46.875	75.000	49.500	+/+
	1024 x 768	48.363	60.004	65.000	-/-
	1024 x 768	56.476	70.069	75.000	-/-
	1024 x 768	60.023	75.029	78.750	+/+

NOTE

- The interlace mode is not supported.
- The set might operate abnormally if a non-standard video format is selected.

Licence



Manufactured under license from Dolby Laboratories. Dolby and the double-D symbol are trademarks of Dolby Laboratories.



Manufactured under a license from U.S. Patent No's: 5,956,674, 5,974,380, 5,978,762, 6,487,535, 6,226,616, 7,212,872, 7,003,467, 7,272,567, 7,668,723, 7,392,195, 7,930,184, 7,333,929 and 7,548,853. DTS, the Symbol, and DTS and the Symbol together are registered trademarks & DTS Premium Sound | 5.1 is a trademark of DTS, Inc. ©2012 DTS, Inc. All Rights Reserved.



Manufactured under a license from U.S. Patent No's: 6,285,767, 8,027,477, 5,319,713, 5,333,201, 5,638,452, 5,771,295, 5,970,152, 5,912,976, 7,200,236, 7,492,907, 8,050,434, 7,720,240, 7,031,474, 7,907,736 and 7,764,802. DTS, the Symbol, and DTS and the Symbol together are registered trademarks & DTS Studio Sound is a trademark of DTS, Inc. ©2012 DTS, Inc. All Rights Reserved.



The terms HDMI and HDMI High-Definition Multimedia Interface, and the HDMI Logo are trademarks or registered trademarks of HDMI Licensing LLC in the United States and other countries.



DivX Certified® to play DivX® video up to HD 1080p, including premium content.

ABOUT DIVX VIDEO: DivX® is a digital video format created by DivX, LLC, a subsidiary of Rovi Corporation. This is an official DivX Certified® device that has passed rigorous testing to verify that it plays DivX video. Visit divx.com for more information and software tools to convert your files into DivX videos.

ABOUT DIVX VIDEO-ON-DEMAND: This DivX Certified® device must be registered in order to play purchased DivX Video-on-Demand (VOD) movies. To obtain your registration code, locate the DivX VOD section in your device setup menu. Go to vod.divx.com for more information on how to complete your registration.

DivX®, DivX Certified® and associated logos are trademarks of Rovi Corporation or its subsidiaries and are used under license.

Covered by one or more of the following U.S. patents: 7,295,673; 7,460,668; 7,515,710; 7,519,274

Open source licence notice

In the case of using open source software, Open Source Licences are available on the product menu.

Open Source Licence Notice is written only English.

- WARNINGS:** Image retention, commonly known as screen burn-in, can occur on most types of television if the same image is displayed continuously. The most common causes of image retention are logos that remain stationary on the TV screen. These logos are common on many programmes received via a Set-top Box. To reduce this risk, avoid displaying still images for long durations and lower the brightness or contrast settings to decrease the intensity of the picture. Extended viewing of movies and programs in aspect ratios that are different from the aspect ratio of the TV may cause image retention. Always endeavour to avoid black borders top or bottom by using the zoom function. This will help eliminate the black borders and fit the picture to the entire area of the screen. Using a video game console may cause image retention and is not recommended. When using a PC input, avoid displaying still images for long durations and reduce the brightness or contrast settings to decrease the intensity of the picture.
- IMPORTANT:** Image retention issues are not covered by your Samsung® warranty.

Warranty Card



United Kingdom



Republic of Ireland (EIRE)

This Samsung product is warranted for a period of twelve (12) months from the original date of purchase, against defective materials and workmanship. In the event that warranty service is required, you should return the product to the retailer from whom it was purchased. However, Samsung Authorised Dealers and Authorised Service Centres in other EC Countries will comply with the warranty on the terms issued to purchasers in the country concerned. In case of difficulty, details of our Authorised Service Centres are available from:

Samsung Electronics U.K. Ltd.
Customer Care Centre
PO Box 479
GATESHEAD NE9 9BJ
United Kingdom
Tel: 0330 SAMSUNG (7267864) / Fax: 0330 7260001 (UK & Northern Ireland)
Tel: 0818 717100 / Fax: +44 117 915 6736 (EIRE Only)
Web: www.samsung.com

WARRANTY CONDITIONS

1. The warranty is only valid if, when warranty service is required, the warranty card is fully and properly completed and is presented with the original invoice or sales slip or confirmation, and the serial number on the product has not been defaced.
2. Samsung's obligations are limited to the repair or, at its discretion, replacement of the product or the defective part.
3. Warranty repairs must be carried out by Authorised Samsung Dealers or Authorised Service Centres. No re-imbusement will be made for repairs carried out by non Samsung Dealers and, any such repair work and damage to the products caused by such repair work will not be covered by this warranty.
4. This product is not considered to be defective in materials nor workmanship by reason that it requires adaptation in order to conform to national or local technical or safety standards in force in any country other than the one for which the product was originally designed and manufactured.
5. This warranty covers none of the following:
 - a) Periodic check ups, maintenance and repair or replacement of parts due to normal wear and tear.
 - b) Cost relating to transport, removal or installation of the product.
 - c) Misuse, including the failure to use this product for its normal purposes or incorrect installation.
 - d) Damage caused by Lightning, Water, Fire, Acts of God, War, Public Disturbances, incorrect mains voltage, improper ventilation or any other cause beyond the control of Samsung.
 - e) Spillage of food or liquid or use of any other hazardous substances, which may effect the product.
 - f) Performance due to differences in broadcasting method between countries

6. This warranty is valid for any person who legally acquired possession of the product during the warranty period.
7. The consumers statutory rights in any applicable national legislation whether against the retailer arising from the purchase contract or otherwise are not affected by this warranty. Unless there is national legislation to the contrary, the rights under this warranty are the consumers sole rights and Samsung, its subsidiaries and distributors shall not be liable for indirect or consequential loss or any damage to records, compact discs, videos or audio taper or any other related equipment or material.
8. Some products may differ from these guidelines. Please check with your dealer or the local Samsung web-site.

Wiring the Mains Power Supply Plug (UK Only)

IMPORTANT NOTICE

The mains lead on this equipment is supplied with a moulded plug incorporating a fuse. The value of the fuse is indicated on the pin face of the plug and, if it requires replacing, a fuse approved to BS11362 of the same rating must be used.

Never use the plug with the fuse cover omitted if the cover is detachable. If a replacement fuse cover is required, it must be of the same colour as the pin face of the plug. Replacement covers are available from your dealer.

If the fitted plug is not suitable for the power points in your house or the cable is not long enough to reach a power point, you should obtain a suitably approved extension lead or consult your dealer for assistance. However, if there is no alternative but to cut off the plug, remove the fuse and then safely dispose of the plug.

Do NOT connect the plug to a mains socket as there is a risk of shock hazard from the bared flexible cord.

IMPORTANT

The wires in the mains lead are coloured in accordance with the following code:
BLUE - NEUTRAL BROWN - LIVE

As these colours may not correspond to the coloured markings identifying the terminals in your plug, proceed as follows : The wire coloured BLUE must be connected to the terminal marked with the letter N or coloured BLUE or BLACK. The wire coloured BROWN must be connected to the terminal marked with the letter L or coloured BROWN or RED.

WARNING

DO NOT CONNECT EITHER WIRE TO THE EARTH TERMINAL, WHICH IS MARKED WITH THE LETTER E OR BY THE EARTH SYMBOL , OR COLOURED GREEN OR GREEN AND YELLOW.