

Panasonic[®]

Model No.
TX-32A400B

Operating Instructions LCD Television



VIERA

Thank you for purchasing this Panasonic product.
Please read these instructions carefully before operating this product and retain them for future reference.
The images shown in this manual are for illustrative purposes only.

English

UK and Ireland model

Transport only in upright position

Panasonic does not guarantee operation and performance of peripheral devices made by other manufacturers; and we disclaim any liability or damage arising from operation and/ or performance from usage of such other maker's peripheral devices.

This product is licensed under the AVC patent portfolio license for the personal and non-commercial use of a consumer to (i) encode video in compliance with the AVC Standard ("AVC Video") and/or (ii) decode AVC Video that was encoded by a consumer engaged in a personal and non-commercial activity and/or was obtained from a video provider licensed to provide AVC Video. No license is granted or shall be implied for any other use. Additional information may be obtained from MPEG LA, LLC. See <http://www.mpegla.com>.

Notice for DVB / Data broadcasting

This TV is designed to meet the standards (as of August, 2013) of digital services.

- Not all the features are available depending on the country, area, broadcaster, service provider and network environment.
- The compatibility with future services is not guaranteed.
- Check the latest information on the available services at the following website.
<http://panasonic.jp/support/global/cs/tv/>

Contents

Be Sure to Read

Safety Precautions	3
Maintenance	5

Quick Start Guide

Accessories / Options	6
Basic Connection	10
Identifying Controls	13
Auto Setup	14

Basic Features

Watching TV.....	15
How to Use Menu Functions	17

Advanced features

Using Media Player	23
--------------------------	----

Others

FAQs	26
Specifications	27
Licence	31

Safety Precautions

Warning

To help avoid risk of electrical shock, fire, damage or injury, please follow the warnings below:

■ Mains plug and lead

- This TV is designed to operate on AC 220-240 V, 50/60 Hz.
- Insert the mains plug fully into the socket outlet.
- Ensure that the mains plug is easily accessible.
- Remove the mains plug when cleaning the TV.

- Do not touch the mains plug with a wet hand.



- If you detect anything unusual, immediately switch off the mains supply switch and remove the mains plug.

AC 220-240 V

50/60 Hz



- Do not damage the mains lead.

- Do not place a heavy object on the lead.



- Do not place the lead near a high temperature object.



- Do not pull on the lead. Hold onto the mains plug body when disconnecting the plug.





- Do not move the TV with the lead plugged into a socket outlet.
- Do not twist the lead, bend it excessively or stretch it.
- Do not use a damaged mains plug or socket outlet.
- Ensure the TV does not crush the mains lead.
- Do not use any mains lead other than that provided with this TV.

IMPORTANT: THE MOULDED MAINS PLUG

FOR YOUR SAFETY, PLEASE READ THE FOLLOWING TEXT CAREFULLY.

This TV is supplied with a moulded three pin mains plug for your safety and convenience.

A 5 amp fuse is fitted in this mains plug. Shall the fuse need to be replaced, please ensure that the replacement fuse has a rating of 5 amps and that it is approved by ASTA or BSI to BS1362.

Check for the ASTA mark  or the BSI mark  on the body of the fuse.

If the mains plug contains a removable fuse cover, you must ensure that it is refitted when the fuse is replaced.

If you lose the fuse cover the mains plug must not be used until a replacement cover is obtained.

A replacement fuse cover may be purchased from your local dealer.

Do not cut off the mains plug.

Do not use any other type of mains lead except the one supplied with this TV.

The supplied mains lead and moulded plug are designed to be used with this TV to avoid interference and for your safety.

If the socket outlet in your home is not suitable, get it changed by a qualified electrician.

If the plug or mains lead becomes damaged, purchase a replacement from an authorized dealer.

How to replace the fuse

For plug type shown in example 1:

Lift out the removable fuse compartment with a screwdriver and replace the fuse, then refit securely into the mains plug (see example 1).

For plug type shown in example 2:

Lift open the fuse compartment, in the mains plug, with a screwdriver, and replace the fuse, then press the fuse cover down securely (see example 2).

Example 1

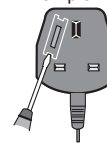

Example 2

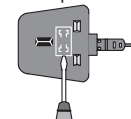

Warning

Take care

To help avoid risk of electrical shock, fire, damage or injury, please follow the warnings below:

- Do not remove covers and never modify the TV yourself as live parts are accessible when they are removed. There are no user serviceable parts inside.
- Do not expose the TV to rain or excessive moisture. This TV must not be exposed to dripping or splashing water and objects filled with liquid, such as vases, must not be placed on top of or above the TV.
- Do not expose the TV to direct sunlight and other sources of heat. To prevent fire never place any type of candle or naked flame on top or near the TV.
- Do not place the TV on sloped or unstable surfaces, and ensure that the TV does not hang over the edge of the base.



- Do not insert foreign objects into the TV through the air vents.
- Do not use an unapproved base / mounting equipment. Be sure to ask your local Panasonic dealer to perform the setup or installation of approved wall-hanging brackets.
- Do not apply strong force or impact to the display panel.
- This TV is designed for Table-top use.

To prevent the spread of fire, keep candles or other open flames away from this product at all times



Small object

This product contains possibly dangerous parts that can be breathed in or swallowed by young children accidentally.

- Keep the dangerous parts out of reach of young children.

Caution

Ventilation

Allow sufficient space around the TV in order to help prevent excessive heat, which could lead to early failure of some electronic components.

- Ventilation should not be impeded by covering the ventilation openings with items such as newspapers, tablecloths and curtains.

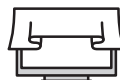

Minimum distance

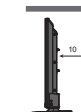

- Whether you are using the base or not, always ensure the vents in the bottom of the TV are not blocked and there is sufficient space to enable adequate ventilation.

■ Moving the TV

Before moving the TV, disconnect all cables.

■ When not in use for a long time

This TV will still consume some power even in the Off mode, as long as the mains plug is still connected to a live socket outlet.

- Remove the mains plug from the wall socket when the TV is not in use for a prolonged period of time.

■ Excessive volume

Do not expose your ears to excessive volume from the headphones.

Irreversible damage can be caused.



Maintenance

First, remove the mains plug from the socket outlet.

Display panel, Cabinet, Base

Regular care:

Gently wipe the surface of the display panel, cabinet, or base by using a soft cloth to clean the dirt or fingerprints.

For stubborn dirt:

First clean the dust on the surface. Dampen a soft cloth with clean water or diluted neutral detergent (1 part detergent to 100 parts water). Wring the cloth and wipe the surface. Finally, wipe away all the moisture.

Caution

- Do not use a hard cloth or rub the surface too hard, otherwise this may cause scratches on the surface.
- Take care not to subject the TV's surfaces to water or detergent. Liquid inside the TV could lead to product failure.
- Take care not to subject the surfaces to insect repellent, solvent, thinner or other volatile substances. This may degrade surface quality or cause peeling of the paint.
- The surface of the display panel is specially treated and may be easily damaged. Take care not to tap or scratch the surface with your fingernail or other hard objects.
- Do not allow the cabinet and base to make contact with a rubber or PVC substance for a long time. This may degrade surface quality.

Mains plug

Wipe the mains plug with a dry cloth at regular intervals. Moisture and dust may lead to fire or electrical shock.

Accessories / Options

Standard accessories

Remote Control

- N2QAYB000816



Assembly screw for base (4)

- ➔ (p. 8)



M4 × 16 mm

Batteries for the Remote Control (2)

- (R6-AA)

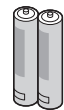

➔ (p. 6)

Operating Instructions

Base

- ➔ (p. 8)

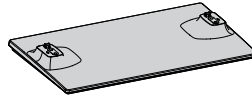

Production Registration Leaflet

Mains Lead

- ➔ (p. 10)

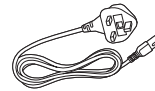

Quick Start Guide

Accessories / Options

- Accessories may not be placed all together. Take care not to throw them away unintentionally.
- This product contains possibly dangerous parts (such as plastic bags), that can be breathed in or swallowed by young children accidentally. Keep these parts out of reach of young children.

Installing / removing remote's batteries

1 Remove the battery compartment cover.

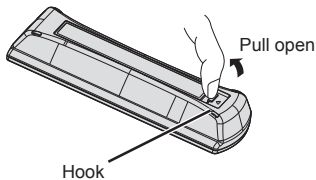

2 Insert two R6-AA batteries (1.5V) according to "+" and "-" polarity markings inside the battery compartment, then close the battery compartment cover.

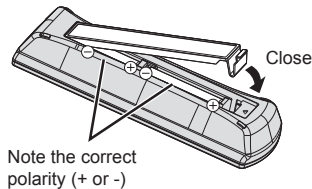

Caution

- Incorrect installation may cause battery leakage and corrosion, resulting in damage to the remote control.
- Do not mix old and new batteries.
- Replace only with same or equivalent type. Do not mix different battery types (such as alkaline and manganese batteries).
- Do not use rechargeable (Ni-Cd) batteries.
- Do not burn or break up batteries.
- Do not expose batteries to excessive heat such as sunshine, fire or the like.
- Make sure you dispose of batteries correctly.
- Ensure batteries are replaced correctly, there is danger of explosion and fire if battery is reversed.
- Do not disassemble or modify the remote control.

Optional accessories

Please contact your local Panasonic dealer to purchase the recommended optional accessories. For additional details, please read the manual of the optional accessories.

Wall-hanging bracket

Please contact your local Panasonic dealer to purchase the recommended wall-hanging bracket.

- Holes for wall-hanging bracket installation

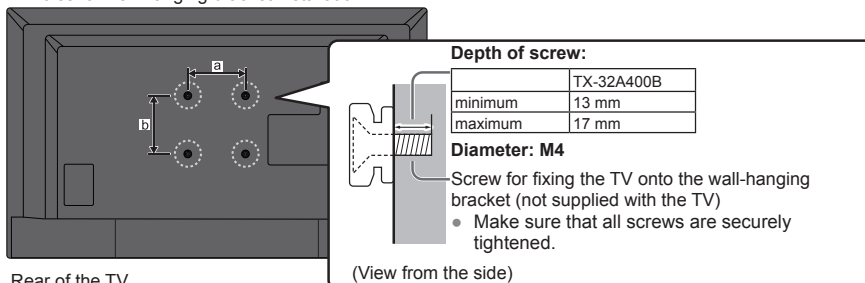

Rear of the TV

- TX-32A400B
- a: 100 mm
- b: 100 mm

Warning

- Using other wall-hanging brackets, or installing a wall hanging bracket by yourself have the risk of personal injury and product damage. In order to maintain the unit's performance and safety, be absolutely sure to ask your dealer or a licensed contractor to secure the wall-hanging brackets. Any damage caused by installing without a qualified installer will void your warranty.
- Carefully read the instructions accompanying optional accessories, and be sure to take steps to prevent the TV from falling off.
- Handle the TV carefully during installation since subjecting it to impact or other forces may cause product damage which will void your warranty.
- Do not mount the unit directly below ceiling lights (such as spotlights or halogen lights) which typically give off high heat. Doing so may warp or damage plastic cabinet parts.
- Take care when fixing wall brackets to the wall. Wall mounted equipment shall not be grounded by metal within the wall. Always ensure that there are no electrical cables or pipes in the wall before hanging bracket.
- To prevent fall and injury, remove the TV from its fixed wall position when no longer in use.

Attaching / removing the base

Warning

Do not disassemble or modify the base.

- Otherwise the TV may fall over and become damaged, and personal injury may result.

Caution

Do not use any base other than the one provided with this TV.

- Otherwise the TV may fall over and become damaged, and personal injury may result.

Do not use the base if it becomes warped or physically damaged.

- If you use the base while it is physically damaged, personal injury may result. Contact your local Panasonic dealer immediately.

During set-up, make sure that all screws are securely tightened.

- If insufficient care is taken to ensure screws are properly tightened during assembly, the base will not be strong enough to support the TV, and it might fall over and become damaged, and personal injury may result.

Ensure that the TV does not fall over.

- If the TV is knocked or children climb onto the base with the TV installed, the TV may fall over and personal injury may result.

Two or more people are required to install and remove the TV.

- If two or more people are not present, the TV may be dropped, and personal injury may result.

When removing the base from the TV, do not remove the base by the methods other than the specified procedure. → (see below)

- Otherwise the TV and / or base may fall over and become damaged, and personal injury may result.

Assembly screws for base (4)



M4 × 16 mm

Base

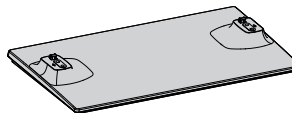

- 1** Place the TV screen face-down on a cushioned, clean surface to protect the screen from damages and scratches.

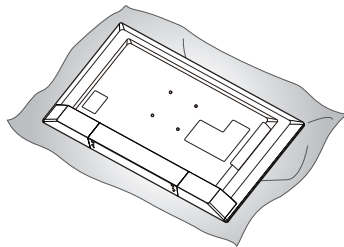

- 2** Insert the base hook into the bottom hole of the TV.
- Please remove the mylar of base before installing.

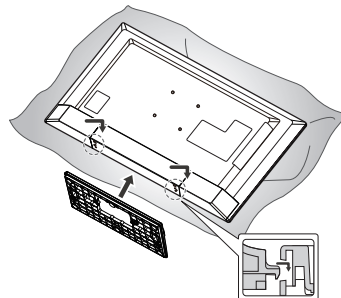

- 3** Use the assembly screws for base to fasten the base securely to the TV.

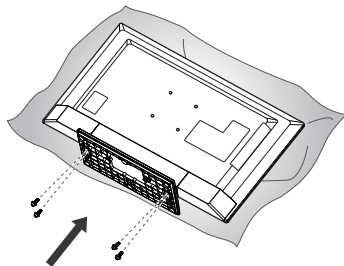

- 4** Please be sure to fasten assembly screws with screw driver.

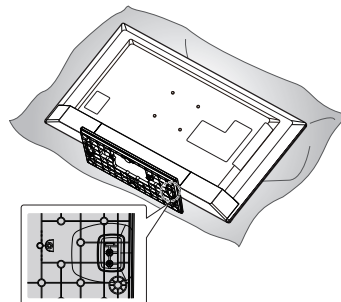

Indicator / Control panel

1 Remote control signal receiver

- Do not place any objects between the TV remote control signal receiver and remote control.

2 Power indicator

Red: Standby

Green: On

- The LED blinks when the TV receives a command from the remote control.

3 \odot /I (POWER)

- Switches TV on or off.
- To completely turn off the TV, please remove the mains lead from the wall socket.

4 INPUT / OK

- Selects an input source.
- Confirms and enters a selection on the On-Screen Display Menu.

5 MENU

- Opens or closes the On-Screen Display Menu.

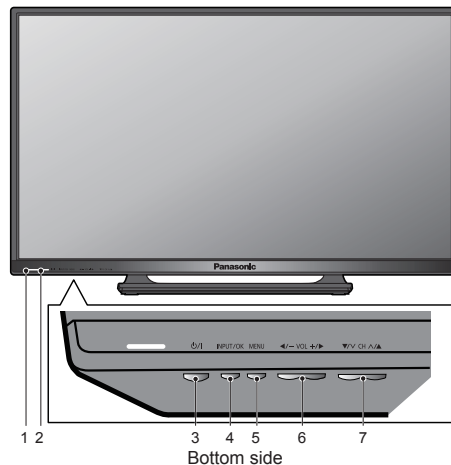

6 VOL + / -

- Changes volume.
- Adjusts the value of the selected item on the On-Screen Display Menu.

7 CH \blacktriangle / \blacktriangledown

- Changes channels.
- Selects item on the On-Screen Display Menu.

Note

- If the TV is turned off by \odot /I (POWER) button on the bottom of the TV, you cannot switch TV power on by \odot button of the remote control. Please press \odot /I (POWER) button again on the bottom of the TV to turn the TV on.

Using the On-Screen Displays - Operation guide

Many features available on this TV can be accessed via the On-Screen Display menu.

■ Operation guide

Operation guide will help you to operate by using the remote control.

Example: [Sound]

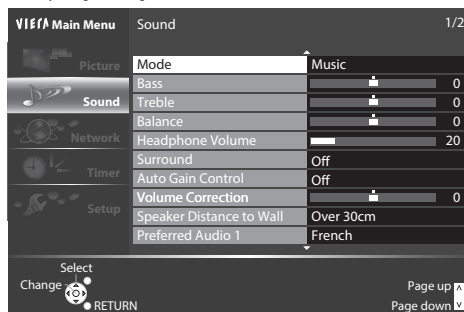

Operation guide

■ How to use remote control

MENU



- Open the main menu



- Move the cursor / select from a range of options / select the menu item (up and down only) / adjust levels (left and right only)



- Access the menu / store settings after adjustments have been made or options have been set

BACK/
RETURN



- Return to the previous menu

EXIT



- Exit the menu system and return to the normal viewing screen

Auto power standby function

The TV will automatically go into Standby mode in the following conditions:

- [Off Timer] is active in the [Timer]. (p. 21)
- No operation is performed for the period selected in [Auto Standby]. (p. 21)

Basic Connection

External equipment and cables shown are not supplied with this TV.

Please ensure that the unit is disconnected from the mains socket before attaching or disconnecting any leads.

Terminals

Quick Start Guide

Basic Connection

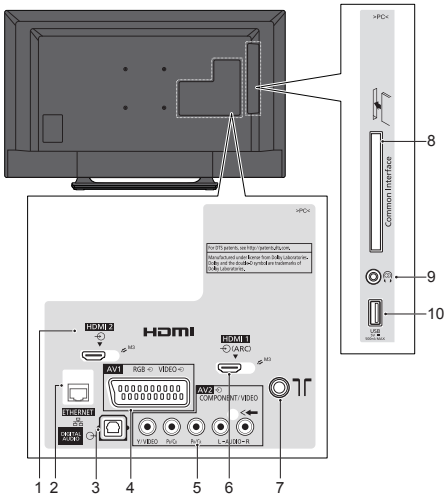

- 1 HDMI 2 ➔ (p. 11)
- 2 ETHERNET
- 3 DIGITAL AUDIO
- 4 AV 1 (SCART) ➔ (p. 11)
- 5 AV 2 (COMPONENT / VIDEO)
- 6 HDMI 1 (ARC) ➔ (p. 11)
- 7 Terrestrial terminal (see below)
- 8 CI slot
- 9 Headphone jack
- 10 USB port

Connections

Mains lead and aerial

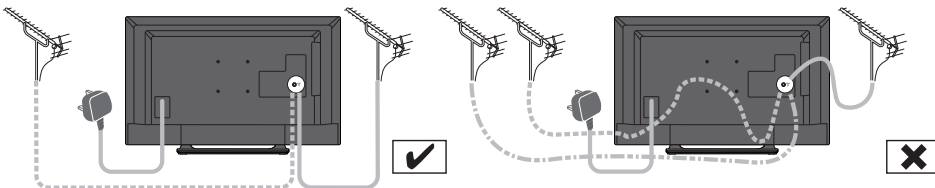
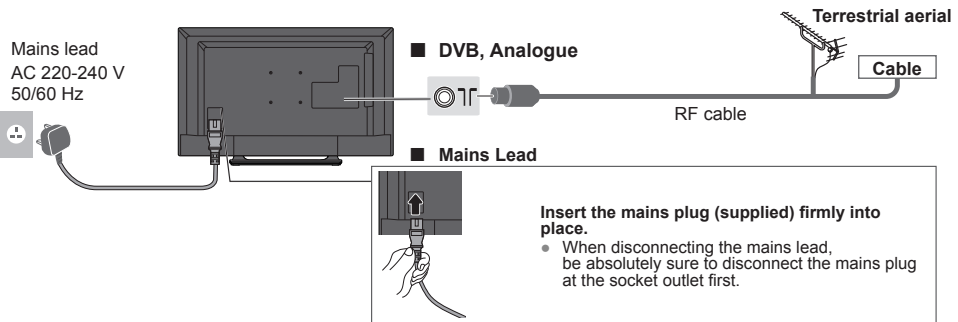

If the aerial is placed in the wrong location, interference might happen.

Note

- Do not put the Coaxial cable close to the mains lead to avoid noise.
- Do not place the Coaxial cable under the TV.
- To obtain optimum quality picture and sound, an Aerial, the correct cable (75 Ω coaxial) and the correct terminating plug are required.
- If a communal Aerial system is used, you may require the correct connection cable and plug between the wall Aerial socket and the TV.
- Your local Television Service Centre or dealer may be able to assist you in obtaining the correct Aerial system for your particular area and the accessories required.
- Any matters regarding Aerial installation, upgrading of existing systems or accessories required, and the costs incurred, are the responsibility of you, the customer.

AV devices

■ Player

TV



■ DVD Recorder / VCR

TV

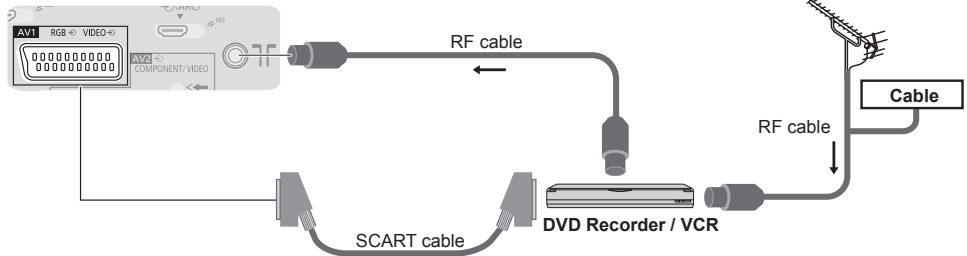

■ DVD Recorder / VCR and Set top box

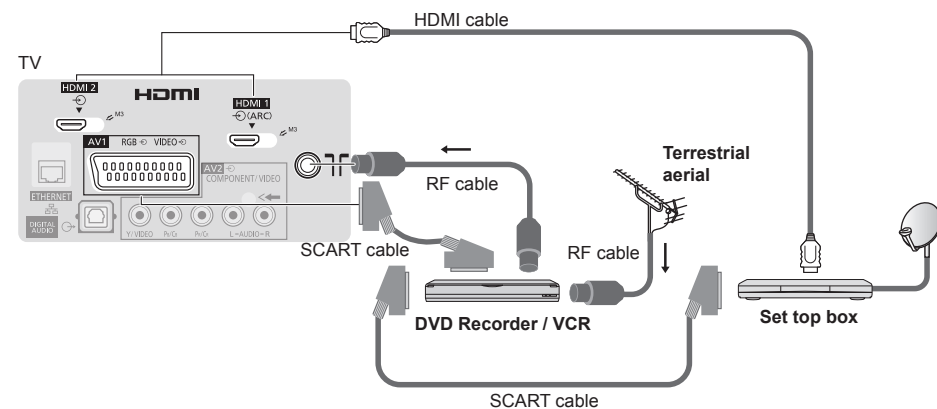

Note

- Please also read the manual of the equipment being connected.
- Keep the TV away from electronic equipment (video equipment, etc.) or equipment with an infrared sensor. Otherwise, distortion of image / sound may occur or operation of other equipment may be interfered.
- When using a SCART or HDMI cable, use the fully wired one.
- Check the type of terminals and cable plugs are correct when connecting.

Network connections

Connect the TV and the Broadband network equipment (modem, hub, or router) by using a LAN cable.

- If you do not have a Broadband network services, please consult your retailer for assistance.
- Confirm the term and conditions of the contracts with your Internet Service Provider (ISP) or telecommunications company.
- Set up and connect any equipment required for the network environment.
- Read the manual of the network equipment, too.

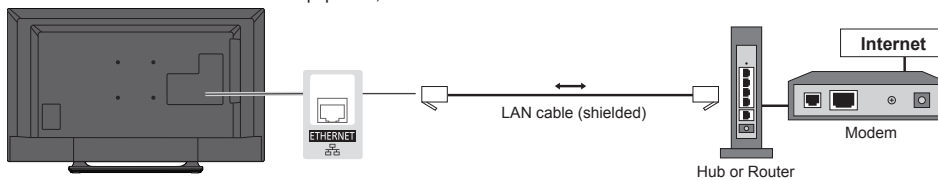

Note

- Depending on the ISP or telecommunications company, the required equipment and the internet connection procedure are different. Ensure that you use the network equipment that are authorized by your ISP and telecommunications company.
- You cannot make settings for the network equipment on this TV. You may be required to make settings on your computer.
- Depending on the terms and conditions of the contracts with your ISP or telecommunications company, additional fees may be charged or multiple connections to the internet may be impossible.
- Please contact your ISP or telecommunications company if you require further assistance regarding the network equipment.

Identifying Controls

Remote Control

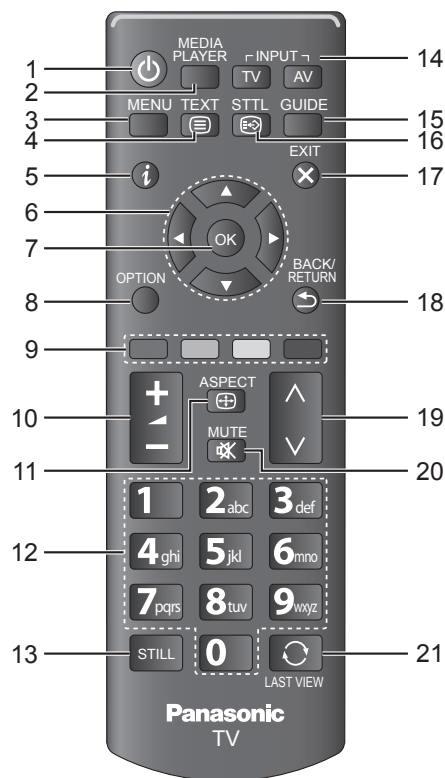

- 1 **Standby On / Off switch**
 - Switches TV on or off standby.
 - If you cannot turn the TV power on by pressing **⏻** button of the remote control, please press **⏻** / **⏻** (POWER) button on the bottom of the TV.
- 2 **MEDIA PLAYER** ➔ (p. 24)
 - Switches to USB device viewing / listening mode.
- 3 **MENU** ➔ (p. 17)
 - Press to access [Picture], [Sound], [Network], [Timer], and [Setup].
- 4 **TEXT**
 - Switches to teletext mode.
- 5 **i (Information)**
 - Displays channel and programme information.
- 6 **Cursor buttons**
 - Makes selections and adjustments.

- 7 **OK**
 - Confirms selections and choices.
 - Press after selecting channel positions to quickly change channel.
 - Displays the Channel List.
- 8 **OPTION**
 - Easy optional setting for viewing, sound, etc.
- 9 **Coloured buttons (red-green-yellow-blue)**
 - Used for the selection, navigation and operation of various functions.
- 10 **▲ / ▼ (Volume up / Volume down)**
 - Changes volume.
- 11 **⊞ ASPECT ➔ (p. 16)**
 - Changes aspect ratio.
- 12 **Numeric buttons**
 - Changes channel and teletext pages.
 - Sets characters.
 - When in Standby mode, switches TV on.
- 13 **STILL**
 - Freezes / unfreezes the picture. ➔ (p. 15)
 - Holds the current teletext page (teletext mode).
- 14 **Input mode selection**
 - **INPUT-TV** - Switches to TV mode.
 - **INPUT-AV** - Switches to AV input mode from [Input Selection] list.
- 15 **GUIDE**
 - Displays TV guide.
- 16 **STTL ➔ (p. 15)**
 - Displays subtitles.
- 17 **✕ EXIT**
 - Returns to the normal viewing screen.
- 18 **↶ BACK/RETURN**
 - Returns to the previous menu / page.
- 19 **▲ / ▼ (Channel up / Channel down)**
 - Selects channel in sequence.
- 20 **MUTE**
 - Switches sound mute on or off.
- 21 **⌛ LAST VIEW ➔ (p. 15)**
 - Switches to previously viewed channel.

Auto Setup

Search and store TV channels automatically.

- These steps are not necessary if the setup has been completed by your local dealer.
- Please complete connections (p. 10, 11) and settings (if necessary) of the connected equipment before starting Auto Setup. For details of settings for the connected equipment, read the manual of the equipment.

Quick Start Guide

Auto Setup

1 Plug the TV into mains socket and switch On

⏻/⏪



- Takes a few seconds to be displayed.
- If the red LED shows on the TV, press the Standby On / Off switch on the remote control.

2 Select your country



① select

② access

3 Start tuning

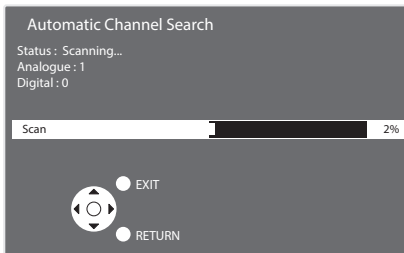

- Auto Setup will start to search for TV channels and store them in the numbered order as specified by the broadcasters.
- Actual number of channels may differ due to channel duplication.

5 Select [Home]

Select [Home] viewing environment to use in your home environment.

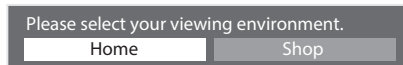

① change

② confirm

■ [Shop] viewing environment (for shop display only)

[Shop] viewing environment is the demonstration mode to explain main features of this TV.

Select [Home] viewing environment to use in your home environment.

- You can return to viewing environment selection screen at the stage of [Shop] confirmation screen.

1 Return to viewing environment selection screen

2 Select [Home]

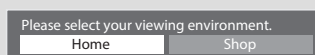
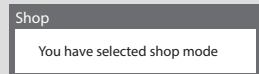

① change

② confirm

To change viewing environment later on, you will need to initialise all settings by accessing [Shipping Condition]. ➔ [Shipping Condition] (p. 22)

Auto Setup is now complete and your TV is ready for viewing.

Watching TV

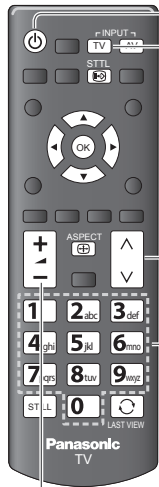

1 Turn power on



2 Switch to TV mode



3 Select a channel



or



• To select a more than two-digit channel position number, e.g. 399



Volume

Watching TV

Other useful functions

■ Display subtitles

Display / hide subtitles (if available)



- To change the language for DVB (if available) ➔ [Subtitle language]

OPTION



Selects the language in which subtitles should appear (if available)

■ Last view

Switch to previously viewed channel easily.



LAST VIEW

- Press again to return to the present view.

■ Still

Freeze / unfreeze picture



■ Off Timer

Turn the TV to Standby mode automatically after a fixed period.

- You can set the [Off Timer] via the [Timer]. ➔ (p. 21)
- To cancel, set to [Off] or turn the TV off.
- When the remaining time is within 3 minutes, the remaining time will flash on the screen.

Display the input selection menu



- Press to return to TV.
- Press to display the input selection menu.
- Selects the input mode connected to the equipment.

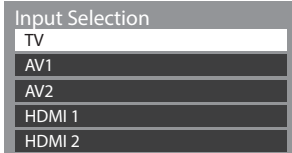

① select

② access

- You can also select the input using **INPUT-AV** button on the remote control or the bottom panel of TV.
- You can label or skip each input mode. ➔ [Input Labels] (p. 22)

Aspect

Change the aspect ratio (image size)

ASPECT Enjoy viewing the image at its optimum size and aspect.



Programmes usually contain an "Aspect Control Signal" (Widescreen signal, etc.), and the TV will choose the aspect ratio automatically according to the aspect control signal.

■ If you would like to change the aspect ratio manually

1 Display [Aspect Selection] list

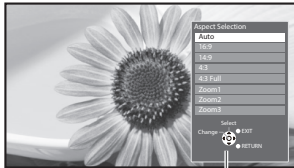

[Aspect Selection] list

2 While the list is displayed, select the mode



① select

② access

- You can also change the mode only using **ASPECT** button.

ASPECT



(Press repeatedly until you reach the desired mode)

Watching TV

[Auto]



The aspect ratio works automatically based on programmes signal format.

[16:9]



Directly displays the image at 16:9 without distortion (anamorphic).

[14:9]



Displays the image at the standard 14:9 without distortion.

[Just]



Displays a 4:3 image full-screen. Stretching is only noticeable at the left and right edges.

[4:3]



Displays the image at the standard 4:3 without distortion.

[4:3 Full]



Displays a 4:3 image enlarged horizontally to fit the screen.

[Zoom 1]



Displays a 16:9 letterbox or 4:3 image without distortion.

[Zoom 2]

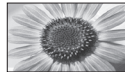

Displays a 16:9 letterbox (anamorphic) image full-screen without distortion.

[Zoom 3]

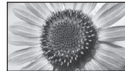

Displays a 2.35:1 letterbox (anamorphic) image full-screen without distortion.
At 16:9, displays the image at its maximum (with slight enlargement).

Note

- Aspect is fixed to [16:9] when [Viewing Mode] is set to [Game] in the [Picture]. (p. 18)
- Not available in teletext service.

How to Use Menu Functions

Various menus allow you to make settings for the picture, sound, and other functions.



1 Display the menu



- Displays the functions that can be set (varies according to the input signal)

2 Select the menu

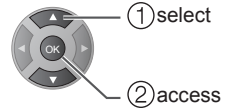
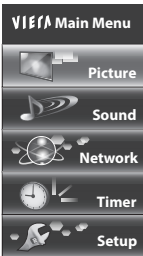

3 Select the item

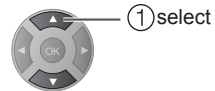
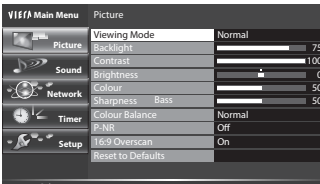

■ To return to TV at any time

EXIT



■ To return to the previous screen

BACK/RETURN



■ To change menu pages

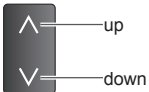

■ Choose from among alternatives

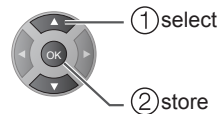
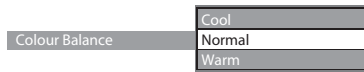

■ Adjust using the slide bar

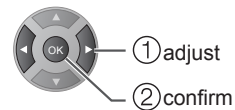

■ Go to the next screen



Displays the next screen



■ To reset the settings

- Picture or sound settings only
 - ➔ [Reset to Defaults] in the [Picture] (p. 19) or [Sound] (p. 20)
- To initialise all settings
 - ➔ [Shipping Condition] (p. 22)

Menu list

Menu	Item	Adjustments / Configurations (alternatives)
Picture	Viewing Mode	<p>Selects your favourite picture mode for each input. [Dynamic] / [Normal] / [Cinema] / [True Cinema] / [Game]</p> <p>[Dynamic]: Improves contrast and sharpness for viewing in a bright room.</p> <p>[Normal]: Normal use for viewing in a normal lighting condition.</p> <p>[Cinema]: Improves the performance of contrast, black and colour reproduction for watching movies in a darkened room.</p> <p>[True Cinema]: Reproduces the original image quality precisely without any revision.</p> <p>[Game]: Provides suitable images for fast response signal when playing games.</p> <ul style="list-style-type: none"> ● Not valid on TV mode ● To display a continuous record of time spent using [Game] mode ➔ [Playing Time Display] (p. 22) <p>In each viewing mode, [Contrast], [Brightness], [Colour], [Sharpness], [Tint], [Colour Balance], [P-NR], and [3D-COMB] can be adjusted and stored for each input.</p>
	Backlight, Contrast, Brightness, Colour, Sharpness	Increases or decreases the levels of these options according to your personal preference.
	Tint	Adjusts the picture hue to suit your taste. <ul style="list-style-type: none"> ● For NTSC signal reception
	Colour Balance	Sets the overall colour tone of the picture. [Cool] / [Normal] / [Warm]
	P-NR	Picture Noise Reduction Reduces unwanted picture noise and flicker noise in the contoured parts of a picture. [Off] / [Min] / [Mid] / [Max]
	3D-COMB	Makes still or slow moving pictures more vivid. [Off] / [On] <ul style="list-style-type: none"> ● Occasionally, while viewing still or slow moving pictures, colour patterning may be seen. Set to [On] to display sharper and more accurate colours. ● For PAL / NTSC signal reception in TV mode or from composite
	Colour Matrix	Selects image resolution of component-connected or HDMI-connected devices. <ul style="list-style-type: none"> ● Only for HDMI / YPbPr input source ● Only used with 480p or 576p video signal
	AV Colour System	Selects optional colour system based on video signals in AV mode: [Auto] / [PAL] / [SECAM] / [M.NTSC] / [NTSC] <ul style="list-style-type: none"> ● For AV input source only.
	16:9 Overscan	Selects the screen area displaying the image. [Off] / [On] [On]: Enlarges the image to hide the edge of the image. [Off]: Displays the image in the original size. <ul style="list-style-type: none"> ● Sets to [On] if noise is generated on the edge of the screen. ● This function is available when aspect is set to [16:9]. ● This function can be memorised separately for SD (Standard definition) and HD (High definition) signals.

Menu	Item	Adjustments / Configurations (alternatives)
Picture	Reset to Defaults	Press OK button to reset the current Picture [Viewing Mode] of the selected input to the default settings.
	Mode	<p>Selects your favourite sound mode. [Music] / [Speech] / [User]</p> <ul style="list-style-type: none"> The selected mode affects all input signals. <p>[Music]: Improves sound quality for watching music videos, etc.</p> <p>[Speech]: Improves sound quality for watching news, drama, etc.</p> <ul style="list-style-type: none"> Common sound settings are applied for [Music] and [Speech] mode but [Bass] and [Treble] settings are applied for each mode independently. <p>[User]: Adjusts the sounds manually by using the equaliser to suit your favourite sound quality.</p> <ul style="list-style-type: none"> For the [User] mode, [Equaliser] will appear on the [Sound] instead of [Bass] and [Treble]. Select [Equaliser] and adjust the frequency. ➔ [Equaliser] (see below)
Sound	Equaliser	<p>Adjusts the frequency level to suit your favourite sound quality.</p> <ul style="list-style-type: none"> This function is available when [Mode] is set to [User]. Select the frequency and change the frequency level by using the cursor button. To enhance the bass sound, raise the level of the lower frequency. To enhance the treble sound, raise the level of the higher frequency. To reset the levels of each frequency to the default settings, select [Reset to Defaults] by using the cursor button, and then press OK button.
	Bass	Adjusts level to enhance or minimise lower, deeper sound output.
	Treble	Adjusts level to enhance or minimise sharper, higher sound output.
	Balance	Adjusts volume level of right and left speakers.
	Headphone Volume	Adjusts the volume of the headphones.
	Surround	Surround sound settings. [Off] / [On]
	Auto Gain Control	Automatically regulates large sound level differences between channels and inputs. [Off] / [On]
	Volume Correction	Adjusts the volume of individual channel or input mode.
	Speaker Distance to Wall	<p>Compensates for the low frequency sound due to the distance between the speakers and the wall. [Over 30cm] / [Up to 30cm]</p> <ul style="list-style-type: none"> If the back space between the TV and wall is over 30 cm, [Over 30cm] is recommended. If the back space between the TV and wall is within 30 cm, [Up to 30cm] is recommended.
	Preferred Audio 1 Preferred Audio 2	Selects the first and second preferred language for DVB multi audio (depending on the broadcaster).
MPX	<p>Selects multiplex sound mode (if available)</p> <p>[Stereo]: Use this normally.</p> <p>[Mono]: When stereo signal cannot be received.</p> <p>[M1] / [M2]: Available while mono signal is transmitted.</p> <ul style="list-style-type: none"> For Analogue mode 	

Menu	Item	Adjustments / Configurations (alternatives)	
Sound	SPDIF Selection	<p>SPDIF: A standard audio transfer file format</p> <p>Selects the initial setting for digital audio output signal from DIGITAL AUDIO and HDMI 1 (ARC) (ARC function) terminals.</p> <p>[Auto] / [PCM]</p> <p>[Auto]: Dolby Digital Plus, Dolby Digital and HE-AAC multi-channel are output as Dolby Digital Bitstream. MPEG is output as [PCM]. DTS is output as DTS for video contents of [Media Player].</p> <p>[PCM]: Digital output signal is fixed to [PCM].</p> <ul style="list-style-type: none"> • ARC (Audio Return Channel) : A function of digital audio output using HDMI cable 	
	MPEG Optical Level	<p>Adjusts the audio level output from DIGITAL AUDIO terminal as the initial setting. [-12] / [-10] / [-8] / [-6] / [-4] / [-2] / [0] (dB)</p> <ul style="list-style-type: none"> • Normally, [PCM] sound is larger comparing with the other types of audio track. 	
	HDMI 1 Input(HDMI) HDMI 2 Input(HDMI)	<p>Selects to fit the input signal. [Digital] / [Analogue]</p> <p>[Digital]: When sound is carried via the HDMI cable connection.</p> <p>[Analogue]: When sound is not carried via the HDMI-DVI adaptor cable connection.</p> <ul style="list-style-type: none"> • For HDMI input only 	
	SPDIF Delay	<p>Adjusts the delay time of the sound output from DIGITAL AUDIO and HDMI 1 (ARC) (ARC function) terminals, if the sound does not synchronise the image.</p>	
	Downmix Mode	<p>Selects the output mode for listening to compressed music.</p> <p>[Surround] / [Stereo] / [Dual1] / [Dual2]</p> <ul style="list-style-type: none"> • For DVB mode 	
	Type	<p>Narration settings for impaired users (only available in some countries).</p> <p>[Normal] / [Hearing Impaired] / [Visually Impaired]</p> <ul style="list-style-type: none"> • [Hearing Impaired] ⇒ [Preferred Subtitle Type] (p. 22) • Set to [Visually Impaired] to activate the narration sound track when available on the broadcast. • [Visually Impaired] appears after you have selected this option. ⇒ (see below). • For DVB mode 	
	Visually Impaired	Speaker	Narration sound track is output to the TV speakers. [Off] / [On]
		Headphone	<p>Narration sound track is output to the headphone. [Off] / [On]</p> <ul style="list-style-type: none"> • Connect a headphone before selecting this option.
		Volume	Adjusts the volume of the narration sound track.
		Pan and Fade	<p>Sets the audio pan and fade effect. [Off] / [On]</p> <p>[Off] : Main Audio programme</p> <p>[On] : Controls the level of the Main Audio Programme and controls the pan of the Associated Audio Programme</p>
Reset to Defaults	<p>Press OK button to reset the current [Bass], [Treble], [Balance], [Headphone Volume], [Surround], [MPEG Optical Level], [Type], and [Visually Impaired] to the default settings.</p>		
Network	Interaction Channel	Interaction channel provides an extension of broadcast interactive services via broadcast transmission or IP connection.	
	MHEG PIN Protection	Ask the viewer to enter the PIN to allow presentation.	
	Internet Connection	Set to [On] to enable network settings.	

Menu	Item	Adjustments / Configurations (alternatives)	
Network	Information	Displays information of network connection.	
	IP Setting	Detects IP automatically or sets IP manually.	
	Connection Test	Check if the TV connects to the network successfully or not.	
Timer	Off Timer	Sets the time until the TV automatically goes to Standby mode. [Off] / [15] / [30] / [45] / [60] / [75] / [90] (minutes) (p. 15)	
	Auto Standby	Automatically turns the TV to Standby mode for energy saving when no operation is performed for 4 hours. [Off] / [2 hours] / [4 hours] <ul style="list-style-type: none"> Automatic input switching with the connected equipment affects this function and time-count will be reset. The notification message will appear 3 minutes before going into Standby mode. 	
Setup	Link Settings	CEC	When set to [On], the TV will automatically switch to the appropriate HDMI input whenever an HDMI connected equipment is initially turned on and the Play mode is selected. [Off] / [On] <ul style="list-style-type: none"> The HDMI CEC feature of connected HDMI CEC-compatible device must be turned on.
		Power off Link	When set to [On], all HDMI connected equipment will be turned off automatically by turning off the TV. [Off] / [On] <ul style="list-style-type: none"> A Panasonic DVD Recorder will not turn off if it is still in the Rec mode. The TV remains on even if all the HDMI connected equipment are turned off.
	Child Lock	Locks a channel / AV input to prevent access to it.	
	Tuning Menu	Automatic Channel Search	Automatically searches for the receivable channels.
		Scan	Adds newly found channels while keeping existing channels.
		Analogue Manual Tuning	Searches for the analogue channels manually.
		DVB-T Signal Condition	Checks the DVB-T signal condition.
		DVB-T Manual Tuning	Searches for the DVB-T channels manually.
		Favourite Network Select	Selects your favourite network for each broadcasters (only available in some countries). <ul style="list-style-type: none"> For DVB mode
		Favourites Edit	Creates a list of favourite channels.
		Skip	Skips unwanted channels.
		Sort	Sorts channels.
ChannelListEdit		Edits channels.	
Clear block	Clears the channel lists.		

Menu	Item	Adjustments / Configurations (alternatives)
Display Settings	Preferred Teletext	Selects the preferred language for DVB teletext service (depending on the broadcaster).
	Teletext Character Set	Selects teletext language. [West] / [East1] / [East2] [West] : English, French, German, Greek, Italian, Spanish, Swedish, Turkish, etc. [East1] : Czech, English, Estonian, Lettish, Rumanian, Russian, Ukrainian, etc. [East2] : Czech, Hungarian, Lettish, Polish, Rumanian, etc.
	Preferred Subtitles 1 Preferred Subtitles 2	Selects the first and second preferred language for DVB subtitles (depending on the broadcaster). <ul style="list-style-type: none"> To display subtitles
	Preferred Subtitle Type	Selects the preferred subtitle type. [Normal] / [Hearing Impaired] <ul style="list-style-type: none"> [Hearing Impaired] provides aids in understanding and enjoyment with DVB subtitles (depending on the broadcaster). [Preferred Subtitles 1] / [Preferred Subtitles 2] are given priority.
	Input Labels	Accesses the input labels list to select the label of each input mode or set to skip unconnected one for easier identification and selection in [TV Selection] (p. 15), [Input Selection] or banner. <ul style="list-style-type: none"> To skip the input mode, select [Skip].
	Banner Display Timeout	Sets how long the Information banner stays on screen. [0 (No display)] / [1] / [2] / [3] / [4] / [5] / [6] / [7] / [8] / [9] / [10] (seconds)
	Playing Time Display	Sets to [On] to display a continuous record of time spent using [Game] mode in the top right of the screen every 30 minutes. [Off] / [On] <ul style="list-style-type: none"> This function is available when [Viewing Mode] is set to [Game]. ➔ (p. 18)
	Radio Mode	Sets the timer for turning off the screen automatically when a radio channel is selected [Off] / [5] / [10] / [15] / [20] (seconds) <ul style="list-style-type: none"> The sound is active even if the screen turns off. This function is effective in reducing power consumption when listening to a radio channel. Press any buttons except Standby, Volume Up / Down and Sound Mute buttons to turn the screen on. Not valid on Analogue mode
System Menu	Shipping Condition	Resets all settings to the original condition.
	Common Interface	Sets to watch encrypted channels, etc.
	System Update	Downloads new software to this TV.
	Software Licence	Displays the software licence information.
	Demo Settings	<ul style="list-style-type: none"> For [Shop] viewing environment.
	System Information	Displays the system information of this TV.
Power Save	Reduces brightness of picture to economise on power consumption. [Off] / [On]	

- A different menu will be displayed in the mode of [Media Player]. (p. 23)
- Only available items can be selected. **Example: Aerial**

Using Media Player

[Media Player] allows you to enjoy photo, video or music recorded on a USB Flash Memory.

Photo mode:

Still pictures recorded by digital cameras will be displayed.

Movie mode:

Moving pictures recorded by digital video cameras will be played back.

Music mode:

Digital music data will be played back.

- During the operation, audio signal is output from DIGITAL AUDIO and HDMI 1 (ARC) (ARC function) terminals. But no video signals are output. To use HDMI 1 (ARC) with ARC function, connect an amplifier that has ARC function.
- [Date] shows the date on which the recording was made by the recording equipment. The file without record of the date is shown "****/**/*****".
- The picture may not appear correctly on this TV depending on the recording equipment used.
- Display may take some time when there are many files and folders.
- Partly degraded files might be displayed at a reduced resolution.
- Picture setting may not work depending on the conditions.
- The folder and file names may be different depending on the digital camera or digital video camera used.

■ To insert or remove the USB Flash Memory

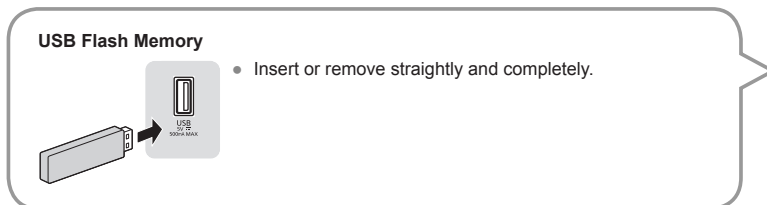

- For the supported file format → **“Supported file format in Media Player” (p. 29)**

Devices for playing back

■ USB Flash Memory (for playing back in [Media Player])

USB Flash Memory format:

FAT16, FAT32, NTFS

USB Flash Memory compliance:

Supports only USB1.1 or USB2.0 standard

Maximum USB capacity supported is 32GB

USB Hub or card adapter is not supported

Note

- Data modified with a PC may not be displayed.
- Do not remove the device while the TV is accessing data. Otherwise this can damage device or TV.
- Do not touch the pins on the device.
- Do not subject the device to a high pressure or impact.
- Insert the device in the correct direction. Otherwise this can damage device or TV.
- Electrical interference, static electricity, or erroneous operation may damage the data or device.
- Back up the recorded data at regular intervals in case of deteriorated or damaged data or erratic operation of the TV. Panasonic is not liable for any deterioration or damage of recorded data.

Starting Media Player

1 Insert the USB Flash Memory to the TV

→ (p. 23)

2 Start [Media Player]

- You can also start by pressing following button.



3 Select the content

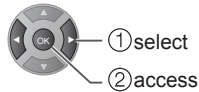

4 Enjoy [Media Player]

Example: Thumbnail - [All photos]



- To display the information of the highlighted content

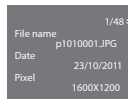

File number / Total file number

Selected device name

Using Media Player

Change the contents

You can switch to the other mode of [Media Player] from the thumbnail view.

- The mode can be switched in the current device.

1 While the thumbnail is displayed, display the contents selection

(blue)

2 Select the contents

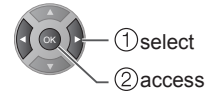

[Photo]

- Browsing Photos

Buttons	Description
Red	<ul style="list-style-type: none"> Play slideshow
Green	<ul style="list-style-type: none"> Selects viewing type
Yellow	<ul style="list-style-type: none"> Selects drive type
Blue	<ul style="list-style-type: none"> Selects [Photo], [Music], or [Movie]
▲ / ▼ / ◀ / ▶	<ul style="list-style-type: none"> Selects photos

[Music]

Buttons	Description
Red	<ul style="list-style-type: none"> Play folder
Yellow	<ul style="list-style-type: none"> Selects drive type
Blue	<ul style="list-style-type: none"> Selects [Photo], [Music], or [Movie]
▲ / ▼ / ◀ / ▶	<ul style="list-style-type: none"> Selects musics

[Movie]

Buttons	Description
Red	<ul style="list-style-type: none"> • Play folder
Yellow	<ul style="list-style-type: none"> • Selects drive type
Blue	<ul style="list-style-type: none"> • Selects [Photo], [Music], or [Movie]
▲ / ▼ / ◀ / ▶	<ul style="list-style-type: none"> • Selects movies

Option menu of [Photo]

Menu	Item	Adjustments / Configurations (alternatives)
Slideshow Settings	Transition Effect	<p>Selects the transition effect for switching the photo during the slideshow. [None] / [Dissolve] / [Wipe right] / [Wipe left] / [Wipe up] / [Wipe down] / [Box in] / [Box out] / [Random]</p> <p>[Dissolve]: Each photo is dissolved when switching to the next photo. [Wipe right]: The next photo slides over the preceding clip from left to right. [Wipe left]: The next photo slides over the preceding clip from right to left. [Wipe up]: The next photo slides over the preceding clip from bottom to top. [Wipe down]: The next photo slides over the preceding clip from top to bottom. [Box in]: A box shape expands from each of the four corners toward the center. [Box out]: A box shape expands from the center of each quadrant toward the corners of each quadrant. [Random]: Each transition is selected at random.</p>
	Screen Mode	<p>Selects enlarged or normal viewing on [Single view] and [Slideshow]. [Normal] / [Zoom]</p> <ul style="list-style-type: none"> • Depending on the photo size, it may not be fully enlarged to fill the screen, e.g. portrait style picture.
	Interval	Selects slideshow interval. [5] / [10] / [15] / [30] / [60] / [90] / [120] (seconds)
	Repeat	Slideshow repeat. [Off] / [On]
	Back Ground Music	<p>Selects the background music during [Photo] mode. [Off] / [Type1] / [Type2] / [Type3]</p> <ul style="list-style-type: none"> • [Type1], [Type2], and [Type3] are the fixed music each installed in this TV.

Option menu of [Music]

Menu	Item	Adjustments / Configurations (alternatives)
Music Setup	Repeat	Set play repeat function. [Off] / [Folder] / [One]

Option menu of [Movie]

Menu	Item	Adjustments / Configurations (alternatives)
Video Setup	Video Preview	<p>Sets to start the preview of the title or scene in the thumbnail view. [Off] / [On]</p> <ul style="list-style-type: none"> • Image may not be displayed for an instant in the thumbnail view. Set the preview [Off] to resolve this.
	Repeat	<p>Playback repeat within the title or selected file (depending on the content). [Off] / [On]</p>

FAQs

Before requesting service or assistance, please follow these simple guides to resolve the problem. If the problem still persists, please contact your local Panasonic dealer for assistance.

	Problem	Causes / Actions
Screen	Chaotic image, noisy	<ul style="list-style-type: none"> Set [P-NR] in the [Picture] to remove noise. ➔ (p. 18) Check nearby electrical products (car, motorcycle, fluorescent lamp).
	No image can be displayed	<ul style="list-style-type: none"> Is [Contrast], [Brightness] or [Colour] in the [Picture] set to the minimum? ➔ (p. 18)
	Blurry or distorted image (no sound or low volume)	<ul style="list-style-type: none"> Reset channels.
	Unusual image is displayed	<ul style="list-style-type: none"> Turn the TV to standby mode with Standby On / Off switch, then turn it on again. If the problem persists, initialise all settings. ➔ [Shipping Condition]
Sound	No sound is produced	<ul style="list-style-type: none"> Is "Sound mute" active? ➔ (p. 13) Is the volume set to the minimum?
	Sound level is low or sound is distorted	<ul style="list-style-type: none"> Sound signal reception may be deteriorated.
HDMI	Sound is unusual	<ul style="list-style-type: none"> Set the sound setting of the connected equipment to "2ch L.PCM". Check the [HDMI 1 Input(HDMI)] setting in the [Sound]. ➔ (p. 19) If digital sound connection has a problem, select analogue sound connection.
	Pictures from external equipment are unusual when the equipment is connected via HDMI	<ul style="list-style-type: none"> Check the HDMI cable is connected properly. Turn the TV and equipment off, then turn them on again. Check an input signal from the equipment. ➔ (p. 28) Use equipment compliant with EIA/CEA-861/861D.
Other	The TV does not switch on	<ul style="list-style-type: none"> Check the mains lead is plugged into the TV and the socket outlet.
	The TV goes into Standby mode	<ul style="list-style-type: none"> Auto power standby function is activated. ➔ (p. 9) The TV enters Standby mode about 30 minutes after analogue broadcasting ends.
	The remote control does not work or is intermittent	<ul style="list-style-type: none"> Are the batteries installed correctly? ➔ (p. 6) Has the TV been switched on? The batteries may be running low. Replace them. Point the remote control directly at the TV's remote control signal receiver (within about 7 m and a 30 degree angle of the signal receiver). Situate the TV away from sunshine or other sources of bright light not to shine on the TV's remote control signal receiver.
	Parts of the TV become hot	<ul style="list-style-type: none"> Even when the temperature of parts of the front, top and rear panels has risen, these temperature rises do not cause any problems in terms of performance or quality.
	The LCD panel moves slightly when it is pushed with a finger Clattered sound might be heard	<ul style="list-style-type: none"> There is a little gap around the panel to prevent damage to the panel. This is not a malfunction.
	Overcurrent error message appears	<ul style="list-style-type: none"> The connected USB device might cause this error. Remove the device and turn the TV to standby mode with Standby On / Off switch, then turn it on again. Check foreign objects are not inside the USB port.
	An error message appears	<ul style="list-style-type: none"> Follow the message's instructions. If the problem persists, contact your local Panasonic dealer or the authorised service centre.

Specifications

■ Product fiche

Supplier	Panasonic Corporation
Model ID	TX-32A400B
Energy efficiency class	A+
Visible screen size(diagonal)	80 cm / 31.5 inches (diagonal)
On mode average power consumption	30 W
Annual energy consumption*1	44 kWh
Off mode power consumption	0.3 W
Standby power consumption*2	0.3 W
Screen resolution	1,366 (W) × 768 (H)

*1: Energy consumption XYZ kWh per year, based on the power consumption of the television operating 4 hours per day for 365 days. The actual energy consumption will depend on how the television is used.

*2: When the TV is turned off with the remote control and no function is active.

For the information of rated power consumption, refer to the label on the TV back cover.

■ Other information

Model ID	TX-32A400B	
Power source	AC 220-240 V, 50/60 Hz	
Dimensions (W × H × D)	With Base: 727 mm × 464 mm × 194 mm Without Base (TV only): 727 mm × 432 mm × 67 mm	
Mass	With Base: 5.5 kg Without Base (TV only): 5.0 kg	
Aspect ratio	16:9	
Sound	Audio output	10 W (5 W + 5 W), 10% THD
	Headphones	3.5mm stereo mini Jack × 1
Broadcast System	Analogue: PAL-I Digital: DVB-T / T2	
Aerial input	VHF / UHF	
Operating conditions	Temperature : 0 °C - 35 °C Humidity : 20 % - 80 % RH (non-condensing)	

Note

- Design and Specifications are subject to change without notice. Mass and Dimensions shown are approximate.

Input signal that can be displayed

COMPONENT (Y, Pb, Pr), HDMI

Mode	H. Freq. (kHz)	V. Freq. (Hz)	COMPONENT	HDMI
525 (480) / 60i 16:9	15.73	59.94	○	○
525 (480) / 60i 4:3	15.73	59.94	○	○
525 (480) / 60p 16:9	31.47	59.94	○	○
525 (480) / 60p 4:3	31.47	59.94	○	○
625 (576) / 50i 16:9	15.625	50	○	○
625 (576) / 50i 4:3	15.625	50	○	○
625 (576) / 50p 16:9	31.25	50	○	○
625 (576) / 50p 4:3	31.25	50	○	○
750 (720) / 60p	45	59.94	○	○
750 (720) / 50p	37.5	50	○	○
1,125 (1,080) / 60i	33.75	59.94	○	○
1,125 (1,080) / 50i	28.125	50	○	○
1,125 (1,080) / 60p	67.43	59.94		○
1,125 (1,080) / 50p	56.25	50		○
1,125 (1,080) / 24p	26.97	23.98		○
1,125 (1,080) / 30p	33.75	29.97		○

Specifications

○ Mark : Applicable input signal

PC (from HDMI terminal)

Signal Name	H. Freq. (kHz)	V. Freq. (Hz)
640 × 480 @ 60Hz	31.47	59.94
800 × 600 @ 60Hz	37.88	60.32
1,024 × 768 @ 60Hz	48.36	60
1,280 × 768 @ 60Hz	47.78	59.87
1,280 × 768 @ 60Hz (CVT)	47.40	60
1,280 × 1,024 @ 60Hz	63.98	60.02
1,360 × 768 @ 60Hz	47.70	60
1,366 × 768 @ 60Hz	48.39	60.04
1,920 × 1,080 30P	33.75	30
1,920 × 1,080 60P	67.43	60

Note

- Signals other than above may not be displayed properly.
- The above signals are reformatted for optimal viewing on your display.
- PC signal is magnified or compressed for display, so that it may not be possible to show fine detail with sufficient clarity.

Supported file format in Media Player

■ Photo

Format	File extension	Image resolution (pixel)	Details / Restrictions
JPEG	.jpg .jpeg	Baseline jpeg: 4 × 4 to 17,000 × 10,000 Progressive jpeg: 4 × 4 to 4,000 × 4,000	DCF and EXIF standards Sub-sampling: 4:4:4, 4:2:2, 4:2:0

■ Movie

Container	File extension	Video codec	Audio codec	Details / Restrictions
AVI	.avi	H.264 BP/MP/HP MPEG4 SP/ASP	MP3 Dolby Digital MPEG1 Layer1/2 AAC HE-AAC	–
MKV	.mkv	H.264 BP/MP/HP	MP3 Dolby Digital MPEG1 Layer1/2 AAC HE-AAC DTS Core	–
ASF	.asf .wmv	VC-1 Windows Media Video Ver. 9	Windows Media Audio v8 Windows Media Audio v9 Dolby Digital MP3	<ul style="list-style-type: none"> • Copy-protected files cannot be played back.
MP4	.mp4 .m4v	H.264 BP/MP/HP	MP3 AAC HE-AAC	<ul style="list-style-type: none"> • This TV supports this container recorded by Panasonic products. For details, read the manual of the products.
TS	.ts .tp .trp	MPEG2 MP@HL H.264 BP/MP/HP	Dolby Digital Dolby Digital Plus MP3 AAC HE-AAC	–
PS	.mpg .mpeg .vro .vob	MPEG1 MPEG2 MP@HL	Dolby Digital MPEG1 Layer1/2 AAC DVD LPCM	–
FLV	.flv .f4v	H.264 BP/MP/HP	AAC MP3 HE-AAC	–
3GP	.3gp	H.264 BP/MP/HP MPEG4 SP/ASP	AAC HE-AAC	–

■ Music

Codec	File extension	Restrictions
MP3	.mp3	–
AAC	.m4a	● Copy-protected files cannot be played back.
WMA	.wma	● Copy-protected files cannot be played back. ● WMA Lossless is not supported.
LPCM	.wav	–
FLAC	.flac	–

Note

- Some files may not be played back even if they fulfill these conditions.
- Do not use two-byte characters or other special codes for data.
- The device may become unusable with this TV if the file or folder names are changed.
- Supported Video formats are different in Media Player and media server.

Licence

Even if no special notation has been made of company or product trademarks, these trademarks have been fully respected.

This product incorporates the following software:

- (1) the software licensed under the GNU General Public License, Version 2.0 (GPL V2.0) and/or,
- (2) open sourced software other than the software licensed under the GPL.

The software categorized as (1) - (2) are distributed in the hope that it will be useful, but WITHOUT ANY WARRANTY, without even the implied warranty of MERCHANTABILITY or FITNESS FOR A PARTICULAR PURPOSE. Please refer to the detailed terms and conditions thereof shown in the "Software Licence" menu on this product.

At least three (3) years from delivery of this product, Panasonic Corporation will give to any third party who contacts us at the contact information provided below, for a charge no more than our cost of physically performing source code distribution, a complete machine-readable copy of the corresponding source code covered under GPL V2.0 or the other licenses with the obligation to do so, as well as the respective copyright notice thereof.

Contact Information: cdrequest@unipf.jp

The source code and the copyright notice are also available for free in our website below.

<http://www.unipf.jp/dl/DTV13ET/>

DVB

- DVB and the DVB logos are trademarks of the DVB Project.

Dolby



- Manufactured under license from Dolby Laboratories. Dolby and the double-D symbol are trademarks of Dolby Laboratories.

HDMI



- HDMI, the HDMI logo, and High-Definition Multimedia Interface are trademarks or registered trademarks of HDMI Licensing LLC in United States and other countries.

HD TV



- The "HD TV" Logo is a trademark of DIGITALEUROPE.

DTS



- Manufactured under license under U.S. Patent Nos: 5,956,674; 5,974,380; 6,487,535 & other U.S. and worldwide patents issued & pending. DTS, the Symbol, & DTS and the Symbol together are registered trademarks & DTS 2.0+Digital Out is a trademark of DTS, Inc. Product includes software. © DTS, Inc. All Rights Reserved.

Freeview



Information for Users on Collection and Disposal of Old Equipment and used Batteries



These symbols on the products, packaging, and/or accompanying documents mean that used electrical and electronic products and batteries should not be mixed with general household waste. For proper treatment, recovery and recycling of old products and used batteries, please take them to applicable collection points, in accordance with your national legislation and the Directives 2002/96/EC and 2006/66/EC.

By disposing of these products and batteries correctly, you will help to save valuable resources and prevent any potential negative effects on human health and the environment which could otherwise arise from inappropriate waste handling.



For more information about collection and recycling of old products and batteries, please contact your local municipality, your waste disposal service or the point of sale where you purchased the items. Penalties may be applicable for incorrect disposal of this waste, in accordance with national legislation.

For business users in the European Union

If you wish to discard electrical and electronic equipment, please contact your dealer or supplier for further information.

[Information on Disposal in other Countries outside the European Union]

These symbols are only valid in the European Union. If you wish to discard these items, please contact your local authorities or dealer and ask for the correct method of disposal.

Note for the battery symbol (bottom two symbol examples) :

This symbol might be used in combination with a chemical symbol. In this case it complies with the requirement set by the Directive for the chemical involved.



Cd

Sales and Support information

Customer Communications Centre

- For customers within the U.K.: **0844 844 3899**
- For customers within Ireland: **01289 8333**
- Monday - Friday 9:00am - 5:00pm, (Excluding public holidays).
- For further support on your product, please visit our website: www.panasonic.co.uk

Direct Sales at Panasonic U.K.

- Order accessory and consumable items for your product with ease and confidence by phoning our Customer Communications Centre Monday - Friday 9:00am - 5:00pm, (Excluding public holidays).
 - Or go on line through our Internet Accessory ordering application at www.pas-europe.com
 - Most major credit and debit cards accepted.
 - All enquiries transactions and distribution facilities are provided directly by Panasonic U.K.
 - It couldn't be simpler!
 - Also available through our Internet is direct shopping for a wide range of finished products.
- Take a browse on our website for further details



Declaration of Conformity (DoC)

Authorized Representative :

Panasonic Testing Centre

Panasonic Marketing Europe GmbH

Winsbergring 15, 22525 Hamburg, Germany

Customer's Record

The model number and serial number of this product may be found on its rear panel. You should note this serial number in the space provided below and retain this book, plus your purchase receipt, as a permanent record of your purchase to aid in identification in the event of theft or loss, and for Warranty Service purposes.

Model Number

Serial Number

Panasonic UK, a branch of Panasonic Marketing Europe GmbH

Willoughby Road, Bracknell, Berkshire, RG12 8FP
Web Site: <http://panasonic.net>



X41G32MV03717B

© Panasonic Corporation 2014

T€H1 -0
Printed in Poland