

Panasonic®

Model No.
TX-39A400B
TX-42A400B
TX-50A400B

English

Operating Instructions LCD Television



VIERA

Thank you for purchasing this Panasonic product.

Please read these instructions carefully before operating this product and retain them for future reference.

The images shown in this manual are for illustrative purposes only.



TQB0E2453U-1



Contents

Be Sure to Read

Important Notice	3
Safety Precautions	3

Quick Start Guide

Accessories	5
Connections	7
Identifying Controls	10
First time Auto Setup	11

Using your VIERA

Watching TV	12
Viewing Text Service	14
Using TV Guide	15
Watching External Inputs	16
Using Menu Functions	17
Tuning and Editing Channels	21
Child Lock	23
Updating the TV Software	23
Using Media Player	24
Technical Information	26

Others

FAQs	28
Maintenance	29
Specifications	30

Even if no special notation has been made of company or product trademarks, these trademarks have been fully respected.

- DVB and the DVB logos are trademarks of the DVB Project.
- HDMI, the HDMI Logo, and High-Definition Multimedia Interface are trademarks or registered trademarks of HDMI Licensing LLC in the United States and other countries.
- Manufactured under license from Dolby Laboratories. Dolby and the double-D symbol are trademarks of Dolby Laboratories.
- For DTS patents, see <http://patents.dts.com>. Manufactured under license from DTS Licensing Limited. DTS, the Symbol, & DTS and the Symbol together are registered trademarks and DTS 2.0+Digital Out is a trademark of DTS, Inc. © DTS, Inc. All Rights Reserved.
- Windows is a registered trademark of Microsoft Corporation in the United States and other countries.

This product incorporates the following software:

- (1) the software licensed under the GNU General Public License, Version 2.0 (GPL V2.0) and/or,
- (2) open sourced software other than the software licensed under the GPL.

The software categorized as (1) - (2) are distributed in the hope that it will be useful, but WITHOUT ANY WARRANTY, without even the implied warranty of MERCHANTABILITY or FITNESS FOR A PARTICULAR PURPOSE. Please refer to the detailed terms and conditions thereof shown in the "Software License" menu on this product.

At least three (3) years from delivery of this product, Panasonic Corporation will give to any third party who contacts us at the contact information provided below, for a charge no more than our cost of physically performing source code distribution, a complete machine-readable copy of the corresponding source code covered under GPL V2.0 or the other licenses with the obligation to do so, as well as the respective copyright notice thereof.

Contact Information: cdrequest@unipf.jp

The source code and the copyright notice are also available for free in our website below.

<http://www.unipf.jp/dl/DTV13ET/>

Important Notice

Notice for DVB / Data broadcasting / IPTV functions

This TV is designed to meet the standards (as of August, 2013) of digital services.

- Not all the features are available depending on the country, area, broadcaster, service provider and network environment.
- The compatibility with future services is not guaranteed.
- Check the latest information on the available services at the following website.

<http://panasonic.net/viera/support>

This product is licensed under the AVC patent portfolio license for the personal and non-commercial use of a consumer to (i) encode video in compliance with the AVC Standard ("AVC Video") and/or (ii) decode AVC Video that was encoded by a consumer engaged in a personal and non-commercial activity and/or was obtained from a video provider licensed to provide AVC Video. No license is granted or shall be implied for any other use.

Additional information may be obtained from MPEG LA, LLC.

See <http://www.mpegla.com>.

Panasonic does not guarantee operation and performance of peripheral devices made by other manufacturers; and we disclaim any liability or damage arising from operation and/or performance from usage of such other maker's peripheral devices.

Transport only in upright position

Safety Precautions

To help avoid risk of electrical shock, fire, damage or injury, please follow the warnings and cautions below:

■ Mains plug and lead

Warning

If you detect anything unusual, immediately switch off the mains supply switch and remove the mains plug.

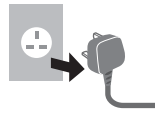

IMPORTANT:

THE MOULDED MAINS PLUG FOR YOUR SAFETY, PLEASE READ THE FOLLOWING TEXT CAREFULLY.

This TV is supplied with a moulded 3-pin mains plug for your safety and convenience.

A 5 amp fuse is fitted in this mains plug. Shall the fuse need to be replaced, please ensure that the replacement fuse has a 5 amp rating and that it is approved by ASTA or BSI to BS1362.

Check for the ASTA mark  or the BSI mark  on the fuse body.

If the mains plug contains a removable fuse cover, you must ensure that it is refitted when the fuse is replaced.

If you lose the fuse cover, the mains plug must not be used until a replacement cover is obtained.

A replacement fuse cover may be purchased from your local dealer.

Do not cut off the mains plug.

Do not use any other type of mains lead except the one supplied with this TV.

The supplied mains lead and moulded plug are designed to be used with this TV to avoid interference and for your safety.

If the socket outlet in your home is not suitable, get it changed by a qualified electrician.

If the plug or mains lead becomes damaged, purchase a replacement from an authorised dealer.

How to replace the fuse:

For plug type shown in example 1

Lift out the removable fuse cover with a screwdriver and replace the fuse, then refit it securely into the mains plug.

For plug type shown in example 2

Lift open the fuse cover in the mains plug with a screwdriver and replace the fuse, then press the fuse cover down securely.

Example 1



Example 2

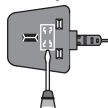

- This TV is designed to operate on AC 220-240 V, 50 / 60 Hz.

- Insert the mains plug fully into the socket outlet.
- Ensure that the mains plug is easily accessible.
- Disconnect the mains plug when cleaning the TV.
- Do not touch the mains plug with wet hands.



- Do not damage the mains lead.

- Do not place a heavy object on the lead.



- Do not place the lead near a high temperature object.



- Do not pull on the lead. Hold onto the mains plug body when disconnecting the plug.



- Do not move the TV with the lead plugged into a socket outlet.
- Do not twist the lead, bend it excessively or stretch it.
- Do not use a damaged mains plug or socket outlet.
- Ensure the TV does not crush the mains lead.

- Do not use any mains lead other than that provided with this TV.

Take care

Warning

- Do not remove covers and never modify the TV yourself as live parts are accessible when they are removed. There are no user serviceable parts inside.



- Do not expose the TV to rain or excessive moisture. This TV must not be exposed to dripping or splashing water and objects filled with liquid, such as vases, must not be placed on top of or above the TV.



- Do not insert foreign objects into the TV through the air vents.
- Do not use an unapproved pedestal / mounting equipment. Be sure to ask your local Panasonic dealer to perform the setup or installation of approved wall-hanging brackets.
- Do not apply strong force or impact to the display panel.

- Do not place the TV on sloped or unstable surfaces, and ensure that the TV does not hang over the edge of the base.



- This TV is designed for table-top use.

- Do not expose the TV to direct sunlight and other sources of heat.



To prevent the spread of fire, keep candles or other open flames away from this product at all times



Dangerous part / Small object

Warning

- This product contains possibly dangerous parts such as plastic bags, that can be breathed in or swallowed by young children accidentally. Keep these parts out of reach of young children.

Pedestal

Warning

- Do not disassemble or modify the pedestal.

Caution

- Do not use any pedestal other than the one provided with this TV.
- Do not use the pedestal if it becomes warped or physically damaged. If this occurs, contact your nearest Panasonic dealer immediately.
- During setup, make sure that all screws are securely tightened.
- Ensure that the TV does not suffer any impact during installation of the pedestal.
- Ensure that children do not climb onto the pedestal.
- Install or remove the TV from the pedestal with at least two people.
- Install or remove the TV by the specified procedure.

Ventilation

Caution

Allow sufficient space around the TV in order to help prevent excessive heat, which could lead to early failure of some electronic components.

Minimum distance:

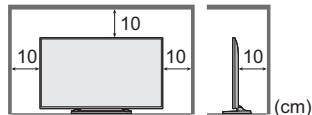

- Ventilation should not be impeded by covering the ventilation openings with items such as newspapers, tablecloths and curtains.



- Whether you are using a pedestal or not, always ensure the vents at the bottom of the TV are not blocked and there is sufficient space to enable adequate ventilation.

■ Moving the TV

Caution

Before moving the TV, disconnect all cables.

- Move the TV with at least two people. Support as shown to avoid injury by the TV tipping or falling.



■ When not in use for a long time

Caution

This TV will still consume some power even in the Off mode, as long as the mains plug is still connected to a live socket outlet.

- Remove the mains plug from the wall socket when the TV is not in use for a prolonged period of time.

■ Excessive volume

Caution

- Do not expose your ears to excessive volume from the headphones. Irreversible damage can be caused.
- If you hear a drumming noise in your ears, turn down the volume or temporarily stop using the headphones.



■ Battery for the Remote Control

Caution

- Incorrect installation may cause battery leakage, corrosion and explosion.
- Replace only with the same or equivalent type.
- Do not mix old and new batteries.
- Do not mix different battery types (such as alkaline and manganese batteries).
- Do not use rechargeable batteries (Ni-Cd, etc.).
- Do not burn or break up batteries.
- Do not expose batteries to excessive heat such as sunshine, fire or the like.
- Make sure you dispose of batteries correctly.
- Remove the battery from the unit when not using for a prolonged period of time to prevent battery leakage, corrosion and explosion.

Accessories

Remote Control

➔ (p. 10)

- N2QAYB000816 or N2QAYB000975



Pedestal

➔ (p. 6)

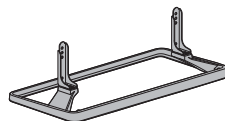

Mains lead

➔ (p. 7)

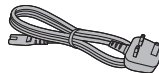

Batteries (2)

- R6

➔ (p. 10)



Operating Instructions

Production Registration Leaflet

- Accessories may not be placed all together. Take care not to throw them away unintentionally.

Assembling / Removing the pedestal

(A) Assembly screw (4)



(B) Assembly screw (4)



(C) Bracket (2)



(D) Base

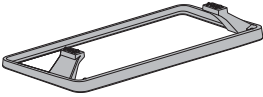

■ Assembling the pedestal

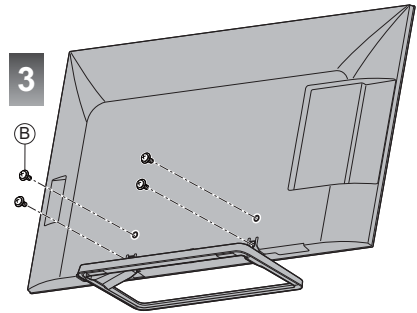
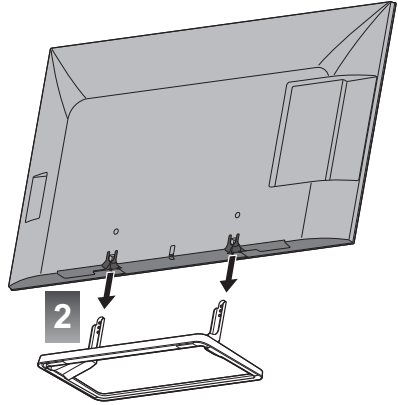
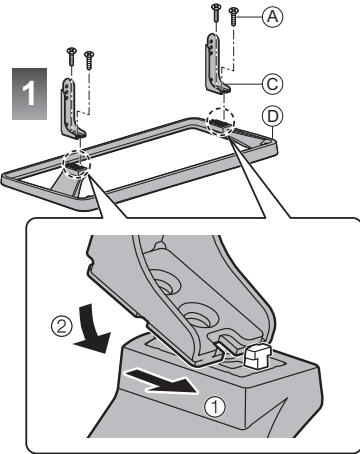

Removing the pedestal from the TV

Be sure to remove the pedestal in the following way when using the wall-hanging bracket or repacking the TV.

1 Remove the assembly screws (B) from the TV.

2 Lift the TV from the pedestal.

3 Remove the assembly screws (A) from the bracket.

Connections

- External equipment and cables shown are not supplied with this TV.
- Please ensure that the unit is disconnected from the mains socket before attaching or disconnecting any cables.
- Check the terminal type and cable plugs are correct when connecting.
- Use a fully wired HDMI compliant cable.
- Use a fully wired SCART cable.
- Keep the TV away from electronic equipment (video equipment, etc.) or equipment with an infrared sensor, otherwise distortion of image / sound may occur or operation of other equipment may be affected.
- Please also read the manual of the equipment being connected.

Terminals

Rear of the TV

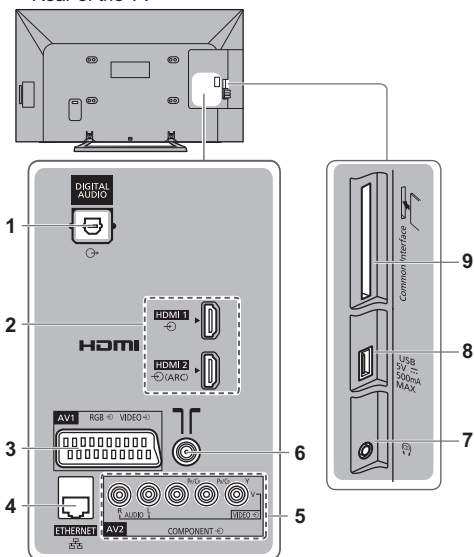

- 1 DIGITAL AUDIO
- 2 HDMI1 - 2 ➔ (p. 8)
- 3 AV1 (SCART) ➔ (p. 7, 8)
- 4 ETHERNET ➔ (p. 9)
- 5 AV2 (COMPONENT / VIDEO) ➔ (p. 8)
- 6 Terrestrial / cable terminal ➔ (p. 7, 8)
- 7 Headphone jack ➔ (p. 8)
- 8 USB port
- 9 CI slot ➔ (p. 9)

Basic connections

■ Mains lead

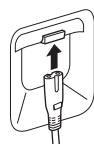
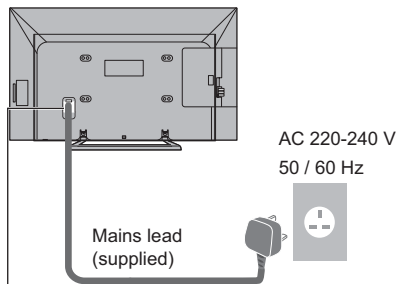

Insert the mains plug firmly into place.

- When disconnecting the mains lead, be absolutely sure to disconnect the mains plug at the socket outlet first.

■ Aerial

TV

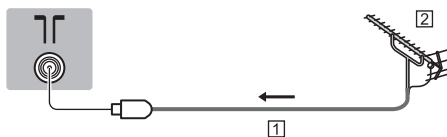

- 1 RF cable
 - 2 Terrestrial aerial
- For DVB-T, Analogue

AV devices

■ DVD Recorder / VCR

TV

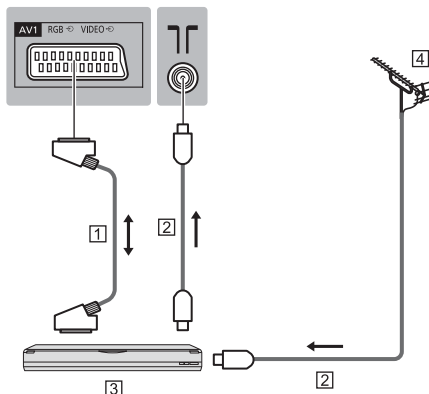

- 1 SCART cable
- 2 RF cable

3 DVD Recorder / VCR

4 Terrestrial aerial

DVD Recorder (VCR) / Set top box

TV

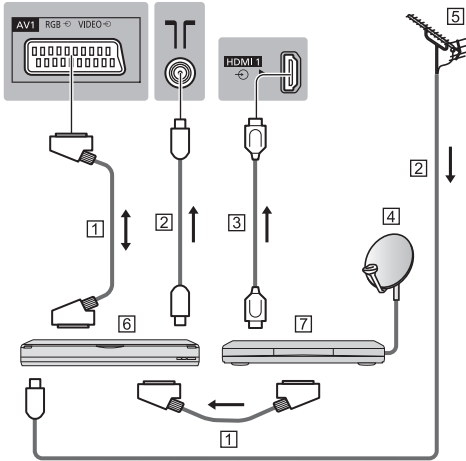

- 1 SCART cable
- 2 RF cable
- 3 HDMI cable
- 4 Satellite dish
- 5 Terrestrial aerial
- 6 DVD Recorder / VCR
- 7 Set top box

Other connections

DVD Player

(COMPONENT equipment)

TV

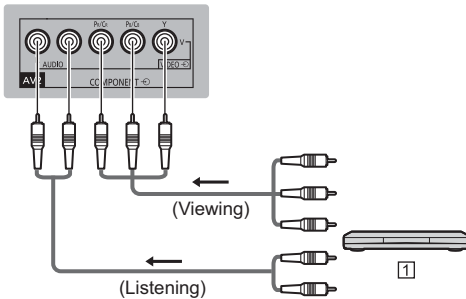

- 1 DVD Player

Camcorder / Game equipment

(VIDEO equipment)

TV

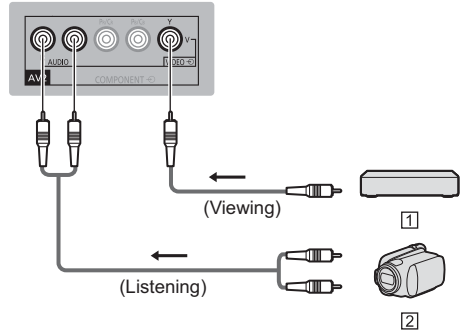

- 1 Game equipment
- 2 Camcorder

Amplifier (to listen with speakers)

- Use HDMI2 for connecting an amplifier. This connection is applicable when using an amplifier that has ARC (Audio Return Channel) function. As for an amplifier without ARC function, use DIGITAL AUDIO.

- To enjoy multi-channel sound from external equipment (e.g. Dolby Digital 5.1ch), connect the equipment to the amplifier. For the connections, read the manuals of the equipment and amplifier.

TV

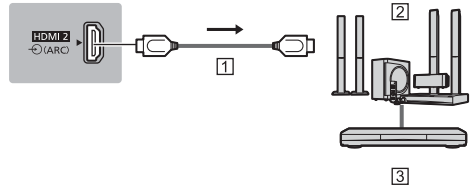

- 1 HDMI cable
- 2 Amplifier with speaker system
- 3 External equipment (DVD Player, etc.)

Headphones

- To adjust volume
 - [Headphone Volume] in the Sound Menu

TV



■ Common Interface

- Turn the TV off with Mains Power On / Off switch whenever inserting or removing the CI module.
- If a smart card and a CI module come as a set, first insert the CI module, then insert the smart card into the CI module.
- Insert or remove the CI module completely in the correct direction as shown.
- Normally encrypted channels will appear. (The viewable channels and its features depend on the CI module.)
If encrypted channels does not appear
➔ **[Common Interface] in the Setup Menu**
- There might be some CI modules in the market with older firmware versions that do not work fully interoperable with this new CI+ v1.3 TV. In this case, please contact your content provider.
- For more information, read the manual of the CI module, or check with the content provider.

TV

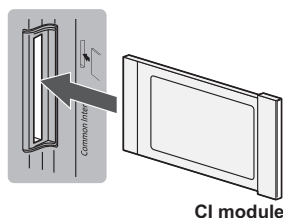

CI module

■ Network connections

Connect the TV and the Broadband network equipment (modem, hub, or router) by using a LAN cable.

- If you do not have a Broadband network services, please consult your retailer for assistance.
- Confirm the term and conditions of the contracts with your Internet Service Provider (ISP) or telecommunications company.
- Set up and connect any equipment required for the network environment.
- Read the manual of the network equipment, too.

TV

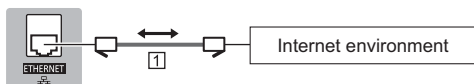

1 LAN cable (Shielded)

- Use the Shielded Twist Pair (STP) LAN cable.

Note

- Depending on the ISP or telecommunications company, the required equipment and the internet connection procedure are different. Ensure that you use the network equipment that are authorized by your ISP and telecommunications company.
- You cannot make settings for the network equipment on this TV. You may be required to make settings on your computer.
- Depending on the terms and conditions of the contracts with your ISP or telecommunications company, additional fees may be charged or multiple connections to the internet may be impossible.
- Please contact your ISP or telecommunications company if you require further assistance regarding the network equipment.

Identifying Controls

Remote Control

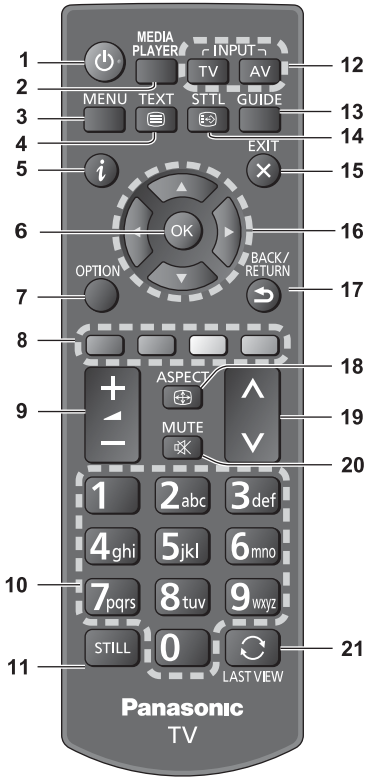

1 Standby On / Off switch

2 MEDIA PLAYER

3 [Main Menu]

- Press to access Picture, Sound, Timer and Setup.

4 Text service button

5 Information

- Displays channel and programme information.

6 OK

- Confirms selections and choices.
- Press after selecting channel positions to quickly change channel.
- Displays channel list.

7 [Option Menu]

- Easy optional setting for viewing, sound, etc.

8 Coloured buttons

(red-green-yellow-blue)

- Used for the selection, navigation and operation of various functions.

9 Volume Up / Down

10 Numeric buttons

- Changes channel and teletext pages.
- Sets characters.
- When in Standby mode, switches TV on.

11 Still

- Freezes / unfreezes the picture.

12 Input mode selection

- TV - switches to DVB / Analogue.
- AV - switches to AV input mode from Input Selection list.

13 TV Guide

- Displays Electronic Programme Guide.

14 Subtitles

- Displays / hides subtitles. (if available)

15 Exit

- Returns to the normal viewing screen.

16 Cursor buttons

- Makes selections and adjustments.

17 Return

- Returns to the previous menu / page.

18 Aspect

- Changes aspect ratio.

19 Channel Up / Down

20 Sound Mute On / Off

21 Last view

- Switches to previously viewed channel or input mode.

■ Installing / Removing batteries

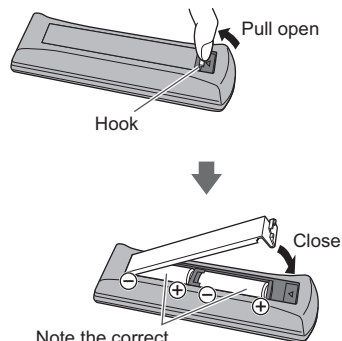

Note the correct polarity (+ or -)

Indicator / Control panel

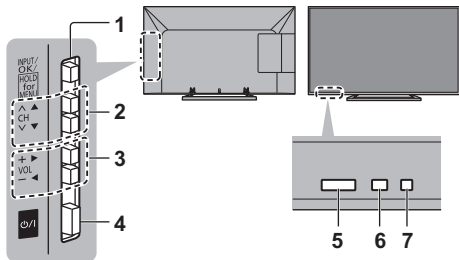

Rear side of the TV

1 Input mode selection

- Press repeatedly until you reach the desired mode.

[Main Menu]

- Press and hold for about 3 seconds to display main menu.

OK (when in the menu system)

2 Channel Up / Down

Cursor Up / Down (when in the menu system)

3 Volume Up / Down

Cursor Left / Right (when in the menu system)

4 Mains power On / Off switch

- Use to switch the mains power.

5 Remote control signal receiver

- Do not place any objects between the TV remote control signal receiver and remote control.

6 Ambient sensor

- Senses brightness to adjust picture quality when [Eco Mode] in the Picture Menu is set to [On].

7 Power LED

Red: Standby

Green: On

- The LED blinks when the TV receives a command from the remote control.

First time Auto Setup

Automatically sets up the TV and searches for available TV channels when the TV is turned on for the first time.

- These steps are not necessary if the setup has been completed by your local dealer.
- Please complete connections (p. 7 - 9) and settings (if necessary) of the connected equipment before starting Auto Setup. For details of settings for the connected equipment, read the manual of the equipment.

1 Plug the TV into mains socket and turn power on



- Takes a few seconds to be displayed.



2 Select the following items

Set up each item by following the on-screen instructions.

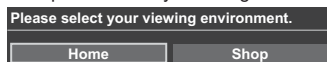

■ How to use remote control



Move the cursor



Access the item / store the setting



Return to the previous item



Exit the item

Select your country

Select [Home]

Select [Home] viewing environment to use in your home environment.

- [Shop] is for shop display.
- To change viewing environment later on, you will need to initialise all settings by accessing Shipping Condition.

Auto Setup is now complete and your TV is ready for viewing.

If tuning has failed, check the connection of the RF cable, and then follow the on-screen instructions.

- To retune all channels
➔ **[Automatic Channel Search]** (p. 21)
- To initialise all settings
➔ **[Shipping Condition]** (p. 21)

Watching TV

1 Turn power on

 (TV)

or

 (Remote Control)

- Mains power On / Off switch should be on. (p. 10)

2 Select the mode



3 Select a channel

 up
 down

or



- To select 2 or more-digit channel position number, e.g. 399



Note

- The TV will automatically go into Standby mode when no operation is performed for the period selected in [Auto Standby] (Timer Menu).

Aspect

Change the aspect ratio (image size)

ASPECT



[Auto]: The best ratio is selected automatically according to the "Aspect Control Signal" (p. 26).

[16:9]: Directly displays the image at 16:9 without distortion (anamorphic).

[14:9]: Displays the image at the standard 14:9 without distortion.

[Just]: Displays a 4:3 image full-screen. Stretching is only noticeable at the left and right edges.

[4:3]: Displays the image at the standard 4:3 without distortion.

[4:3 Full]: Displays a 4:3 image enlarged horizontally to fit the screen.

- For HD (High definition) signals

[Zoom 1]: Displays a 16:9 letterbox or 4:3 image without distortion.

[Zoom 2]: Displays a 16:9 letterbox (anamorphic) image full-screen without distortion.

[Zoom 3]: Displays a 2.35:1 letterbox (anamorphic) image full-screen without distortion. At 16:9, displays the image at its maximum (with slight enlargement).

Note

- Aspect is fixed to [16:9] when [Viewing Mode] is set to [Game] in the Picture Menu.
- Aspect cannot be changed in teletext service.

Information banner

Display Information banner

- Also appears when changing a channel.



Example: DVB

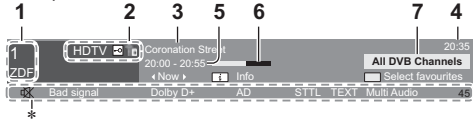

- 1 Channel position and name
- 2 Channel type ([Radio], [Data], [HDTV], etc.) / Encrypted channel () / TV mode
- 3 Programme
- 4 Current time
- 5 Programme Start / Finish time (DVB) Channel number, etc. (Analogue)
- 6 Progress time indicator of the selected programme (DVB)
- 7 [All DVB Channels] or [All Analogue Channels]

*Features available / Message meanings



Sound mute on

[Bad signal]

Poor TV signal quality

[Dolby D+], [Dolby D], [HE-AAC]

Audio track

[Also in HD] (UK only)

Same programme available as HD broadcast

[AD]

Audio Description service available

[STTL]

Subtitle service available

[TEXT]

Text service available

[Multi Audio]

Multiple audio available

[Stereo], [Mono], [NICAM]

Audio mode

1 - 90

Off Timer remaining time

■ To confirm another tuned channel name



■ To watch the channel listed in the banner



■ Information on the next programme (DVB)



■ To hide

EXIT



■ Extra information (DVB)



(Press again to hide the banner)

■ To set display timeout

➔ [Banner Display Timeout] (p. 20)

Note

- [AD], [STTL], [TEXT], [Multi Audio] indications are displayed as available on particular programmes, but may not be available for all individual programmes being broadcast. Display the extra information to confirm availability of these functions.

Viewing Text Service

Teletext services are the text information provided by the broadcasters.

The features may vary depending on the broadcasters.

- The availability of text services for a programme is indicated by [TEXT] in the information banner.

Ireland

Depending on the broadcaster, the digital text (MHEG) services may not be available. In this case, the operation of the text services may be the same as the analogue teletext services.

Digital text (MHEG)

When you switch to a digital text service, the images you see can contain graphics and text, laid out and controlled in a manner decided by the broadcaster.

1 Select DVB







1 Switch to Text service



How to operate services

In all cases, it is possible to navigate the pages using buttons on the remote control, but because the commands available must apply to all manufacturers of digital equipment, some on-screen commands may not correspond exactly to the remote control buttons.

- Select, go  Symbol: ◀▶▶▲
- Back key  Coloured characters  Coloured button
- When options with numbers are displayed 

To exit from Text service



Note

- As soon as you switch to a digital channel with links to a text service, software is downloaded in the background to enable the text function. This means that when switching to a digital channel, you should wait for approximately 5 seconds before pressing the TEXT button - this will allow the software to download. If you press the TEXT button before download is complete, it will be ignored and you

will have to press the TEXT button again when the download is complete.

- While navigating text services, you will find there is a short delay when moving between pages while the page downloads. There is often a prompt shown on the page (for example "Loading") to let you know that this is happening.





Analogue teletext

What is FLOF (FASTTEXT) mode?

In FLOF mode, four differently coloured subjects are situated at the bottom of the screen. To access more information about one of these subjects, press the appropriate coloured button. This facility enables fast access to information on the subjects shown.

What is TOP mode? (in case of TOP text broadcasting)

TOP is a particular improvement of the standard teletext service that enables easier search and effective guide.

- Fast overview of the teletext information available
- Easy to use step-by-step selection of the topical subject
- Page status information at the bottom of the screen
- Available page up / down  (red)  (green)
- To select among subject blocks  (blue)
- To select next subject within the subject block (After the last subject, it moves to the next subject block.)  (yellow)

1 Switch to Teletext

TEXT



- Displays the index page (content varies depending on the broadcasters).

2 Select the page



Coloured buttons (Corresponds to the colour bar)

To return to TV

EXIT



Reveal hidden data

Reveal hidden words e.g. quiz page answers

MENU



- Press again to rehide.

STILL (Hold)

Stop automatic updating

(If you wish to hold the current page without updating)

- Press again to resume.

FULL / TOP / BOTTOM

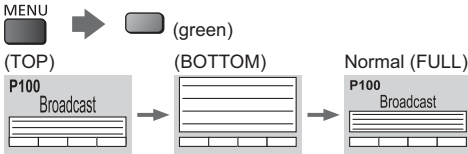

View sub page

View sub page (Only when Teletext is more than one page)



- The number of sub pages varies depending on the broadcasters (up to 79 pages).
- It may take some time for searching, during which time you can watch TV.

■ To view specific sub page



Watch TV while waiting for update

View the TV picture while searching for a teletext page

Teletext automatically updates itself when new information becomes available.



Changes to TV screen temporarily (You cannot change the channel.)



Appears when updating is completed → View the updated page (yellow)

- The news page provides a function that indicates arrival of the latest news ("News Flash").

Using TV Guide

TV Guide - Electronic Programme Guide (EPG) provides an on-screen listing of the programmes currently broadcast and the forthcoming broadcasts over the next seven days (depending on the broadcasters).

- This function varies depending on the country you select.
- DVB-T and Analogue channels are displayed on the same TV Guide screen. There will be no programme listings for Analogue channels.
- When this TV is turned on for the first time, or the TV is switched off for more than a week, it may take some time before TV Guide is completely shown.

1 Select the mode



2 View TV Guide

GUIDE



Example:

The screenshot shows a TV Guide screen for Tuesday, 6-December-2011 13:10:28. It displays a list of programs for channel NDR FS NDS. The interface includes a title bar, a date and time display, and a list of programs with their start and end times. Numbered callouts 1 through 5 point to specific elements: 1 (date and time), 2 (TV Guide date), 3 (TV Guide time), 4 (programme), and 5 (channel position and name).

Time	6:00	6:00	
117 NDR FS NDS	Schleswig-Holst...	bulen un binnen...	Halle Niedersac... Das Beste aus E...
118 NDR FS HH	Schleswig-Holst...	bulen un binnen...	Halle Niedersac... Das Beste aus E...
119 NDR FS SH	Schleswig-Holst...	bulen un binnen...	Halle Niedersac... Das Beste aus E...
120 NDR FS MV	Schleswig-Holst...	bulen un binnen...	Halle Niedersac... Das Beste aus E...
122 MDR Sachsen	Haral...	Rucksack	artour Leben für 4... MDR...
123 MDR S-Anhalt	Haral...	Rucksack	artour Leben für 4... MDR...
124 MDR Thüringen	Haral...	Rucksack	artour Leben für 4... MDR...

- 1 Current date and time
- 2 TV Guide date
- 3 TV Guide time
- 4 Programme
- 5 Channel position and name

- It may cause slow response, when press the UP/ DOWN keys for TV programme guide. This is due to programme data downloading.

■ To view the next programme

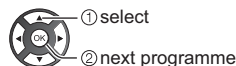

■ To the previous day (DVB)



■ To the next day (DVB)



Watching External Inputs

Connect the external equipment (VCRs, DVD equipment, etc.) and you can watch through the input.

1 Turn the TV on



When connecting with SCART or HDMI

Receives input signals automatically when playback starts.

If input mode is not switched automatically

Perform **2** and **3**

- Check the setup of the equipment.

2 Display the input selection menu



3 Select the input mode connected to the equipment

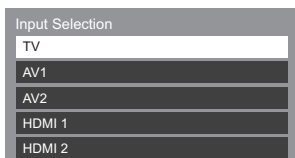

- You can also select the input by pressing the AV button repeatedly.

Using Menu Functions

1 Display the menu

MENU



2 Select the menu



3 Select the item

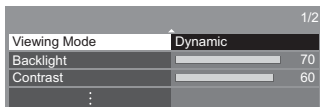

■ Choose from among alternatives

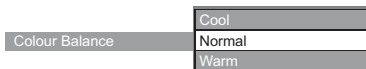

■ Adjust using the slide bar



■ Go to the next screen

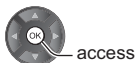

Picture

Viewing Mode

Selects your favourite picture mode for each input.

[Dynamic]: Improves contrast and sharpness for viewing in a bright room.

[Normal]: Normal use for viewing in a normal lighting condition.

[Cinema]: Improves the performance of contrast, black and colour reproduction for watching movies in a darkened room.

[True Cinema]: Reproduces the original image quality precisely without any revision.

[Game]: Provides suitable images for fast response signal when playing games.

- Not valid on TV mode
- To display a continuous record of time spent using [Game] mode ➔ [Playing Time Display] (p. 20)

In each viewing mode, [Contrast], [Brightness], [Colour], [Sharpness], [Tint], [Colour Balance], [P-NR], and [3D-COMB] can be adjusted and stored for each input.

Backlight / Contrast / Brightness / Colour / Sharpness

Adjusts the levels of these options according to your personal preference.

Tint

Adjusts the picture hue to suit your taste.

- For NTSC signal reception

Colour Balance

Sets the overall colour tone of the picture (bluer - redder).

Eco Mode

Automatic Brightness Control function

Adjusts picture settings automatically depending on ambient lighting conditions.

P-NR

Picture Noise Reduction

Reduces unwanted picture noise and flicker noise in the contoured parts of a picture.

3D-COMB

Makes still or slow moving pictures more vivid.

Occasionally, while viewing still or slow moving pictures, colour patterning may be seen. Set to [On] to display sharper and more accurate colours.

- For PAL / NTSC signal reception in TV mode or from composite

Colour Matrix

Selects the suitable colour parameter for SD (Standard definition) or HD (High definition) signal.

- This function is available with 480p or 576p input signal from COMPONENT or HDMI terminal.

AV Colour System

Selects optional colour system based on video signals.

- For AV input

16:9 Overscan

Selects the screen area displaying the image for 16:9 aspect.

[On]: Enlarges the image to hide the edge of the image.

[Off]: Displays the image in the original size.

- Set to [On] if noise occurs on the edge of the screen.
- This function can be memorised for SD (Standard definition) and HD (High definition) signals respectively.

Reset to Defaults

Resets the current Picture Viewing Mode of the selected input to the default settings.

Sound

Mode

Selects your favourite sound mode.

- The selected mode affects all input signals.

[Music]: Improves sound quality for watching music videos, etc.

[Speech]: Improves sound quality for watching news, drama, etc.

[User]: Adjusts the sounds manually by using the equaliser to suit your favourite sound quality.

- For the User mode, [Equaliser] will be available in the Sound Menu instead of [Bass] and [Treble]. Select [Equaliser] and adjust the frequency.
- This function is not effective for the sound from headphones.

Bass

Adjusts level to enhance or minimise lower, deeper sound output.

Treble

Adjusts level to enhance or minimise sharper, higher sound output.

Equaliser

Adjusts the frequency level to suit your favourite sound quality.

- This function is available when [Mode] is set to [User].
- Select the frequency and change the frequency level by using the cursor button.
- To enhance the bass sound, raise the level of the lower frequency. To enhance the treble sound, raise the level of the higher frequency.
- To reset the levels of each frequency to the default settings, select [Reset to Defaults] by using the cursor button.

Balance

Adjusts volume level of right and left speakers.

Headphone Volume

Adjusts the volume of headphones.

Surround

Provides a dynamic enhancer of width to simulate improved spatial effects.

Auto Gain Control

Automatically regulates large sound level differences between channels and inputs.

Volume Correction

Adjusts the volume of each individual channel or input mode.

Speaker Distance to Wall

Compensates for the low frequency sound due to the distance between the speakers and the wall.

- If the back space between the TV and wall is within 30 cm, [Up to 30cm] is recommended.
- If the back space between the TV and wall is over 30 cm, [Over 30cm] is recommended.

Preferred Audio 1 / 2

Selects the first and second preferred language for DVB multi audio (depending on the broadcaster).

MPX

Selects multiplex sound mode. (if available)

[Stereo]: Use this normally.

[Mono]: When stereo signal cannot be received.

[M1] / [M2]: Available while mono signal is transmitted.

- For Analogue mode

SPDIF Selection

SPDIF: A standard audio transfer file format

Selects the initial setting for digital audio output signal from DIGITAL AUDIO and HDMI2 (ARC function) terminals.

[Auto]: Dolby Digital Plus, Dolby Digital and HE-AAC multi-channel are output as Dolby Digital Bitstream. MPEG is output as PCM. DTS is output as DTS for video contents of Media Player.

[PCM]: Digital output signal is fixed to PCM.

- ARC (Audio Return Channel): A function of digital audio output using HDMI cable

MPEG Optical Level

Adjusts the audio level output from DIGITAL AUDIO terminal as the initial setting.

- Normally, [PCM] sound is larger comparing with the other types of audio track.

SPDIF Delay

Adjusts the delay time of the sound output from DIGITAL AUDIO and HDMI2 (ARC function) terminals if the sound does not synchronise the image.

HDMI 1 / 2 Input

Selects to fit the input signal. (p. 26)

[Digital]: When sound is carried via the HDMI cable connection

[Analogue]: When sound is not carried via the HDMI-DVI adaptor cable connection

- For HDMI input

Downmix Mode

Selects the output mode for listening to compressed music.

- For DVB mode

Type

Narration settings for impaired users (only available in some countries).

- [Hearing Impaired] ➔ [Preferred Subtitle Type] (p. 20)
- Set to [Visually Impaired] to activate the narration sound track when available on the broadcast.
- [Visually Impaired] appears after you have selected this option. ➔ (p. 19)
- For DVB mode

Visually Impaired

■ Speaker

Narration sound track is output to the TV speakers.

■ Headphone

Narration sound track is output to the headphone.

- Connect a headphone before selecting this option.

■ Volume

Adjusts the volume of the narration sound track.

■ Pan and Fade

Sets the audio pan and fade effect.

[On]: Controls the level of the Main Audio Programme and controls the pan of the Associated Audio Programme

[Off]: Main Audio programme

Reset to Defaults

Resets the current [Bass], [Treble], [Balance], [Headphone Volume], [Surround], [MPEG Optical Level], [Type], and [Visually Impaired] to the default settings.

Network

Interaction Channel

Interaction channel provides an extension of broadcast interactive services via broadcast transmission or IP connection.

MHEG PIN Protection

Ask the viewer to enter the PIN to allow presentation.

Internet Connection

Set to **[On]** to enable network setting.

Information

Displays information of network connection.

IP Setting

Detect IP automatically or sets IP manually.

Connection Test

Check the TV connects to the network successfully or not.

Timer

Off Timer

Sets the duration of time until the TV automatically goes into Standby mode.

Time Zone

Adjusts the time data.

- The time data will be corrected based on GMT.

Auto Standby

Automatically turns the TV to Standby mode for energy saving when no operation is performed for 4 hours.

[Off] / [2 hours] / [4 hours]

- Automatic input switching with the connected equipment affects this function and time-count will be reset.
- The notification message will appear 3 minutes before going into Standby mode.

Setup

Link Settings

■ CEC

When set to [On], the TV will automatically switch to the appropriate HDMI input whenever an HDMI connected equipment is initially turned on and the Play mode is selected.

- The HDMI CEC feature of connected HDMI CEC-compatible device must be turned on.

■ Power off Link

When set to [On], all HDMI connected equipment will be turned off automatically by turning off the TV.

- A Panasonic DVD Recorder will not turn off if it is still in the Rec mode.
- The TV remains on even if all the HDMI connected equipment are turned off.

Child Lock

Applies access control for channels or inputs to prevent unwanted access. (p. 23)

Tuning Menu

■ Automatic Channel Search

Automatically searches for the receivable channels. (p. 21)

■ Scan

Adds newly found channels while keeping existing channels. (p. 21)

■ Analogue Manual Tuning

Searches for the analogue channels manually. (p. 21)

■ DVB-T Signal Condition

Checks the DVB-T signal condition. (p. 21)

■ DVB-T Manual Tuning

Searches for the DVB-T channels manually. (p. 21)

■ Favourites Edit

Creates a list of favourite channels. (p. 22)

■ Skip

Skips unwanted channels. (p. 22)

■ Sort

Sorts channels. (p. 22)

■ Channel List Edit

Edits channels. (p. 22)

■ Clear block

Clears the channel lists. (p. 22)

Display Settings

■ Preferred Teletext

Selects the preferred language for DVB teletext service. (depending on the broadcaster)

■ Teletext Character Set

Selects teletext language font.

[West]: English, French, German, Greek, Italian, Spanish, Swedish, Turkish, etc.

[East1]: Czech, English, Estonian, Lettish, Rumanian, Russian, Ukrainian, etc.

[East2]: Czech, Hungarian, Lettish, Polish, Rumanian, etc.

■ Preferred Subtitles 1 / 2

Selects the first and second preferred language for DVB subtitles. (depending on the broadcaster)

■ Preferred Subtitle Type

Selects the preferred subtitle type [Hearing Impaired] / [Normal].

- [Hearing Impaired] provides aids in understanding and enjoyment with DVB subtitles (depending on the broadcaster).
- [Preferred Subtitles 1] / [Preferred Subtitles 2] are given priority.

■ Input Labels

Accesses the input labels list to select the label of each input mode or set to skip unconnected one for easier identification and selection in [TV Selection] (p. 12), [Input Selection] (p. 16) or banner.

- To skip the input mode, select [Skip].

■ Banner Display Timeout

Sets how long the Information banner stays on screen.

■ Playing Time Display

Sets to [On] to display a continuous record of time spent using [Game] mode in the top right of the screen every 30 minutes.

- This function is available when [Viewing Mode] is set to [Game]. ➔ (p. 17)

■ Radio Mode

Sets the timer for turning off the screen automatically when a radio channel is selected.

The sound is active even if the screen turns off. This function is effective in reducing power consumption when listening to a radio channel.

- Press any buttons except Standby, Volume Up / Down and MUTE buttons to turn the screen on.
- Not valid on Analogue mode

System Menu

■ Shipping Condition

Resets all settings to the original condition.

■ Common Interface

Sets to watch encrypted channels, etc. (p. 12)

■ System Update

Downloads new software to this TV. (p. 23)

■ Software License

Displays the software licence information.

■ System Information

Displays the system information of this TV.

Power Save

Reduces brightness of the picture to economise on power consumption.

Note

- A different menu will be displayed in the mode of Media Player. (p. 24)
- Only available items can be selected.

Tuning and Editing Channels

You can retune channels or make your favourite channel lists, skip unwanted channels, etc.

MENU → [Setup] → [Tuning Menu]*

*The menu name varies depending on the TV mode.

- The settings in [Tuning Menu] are applicable only for the selected TV mode.

Retuning channels

- Only the selected mode is retuned. All the previous tuning settings are erased.

Select [Automatic Channel Search]



Manual Tuning

■ Analogue Manual Tuning (Ireland)

Set Analogue channel manually after [Automatic Channel Search].

1 Enter the frequency to start scanning

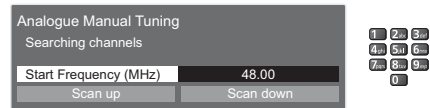

2 Select the scanning method

[Scan up]: Scans ascendingly from the entered frequency to higher frequencies.

[Scan down]: Scans descendingly from the entered frequency to lower frequencies.

■ DVB Manual Tuning

Normally use [Automatic Channel Search] or [Scan] to retune DVB channels.

If tuning has not been done completely or for adjusting the direction of the aerial, use this function.

- All channels found will be added to the [Channel List].

DVB-T

Select channel and start scan

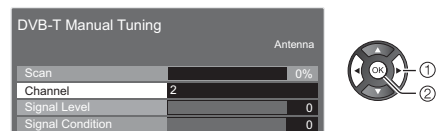

Check DVB signal condition

DVB-T Signal Condition	
Channel	22
Signal Level	0
Signal Condition	0
Bit Error Rate	0.00E-06

These bars show the maximum signal value of the selected channel.

Editing channels

Favourites Edit

Create your favourite channel lists from various broadcasters.

Select a channel to list

Favourites Edit	
1	Analogue BBC ONE Wales
2	Analogue BBC THREE
3	Digital BBCi
4	Digital CBBC Channel



✓ : [Add]

● : [Remove]

Skip

You can hide (skip) unwanted channels.

The hidden channels cannot be displayed except in this function.

Select a channel and reveal / hide

Skip	
1	Analogue BBC ONE Wales
2	Analogue BBC THREE
3	Digital BBCi
4	Digital CBBC Channel



✓ : Hide (skip)

● : Reveal

Sort

You can sort channels.

1 To swap the channel position (if available)

Sort	
1	Analogue BBC ONE Wales
2	Analogue BBC THREE
3	Digital BBCi
4	Digital CBBC Channel



✓ : selected

● : unselected

2 Swap



- To change page (page up)
 - (red)
- To change page (page down)
 - (green)
- To select
 - (yellow)
- To exit
 - (blue)

Editing channel settings

Channel List Edit

You can edit channel settings.

1 Select a channel to edit

Channel List Edit	
1	Analogue BBC ONE Wales
2	Analogue BBC THREE
3	Digital BBCi
4	Digital CBBC Channel



2 Edit the channel settings

- You cannot change [Network Name].
- [Frequency (MHz)], [Colour System] and [Sound System] edit is valid for analogue channels only.
- You can set characters by using numeric buttons. (When you select [Channel Name]).

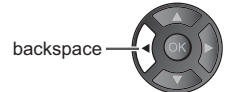

Child Lock

You can lock specific channels / AV input terminals and control who watches them.

When the locked channel / input is selected, a message appears. Enter the PIN number to watch.

MENU  → [Setup] → [Child Lock]

- 1 Enter the PIN number (4 digits)
 - Enter the PIN number twice at first setting.
 - Make a note of the PIN number in case you forget it.
 - "0000" may be stored as the default PIN number which depends on the country you select.

- 2 Select [Child Lock List] and set the channel / input to be locked

Name	Input	Type	Lock
101 BBC1 Wales	DVB	Free TV	
7 BBC THREE	DVB	Free TV	
14 E4C	DVB	Free TV	
VCR	Analogue	Analogue	
1 BBC1	Analogue	Analogue	
2 ****	Analogue	Analogue	
AV1	External	AV	
AV2	External	AV	



: Appears when the channel / input is locked

To edit the list by using the coloured buttons

- **Lock all:** Locks all channels and input.
- **Unlock all:** Cancels all locks.
- **To change the PIN number**

Select [Change PIN] and enter a new PIN number twice

■ To set Parental Rating

To watch the DVB programme that has the rating information over the selected age, enter the PIN number to watch (depending on the broadcaster).

Select [Parental Rating] and set an age for the restriction of programmes.

Note

- Setting [Shipping Condition] (p. 21) erases the PIN number and all settings.

Updating the TV Software

A new version of software may be released for download to enhance the performance or operations of the TV.

- Download may take a few hours.
- During software download and update, DO NOT switch off the TV.

Update from Broadcasting

If there is an update available, a notification message is displayed when the channel has the update information.

- To update in next Standby mode, select [Standby].
To update immediately, select [Now].
(Select [Ignore] not to update.)

You can search new software automatically or update manually.

MENU  → [Setup] → [System Menu] → [System Update]

■ To update automatically

Set [Auto Download] and [Auto Install] to [Yes]

Manual OAD Download	Access
Auto Download	Yes
Auto Install	No

If System Update is performed, the software will be updated (it may change TV functions).

If you do not want to do so, set [Auto Install] to [No].

- Every time you set, the TV automatically performs a search in Standby and downloads an update, if any software updates are available.
- The automatic updating is performed in Standby mode (TV turned off with the remote control).

■ To update immediately

- 1 Select [Manual OAD Download]
- 2 Searches for an update (for several minutes) and displays a corresponding message if any

- 3 Download



Note

- Download may take a few hours.
- During software download and update, DO NOT switch off the TV.
- The notification message might be a reminder. In this case, the schedule information (the date that the new version can be used) will appear. You can set the reservation for update. The update will not start when the TV is off.

Using Media Player

Media Player allows you to enjoy photo, video or music recorded on a USB Flash Memory.

Photo mode:

Digital photo data will be displayed.

Music mode:

Digital music data will be played back.

Movie mode:

Digital video data will be played back.

- Supported file format ➔ **“Supported file format in Media Player” (p. 26)**
- During the operation, audio signal is output from AV1, DIGITAL AUDIO and HDMI2 (ARC function) terminals. But no video signals are output. To use HDMI2 with ARC function, connect an amplifier that has ARC function.
- The picture may not appear correctly on this TV depending on the recording equipment used.
- Display may take some time when there are many files and folders.
- Partly degraded files might be displayed at a reduced resolution.
- Picture setting may not work depending on the conditions.
- The folder and file names may be different depending on the digital camera or digital video camera used.

■ To insert or remove the USB Flash Memory

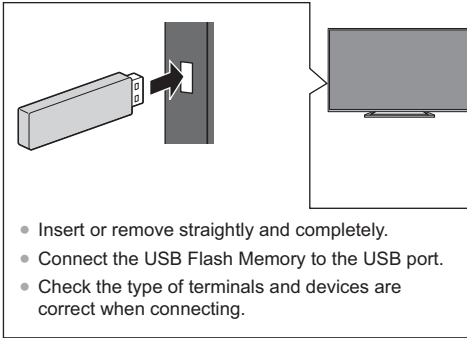

- Insert or remove straightly and completely.
- Connect the USB Flash Memory to the USB port.
- Check the type of terminals and devices are correct when connecting.

1 Insert the USB Flash Memory to the TV

2 Start [Media Player] and select the content (Photo / Music / Movie)



- Select the appropriate content for playing back each file.

■ To change the contents

While the thumbnail is displayed, display the contents selection

(blue)

Photo mode

Example: Thumbnail - [All photos]



: Error display

[Single view] - Photos are displayed one at a time. **Select the file from the thumbnail of photos to be viewed**

[Slideshow] - Slideshow completes when all photos are viewed within the current thumbnail.

1 Select the file from the thumbnail of photos for the first view

2 Start Slideshow

(red)

- To display / hide the operation guide



■ To sort by folder

1 Display the view selection in the thumbnail view

(green)

2 Select [Folder view]

Displays the thumbnail grouped by folder.

Photo Settings

OPTION

➔ [Slideshow Settings]

■ Transition Effect

Selects the transition effect for switching the photo during the slideshow.

■ Screen Mode

Selects enlarged or normal viewing on Single view and Slideshow.

- Depending on the photo size, it may not be fully enlarged to fill the screen, e.g. portrait style picture.

■ Interval

Selects slideshow interval.

■ Repeat

Slideshow repeat

■ Back Ground Music

Selects the back ground music during Photo mode.

- [Type1 - 3] are the fixed music each installed in this TV.

Note

- Picture quality may become lower depending on the slideshow settings.
- Picture setting may not work depending on the slideshow settings.

Music mode

Example: Thumbnail - [Folder view]

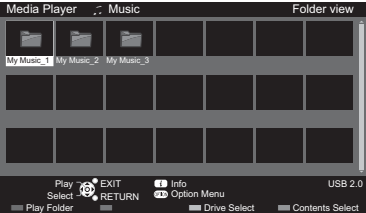

- 1 Select the folder / file
- 2 Start playback

 (red)

- To display / hide the operation guide



Music Setup

OPTION  [Music Setup]

Repeat

[Folder]: Playback repeat within the selected folder

[One]: Playback repeat of the selected one file

Movie mode

Example: Thumbnail - [Title view]

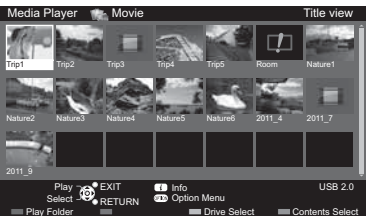

 : Error display

 : The file does not support thumbnail view.

- 1 Select the title / scene
- 2 Start playback

 (red)

- To display / hide the operation guide and information banner



- To change aspect

ASPECT



Video Setup

OPTION  Video Setup Menu

Repeat

Playback repeat within the selected file (depending on the content).

Technical Information

Aspect Control Signal

Programmes usually contain an "Aspect Control Signal" (Widescreen signal, Control signal through SCART / HDMI terminal).

In [Auto] mode, aspect mode will appear in the top left of the screen if a Widescreen signal (WSS) or a Control signal through SCART (pin8) / HDMI terminal is found. The aspect will switch to the appropriate ratio.

Available conditions for the Widescreen signal (WSS)

Input terminal	Input signal format
Terrestrial	DVB
	PAL I
AV1 / AV2 (Composite)	PAL
AV2 (Component)	625 (576) / 50i, 50p

Note

- If the screen size looks unusual when a widescreen-recorded programme is played back on a VCR, adjust the tracking of the VCR.

HDMI connection

This TV incorporates HDMI™ technology. HDMI (high-definition multimedia interface) allows you to enjoy high-definition digital images and high-quality sound by connecting the TV and the equipment.

HDMI-compatible equipment*¹ with an HDMI or DVI output terminal, such as a DVD player, a set top box or game equipment, can be connected to the HDMI terminal using an HDMI compliant (fully wired) cable.

Applicable HDMI features

- Input audio signal: 2ch Linear PCM (sampling frequencies - 48 kHz, 44.1 kHz, 32 kHz)
- Input video signal ➔ **"Input signal that can be displayed" (p. 26)**

Match the output setting of the digital equipment.

- Content Type
- Audio Return Channel*² (HDMI2 terminal only)

DVI connection

If the external equipment has only a DVI output, connect to the HDMI terminal via a DVI to HDMI adaptor cable. When the DVI to HDMI adaptor cable is used, connect the audio cable to AV2 audio terminals.

Note

- Audio settings can be made on [HDMI Input] in the Sound Menu. (p. 18)
- If the connected equipment has an aspect adjustment function, set the aspect ratio to "16:9".
- These HDMI connectors are compatible with HDCP (High-Bandwidth Digital Content Protection) copyright protection.
- Equipment having no digital output terminal may be connected to the input terminal of component or video to receive analogue signals.

*1: The HDMI logo is displayed on HDMI-compliant equipment.

*2: Audio Return Channel (ARC) is a function to send digital sound signals via an HDMI cable.

Input signal that can be displayed

COMPONENT (AV2) / HDMI terminal

Signal name	COMPONENT	HDMI
525 (480) / 60i, 60p	○	○
625 (576) / 50i, 50p	○	○
750 (720) / 60p, 50p	○	○
1,125 (1,080) / 60i, 50i	○	○
1,125 (1,080) / 60p, 50p, 24p		○

- : Applicable input signal
- Signals other than above may not be displayed properly.
- The above signals are reformatted for optimal viewing on your display.

Supported file format in Media Player

- Some files may not be played back even if they fulfil these conditions.
- Do not use two-byte characters or other special codes for file names.
- Connected devices may become unusable with this TV if the file or folder names are changed.

Photo

JPEG (.jpg / .jpeg)

Image resolution (pixel): 8 × 8 to 30,719 × 17,279

Sub-sampling: 4:4:4, 4:2:2, 4:2:0

- DCF and EXIF standards
- Progressive JPEG is not supported.

Video

■ AVI (.avi)

Video codec: H.264 BP/MP/HP, MPEG1, MPEG2, MPEG4 SP/ASP, VC-1, Windows Media Video Ver. 9

Audio codec: AAC, Dolby Digital, Dolby Digital Plus, DTS core, HE-AAC, LPCM, MPEG Audio, MP3, WMA

- Some subtitles or chapter functions may not be available.
- WMA Pro and WMA Lossless are not supported.

■ MKV (.mkv)

Video codec: H.264 BP/MP/HP, MPEG1, MPEG2, MPEG4 SP/ASP

Audio codec: AAC, Dolby Digital, Dolby Digital Plus, DTS core, HE-AAC, MPEG Audio, MP3

- Some subtitles or chapter functions may not be available.

■ ASF (.asf / .wmv)

Video codec: MPEG4 SP/ASP, VC-1, Windows Media Video Ver. 9

Audio codec: AAC, Dolby Digital, Dolby Digital Plus, HE-AAC, LPCM, MP3, WMA

- Copy-protected files cannot be played back.
- WMA Pro and WMA Lossless are not supported.

■ MP4 (.f4v / .m4v / .mp4)

Video codec: H.264 BP/MP/HP, MPEG1, MPEG2, MPEG4 SP/ASP

Audio codec: AAC, Dolby Digital, Dolby Digital Plus, HE-AAC, MPEG Audio, MP3

- This TV supports this container recorded with Panasonic products. For details, read the manual of the products.

■ FLV (.flv)

Video codec: H.264 BP/MP/HP

Audio codec: AAC, MP3

■ 3GPP (.3gp / .3g2)

Video codec: H.264 BP/MP/HP, MPEG4 SP/ASP

Audio codec: AAC, HE-AAC

■ PS (.mod / .mpg / .mpeg / .vob / .vro)

Video codec: H.264 BP/MP/HP, MPEG1, MPEG2, VC-1

Audio codec: AAC, Dolby Digital, Dolby Digital Plus, HE-AAC, LPCM, MPEG Audio, MP3

■ TS (.mts / .m2ts / .tp / .trp / .ts / .tts)

Video codec: H.264 BP/MP/HP, MPEG1, MPEG2, VC-1

Audio codec: AAC, Dolby Digital, Dolby Digital Plus, DTS core, HE-AAC, MPEG Audio, MP3

Subtitles

■ MicroDVD, SubRip, Tmplayer (.srt / .sub / .txt)

- The video file and subtitles text file are inside the same folder, and the file names are the same except for the file extensions.
- If there are more than one subtitles text files inside the same folder, they are displayed in the following order of priority: ".srt", ".sub", ".txt".

Music

■ MP3 (.mp3)

■ AAC (.m4a)

- Copy-protected files cannot be played back.

■ WMA (.wma)

- Copy-protected files cannot be played back.
- WMA Pro and WMA Lossless are not supported.

■ LPCM (.wav)

■ FLAC (.flac)

Devices for playing back

■ USB Flash Memory (for playing back in [Media Player])

- USB Flash Memory format: FAT16, FAT32, NTFS
- USB Flash Memory compliance: Supports only USB1.1 or USB2.0 standard Maximum USB capacity supported is 32GB USB Hub or card adapter is not supported

Note

- Data modified with a PC may not be displayed
- Do not remove the device while the TV is accessing data. Otherwise this can damage device or TV.
- Do not touch the pins on the device.
- Do not subject the device to a high pressure or impact.
- Insert the device in the correct direction. Otherwise this can damage device or TV.
- Electrical interference, static electricity, or erroneous operation may damage the data or device.
- Back up the recorded data at regular intervals in case of deteriorated or damaged data or erratic operation of the TV. Panasonic is not liable for any deterioration or damage of recorded data.

USB connection

- It is recommended to connect the USB Flash Memory directly to the TV's USB port.
- Some USB devices or USB HUB may not be used with this TV.
- You cannot connect any devices by using USB card reader.
- Additional information for USB devices may be on the following website.
<http://panasonic.net/viera/support>

FAQs

Before requesting service or assistance, please follow these simple guides to solve the problem. When an error message appears, follow the message's instructions. If the problem still persists, contact your local Panasonic dealer or the authorised service centre.

Block noise, frozen or disappearing image occurs in DVB mode / White spots or shadow image (ghosting) occurs in Analogue mode / Some channels cannot be tuned

- Check the position, direction and connection of the aerial.
 - Check [DVB-T Signal Condition] (p. 20). If [Signal Condition] is poor, check aerial.
 - Weather conditions will affect signal reception (heavy rain, snow, etc.), in particular in poor reception areas. Even during good weather, the high pressure can cause poor reception of some channels.
 - Due to the digital reception technologies involved, quality of the digital signals may be relatively low in some cases, despite good reception of analogue channels.
 - Consult your local dealer or service provider for the availability of services.
-

Picture quality problem

- Check the settings of the Picture Menu.
 - Set [P-NR] to remove noise (p. 17).
 - Check nearby electrical products (car, motorcycle, fluorescent lamp).
 - Reset channels.
 - Check that the output of the external equipment matches the input of the TV. When connecting with SCART, ensure the output setting of the external equipment is not S-Video.
-

Sound quality problem

- Check the volume level or sound mute.
 - Check connections and setting of external equipment.
 - Sound signal reception may be deteriorated.
 - Set [MPX] to [Mono] (p. 18).
-

Picture or sound problems with HDMI connection

- Check the HDMI cable is connected properly.
 - Turn the TV and equipment off, then turn them on again.
 - Check an input signal from the equipment.
 - Use equipment compliant with EIA/CEA-861/861D.
 - Set the sound setting of the connected equipment to "2ch L.PCM".
 - Check the [HDMI 1 / HDMI 2] setting (p. 19).
 - If digital sound connection has a problem, select analogue sound connection.
-

The TV does not switch on

- Check the mains lead is plugged into the TV and the socket outlet.
 - The fuse in the mains plug may have blown. Replace it with one of an identical rating. ➔ (p. 3)
-

The TV goes into Standby mode

- Auto power standby function is activated.
-

The remote control does not work or is intermittent

- Are the batteries installed correctly? ➔ (p. 10)
 - Has the TV been switched on?
 - The batteries may be running low. Replace them with new ones.
 - Point the remote control directly at the TV's remote control signal receiver (within about 7 m and a 30 degree angle of the signal receiver).
 - Situate the TV away from sunshine or other sources of bright light not to shine on the TV's remote control signal receiver.
-

No image can be displayed

- Check the TV is turned on.
 - Check the mains lead is plugged into the TV and the socket outlet.
 - Check the correct input mode is selected.
 - Check the settings of the Picture Menu.
 - Check all required cables and connections are firmly in place.
-

Unusual image is displayed

- Turn the TV off with Mains power On / Off switch, then turn it on again.
 - If the problem persists, initialise all settings.
➔ [Shipping Condition] (p. 21)
-

There may be red, blue, green and black spots on the screen

- This is a characteristic of liquid crystal panels and is not a problem. The liquid crystal panel is built with very high precision technology giving you fine picture details. Occasionally, a few non-active pixels may appear on the screen as a fixed point of red, green, blue or black. Please note this does not affect the performance of your LCD.
-

Parts of the TV become hot

- Even if the temperature of parts of the front, top and rear panels has risen, these temperature rises do not cause any problems in terms of performance or quality.
-

The LCD panel moves slightly and clattered sound is heard when it is pushed with a finger

- There is a little gap around the panel to prevent damage to the panel. This is not a malfunction.

Overcurrent error message appears

- The connected USB device might cause this error. Remove the device and turn the TV to standby mode with Standby On / Off switch, then turn it on again.
- Check foreign objects are not inside the USB port.

Check you can get Freeview HD in your area. Text your postcode, followed by your house number or name to **80560***. Or visit **freeview.co.uk**

*e.g. NW96NY1 (Costs no more than a normal text.)

To get the most up to date service from Freeview it is important for Freeview customers to retune from time to time.

How do I re-tune my Freeview TV ?

This is a quick reference. If you have any problems, check the Operating Instructions or ask a friend or family member to show you how. Alternatively, go to your local electrical retailer, contact your local Panasonic dealer or visit **freeview.co.uk/retune**

Re-tuning only takes a few minutes, just follow the steps below:

1. Press the TV button to select DVB mode.
2. Press the MENU button to open the main menu.
3. [Setup] ➔ [DVB-T Tuning Menu] ➔ [Auto Setup]

Please note: most digital TV recorders will keep your original recordings after running a re-tune but you will need to reset any future recordings.

Maintenance

First, remove the mains plug from the socket outlet.

Display panel, Cabinet, Pedestal

Regular care:

Gently wipe the surface of the display panel, cabinet, or pedestal by using a soft cloth to clean the dirt or fingerprints.

For stubborn dirt:

- (1) First clean the dust on the surface.
- (2) Dampen a soft cloth with clean water or diluted neutral detergent (1 part detergent to 100 parts water).
- (3) Wring the cloth firmly. (Please note liquids do not enter the TV inside. May lead to product failure.)
- (4) Finally, wipe away all the moisture.

Caution

- Do not use a hard cloth or rub the surface too hard, otherwise this may cause scratches on the surface.
- Take care not to subject the surfaces to insect repellent, solvent, thinner or other volatile substances. This may degrade surface quality or cause peeling of the paint.
- The surface of the display panel is specially treated and may be easily damaged. Take care not to tap or scratch the surface with your fingernail or other hard objects.
- Do not allow the cabinet and pedestal to make contact with a rubber or PVC substance for a long time. This may degrade surface quality.

Mains plug

Wipe the mains plug with a dry cloth at regular intervals. Moisture and dust may cause fire or electrical shock.

Specifications

■ TV

Model Name

39-inch model : TX-39A400B

42-inch model : TX-42A400B

50-inch model : TX-50A400B

Dimensions (W × H × D)

39-inch model

886 mm × 560 mm × 247 mm (With Pedestal)

886 mm × 516 mm × 53 mm (TV only)

42-inch model

963 mm × 610 mm × 247 mm (With Pedestal)

963 mm × 566 mm × 69 mm (TV only)

50-inch model

1 126 mm × 697 mm × 260 mm (With Pedestal)

1 126 mm × 652 mm × 53 mm (TV only)

Mass

39-inch model

11.0 kg Net (With Pedestal)

10.0 kg Net (TV only)

42-inch model

10.5 kg Net (With Pedestal)

9.0 kg Net (TV only)

50-inch model

16.0 kg Net (With Pedestal)

15.0 kg Net (TV only)

Power source

AC 220-240 V, 50 / 60 Hz

Panel

LED LCD panel

Sound

Speaker output

20 W (10 W + 10 W)

Headphones

M3 (3.5 mm) stereo mini Jack × 1

Connection terminals

AV1 input / output

SCART (Audio/Video in, Audio/Video out, RGB in)

AV2 input (COMPONENT / VIDEO)

VIDEO

RCA PIN Type × 1

1.0 V[p-p] (75 Ω)

AUDIO L - R

RCA PIN Type × 2

0.5 V[rms]

Y

1.0 V[p-p] (including synchronisation)

P_B, P_R

±0.35 V[p-p]

HDMI 1 / 2 input

TYPE A Connectors

HDMI1: Content Type

HDMI2: Content Type, Audio Return Channel

Card slot

Common Interface slot (complies with CI Plus) × 1

ETHERNET

RJ45, IEEE802.3 10BASE-T / 100BASE-TX

USB

USB2.0 DC 5 V, Max. 500 mA

DIGITAL AUDIO output

PCM / Dolby Digital / DTS, Fibre optic

Receiving systems / Band name

Check the latest information on the available services at the following website.

<http://panasonic.net/viera/support>

DVB-T / T2

Digital terrestrial services

UK

PAL I

UHF E21 -68

Ireland

PAL I

VHF A -J

CATV S1 -S20

UHF E21 -E69

CATV S21 -S41 (Hyperband)

PAL 525/60

Playback of NTSC tape from some PAL Video recorders (VCR) or NTSC disc playback from DVD player and recorder

M.NTSC

Playback from M.NTSC Video recorders (VCR)

NTSC (AV input only)

Playback from NTSC Video recorders (VCR)

Aerial input

UK

UHF

Ireland

VHF / UHF

Operating conditions

Temperature: 0 °C - 35 °C

Humidity: 20 % - 80 % RH (non-condensing)

Note

- Design and Specifications are subject to change without notice. Mass and Dimensions shown are approximate.
- For the information of power consumption, display resolution, etc., please refer to Product fiche.
- This equipment complies with the EMC standards listed below.

EN55013, EN61000-3-2, EN61000-3-3, EN55020

■ When using the wall-hanging bracket

- Please contact your local Panasonic dealer to purchase the recommended wall-hanging bracket.
- Holes for wall-hanging bracket installation

Rear of the TV

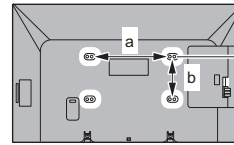

39-inch model

42-inch model

a: 200 mm

b: 200 mm

50-inch model

a: 400 mm

b: 200 mm

(View from the side)

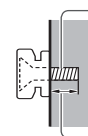

Screw for fixing the TV onto the wall-hanging bracket (not supplied with the TV)

Depth of screw

39-inch model

minimum: 11 mm

maximum: 27 mm

42-inch model

minimum: 10 mm

maximum: 19 mm

50-inch model

minimum: 10 mm

maximum: 28 mm

Diameter: M6

Warning

- Using other wall-hanging brackets, or installing a wall-hanging bracket by yourself have the risk of personal injury and product damage. In order to maintain the unit's performance and safety, be absolutely sure to ask your dealer or a licensed contractor to secure the wall-hanging brackets. Any damage caused by installing without a qualified installer will void your warranty.
- Carefully read the instructions accompanying the wall-hanging bracket, and be absolutely sure to take steps to prevent the TV from falling off.
- Handle the TV carefully during installation since subjecting it to impact or other forces may cause product damage.
- Do not mount the unit directly below ceiling lights (such as spotlights or halogen lights) which typically give off high heat. Doing so may warp or damage plastic cabinet parts.
- Take care when fixing wall brackets to the wall. Always ensure that there are no electrical cables or pipes in the wall before hanging bracket.
- To prevent fall and injury, remove the TV from its fixed wall position when it is no longer in use.

Information for Users on Collection and Disposal of Old Equipment and used Batteries



These symbols on the products, packaging, and/or accompanying documents mean that used electrical and electronic products and batteries should not be mixed with general household waste. For proper treatment, recovery and recycling of old products and used batteries, please take them to applicable collection points, in accordance with your national legislation and the Directives 2002/96/EC and 2006/66/EC.

By disposing of these products and batteries correctly, you will help to save valuable resources and prevent any potential negative effects on human health and the environment which could otherwise arise from inappropriate waste handling.



For more information about collection and recycling of old products and batteries, please contact your local municipality, your waste disposal service or the point of sale where you purchased the items.

Penalties may be applicable for incorrect disposal of this waste, in accordance with national legislation.

For business users in the European Union

If you wish to discard electrical and electronic equipment, please contact your dealer or supplier for further information.

[Information on Disposal in other Countries outside the European Union]

These symbols are only valid in the European Union. If you wish to discard these items, please contact your local authorities or dealer and ask for the correct method of disposal.

Note for the battery symbol (bottom two symbol examples):

This symbol might be used in combination with a chemical symbol. In this case it complies with the requirement set by the Directive for the chemical involved.



Cd

Sales and Support Information

Customer Communications Centre

- For customers within the UK: **0844 844 3899**
- For customers within Ireland: **01289 8333**
- Monday – Friday 9:00am – 5:00pm, (Excluding public holidays).
- For further support on your product, please visit our website: www.panasonic.co.uk

Direct Sales at Panasonic UK

- Order accessory and consumable items for your product with ease and confidence by phoning our Customer Communications Centre Monday – Friday 9:00am – 5:00pm, (Excluding public holidays).
- Or go on line through our Internet Accessory ordering application at www.pas-europe.com.
- Most major credit and debit cards accepted.
- All enquiries transactions and distribution facilities are provided directly by Panasonic UK.
- It couldn't be simpler!
- Also available through our Internet is direct shopping for a wide range of finished products. Take a browse on our website for further details.



Authorized Representative:
Panasonic Testing Centre
Panasonic Marketing Europe GmbH
Winsbergring 15, 22525 Hamburg, Germany

Customer's Record

The model number and serial number of this product may be found on its rear panel. You should note this serial number in the space provided below and retain this book, plus your purchase receipt, as a permanent record of your purchase to aid in identification in the event of theft or loss, and for Warranty Service purposes.

Model Number

Serial Number

Panasonic UK, a branch of Panasonic Marketing Europe GmbH

Willoughby Road, Bracknell, Berkshire, RG12 8FP

Web Site: <http://panasonic.net>

English