

Panasonic®

Owner's Manual for advanced features Digital Camera

Model No. **DMC-FZ70**

LUMIX

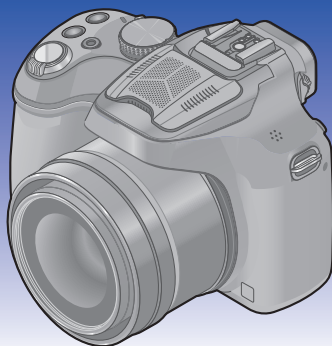

Please read these instructions carefully before using this product, and save this manual for future use.



Register online at
www.panasonic.com/register
(U.S. customers only)

VQT5B76
M0713KZ0

Contents

Preparations

Before use	7
Standard Accessories	9
Names and Functions of Main Parts ... 10	
Viewfinder	13
Cursor button / [MENU/SET] button.....	14
Rear Dial	14
Attaching the Lens Cap/	
Shoulder Strap	15
Attaching the Lens Cap.....	15
Attaching the Shoulder Strap	16
Charging battery	17
Remaining battery.....	18
Guidelines for number of recordable pictures and operating time.....	19
Inserting and Removing the Card (optional)/the Battery	21
About the Built-in Memory/the Card ... 23	
Recording capacity guidelines (pictures/recording time)	24
Setting the clock	26
To change time setting	27
Tips for taking good pictures	28
Preventing jitter (camera shake)	28

Basics

Sequence of operations	29
Taking pictures with your own settings	
[Program AE] Mode	32
Program Shift	33
How to adjust focus	35
Taking pictures with automatic settings	
[Intelligent Auto] Mode	36
Automatic Scene Detection.....	37
Defocusing the background	38
About flash	39
About [Intelligent Auto] setting items	39
[Color Mode].....	39
[Motion Deblur].....	40
[iHandheld Nite Shot]	40
[iHDR].....	41
AF Tracking	42
[Intelligent Auto Plus] Mode.....	43
Recording motion pictures	45
Recording still pictures while a motion picture is being recorded.....	48
Viewing your pictures ([Normal Play])	49
Zooming in and viewing "Playback Zoom"	50
Viewing a list of pictures "Multi Playback".....	51
Viewing pictures by their recording date [Calendar].....	52
Viewing motion pictures	53
Capturing still pictures from motion pictures.....	54
Deleting pictures	55
To delete multiple (up to 50) To delete all pictures	56
Setting the menu	57
Setting menu items	57
Using Quick menu	60

Using the [Setup] menu	61
[Clock Set].....	61
[World Time].....	61
[Travel Date].....	61
[Beep].....	61
[Speaker Volume].....	61
[Cust.Set Mem.].....	62
[AF/AE LOCK / Fn1].....	62
[Fn Button Set].....	62
[Live View Mode].....	62
[Monitor Display] / [Viewfinder].....	63
[Monitor Luminance].....	63
[LVF Disp.Style].....	64
[Monitor Disp. Style].....	64
[Guide Line].....	64
[Histogram].....	65
[Video Rec Area].....	66
[Remaining Disp.].....	66
[Highlight].....	66
[Expo.Meter].....	67
[Lens Resume].....	67
[MF Assist].....	68
[Economy].....	68
[Play on Monitor].....	69
[Auto Review].....	69
[No.Reset].....	69
[Reset].....	70
[USB Mode].....	70
[Output].....	71
[VIERA Link].....	71
[3D Playback].....	71
[Rotate Disp.].....	72
[Scene Menu].....	72
[Menu Resume].....	72
[Version Disp.].....	72
[Format].....	73
[Language].....	73
[Stabilizer Demo.].....	73

Application (Record)

Switching the display of recording information, etc.....	74
Using Zoom.....	75
Enlarging a subject further	76
Taking pictures with the built-in flash	78
Changing the setting of the flash.....	79
Taking pictures with Exposure Compensation.....	82
Burst function	83
Taking pictures with self-timer	86
Setting the Light Sensitivity	88
Setting coloring (White Balance)	90
Setting the White Balance manually	91
Setting the White Balance using color temperature.....	92
Performing White Balance fine adjustments.....	92
Bracket recording using White Balance	93
Taking pictures with Auto Focus	95
Taking front-on pictures of people (Face Detection).....	96
Automatically locking the focus on a moving subject (AF Tracking).....	97
Subject not centered in picture (23-area-focusing).....	98
Determined position for focus (1-area-focusing).....	98
Taking close-up pictures (Macro recording)	100
Focus range	101
[Macro Zoom].....	102
Taking pictures with Manual Focus... 103	
Technique for Manual Focus	104
Taking pictures by locking the focus and/or exposure	
[AF/AE LOCK]	105
Using the function button.....	107
Taking pictures by setting the aperture value	
[Aperture-Priority] Mode.....	108

Taking pictures by setting the shutter speed

[Shutter-Priority] Mode 109

Taking pictures by setting the aperture value and shutter speed

[Manual Exposure] Mode 110

Taking pictures with different picture effects

[Creative Control] mode 112

[Expressive] 114

[Retro] 114

[Old Days] 114

[High Key] 115

[Low Key] 115

[Sepia] 115

[Dynamic Monochrome] 116

[Impressive Art] 116

[High Dynamic] 116

[Cross Process] 117

[Toy Effect] 117

[Miniature Effect] 118

[Soft Focus] 119

[Star Filter] 119

[One Point Color] 120

Recording panorama pictures

[Panorama Shot] Mode 121

Setting the recording direction and picture effect 122

Taking pictures according to the scene

[Scene Mode] 124

[Portrait] 125

[Soft Skin] 125

[Scenery] 125

[Sports] 125

[Panning] 126

[Night Portrait] 127

[Night Scenery] 127

[Handheld Night Shot] 128

[HDR] 128

[Food] 128

[Baby] 129

[Pet] 129

[Sunset] 129

[High Sens.] 130

[Starry Sky] 130

[Glass Through] 130

[3D Photo Mode] 131

Recording motion pictures with manual operation

[Creative Video Mode] 132

Register your own settings and record

[Custom] Mode 134

[Cust.Set Mem.] 134

[Custom] 135

Recording with the Face Recognition

function [Face Recog.] 136

Registering face pictures 137

Editing or deleting information about registered persons 138

Entering Text 139

Useful features for travel 140

[Travel Date] 140

[World Time] 141

Using the [Rec] menu.....	142
[Photo Style].....	142
[Aspect Ratio].....	143
[Picture Size].....	143
[Quality].....	144
[ISO Limit Set].....	145
[ISO Increments].....	145
[Face Recog.].....	146
[AF Mode].....	146
[AF Style].....	146
[Quick AF].....	147
[AF/AE Lock].....	147
[Metering Mode].....	148
[i.Dynamic].....	148
[Min. Shtr Speed].....	149
[i.Resolution].....	149
[Digital Zoom].....	149
[Stabilizer].....	150
[AF Assist Lamp].....	151
[Flash].....	151
[Flash Synchro].....	152
[Flash Adjust].....	153
[Red-Eye Removal].....	153
[Color Mode].....	154
[Motion Deblur].....	154
[iHandheld Nite Shot].....	154
[iHDR].....	154
[Conversion].....	154
[Auto Bracket].....	155
[Date Stamp].....	156
[Clock Set].....	156
Using the [Motion Picture] menu	157
[Rec Format].....	157
[Rec Quality].....	158
[Continuous AF].....	159
[Wind Cut].....	159
[Zoom Mic].....	160

Application (View)

Changing the picture information display, etc.	161
Different playback methods	
[Playback Mode]	162
[2D/3D Settings].....	162
[Slide Show].....	163
[Filtering Play].....	165
[Calendar].....	166
Retouching pictures.....	167
[Auto Retouch].....	167
[Creative Retouch].....	168
Using the [Playback] menu.....	170
[Title Edit].....	170
[Text Stamp].....	171
[Retouch].....	172
[Video Divide].....	173
[Resize].....	174
[Cropping].....	176
[Leveling].....	177
[Favorite].....	178
[Print Set].....	179
[Protect].....	180
[Face Rec Edit].....	181
[Copy].....	182

Connecting with other devices

Viewing on TV screen	183
VIERA Link (HDMI) (HDAVI Control™)	185
Viewing 3D still pictures	187
Keeping the still pictures and motion pictures on your PC	189
About supplied software	190
Installing supplied software	191
Downloading SILKYPIX Developer Studio	192
Copying still pictures and motion pictures	193
Keeping the still pictures and motion pictures in the recorder	196
Copy by inserting the SD card into the recorder	196
Dubbing playback pictures via AV cables (optional)	196
Printing	197
Selecting a single picture and printing it	198
Selecting multiple pictures and printing them	198
Print Settings	199
Print with date and text	201

Others

Optional accessories	202
Conversion Lens (optional)	202
Protector/Filter (optional)	204
External Flash (optional)	205
AC adaptor (optional)	
DC coupler (optional)	207
List of LCD monitor/Viewfinder displays	208
In recording	208
In playback	209
Message displays	210
Q&A Troubleshooting	212
Usage cautions and notes	221

Before use

■ Camera handling

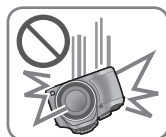

Keep the camera away from excessive vibration, force, or pressure.

- Avoid using the camera under the following conditions, which may damage the lens, LCD monitor, viewfinder, or camera body. This may also cause the camera to malfunction or prevent recording.

- Dropping or hitting the camera against a hard surface
- Pushing with excessive force on the lens, LCD monitor, or viewfinder



- **When camera is not in use or when using the playback feature, ensure that the lens is in the stored position, with lens cap on.**

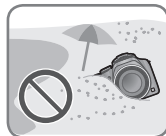

- **There are times when rattling sounds or vibrations will come from the camera, but these are due to the motion of the aperture, the zoom and the motor and do not indicate a defect.**

The camera is not dust resistant, splash resistant, or waterproof.

Avoid using the camera in places with excessive dust or sand, or where water can come into contact with the camera.

- **Avoid using the camera under the following conditions, which present a risk that sand, water, or foreign material may enter the camera through the lens or openings around buttons.** Be especially careful because these conditions may damage the camera, and such damage may not be repairable.

- In extremely dusty or sandy places
- In the rain or by the shore, where the camera may be exposed to water

■ Condensation (When the lens, the LCD monitor, or viewfinder, is fogged up)

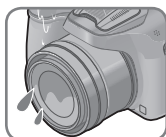

- Condensation may occur when the camera is exposed to sudden changes of temperature or humidity. Avoid these conditions, which may make the lens, LCD monitor, or viewfinder, dirty, cause mold, or damage the camera.

- If condensation does occur, turn off the camera and wait about two hours before using it. Once the camera adjusts to the surrounding temperature, the fogging will clear naturally.

■ Always take a test shot first

Before important events when you will use the camera (at weddings, for example), always take a test shot to make sure that pictures and sound record correctly.

■ No compensation for missed shots

We cannot compensate for missed shots if technical problems with the camera or card prevent recording.

■ Carefully observe copyright laws

Unauthorized use of recordings which contain works with copyright for purposes other than personal use is prohibited under copyright law. Recording of certain material may be restricted even for the purpose of personal use.

■ Also refer to “Usage cautions and notes” (→221)

- Please note that the actual controls and components, menu items, and other information for your digital camera may differ from those in the illustrations and screens provided in this manual.
- Some parts of displays, for example some of the icons, may be omitted from screens illustrated in this manual.
- Recording mode icons
In recording modes that show icons in black, you can select and execute indicated menus and functions.



C will differ depending on the recording modes registered under custom settings.

Standard Accessories

Check that all the accessories are supplied before using the camera.

- The accessories and their shape will differ depending on the country or area where the camera was purchased.
For details on the accessories, refer to Basic Owner's Manual.
- A lens hood is not supplied with this unit.
- **SILKYPIX Developer Studio is not provided on the supplied CD-ROM. Download this software from the website and install it on your computer to use. (→192)**
- Battery Pack is indicated as battery pack or battery in the text.
- Battery Charger is indicated as battery charger or charger in the text.
- SD Memory Card, SDHC Memory Card and SDXC Memory Card are indicated as card in the text.
- Please dispose of all packaging appropriately.
- Keep small parts in a safe place out of the reach of children.

■ Optional accessories

- **Cards are optional. You can record or play back pictures on the built-in memory when you are not using a card.**
- If any accessories are lost, customers in the USA and Puerto Rico should contact Panasonic's parts department at 1-800-833-9626 and customers in Canada should contact 1-800-99-LUMIX (1-800-995-8649) for further information about obtaining replacement parts.

Names and Functions of Main Parts

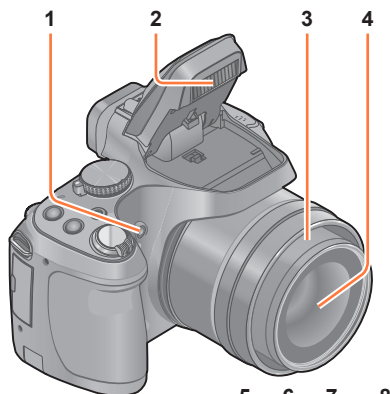

- 1 **Self-timer indicator (→86) / AF Assist Lamp (→151)**
Illuminates when the self-timer is set or when the Auto Focus is operated in dark locations.
- 2 **Flash (→78)**
Press [4] to open the flash.
- 3 **Lens barrel**
- 4 **Lens (→7, 223)**

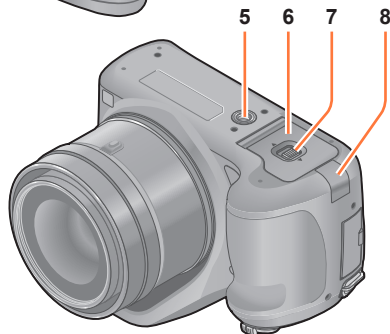

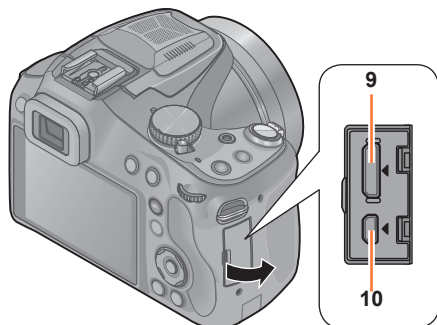

- 5 **Tripod mount (→223)**
Do not attach to a tripod with a 5.5 mm (0.22 inch) or longer screw. Doing so may damage this unit.
- 6 **Card/Battery door (→21, 207)**
Open this door to insert and remove a card or battery.
- 7 **Release lever (→21)**
- 8 **DC coupler cover (→207)**
Use the AC adaptor (optional) and DC coupler (optional) specifically for this camera.





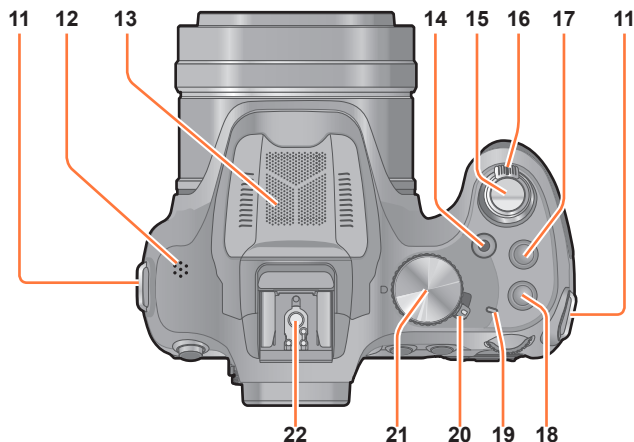

- 9 **[HDMI] socket (→184, 185)**
Do not connect any other cables except the HDMI mini cable. Doing so may cause malfunction.
- 10 **[AV OUT/DIGITAL] socket (→184, 193, 197)**

● The illustrations and screens in this manual may differ from the actual product.

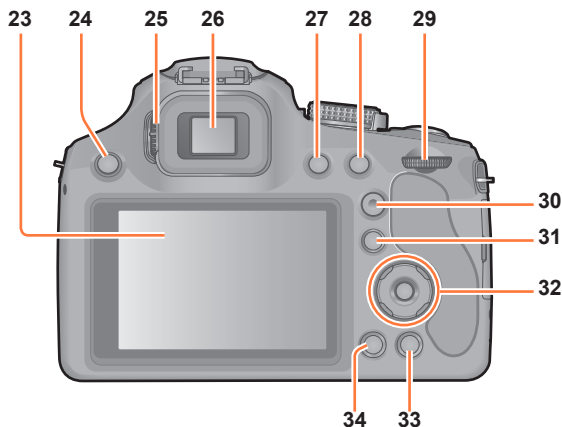

- 11 **Shoulder strap eyelet** (→16)
- 12 **Speaker** (→61)
Be careful not to cover the speaker with your finger. Doing so may make sound difficult to hear.
- 13 **Stereo microphone** (→28, 45)
- 14 **Motion picture button** (→45)
Record motion pictures.
- 15 **Shutter button** (→30)
- 16 **Zoom lever** (→75)
Use the lever to zoom in and enlarge a distant subject.
- 17 **[] (Burst Mode) button** (→83)
- 18 **[FOCUS] button** (→42, 45, 50, 99, 104)
- 19 **Power lamp** (→29)
- 20 **Camera [ON/OFF] switch** (→29)
Turns the camera on or off.
- 21 **Mode dial** (→29)
Use this to select the recording mode.
- 22 **Hot shoe** (→205)
Do not attach other than the external flash. We recommend using Panasonic flash lights (part numbers: DMW-FL220, DMW-FL360, DMW-FL360L, and DMW-FL500).



- 23 **LCD monitor** (→63, 208)
- 24 **[] (Flash open) button** (→78)
- 25 **Diopter adjustment dial** (→13)
Turn the dial to adjust the focus in the viewfinder.
- 26 **Viewfinder ([LVF])** (→13)
In this manual, “viewfinder” is used to indicate the LVF.
- 27 **[LVF] button** (→13)
Use this to switch display between viewfinder and LCD monitor.
- 28 **[AF/AE LOCK (Fn1)] button**
Use to lock the exposure and focus (→105).
Also operates as a function button (→107).
- 29 **Rear dial** (→14)
- 30 **[AF/AF-L/MF] button** (→95, 100, 103)
Switches the [Focus] setting.
- 31 **[] (Playback) button** (→31)
Use this to select the recording mode or playback mode.
- 32 **Cursor button / [MENU/SET] button** (→14)
- 33 **[] (Delete/Cancel/Quick menu) button**
You can display the Quick Menu (→60) and erase pictures (→55). You can also use this button to return to the previous screen while a menu is displayed (→58).
- 34 **[DISP.] button** (→74, 161)
Use this to change display.

Viewfinder

■ Switching the LCD monitor/Viewfinder ([LVF])

1 Press [LVF] button

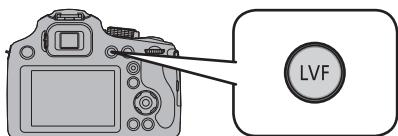

You can switch between LCD monitor display and Viewfinder display.

- For each of recording mode and playback mode, whether pictures were displayed on the LCD monitor or the viewfinder are memorized. It is possible to selectively use the viewfinder for recording pictures and the LCD monitor for playing back pictures. (Setting is memorized even if the camera is turned off).
- If [Play on Monitor] of the [Setup] menu is set to [ON], pictures will be played back on the LCD monitor after switching to playback mode. (→69)

■ Diopter adjustment

Adjust the diopter to suit your vision so that you can see the Viewfinder clearly. Look at the display on the Viewfinder and rotate the diopter adjustment dial to where the screen is in focus.

Diopter adjustment dial

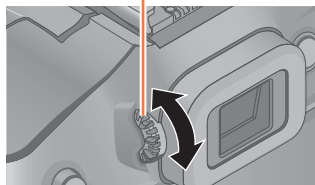

Cursor button / [MENU/SET] button

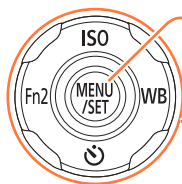
**[MENU/SET] button**

Mainly used to display menu screens or to set menu items. (→57)

Cursor button

This button is used to move the cursor on the menu screens and for other functions. (→57)

You can perform the following operations while recording.

[ISO] button

Displays the setting screen for ISO Sensitivity. (→88)

[WB] button

Displays the White Balance setting screen. (→90)

[S] button

Displays the setting screen for self-timer. (→86)

[Fn2] button

Displays the screen of the function registered to the corresponding [Fn] button. (→107)

● In this manual, the button that is to be used is indicated by ▲ ▼ ◀ ▶.

Rear Dial

There are 2 ways to operate the rear dial, rotating left or right, and deciding by pressing.

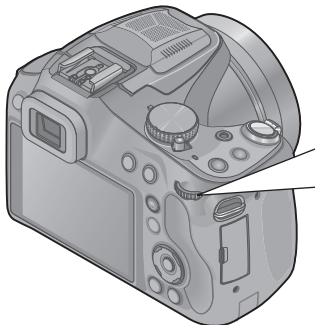
**Rotating:**

Selection of items or setting of values is performed during the various settings.

**Pressing:**

Operations that are the same as [MENU/SET] button, such as determine settings, etc., are performed during the various settings.

Attaching the Lens Cap/Shoulder Strap

Attaching the Lens Cap

When you turn the camera off or carry the camera, attach the lens cap to protect the surface of the lens.

- 1 Pass the string through the hole on the camera**

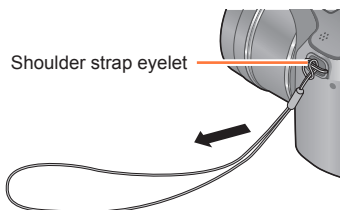

- 2 Pass the same string through the hole on the lens cap**
 - Pass the lens cap through the loop of the string and tighten it.

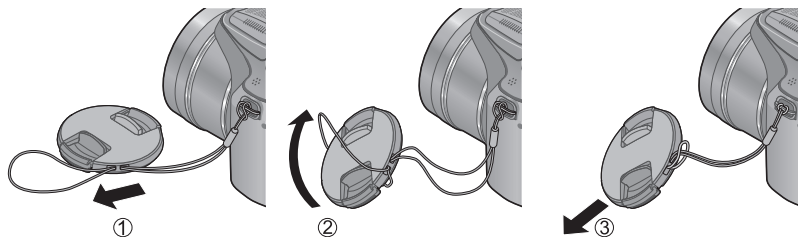

- 3 Attach the lens cap**

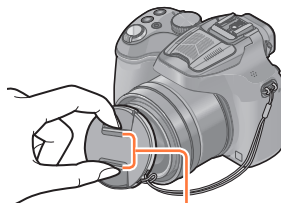

Pinch here to attach or detach the cap.

- Do not hang or swing around this unit.
- Make sure to detach the lens cap when turning this unit on.
- **Be careful not to lose the lens cap.**
- Be careful that the lens cap string does not become entangled with the shoulder strap.

Attaching the Shoulder Strap

We recommend attaching the shoulder strap when using the camera to prevent it from dropping.

1 Pass the shoulder strap through the hole at the shoulder strap eyelet

- Attach the shoulder strap so that the “LUMIX” Logo is on the outside.

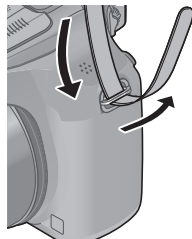

2 Pass the shoulder strap through the stopper and fasten the shoulder strap

- Attach the shoulder strap to the other side of the camera being careful not to twist it.

Pull the shoulder strap 2 cm (0.066 feet) or more.

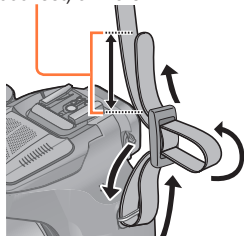

- Make sure that the shoulder strap does not come loose.

Charging battery

Always charge before first use! (battery shipped uncharged)

■ About batteries that you can use with this unit

It has been found that counterfeit battery packs which look very similar to the genuine products are made available to purchase in some markets. Some of these battery packs are not adequately provided with internal protection to meet the requirements of appropriate safety standards. There is a possibility that these battery packs may lead to fire or explosion. Please be advised that we are not liable for any accident or failure occurring as a result of use of a counterfeit battery pack. To ensure that safe products are used we recommend that a genuine Panasonic battery pack is used.

- Use the dedicated charger and battery.

1 Position the battery contacts to meet the charger, then insert the battery into the charger



2 Plug the charger into the AC power

- Plug-in type
- Inlet type

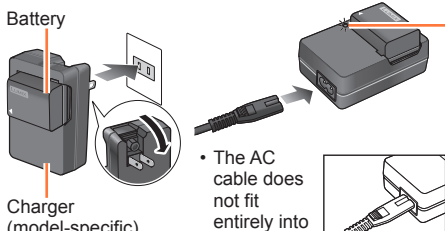

- The AC cable does not fit entirely into the AC input terminal. A gap will remain.

- We recommend charging in a location where the ambient temperature is between 10 °C and 30 °C (50 °F to 86 °F).

Charging light ([CHARGE])

- On:** Charging in progress
- Off:** Charging complete

If light is flashing:

- Charging may take longer than normal if battery temperature is too high or too low (charging may not be completed).
- Battery/charger connector is dirty. Clean with a dry cloth.

3 Detach the battery after charging is completed

- The battery charger is in the standby condition when the AC power is supplied. The primary circuit is always "live" as long as the battery charger is connected to an electrical outlet.

■ Notes on charging time

Charging time

Approx. 155 min

- The charging time indicated above is the time required for charging in case when the battery is completely used up. The time required for charging differs depending on conditions of battery usage. Charging takes longer in cases when temperatures are either high or low and when the battery has not been used for a long period of time.

- Always use genuine Panasonic batteries.
- If you use other batteries, we cannot guarantee the quality of this product.
- **Remove battery from camera after use.**
 - Keep the battery in a plastic bag, making sure that it is kept away from metallic objects (such as clips) when carrying or storing the battery.
- To remove the battery, turn the camera off and wait until the LUMIX indicator on the LCD monitor goes off. (Failure to wait may cause the camera to malfunction and may damage the card or recorded data.)
- The unusable battery should be discarded in accordance with battery recycling laws. Call the RBRC hotline at 1-800-822-8837 for information.
- You cannot charge the battery of this unit using a USB connection cable.

Remaining battery

When using the camera, the remaining battery capacity is displayed.



Remaining battery



(flashes red)

If the battery mark flashes red, recharge or replace battery. (The power lamp also blinks)

Guidelines for number of recordable pictures and operating time

The operating times and number of recordable pictures will differ according to the environment and the operating conditions.

For example, in the following cases, the operating times shorten and the number of recordable pictures is reduced.

- In low-temperature environments, such as on ski slopes.
- When using [Monitor Luminance].
- When operations such as flash and zoom are used repeatedly.

■ Recording still pictures (When using LCD monitor)

Number of recordable pictures	Approx. 400 pictures	By CIPA standard
Recording time	Approx. 200 min	

● Recording conditions by CIPA standard

CIPA is an abbreviation of "Camera & Imaging Products Association".

- [Program AE] Mode
- Temperature: 23 °C (73.4 °F)/Humidity: 50%RH when LCD monitor is on.
- Using a Panasonic SDHC Memory Card.
- Using the supplied battery.
- Starting recording 30 seconds after the camera is turned on. (When [Stabilizer] is set to [ON])
- Recording once every 30 seconds with full flash every second recording.
- Rotating the zoom lever from Tele to Wide or vice versa in every recording.
- Turning the camera off every 10 recordings and leaving it until the temperature of the battery decreases.

Number reduced if intervals are longer (e.g. to approx. one quarter for 2-minute intervals under the above conditions).

■ Recording motion pictures (When using LCD monitor)

[Rec Format]	[AVCHD]		[MP4]
[Rec Quality]	[FSH]	[SH]	[FHD]
Available recording time	Approx. 160 min	Approx. 180 min	Approx. 160 min
Actual available recording time*	Approx. 80 min	Approx. 90 min	Approx. 80 min

* The time you can actually record when repeatedly turning the camera on and off, starting and stopping recording and using zoom.

● Recording conditions

- Temperature 23 °C (73.4 °F), humidity 50%RH

- You can continuously record a motion picture in [MP4] for up to 29 minutes 59 seconds or approx. 4 GB. (Since recording in [MP4] with [FHD] creates larger files, the recording time for such motion pictures will be shorter than 29 minutes 59 seconds.)

■ Viewing pictures (When using LCD monitor)

Playback time	Approx. 330 min
---------------	-----------------

- If available battery power is significantly reduced, battery is reaching end of lifespan. Please purchase a new battery.

Inserting and Removing the Card (optional)/ the Battery

- Turn this unit off and confirm that the lens barrel is retracted.
- We recommend using a Panasonic card.

1 Slide the release lever to the [OPEN] position and open the card/battery door

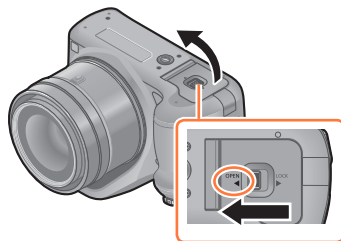

2 **Battery:** Being careful about the battery orientation, insert all the way and then check that it is locked by lever.

- Pull the lever in the direction of the arrow to remove the battery.

Card: Push it securely all the way until you hear a “click” while being careful about the direction in which you insert it.

- To remove the card, push the card until it clicks, then pull the card out upright.

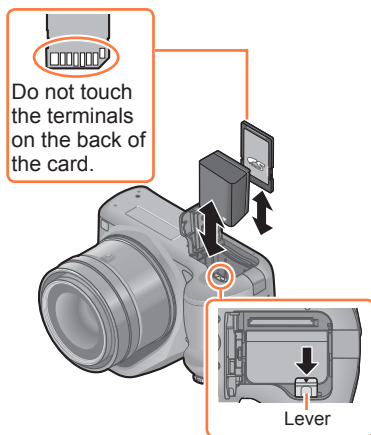

3 Close the card/battery door and slide the release lever to the [LOCK] position

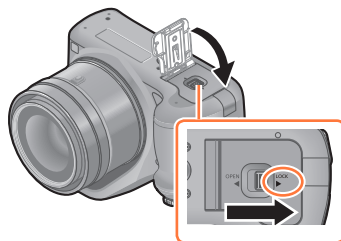

Inserting and Removing the Card (optional)/the Battery

- Remove the battery after use. (The battery will be exhausted if left for a long period of time after being charged.)
- Keep the Memory Card out of reach of children to prevent swallowing.
- Remove the card or battery after turning this unit off, with the power lamp completely turned off and the lens barrel retracted completely. (The camera may not function properly, or the card or recorded contents may be damaged.)
- When using an AC adaptor (optional) and DC coupler (optional) instead of the battery, refer to ([→207](#)).

About the Built-in Memory/the Card

The following operations can be performed using this unit:

When a card has not been inserted	Pictures can be recorded on the built-in memory and played back.
When a card has been inserted	Pictures can be recorded on the card and played back.



When using the built-in memory

(access indication*)

When using the card

(access indication*)

* The access indication is displayed in red when pictures are being recorded on the built-in memory (or the card).

■ Built-in memory (approx. 200 MB)

- Pictures may be copied between cards and the built-in memory. (→182)
- The access time for the built-in memory may be longer than the access time for a card.

■ Compatible memory cards (optional)

The following SD standard-based cards (Panasonic brand recommended) can be used.

Type of Card	Capacity	Notes
SD Memory Cards	8 MB – 2 GB	<ul style="list-style-type: none"> • Can be used with devices compatible with the respective formats. • Before using SDXC Memory Cards, check that your computer and other devices support this type of card. http://panasonic.net/avc/sdcard/information/SDXC.html • Use a card of SD Speed “Class 4”* or higher for recording motion pictures. • Only the cards listed on the left with the given capacities are supported.
SDHC Memory Cards	4 GB – 32 GB	
SDXC Memory Cards	48 GB, 64 GB	

* SD speed class refers to a specification for sustained write speeds. Confirm the SD speed by checking the card label or other card related materials.

(Example)

CLASS

- Latest information:

<http://panasonic.jp/support/global/cs/dsc/>

(This site is available in English only.)

- While the camera is accessing the card or built-in memory (for an operation such as picture writing, reading, deletion, or formatting), do not turn off the camera or remove the battery, card, AC adaptor (optional) or DC coupler (optional). Do not subject the camera to vibrations, impact, or static electricity. The card or the data on the card may be damaged, and this unit may no longer operate normally. If operation fails due to vibration, impact or static electricity, perform the operation again.
- Please reformat the card with this camera if it has already been formatted with a computer or another device. (→73)
- If the write-protect switch is set to "LOCK", the card cannot be used to record or delete pictures, and it cannot be formatted.
- It is recommended that you copy important pictures to your computer (as electromagnetic waves, static electricity, or faults may cause data to be damaged).
- Make sure that there are no foreign materials such as dust or water on the terminals on the back of the card. Do not touch the terminals with your hand. Doing so may cause this unit to malfunction.



Recording capacity guidelines (pictures/recording time)

■ About the display of the number of recordable pictures and available recording time

- Switching between the display of number of recordable pictures and available recording time can be performed in the [Remaining Disp.] (→66) in the [Setup] menu.
- The number of recordable pictures and the available recording time are an approximation. (These vary depending on the recording conditions and the type of card.)

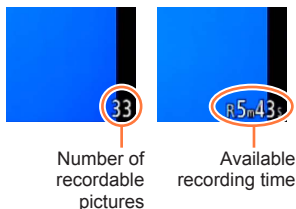

■ Recording picture capacity (still pictures)

[Picture Size]	Built-in memory	2 GB	32 GB	64 GB
4:3 16M	33	300	4910	9880
4:3 5M	74	650	10620	21490
4:3 0.3M	1140	10050	162960	247150

- When the number of recordable pictures exceeds 99,999, "+99999" is displayed.

■ Recording time capacity (motion pictures)

([h], [m] and [s] indicate “hour”, “minute” and “second”.)

When [Rec Format] is [AVCHD]

[Rec Quality]	2 GB	32 GB	64 GB
[FSH] [SH]	15m00s	4h10m00s	8h27m00s

When [Rec Format] is [MP4]

[Rec Quality]	Built-in memory	2 GB	32 GB	64 GB
[FHD]	—	12m00s	3h23m00s	6h51m00s
[HD]	—	23m00s	6h28m00s	13h05m00s
[VGA]	5m00s	52m00s	14h14m00s	28h48m00s

- The time displayed in the table is the total time.
- You can continuously record a motion picture in [MP4] for up to 29 minutes 59 seconds or approx. 4 GB. (Since recording in [MP4] with [FHD] creates larger files, the recording time for such motion pictures will be shorter than 29 minutes 59 seconds.)

Setting the clock

The clock is not set when the camera is shipped.

- Before using the camera, remove the lens cap.

1 Turn the camera on

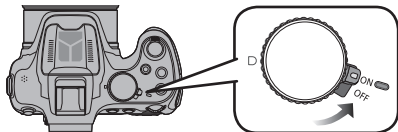

- The power lamp lights when you turn this unit on.
- If the language select screen is not displayed, proceed to step 4.

2 Press [MENU/SET]

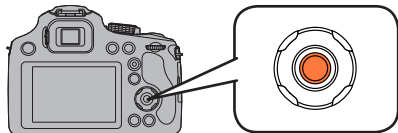

3 Press ▲ ▼ to select the language, and press [MENU/SET]

- The [Please set the clock] message appears.

4 Press [MENU/SET]

5 Press ◀ ▶ to select the items (year, month, day, hour, minute, display order or time display format), and press ▲ ▼ to set

(A): Time at the home area

(B): Time at the travel destination

- To cancel → Press [(Q.MENU)] button.



6 Press [MENU/SET] to set

7 Press [MENU/SET]

- If the clock is not set, the correct date cannot be printed when you order a photo studio to print the picture, or when you stamp the date on the pictures with [Date Stamp] or [Text Stamp].
- If the clock is set, the correct date can be printed even if the date is not displayed on the screen of the camera.

To change time setting

When resetting date and time, select [Clock Set] from the [Setup] menu or [Rec] menu.

- Clock settings will be saved for approx. 3 months even after the battery is removed, provided a fully charged battery was installed in the camera for 24 hours beforehand.

1 Select [Clock Set] from the [Setup] menu or [Rec] menu

- For details about how to set the menu (→57)

2 Set the date and time (Perform steps **5** - **6**. (→26))

Tips for taking good pictures

Hold the camera gently with both hands, keep your arms still at your side and stand with your feet slightly apart.

- Be careful not to put your fingers on the flash, AF Assist Lamp, microphone, speaker or lens etc.
- Be careful not to cover the speaker with your finger. Doing so may make sound difficult to hear. (→11)
- Be careful not to move the camera when you press the shutter button.
- When taking pictures, make sure your footing is stable and there is no danger of colliding with another person, an object etc.
- Do not hold the lens barrel as you take pictures. There is a risk that your finger will be trapped as the lens retracts.

AF Assist Lamp



Stereo microphone

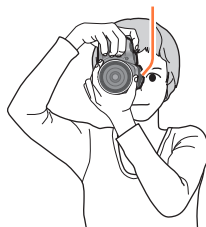

Holding the camera vertically

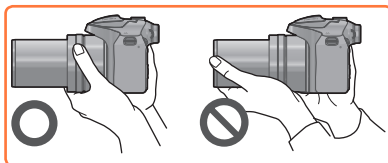

■ Direction Detection Function ([Rotate Disp.])

Pictures recorded with the camera held vertically are played back vertically (rotated). (Only when [Rotate Disp.] (→72) is set)

- When the camera is held vertically and tilted up and down to record pictures, the Direction Detection function may not work correctly.
- Motion pictures cannot be displayed in portrait orientation.
- You cannot record 3D pictures in vertical orientation.

Preventing jitter (camera shake)

When the Jitter alert ([Jitter]) appears, use [Stabilizer] (→150), a tripod or the Self-timer (→86).

- Shutter speed will be slower particularly in the following cases. Keep the camera still from the moment the shutter button is pressed until the picture appears on the screen.
 - Slow sync./Red-Eye Reduction
 - [Night Portrait]/[Night Scenery]/[Starry Sky] ([Scene Mode])
 - When the shutter speed is slowed in [Min. Shtr Speed]

Sequence of operations

1 Turn the camera on

- The power lamp lights when you turn this unit on.

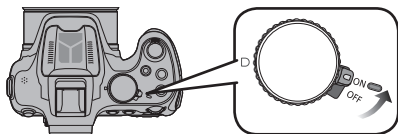

2 Set to the desired recording mode

Rotate the mode dial slowly to select the desired mode. →

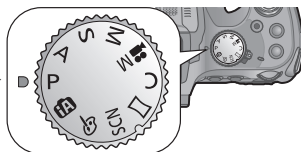

■ Basic

P	[Program AE] Mode	Take pictures with automatic shutter speed and aperture value settings. (→32)
iA	[Intelligent Auto] Mode	Take pictures with automatic settings. (→36)

■ Advanced

A	[Aperture-Priority] Mode	Determine aperture, then record pictures. (→108)
S	[Shutter-Priority] Mode	Determine shutter speed, then record pictures. (→109)
M	[Manual Exposure] Mode	Determine aperture and shutter speed, then record pictures. (→110)
M	[Creative Video Mode]	Record motion picture with manual settings. (→132)
C	[Custom] Mode	Record pictures using pre-registered settings. (→134)
SCN	[Panorama Shot] Mode	Record panorama pictures. (→121)
SCN	[Scene Mode]	Take pictures using Scene modes. (→124)
CC	[Creative Control] Mode	Take pictures by selecting your preferred picture effect. (→112)

(Continued on the next page)

Use the zoom lever to adjust the range of the picture to be taken (→75)

3

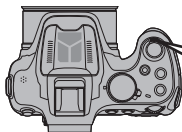

Capture a wider area
(wide-angle)



Enlarge the subject
(telephoto)

Aim the camera and shoot

■ **Taking still pictures**

- ① Press the shutter button halfway to focus
- ② Press the shutter button fully to take the picture

Focus display



4

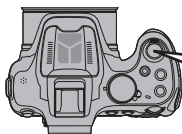

Press halfway
(press lightly to focus)



Press fully
(press the button all the way to record)

■ **Recording motion pictures**

- ① Press the motion picture button to start recording
- ② Press the motion picture button again to finish recording

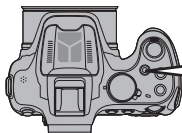

(Continued on the next page)

Play back pictures

① Press the Playback button

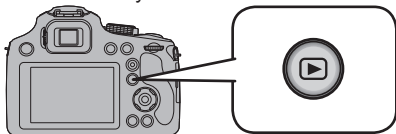

5

② Press ◀▶ to select a picture to be displayed

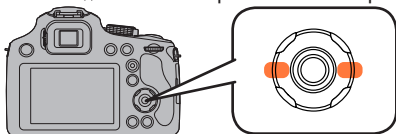

■ Viewing motion pictures

Select a picture with the motion picture icon, and press ▲.

6

Turn the camera off

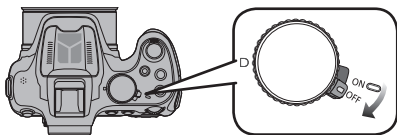

Taking pictures with your own settings

[Program AE] Mode



Take pictures with automatic shutter speed and aperture value settings. Using the [Rec] menu to change settings and set up your own recording environment.

1 Set to [P] ([Program AE] Mode)

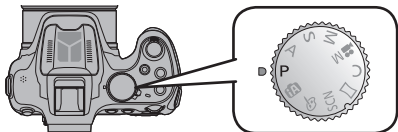

2 Take a picture

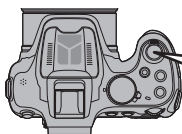

Press halfway
(press lightly to focus)



Press fully
(press the button all the way to record)

■ Adjusting the focus and checking the exposure



Ⓐ Aperture value

Ⓑ Shutter speed

Ⓒ ISO sensitivity

Ⓓ Focus display

(When focus is aligned: illuminated
When focus is not aligned: flashing)

Ⓔ AF area

- Aim the AF area at the point you want to focus on.
- The shortest recording distance varies depending on the zoom ratio. Check the focus range display on the screen. (→101)
- Aperture value and shutter speed are displayed in red when correct exposure is not achieved. (Except when using a flash)
- If aperture and shutter speed are shown in red, you do not have appropriate exposure. You should either use the flash, change [Sensitivity] settings or set [Min. Shtr Speed] to a slower speed.

Program Shift

The function for maintaining the same exposure (brightness) while changing the shutter speed and aperture value combination is called "Program Shift". You can use "Program Shift" to take pictures by adjusting the shutter speed and aperture value even in [Program AE] Mode.

1 Press the shutter button halfway

- The shutter speed and aperture value are displayed on the screen.

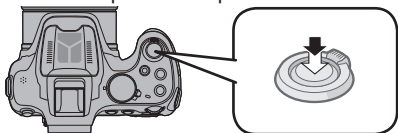

2 Rotate the rear dial while the values are displayed (approximately 10 seconds) to select a combination of shutter speed and aperture value

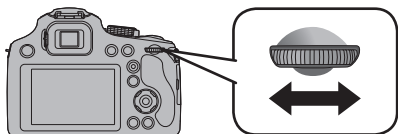

Exposure meter

Shutter speed (Automatic adjustment)

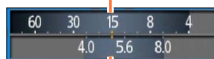

Aperture value (Automatic adjustment)

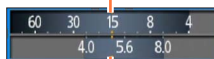

[P_✓] is displayed during Program Shift (while the combination of a shutter speed and aperture value is being changed).

- To cancel Program Shift
→ Rotate the rear dial until the Program Shift indicator goes off ([P_✓]).

- When the camera is turned off, Program Shift is canceled.
- Program Shift is canceled if more than 10 seconds pass after Program Shift is activated. However, the Program Shift setting is memorized.
- Depending on the brightness of the subject, Program Shift may not be activated.
- Program Shift is available in all [Sensitivity] settings except [ISO].

■ Example of Program Shift

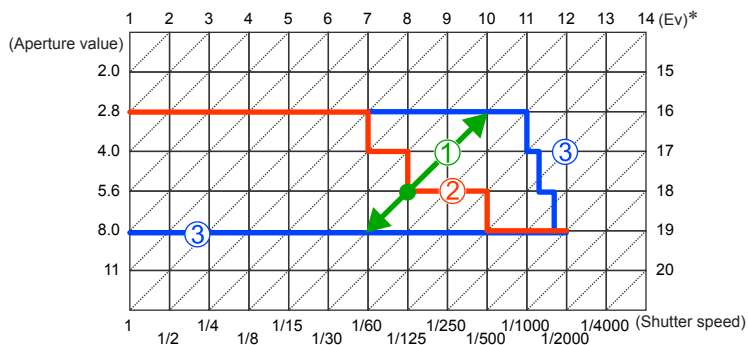

① Program Shift amount

② Program Shift diagram

③ Program Shift limit

* EV is an abbreviation of [Exposure Value], a unit indicating the amount of exposure. The EV changes with the aperture value or the shutter speed.

How to adjust focus

When [AF Mode] is set to [□] (1-area-focusing), focus on the AF area in the center of the picture. If a subject you want to record is not in the center, follow the steps below.

1 First adjust focus according to subject

Align the AF area
with the subject



Hold down halfway



Focus display

(When focus is aligned: illuminated
When focus is not aligned: flashing)

AF area

(When focus is aligned: green
When focus is not aligned: red)

2 Return to desired composition



Press fully



AF area

■ Subjects and environments that make focusing difficult

Subjects/environments which may make focusing difficult:

- Fast-moving or extremely bright objects, or objects with no color contrast.
- Taking pictures through glass or near objects emitting light.
- In the dark, or with significant jitter.
- When too close to object or when taking pictures of both distant and close objects together in the same picture. (→101)

The focus display flashes and beep sounds when focus is not aligned.



Focus display

Use the focus range displayed in red as a reference.

Even if the focus display is lit, the camera may be unable to bring the subject into focus if it is out of range.

- The AF area display may be larger depending on recording conditions such as dark locations or zoom ratio.

Taking pictures with automatic settings

[Intelligent Auto] Mode



This mode is recommended for those who want to point and shoot or beginners as the camera optimizes settings to match the subject and recording environment.

1 Set to [iA] ([Intelligent Auto] Mode)

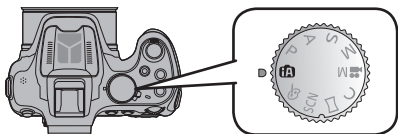

2 Take a picture

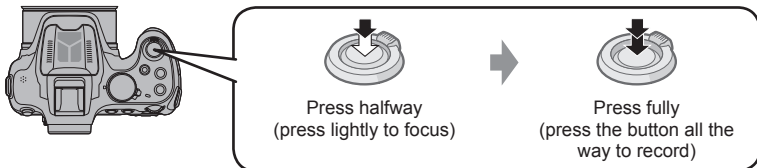

Focus display
(When focus is aligned: illuminated
When focus is not aligned: flashing)

AF area

- The AF area is displayed around the subject's face by the Face Detection function. In other cases, it is displayed at the point on the subject which is in focus.
- You can set the AF tracking by pressing [FOCUS]. For details, refer to (→42).

- The following functions are activated automatically.
 - Scene Detection/Backlight Compensation/Intelligent ISO sensitivity control/ Auto White Balance/Face Detection/[AFS]/[Quick AF]/[i.Dynamic]/[i.Resolution]/ [i.ZOOM]/[Stabilizer]/[AF Assist Lamp]/[Red-Eye Removal]/[Continuous AF]
- Image quality is fixed to [].

Automatic Scene Detection

Camera reads scene when pointed at subject, and makes optimum settings automatically.



The icon of scene detected

When taking pictures

[i-Portrait]	[i-Night Portrait]* ² (Only when the flash is opened)
[i-Baby]* ¹	[i-Night Scenery]* ²
[i-Scenery]	[i-Handheld Nite Shot]* ³
[i-Sunset]	[i-Macro]
When scene does not correspond to any of the above	

When recording motion pictures (→45)

[i-Portrait]	[i-Low Light]
[i-Scenery]	[i-Macro]
When scene does not correspond to any of the above	

*¹ When children (that are registered in the camera with Face Recognition) under 3 years old are recognized.

*² We recommend using a tripod and the self-timer.

*³ When [i-Handheld Nite Shot] is [ON].

- Depending on recording conditions, different scene types may be determined for the same subject.
- If desired scene type is not selected, we recommend manually selecting the appropriate scene mode.
- When , or is detected, Face Detection is activated, and the focus and exposure are adjusted for the recognized faces.
- If a tripod is used, for instance, and the camera has judged that camera shake is minimal when the Scene Mode has been identified as , the shutter speed will be set to a maximum of 8 seconds. Take care not to move the camera while taking pictures.
- When [Face Recog.] is set to [ON], and the face similar to the registered face is detected, [R] is displayed in the top right of , and .

■ About Backlight Compensation

Backlight compensation is automatically activated in [Intelligent Auto] mode. Backlight is a condition where a light shines from behind a subject. When there is a backlight, the subject appears darker and the camera will automatically attempt to correct it by increasing the brightness of the picture. When the camera detects backlight, is displayed on the LCD monitor. (Depending on the backlighting conditions, backlighting may not be detected correctly.)

Defocusing the background

You can also use [Intelligent Auto] Mode to adjust background defocusing easily, as with in [Aperture-Priority] mode.

1 Press the rear dial

- The adjustment screen is displayed.

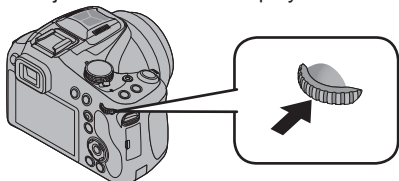
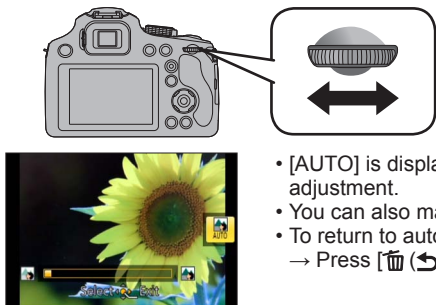
**2 Rotate the rear dial to adjust the background defocusing condition**

- [AUTO] is displayed in the icon during automatic adjustment.
- You can also make adjustments with ◀▶.
- To return to automatic adjustment
→ Press [⏏] (Q.MENU) button

Defocus background condition

Defocus the background



Focus the background

3 Press the rear dial to finalize the setting

- You can also press [MENU/SET] to finalize the setting.

- When you record motion pictures, the camera performs aperture control within the appropriate exposure range, and the background defocusing may not change for some subject brightness.
- You can use [Intelligent Auto Plus] Mode to adjust brightness and coloring. (→43)
- When you turn off the unit or change the recording mode, the background defocusing condition setting will return to [AUTO].
- The adjustment range of the background defocusing condition will change according to the zoom position.

About flash

Open the flash to use the built-in flash. (→78)

- Set to [iA], [iA], [iA] or [iS] depending on the subject and brightness.
- When [iA] or [iA] is displayed, the [Red-Eye Removal] function is activated to automatically detect red-eye and correct the picture data.
- When [iA] or [iS] is selected, the shutter speed is reduced.

About [Intelligent Auto] setting items

Following menus can be set.

- For the setting procedures of the menu. (→57)

Menu	Item
[Intelligent Auto]	[Intelligent Auto] [Intelligent Auto Plus]
[Rec]	[Picture Size]* [Color Mode] [Motion Deblur] [iHandheld Nite Shot] [iHDR] [Face Recog.]
[Motion Picture]	[Rec Format] [Rec Quality]
[Setup]	[Clock Set] [World Time] [Beep]* [Language] [Stabilizer Demo.] • Menu items other than those listed above are not displayed, but you can set them in other recording modes.

* Available settings may be different from other recording modes.

[Color Mode]

When you change the [Color Mode] setting in the [Rec] menu, you can change the color of still pictures and motion pictures to be recorded.

- For the setting procedures of the menu. (→57)

■ Settings

[STANDARD]	Records pictures with colors close to the actual colors.
[Happy]	Records pictures with sharp and vivid colors.
[B&W]	Records pictures in black and white monotoes.
[SEPIA]	Records pictures with sepia tones.

[Motion Deblur]

[Motion Deblur] automatically sets the optimum shutter speed in accordance with the movements of the subject to minimize the blur of the subject.

It is preset to [ON] with this unit.

- For the setting procedures of the menu. (→57)

- When [Motion Deblur] is set to [ON], and the shutter button is pressed halfway, [☺]] appears on the screen.
- The subject may be recorded in a picture size smaller than the number of pixels that has been set.

[iHandheld Nite Shot]

If a night scene is detected automatically while the unit is being handheld, [iHandheld Nite Shot] can record a still picture with less jitter and less noise without using a tripod by combining a burst of pictures.

It is preset to [ON] with this unit.

- For the setting procedures of the menu. (→57)

- When the camera is fixed in place on a tripod or by other means, [iHandheld Nite Shot] will not be identified.

[iHDR]

When there is, for example, strong contrast between the background and the subject, [iHDR] records multiple still pictures with differing exposures and combines them to create a single still picture rich in gradation.

It is preset to [ON] with this unit.

- For the setting procedures of the menu. (→57)

- This function is automatically activated only when  (→37) is displayed on the LCD monitor.
- In the case that a single picture is going to be composed from a burst, a message indicating that multiple pictures are to be recorded appears on the screen and burst recording is carried out. Note that burst recording will not take place if the camera determines that it can compensate for the difference in contrast without composing the picture from a burst.
- In the case of composition from a burst, afterimages may appear if the subject was moving.
- The camera does not combine pictures in the following cases:
 - When the zoom ratio exceeds the maximum optical zoom ratio
 - [Burst] mode
 - When the flash fires.

AF Tracking

In [Intelligent Auto] Mode, you can select [AF Tracking] in [AF Mode] in a single operation. When [AF Tracking] mode is used, the camera can continuously focus on a subject and adjust the exposure of the subject even when the subject is moving.

1 Press [FOCUS] to set [AF Tracking]

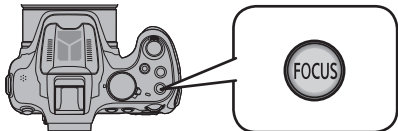

• To cancel AF Tracking → Press [FOCUS] again.

2 Align the AF Tracking frame with the subject

3 Press [AF/AE LOCK (Fn1)] button to lock

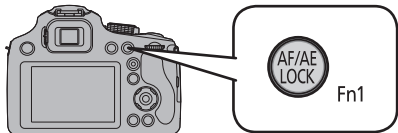

• To cancel AF Lock → Press [FOCUS].

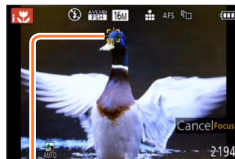

AF Tracking frame
 AF Lock successful: Yellow
 AF Lock failed: Red

- The optimal scene for the AF locked subject is automatically identified.
- You cannot use AF Tracking Function when [Color Mode] is set to [B&W] or [SEPIA].
- Face Recognition will be inactive while using AF Tracking.
- Under certain recording conditions, such as when the subject is small or when it is dark, [AF Tracking] may not operate correctly.

[Intelligent Auto Plus] Mode

When [Intelligent Auto Plus] (iA+) mode is selected, you can easily adjust the brightness and coloring, in addition to the background defocusing, without compromising the user-friendly operation of the [Intelligent Auto] Mode.

■ Switching to [Intelligent Auto Plus] Mode

Use the [Intelligent Auto] menu to switch the mode.

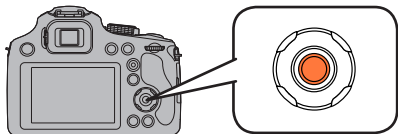
1 Press [MENU/SET]**2 Press ► to select [iA+] and press [MENU/SET]**

iA: [Intelligent Auto] Mode
iA+: [Intelligent Auto Plus] Mode

■ Adjusting brightness, coloring, and background defocusing

1 Press the rear dial

- The adjustment screen is displayed.

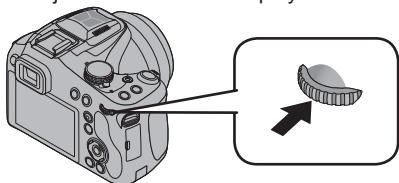

2 Press ▲ ▼ to select an item to adjust

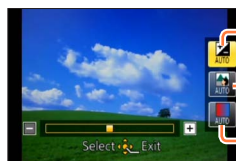

Adjusts brightness.

Adjusts background defocusing.

Adjusts coloring.

- [AUTO] is displayed in the icon during automatic adjustment.

3 Press ◀ ▶ to make adjustments

Brightness	Underexposure (dark)	◀ ▶	Overexposure (bright)
Defocus background condition	Defocus the background	◀ ▶	Focus the background
Coloring	Warm colors	◀ ▶	Cool colors

- You can also rotate the rear dial to make adjustments.
- To return to automatic adjustment → Press [MENU/SET] (Q.MENU) button.

4 Press [MENU/SET]

- You can also press the rear dial to finalize the setting.

- When you record motion pictures, the camera performs aperture control within the appropriate exposure range, and the background defocusing may not change for some subject brightness levels.
- When you turn off the unit or change the recording mode, all settings are returned to [AUTO].
- The adjustment range of the background defocusing condition will change according to the zoom position.

Recording motion pictures



You can record motion pictures with audio (stereo).

1 Press the motion picture button to start recording

Do not block the microphone when recording motion pictures.

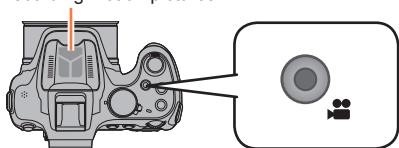

- It is recommended that you close the flash when recording motion pictures.
- Immediately release the motion picture button after pressing it.
- You can also use zoom while recording motion pictures.
- Focus can be achieved during recording by pressing [FOCUS].
- Still pictures can be taken during motion picture recording. (→48)

Recording state indicator

[Rec Format] (→157)/
[Rec Quality] (→158)



Elapsed recording time

Remaining recording time
(approx.)

2 Press the motion picture button again to end recording

■ About the recording format for recording motion pictures

This unit can record motion pictures in either AVCHD or MP4 formats.

AVCHD:

You can record high definition quality images with this format. It is suitable for viewing motion pictures on a high-resolution TV or for saving them to a disc.

MP4:

This is a simpler video format best used when extensive editing is needed, or when uploading videos to WEB services.

- You can record a motion picture to the built-in memory only in [MP4] using the [VGA] setting.

■ About the compatibility of the recorded motion pictures

Motion pictures recorded in [AVCHD] or [MP4] may be played back with poor picture or sound quality or playback may not be possible even when played back with equipment compatible with these formats. Also, the recording information may not be displayed properly. In this case, use this unit.

- The available recording time displayed on the screen may not decrease regularly.
- If data is repeatedly recorded and deleted, the total available recording time on the SD card may be reduced. To restore the original capacity, use the camera to format the SD card. Be sure to save all important data to your computer or other media before formatting, as all data saved to the card will be erased.
- Depending on the type of the card, the card access indication may appear for a while after recording motion pictures. This is not a malfunction.
- ISO sensitivity will operate as [AUTO] in Motion Picture Recording other than Creative Video. Also, [ISO Limit Set] will not function.
- There is a risk that the sound of zoom and button operations and the rubbing of the lens cap string will be recorded, and so care is necessary.
- Depending on the environment when recording motion pictures, the screen may turn black for an instant or noise may be recorded because of static electricity, electromagnetic waves, etc.
- The recording range may become narrower in motion pictures compared to still pictures. Also, if the aspect ratio is different for still pictures and motion pictures, the angle of view will change when starting to record a motion picture. The recordable area is displayed by setting [Video Rec Area] (→66) to [ON].
- If Extended optical zoom is used before pressing the motion picture button, these settings will be cleared, and the recordable area will be changed significantly.
- When using zoom while recording motion pictures, it may take some time to focus.

- We recommend using a tripod and self-timer when you record motion pictures using high zoom magnification.
- It is recommended to use a fully charged battery or AC adaptor (optional) when recording motion pictures.
- If while recording motion pictures using the AC adaptor and the power supply is cut off due to a power outage or if the AC adaptor is disconnected etc., the motion picture being recorded will not be recorded.
- Motion pictures cannot be recorded in the following cases.
 - [3D Photo Mode] ([Scene Mode])
 - [Soft Focus]/[Star Filter] ([Creative Control] Mode)
- It will be recorded in the following categories for certain recording modes. A motion picture recording matching each recording mode will be performed for the ones not listed below.

Selected recording mode	Recording mode while recording motion picture
<ul style="list-style-type: none"> • [Program AE] Mode • [Aperture-Priority] Mode • [Shutter-Priority] Mode • [Manual Exposure] Mode • [Sports]/[HDR]/[Pet] ([Scene Mode]) 	Normal motion picture
[Baby] ([Scene Mode])	Portrait Mode
[Night Portrait]/[Night Scenery]/[Handheld Night Shot]/[Starry Sky] ([Scene Mode])	Low Light Mode

Recording still pictures while a motion picture is being recorded

Still pictures can be recorded even while a motion picture is being recorded.

1 Press the shutter button fully during the motion picture recording

Still pictures can be taken while a motion picture is being recorded.

[Aspect Ratio]	[Still Picture Size]	Number of recordable pictures
16:9	3.5M	1

- The picture quality may be different to [3.5M] (16:9) of standard pictures.
- When still pictures are recorded during zooming, the zooming may stop.
- Using [Miniature Effect] in [Creative Control] Mode, a still picture may be taken with a slight delay from the time when the shutter button is pressed fully.

- When you press the shutter button halfway during motion picture recording, the camera will automatically refocus on a subject. This refocus movement is recorded even during motion picture recording. When priority is to be given to the motion picture videos, press the shutter button fully, and record the still pictures. Still pictures can also be created after motion picture recording. (→54)
- When the shutter button is pressed halfway, the picture size and the number of recordable pictures are displayed.
- Still pictures cannot be recorded in the following cases:
 - When [Rec Quality] is set to [VGA]
 - [Creative Video Mode]
- The flash is set to [ⓧ].
- Since the electronic shutter is used for recording, the pictures recorded may be distorted.
- When [Quality] is set to [RAW₁], [RAW₂] or [RAW], still pictures are recorded with the [ⓧ] setting in JPEG file format.

Viewing your pictures [[Normal Play]]

When a card is in the camera, pictures are played back from the card, and without a card, pictures are played back from the built-in memory.

1 Press the Playback button

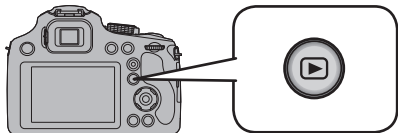

2 Press ◀▶ to select a picture to be displayed

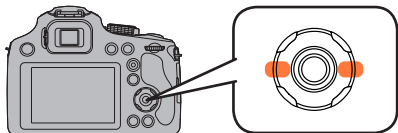

- When you press and hold the button, the pictures are displayed one after another.
- You can also rotate the rear dial to select a picture.

3 View pictures



Folder/File number

Picture number/Total pictures

Ending Playback

Press the Playback button or the motion picture button again, or press the shutter button halfway.

- It may not be possible to view pictures on this camera that were previously edited on a computer.
- When the camera is switched to playback mode, the lens barrel will be retracted after approx. 15 seconds.
- This camera is compliant with the unified DCF (Design rule for Camera File system) standard formulated by the Japan Electronics and Information Technology Industries Association (JEITA), and with Exif (Exchangeable image file format). Files that are not DCF-compliant cannot be played back.

Zooming in and viewing "Playback Zoom"

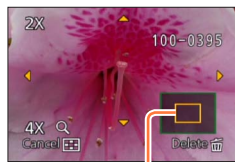
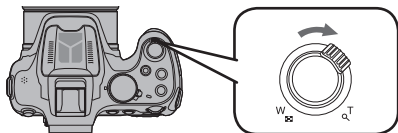
1 Move the zoom lever toward T side

Current zoom position

- Each time you move the zoom lever toward the T side, the magnification increases through four levels: 2x, 4x, 8x, and 16x. (The picture quality displayed becomes successively lower.)
- To reduce zoom → Move the zoom lever toward W side
- Move zoom position → Press ▲▼◀▶

- Playback zoom cannot be used during motion picture playback or panorama picture playback.

■ Switching the displayed picture without changing the zoom ratio and position of Playback zoom

Rotate the rear dial during Playback zoom.

- The zoom position returns to the center in the following images.
 - Images with different aspect ratios
 - Images with different numbers of recorded pixels
 - Images with a different rotation direction (when [Rotate Disp.] is set to [On])

■ Enlarging the focus point

Press [FOCUS] when playing back still pictures.

- Focus point may not be the center of enlargement when it is at the edge of the still picture.
- It will return to the original enlargement if [FOCUS] is pressed again.
- Following still pictures cannot be enlarged because there is no focus point:
 - Still pictures that was taken without focusing
 - Still pictures that was taken with Manual Focus
 - Still pictures that was taken with a different camera

Viewing a list of pictures "Multi Playback"

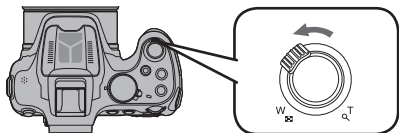
1 Move the zoom lever toward W side

Picture no./Total no.



- Move the zoom lever toward the W side and you can switch the display methods in the following order: 1-picture screen (full-screen) → 12-picture screen → 30-picture screen → Calendar screen. (Move the lever to the T side to return.)
- When you select a picture using ▲ ▼ ◀ ▶ and press [MENU/SET] on a 12-picture or 30-picture screen, the selected picture is displayed on a 1-picture screen (full-screen).

● Pictures displayed with [!] cannot be played back.

Viewing pictures by their recording date [Calendar]

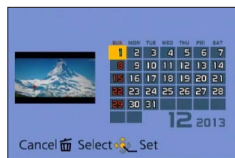
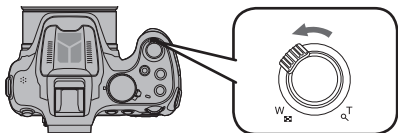
1 Move the zoom lever toward W side several times

- If there were no pictures recorded during a month, that month is not displayed.

2 Press **▲ ▼ ◀ ▶** to select recording date and press [MENU/SET]

- Press [🗑️ (➡️ Q.MENU)] button to return to the calendar screen.

- The recording date of the picture selected in the playback screen becomes the date selected when the calendar screen is first displayed.
- If there is more than one picture recorded on the same date, the first picture taken on that date will be selected.
- You can display the calendar between January 2000 to December 2099.
- Only months when pictures were taken are shown on the calendar screen. Pictures taken without clock settings are displayed with the date January 1st, 2013.
- Pictures taken with destination settings made in [World Time] are displayed in the calendar screen using the appropriate date for the destination's time zone.

Viewing motion pictures

This unit was designed to play motion pictures using the AVCHD, MP4 and QuickTime Motion JPEG formats.

1 Select a picture with the motion picture icon, and press ▲

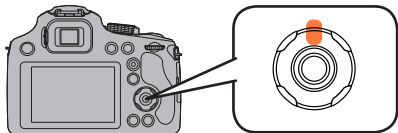

Playback now starts. (After playback starts, the elapsed playback time is displayed on the screen.)

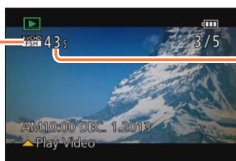

Motion picture recording time
Example)
10 minutes 30 seconds: 10m30s

Motion picture icon (differs depending on [Rec Format] and [Rec Quality] setting)

■ Operations during motion picture playback

▲: Pause/play

▼: Stop

◀: Fast rewind (2 steps*)/Single-frame rewind (while paused)

▶: Fast forward (2 steps*)/Single-frame forward (while paused)

*The fast forward or rewind speed increases if you press ◀▶ again.

- Volume can be adjusted with the zoom lever.

- It may not be possible to properly play back the motion pictures recorded using other cameras.
- Some information will not be displayed for motion pictures recorded in [AVCHD].
- Motion pictures can be viewed on your computer using "PHOTOfunSTUDIO" on the supplied CD-ROM.
- Motion pictures recorded with [Miniature Effect] in [Creative Control] Mode play back at approximately 10 times speed.
- When using a high capacity card, it is possible that fast rewinding may be slower than usual.

Capturing still pictures from motion pictures

Save a scene from a motion picture as a still picture.

- 1 Display the picture that you want to capture as a still picture by pausing a motion picture during playback**

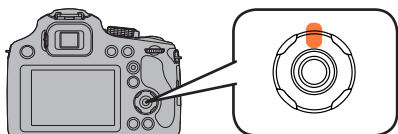

- 2 Press [MENU/SET]**



- A confirmation screen is displayed. If you select [Yes], the operation is executed.

- Still pictures are saved with [Aspect Ratio] setting of 16:9 and [Picture Size] at 2M*.
- *In the following cases, saved pictures become 4:3, 0.3M.
 - MP4 motion pictures with [Rec Quality] of [VGA]

- Still pictures created from a motion picture may be coarser than with normal picture quality.
- It may not be possible to capture still pictures from motion pictures that were recorded with a different camera.

Deleting pictures

Pictures will be deleted from the card if the card is inserted, or from the built-in memory if the card is not inserted. (Deleted pictures cannot be recovered.)

However, pictures will not be deleted in the following cases.

- Protected pictures
- Card switch is in "LOCK" position.
- Pictures not of DCF standard (→49)

1 Press [🗑️ (↩️ Q.MENU)] button to delete displayed picture

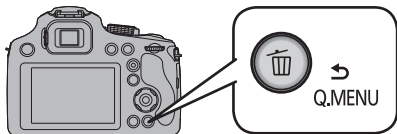

- A confirmation screen is displayed. When you select [Yes], the selected picture is deleted.

- Do not turn off the camera during deletion.
- Use a sufficiently charged battery or an AC adaptor (optional) and DC coupler (optional).

To delete multiple (up to 50)/To delete all pictures

1 Press [🗑️] (↵ Q.MENU) button while viewing a picture

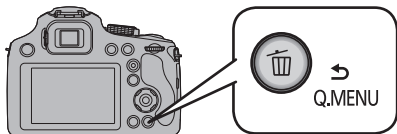

2 Use ▲ ▼ to select [Delete Multi]/[Delete All] and press [MENU/SET]

● [Delete Multi]

Press ▲ ▼ ◀ ▶ to select picture and press [DISP.] button

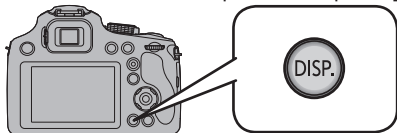

🏠 Picture selected

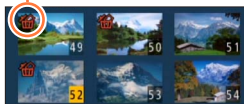

- To cancel → Press [DISP.] button again.
- To execute → Press [MENU/SET].





- You can select [All Delete Except Favorite] in [Delete All] if there are pictures that have been set as [Favorite] (→178).
- A confirmation screen is displayed. When you select [Yes], the selected picture is deleted.
- May take time depending on number of pictures deleted.

Setting the menu

The camera comes with menus that allow you to choose the settings for taking pictures and playing them back as you like. There are also menus that enable you to have more fun with the camera and use it more easily.

In particular, the [Setup] menu contains some important settings relating to the camera's clock and power. Check the settings of this menu before proceeding to use the camera.

■ Menu type

	[Rec] (→142)	You can perform settings such as Aspect Ratio and Picture Size and other settings.
	[Motion Picture] (→157)	You can select the recording format and picture quality and other settings.
	[Setup] (→61)	You can perform settings for convenience of use such as the clock setting and changing of the beep sounds.
	[Playback Mode] (→162)	You can choose the playback method to see [Slide Show] or to narrow down the pictures for display, etc.
	[Playback] (→170)	You can specify picture protection, resizing, print settings, and other settings for pictures you have taken.

Setting menu items

- If you set [Menu Resume] (→72) in the [Setup] menu to [ON], the screen shows the last selected menu item when the menu was closed.

Example: Changing [AF Mode] of [Rec] menu from [□] (1-area-focusing) to [👤] (Face Detection) in [Program AE] Mode.

1 Press [MENU/SET]

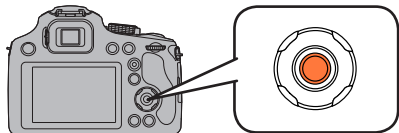

(Continued on the next page)

2 Press ▲ ▼ or rotate the rear dial to select the menu item

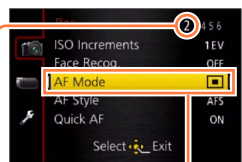
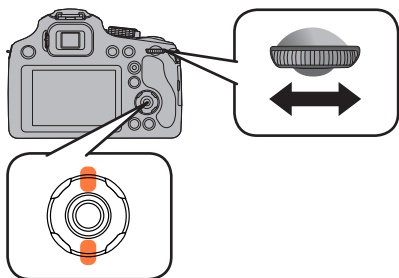

Menu items

Pages
(The pages can also be selected with the zoom lever.)

3 Press ► or the rear dial

4 Press ▲ ▼ or rotate the rear dial to select the settings

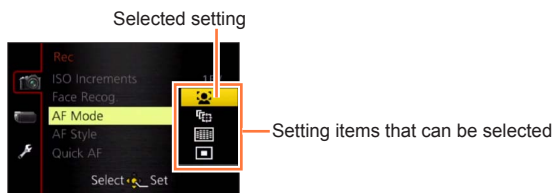

5 Press [MENU/SET] or the rear dial to set

6 Press [MENU/SET] to close the menu

• You can also close the menu by pressing the shutter button halfway.

■ To return to the previous screen

① Press [🗑️ ↶ Q.MENU] button

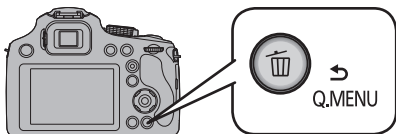

■ Switching to other menus

e.g.: Switching to the [Setup] menu from [Rec] menu

① Press ◀

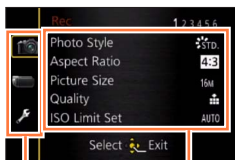

Menu type

Item

② Press ▼ or rotate the rear dial to select the [Setup] menu icon [🔧]

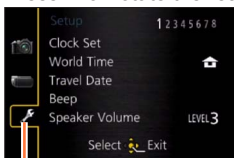

Selected menu type

③ Press ▶ or the rear dial

- The operation screen examples in this manual may differ from the actual screen display or some parts of the screen display are omitted.
- There are functions that cannot be set or used depending on the modes or menu settings being used on the camera due to the specifications.
- The setting methods vary depending on the menu item.
- The following menus are also displayed depending on the recording mode.
 - In the [Intelligent Auto] mode: [Intelligent Auto] menu (→43)
 - In the [Creative Control] mode: [Creative Control] menu (→112)
 - In the [Scene Mode] mode: [Scene Mode] menu (→124)
 - In the [Creative Video Mode] mode: [Creative Video] menu (→132)
 - In the [Custom] mode: [Custom] menu (→135)

Using Quick menu

In recording mode, you can quickly change the main settings of a still picture or a motion picture.

- The menu items and setting items that are displayed differ depending on the recording mode.

1 Press [🗑️ (↪ Q.MENU)] button

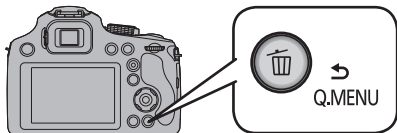

2 Press ◀▶ or rotate the rear dial to select the menu item

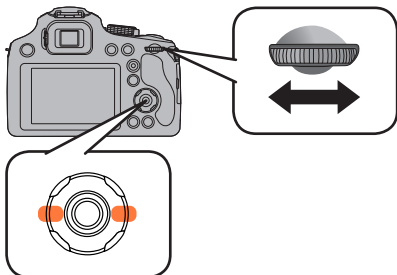

Menu items



3 Press [MENU/SET] or the rear dial to set

4 Press ◀▶ or rotate the rear dial to select the settings

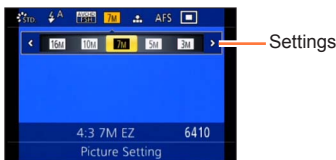

5 Press [MENU/SET] or the rear dial to set

6 Press [🗑️ (↪ Q.MENU)] button

- The menu screen can also be exited by pressing the shutter button halfway.

Using the [Setup] menu

[Clock Set], [Economy] and [Auto Review] are important for clock setting and battery life. Please check these before use.

- For the setting procedures of the menu. (→57)

[Clock Set]

Set time, date, and display format. (→26)

[World Time]

Set the local time at travel destination. (→141)

[Travel Date]

Record the number of days elapsed in your travels. (→140)

[Beep]

Change or mute the beep/shutter sounds.

■ Settings

[Beep Level]

/ / : High / Low / Mute

[Beep Tone]

/ / : Change beep tone.

[Shutter Vol.]

/ / : High / Low / Mute

[Shutter Tone]

/ / : Change shutter tone.

[Speaker Volume]

Adjust volume of sound from speakers (7 levels).

■ Settings: [0] / [1] / [2] / [3] / [4] / [5] / [6]

- Cannot be used to adjust TV speaker volume when connected to TV. Also, when connected, no sound is output from the camera speakers.

- For the setting procedures of the menu. (→57)

[Cust.Set Mem.]

Register the current camera settings. (→134)

[AF/AE LOCK / Fn1]

The operation of the [AF/AE LOCK (Fn1)] button can be switched either to the AF/AE Lock function or to the Fn (function) operation to call up the registered function.

■ Settings

[AF/AE LOCK]	Switches the button to the AF/AE Lock function.
[Fn1]	Switches the button to the Fn (function) operation.

- At the time of purchase, AF/AE Lock is selected.

[Fn Button Set]

Register frequently used functions from the [Rec] menu, [Setup] menu or other menus to the [Fn] button for faster operation. (→107)

[Live View Mode]

Sets the display speed and picture quality of the screen (Live View screen) when recording pictures using the LCD monitor or viewfinder.

■ Settings

[30fps]	Picture quality has higher priority over display speed and pictures are displayed at 30 fps. For example, use when you want to record a comparatively slow-moving subject while confirming the focusing.
[60fps]	Display speed has higher priority over picture quality and pictures are displayed at 60 fps. The displayed pictures will appear slightly grainy. For example, use when you want to record a fast-moving subject.

- The [Live View Mode] setting will have no effect on the pictures being recorded.

- For the setting procedures of the menu. (→57)

[Monitor Display] / [Viewfinder]

Brightness, color, or red or blue tint of the LCD monitor/viewfinder is adjusted.

■ Settings

[Brightness]	Adjust the brightness.
[Contrast · Saturation]	Adjust the contrast or clarity of colors.
[Red Tint]	Adjust the red tint.
[Blue Tint]	Adjust the blue tint.



- ① Press ▲ ▼ to select the setting item and press ◀ ▶ to make adjustments
- ② Press [MENU/SET]



- It will adjust the LCD monitor when the LCD monitor is in use, and the viewfinder when the viewfinder is in use.
- Some subjects may look different from their actual appearance, but the recorded picture will not be affected.

[Monitor Luminance]

These menu settings make it easier to see the LCD monitor when you are in bright places.

■ Settings

 ([Auto Power Monitor])	The brightness is adjusted automatically depending on how bright it is around the camera.
 ([Power Monitor])	The brightness becomes higher than usual for easy viewing outdoors.
[OFF]	—



- Cannot select [] ([Auto Power Monitor]) in playback mode.
- [] ([Power Monitor]) returns to ordinary brightness if there is no operation for 30 seconds when recording. (Press any button to make the screen brighter again.)
- Because the picture shown on the LCD monitor screen emphasizes brightness, some subjects may look different than their actual appearance, but this will not affect the recorded picture.
- Setting [Monitor Luminance] reduces the operating time.

- For the setting procedures of the menu. (→57)

[LVF Disp.Style]

Set the Live View Finder display. (→74)



■ Settings

- : Live View Finder style display layout
- : LCD monitor style display layout

[Monitor Disp. Style]



Set the display of the LCD monitor. (→74)

■ Settings

- : Live View Finder style display layout
- : LCD monitor style display layout





[Guide Line]

Display the guide lines used as a reference for picture composition.

- Settings:  /  /  / [OFF]

■ Setting the position of the guidelines

Select  to set the position of the guidelines.

- ① Select  under [Guide Line] in the [Setup] menu
- ② Press     to move the position of the guidelines (point of intersection) and press [MENU/SET]
 - When you press [DISP.] button, the point of intersection will return to the center.

- In [Panorama Shot] Mode, a dedicated guideline will display to match the recording direction.
This setting can be set to [ON] or [OFF].

- For the setting procedures of the menu. (→57)

[Histogram]

Displays distribution of brightness in picture – e.g. if the graph peaks at the right, this means there are several bright areas in the picture. A peak in the center represents correct brightness (correct exposure). This can be used as a reference for exposure correction, etc.

(Example)

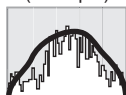

Dark ← OK → Bright

■ Settings: [ON] / [OFF]

- When the histogram is not the same as that of the recorded picture under the following conditions, histogram will be displayed in orange.
 - When manual exposure assist indicates settings other than 0 EV in [Manual Exposure] mode or during Exposure Compensation.
 - When the flash fires.
 - When the proper exposure is not achieved while the flash is closed or the brightness of a picture on the LCD monitor cannot be displayed correctly in dark locations.
- The histogram displayed during recording is only a reference.
- The histogram displayed during recording and that displayed during playback may be different.
- The histogram is different from those displayed using the image editing software of a computer.
- The histogram will not be displayed in the following cases.
 - [Intelligent Auto] Mode
 - Playback Zoom
 - [Creative Video Mode]
 - During motion picture recording
 - Multi Playback
 - When the HDMI mini cable is connected
 - [Calendar]

- For the setting procedures of the menu. (→57)

[Video Rec Area]

Enables verification of the recordable area for a motion picture before recording.

- **Settings:** [ON] / [OFF]



- Recordable area displayed for motion pictures should be interpreted as a guideline.
- Recording area display may disappear when zooming to Tele depending on the picture size setting.
- For [Intelligent Auto] Mode, the setting is fixed to [OFF].

[Remaining Disp.]

Switch the display between the remaining number of still pictures you can take or the remaining recording time of a motion picture that you can record for the available card or built-in memory.

- **Settings**

	Displays the number of pictures that can be recorded.
	Displays the remaining recording time.

[Highlight]

You can set overexposed areas (areas that are too bright and where there are no shades of gray) to flash on the screen when the [Auto Review] function is activated or during playback.

- **Settings:** [ON] / [OFF]

- To reduce overexposed areas, record a picture by setting negative exposure compensation using the histogram display and so on as a reference. (→82) (The right edge of the histogram shows the overexposed portion.)
- This feature is disabled during Multi Playback, [Calendar], Playback Zoom, motion picture playback or automatic scrolling playback of panorama pictures.
- If the subject is too close to the camera when recording using flash, overexposure may occur.

- For the setting procedures of the menu. (→57)

[Expo.Meter]

You can set whether to display the exposure meter when operations such as shutter speed and aperture value adjustments or Exposure Compensation are performed.

- **Settings:** [ON] / [OFF]



Exposure meter

- If the exposure meter is not displayed, press the [DISP.] button to switch the display of the LCD monitor/viewfinder.
- The exposure meter will turn off if no operation is performed for approximately 4 seconds.

[Lens Resume]

- **[Zoom Resume]**

When you turn this unit on, the zoom positions when you last turned this unit off are automatically restored.

- **Settings:** [ON] / [OFF]

- **[MF Resume]**

It will memorize the MF position set with the Manual Focus. It will resume the memorized Manual Focus position when you return to Manual Focus Recording.

- **Settings:** [ON] / [OFF]

- MF position will be memorized in the following cases:
 - Turning the camera off
 - When switching to a type of focus other than Manual Focus
 - When switched to playback mode
- Zoom position will be set all the way to wide when the [Zoom Resume] is set to [OFF].
- When [MF Resume] is set to [OFF], MF position will be the distance focused at the time of recording in Manual Focus.
- Depending on the recording conditions, the memorized MF positions and resumed MF positions might be different. Before you start recording, make sure the subject is in focus.

- For the setting procedures of the menu. (→57)

[MF Assist]

Set whether to enlarge the focus point when Manual Focus is used to adjust focus. (→104)

[Economy]

Turn off the camera or make the LCD monitor go dark while not using the camera to minimize battery consumption.

● [Sleep Mode]

The camera is automatically turned off if the camera has not been used for the time selected on the setting.

- To restore → Press the shutter button halfway, or turn on the power again.

■ **Settings:** [10MIN.] / [5MIN.] / [2MIN.] / [1 MIN.] / [OFF]

- Cannot be used in the following cases:

- When the camera is using AC adaptor (optional) and DC coupler (optional)
- When connected to computer/printer
- During motion picture recording/playback
- During Slide Shows

- Settings fixed to [5MIN.] in [Intelligent Auto] Mode.

● [Auto Monitor Off]

The LCD monitor is automatically turned off if the camera has not been used for the time selected on the setting.

- Press any button to turn on the LCD monitor again.

■ **Settings:** [30 SEC.] / [15 SEC.] / [OFF]

- Cannot be used in the following cases:

- When the camera is using AC adaptor (optional) and DC coupler (optional)
- When connected to computer/printer
- During motion picture recording/playback
- During Slide Shows
- [Intelligent Auto] Mode
- While the Self-timer is set
- While the menu screen is displayed

- [Sleep Mode] is fixed to [2MIN.] when [Auto Monitor Off] is set to [15 SEC.] or [30 SEC.].

- For the setting procedures of the menu. (→57)

[Play on Monitor]

Pictures are automatically played back on the LCD monitor after switching from recording mode to playback mode.

■ Settings

[ON]	Pictures are played back on the LCD monitor.
[OFF]	Pictures are played back on the viewfinder or the LCD monitor depending on which one was used to play back pictures previously.

[Auto Review]

Automatically display still pictures immediately after taking them.

■ Settings

[HOLD]	Keeps the automatic playback screen displayed until [MENU/SET] is pressed.
[2 SEC.] / [1 SEC.]	Displays the playback screen for the set time before automatically returning to the recording screen.
[OFF]	—

- The last picture is automatically reviewed in the following cases.
 - [Auto Bracket]
 - Bracket recording using White Balance
 - [Burst]
- For [Intelligent Auto] Mode, the setting is fixed to [2 SEC.].
- Motion pictures cannot be automatically reviewed.

[No.Reset]

Reset picture file numbers. (The folder number is updated and the file number starts from 0001.)

- To reset folder number to 100:
First, format the built-in memory or card, and reset the file numbers using [No.Reset]. Then, select [Yes] on the folder number reset screen.
- A folder number between 100 and 999 can be assigned.
Numbers cannot be reset once folder number reaches 999. In this case, save all necessary pictures to your computer, and format the built-in memory/card (→73).

- For the setting procedures of the menu. (→57)

[Reset]

Reset to the default settings.



- [Reset Rec. settings?]
- [Reset setup parameters?]

- Information registered in [Face Recog.] is reset if recording settings are reset.
- When [Setup] menu settings are reset, the following settings are also reset.
 - The birthday and name settings for [Baby1]/[Baby2] and [Pet] in Scene Mode.
- Folder numbers and clock settings will not be reset.
- Camera movement may be audible as the lens function is reset. This is not a fault.

[USB Mode]

Select communication method for when connecting camera to a computer or printer with USB connection cable (supplied).

■ Settings

 [Select on connection]	Select communication method each time you connect to a computer or PictBridge-compatible printer.
 [PictBridge(PTP)]	Select when connecting to a PictBridge-compatible printer.
 [PC]	Select when connecting to a computer.

- For the setting procedures of the menu. (→57)

[Output]

Change the settings to be used when the camera is connected to a TV or other device.

- **[TV Aspect]** (This setting performs when an AV cable (optional) is connected.)
 - **Settings:** **16:9** / **4:3**

[VIERA Link]

Enable automatic linking with other VIERA Link-compatible devices, and operability with a VIERA remote control when connecting via an HDMI mini cable (→185).

■ Settings:

[ON]	Operations may be performed via the remote control of the VIERA Link-compatible device. <ul style="list-style-type: none"> • Not all operations will be available. • Operability of the camera's own buttons will be limited.
[OFF]	Operations must be performed via the camera's own buttons.

[3D Playback]

Set how 3D still picture is output.

■ Settings: **[3D]** / **[2D]**



- If you want to play back a picture in 2D (conventional picture) on a 3D television, set to [2D].
- This item of the menu functions when an HDMI mini cable is connected.
- For the procedure for playing back a 3D still picture. (→187)

- For the setting procedures of the menu. (→57)

[Rotate Disp.]

Automatically rotate portrait still pictures.

■ Settings

 ([On])	Rotate pictures on a TV and the LCD monitor/viewfinder so that they are displayed vertically.
 ([External Only])	Pictures are displayed vertically by rotating when played back on TV.
[OFF]	—

- When you play back pictures on a PC, they cannot be displayed in the rotated direction unless the OS or software is compatible with Exif. Exif is a file format for still pictures which allows recording information, etc. to be added. It was established by “JEITA (Japan Electronics and Information Technology Industries Association)”.
- The display is not rotated during Multi Playback.

[Scene Menu]

Set whether or not to display the selection screen for Scene Mode when the camera is switched to Scene Mode.

■ Settings

[AUTO]	Displays the selection screen.
[OFF]	Displays the currently selected Scene Mode recording screen.

[Menu Resume]

Save the last operated menu position.

■ Settings: [ON] / [OFF]

[Version Disp.]

Check the camera firmware version or display software information.

- When you press [MENU/SET] while the version is displayed, software information such as the license is displayed.

- For the setting procedures of the menu. (→57)

[Format]

Use when [Built-In Memory Error] or [Memory Card Error] appears, or when formatting the built-in memory or card.

When a card/built-in memory is formatted, the data cannot be restored. Check the content of the card/built-in memory carefully before formatting.

- To format the built-in memory, remove the card.
(Only inserted card will be formatted if present; built-in memory will be formatted if no card is inserted.)
- **All protected pictures and other picture data will be deleted.**
- This requires a sufficiently charged battery, or an AC adaptor (optional) and DC coupler (optional). Do not turn off power or perform other operations during formatting.
- Always format cards with this camera.
- Formatting the built-in memory may take several minutes.
- If the card cannot be formatted, please try another card before contacting your nearest Service Center.

For USA and Puerto Rico assistance, please call: 1-800-211-PANA(7262) or, contact us via the web at: <http://www.panasonic.com/contactinfo>

For Canadian assistance, please call: 1-800-99-LUMIX (1-800-995-8649).

[Language]

Change display language.

Set the language displayed on the screen.

[Stabilizer Demo.]

Extent of jitter is shown on graph (estimate).

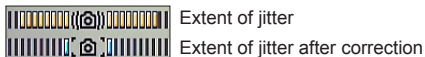

- During demo screen display, the Optical Image Stabilizer switches ON and OFF every time [MENU/SET] is pressed.

Switching the display of recording information, etc.

When you want to check a subject, you can turn off the recording information (such as icons for various settings).

1 Press [DISP.] button to change display

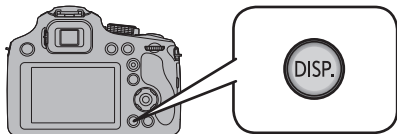

- When the menu screen appears, the [DISP.] button is not activated.
- You can select between [] (viewfinder style) and [] (LCD monitor style) for each of the Viewfinder and the LCD monitor display screen using [LVF Disp.Style] and [Monitor Disp. Style] in the [Setup] menu.

[] (viewfinder style)

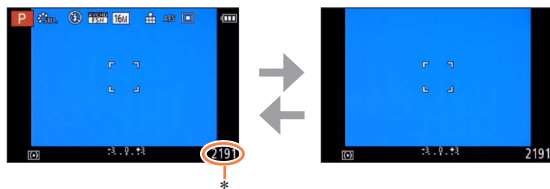

[] (LCD monitor style)

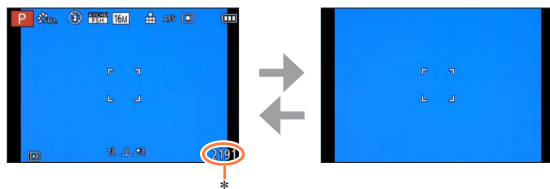

* You can switch between available recording time and number of recordable pictures by setting [Remaining Disp.] in [Setup] menu.

Using Zoom



The zoom lens of this unit allows you to change the focal length from wide-angle, which allows you to record a majestic landscape, to telephoto zoom, which allows you to enlarge a small distant subject. You can also increase the zoom ratio further by changing the setting.

1 Use the zoom lever to adjust the range of the picture to be taken

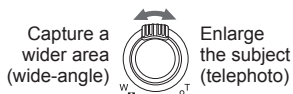
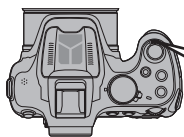

- The zoom speed can be set to one of 2 levels using the angle at which the zoom lever is moved.

The illustration is an example of when using Extended optical zoom, [i.ZOOM], and [Digital Zoom].

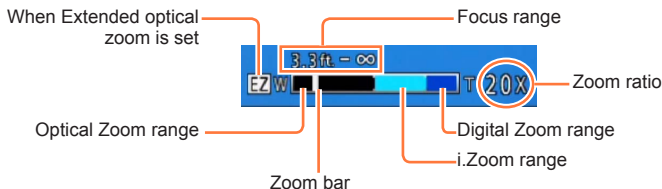

- When [Zoom Resume] in the [Lens Resume] menu is set to [ON], the zoom ratio saved in the memory the last time the camera was turned off is automatically restored when the camera is turned on. (→67)

- Do not touch the lens barrel during zooming.
- Adjust the focus after adjusting the zoom.
- The zoom ratio and the zoom bar displayed on the screen are estimates.
- The camera may make a rattling noise and vibrate when the zoom lever is operated - this is not a malfunction.
- Zoom cannot be used in the following cases:
 - [3D Photo Mode] ([Scene Mode])
 - [Macro Zoom] (Only the Digital Zoom will function up to 3x.)

Enlarging a subject further

The zoom lens of this unit can zoom in up to 60x (optical zoom). If you use the following functions, you can enlarge the subject even further.

■ Extended optical zoom

Zooming in up to 135x is possible when pictures with [EZ] have been selected by [Picture Size] on the [Rec] menu (→143). EZ is short for “Extended optical zoom”.

- Extended optical zoom cannot be used in the following cases:

- Motion picture (including [Creative Video Mode])
- Scene Modes ([HDR], [High Sens.])
- [Creative Control] Mode ([Impressive Art], [Toy Effect])
- When the [Quality] setting is set to [RAW], [RAW] or [RAW]

■ [i.ZOOM]

You can use the camera's Intelligent Resolution technology to increase the zoom ratio up to 2x higher than the original zoom ratio with limited deterioration of picture quality. Set [i.Resolution] to [i.ZOOM] on the [Rec] menu. (→149)

- When [i.Resolution] is set to [i.ZOOM], Intelligent Resolution technology is applied to the picture.
- [i.ZOOM] always functions in [Intelligent Auto] mode and [Scene Mode] (except [Handheld Night Shot], [HDR], [High Sens.]).
- [i.ZOOM] does not function in the following cases.
 - Scene Modes ([Handheld Night Shot], [HDR], [High Sens.])
 - [Creative Control] Mode ([Impressive Art], [Toy Effect])
 - When the [Quality] setting is set to [RAW], [RAW] or [RAW]

■ [Digital Zoom]

Zoom 5x further than Optical/Extended optical zoom. Note that, with Digital Zoom, enlarging will decrease picture quality. Set the [Digital Zoom] in the [Rec] menu to [ON]. (→149)

- Digital Zoom cannot be used in the following modes:
 - [Intelligent Auto] Mode
 - Scene Modes ([Handheld Night Shot], [HDR], [High Sens.])
 - [Creative Control] Mode ([Impressive Art], [Toy Effect], [Miniature Effect])
 - When the [Quality] setting is set to [RAW_{4:4:4}], [RAW_{4:2:0}] or [RAW]
- This is fixed to [ON] when [Macro Zoom] is set.
- When [Digital Zoom] is used simultaneously with [i.ZOOM], you can only increase the zoom ratio up to 2.5x.

■ Example of various zoom function combinations

Uses, etc.	Maximum zoom ratio	Zoom function combinations
When you want to take a picture that has a large image size and maintains sharp resolution to, for example, print a large picture	60x	Optical Zoom
When you want to take a picture that has a large image size and maintains sharp resolution while reducing picture quality degradation	120x	Optical Zoom + [i.ZOOM]
When you want to make the subject larger as you are not going to print a particularly large picture	216x (for 5M size)	Extended optical zoom + [i.ZOOM]
When you want to make a distant subject as large as possible	675x (for 3M size)	Extended optical zoom + [i.ZOOM] + [Digital Zoom]

- When you record pictures using the zoom, jitter often occurs. Record pictures using the following methods to reduce jitter.
 - Use a tripod and self-timer to record pictures.
 - Hold the unit in a stable position and use a viewfinder to record pictures.
 - Increase ISO Sensitivity or use [Shutter-Priority] Mode to record pictures with a faster shutter speed.
- When you record motion pictures using high zoom magnification, jitter may occur for several seconds after recording starts. Using self-timer is effective for preventing jitter of the camera. (→86)

Taking pictures with the built-in flash



You can use the built-in flash to take pictures in dark locations or light up a subject to adjust the contrast of an entire picture when the background is bright.

1 Press [**⚡**] to open the flash

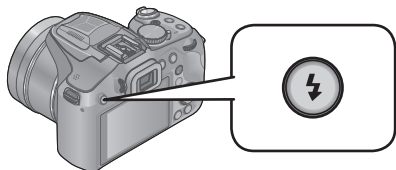

■ Closing the built-in flash

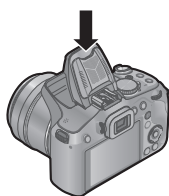

When you do not want to use the flash or after using the flash, press down to retract the flash until it clicks.

- Be sure to close the flash when not in use.

- Be careful not to catch a finger or any other part of your body or any object when you close the flash.
- Be sure to keep the flash clean, clear of dust and avoid exposure to anything sticky. This may cause the flash to stick and not open.
- Do not bring the flash too close to objects or close the flash while it is activated. The objects may be discolored by its heat or lighting.
- Do not close the flash immediately after the preliminary flash is operated prior to taking pictures for Auto/Red-Eye Reduction and other flash settings. If you close the flash immediately, it will cause a malfunction.
- When the flash is being charged, the flash icon flashes red, and you cannot take a picture even when you fully press the shutter button.
- The flash effect may not be sufficient in the following cases:
 - The flash effect may not be sufficient when shutter speed is fast.
 - When [Burst] is set to [**⚡**]
- Flash charging may take time if battery is low or if using flash repeatedly.
- When an External Flash is attached, it will have priority over the built-in flash. (→205)

Changing the setting of the flash

- 1** Select **[Flash]** in the **[Rec]** menu
- For the setting procedures of the menu. (→57)

- 2** Press **▲ ▼** to select a type and press **[MENU/SET]**

Type, operations		Uses
[Auto] • Automatically judges whether or not to flash		Normal use
[Auto/Red-Eye]*2 • Automatically judges whether or not to flash (reduce red-eye)		Taking pictures of subjects in dark places
[Forced Flash On] • Always flash		Taking pictures with backlight or under bright lighting (e.g. fluorescent)
[Slow Sync./Red-Eye]*2 • Automatically judges whether or not to flash (reduce red-eye; slow shutter speed to take brighter pictures)		Taking pictures of subjects against a nightscape (tripod recommended)
[Forced Flash Off] • Never flash		Places where flash use is prohibited

*1 Only in the **[iA]** mode

*2 Two flashes will be emitted. Do not move until after the second flash. Interval between flashes varies according to brightness of subject.

When **[Red-Eye Removal]** in the **[Rec]** menu is set to **[ON]**, the icon changes to /, red-eye is automatically detected and the picture data is corrected. (only if the camera has detected a face)

*3 This setting is not displayed in the menu. When you close the flash, is automatically set.

- You can adjust the intensity of the flash using [Flash Adjust.] in the [Rec] menu. (→153)
- You can use [Flash Synchro] in the [Rec] menu to set whether the first curtain sync or the second curtain sync will be used. (→152)
- The effect of red-eye reduction varies depending on the subject and is affected by factors such as distance to the subject, whether the subject is looking at the camera during preliminary flash, and so on. In some cases, the effect of red-eye reduction may be negligible.
- If light from the flash on a subject is insufficient, neither the proper exposure nor White Balance is achieved.
- When recording with the flash, white saturation can occur if the subject is too close. If [Highlight] of the [Setup] menu is set to [ON], regions of white saturation will blink black and white when you play back or use Auto Review. In this case, we recommend that you adjust [Flash Adjust.] (→153) in the minus direction and record the pictures again.
- Flash is fixed to [☺] when the [Conversion] (→154) is set to [D₇] or [0_□].
- We recommend using an optional external flash when recording a distant subject.

Available types in each mode (○: Available, —: Not available, □: Default setting)

	IA	P A	S M	[Scene Mode]					
	○*1	○	○	○	○	—	□	○	○
	—	○	○	○	—	—	—	○	—
	—	○	○	○	○	—	○	○	○
	—	○	—	—	—	○	—	—	—
	○	○	○	○	○	○	○	○	○

*1 Set to [i[▲]], [i[Ⓢ]], [i[Ⓢ]], or [i[Ⓢ]] depending on the subject and brightness.

- The flash cannot be used when recording motion pictures or in the [▲], [Ⓢ], [Ⓢ], [Ⓢ], [Ⓢ], [Ⓢ], [Ⓢ], and [3D] Scene Modes.

- Flash settings may be changed when changing recording mode.
- Scene Mode flash settings are restored to default when Scene Mode is changed.

The available flash range when [Sensitivity] setting is [AUTO]

Max. Wide	Approx. 0.3 m - 13.5 m (0.98 feet - 44 feet)*2
Max. Tele	Approx. 1.5 m - 6.4 m (4.9 feet - 21 feet)*2

*2 When [ISO Limit Set] is [AUTO].

Shutter speeds for each flash mode

Setting	Shutter speed (seconds)
	1/60*3 - 1/2000th
	1*3 - 1/2000th

*3 When [Sensitivity] is [AUTO]. Varies according to [Min. Shtr Speed] setting.

- In Intelligent Auto Mode, shutter speed changes depending on the identified scene.
- In Scene Mode, the shutter speeds will differ from those described above.

Taking pictures with Exposure Compensation



Corrects the exposure when there is a backlight or when the subject is too dark or too bright.

1 Press the rear dial to set Exposure Compensation to a selected state

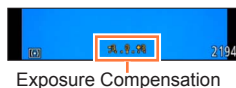
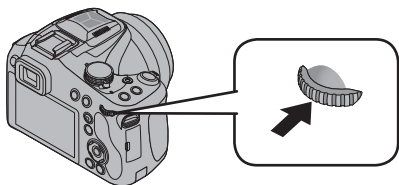

2 Rotate the rear dial to compensate the exposure



Exposure meter

Exposure Compensation value (+3 - -3)

- If the picture is too dark, adjust the exposure to the “+” direction.
- If the picture is too bright, adjust the exposure to the “-” direction.

- Depending on the brightness, this may not be possible in some cases.
- The Exposure Compensation value you set is retained even after the camera is turned off.
- Cannot be set in the following case.
 - [Starry Sky] ([Scene Mode])
- You can adjust the brightness in the following cases.
 - [Intelligent Auto Plus] Mode (→43)
 - [Creative Control] Mode (→112)
 - [Panorama Shot] Mode (→121)

Burst function



A burst of still pictures can be recorded while the shutter button is pressed fully.

1 Press []

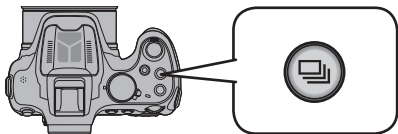





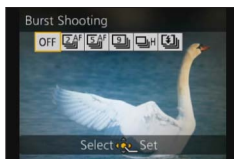





2 Press ▲▼◀▶ to select the burst speed and then press [MENU/SET] (→84)

- Description of recording conditions suitable for each setting is displayed by pressing [DISP.] button.



(Continued on the next page)

■ Settings

Setting	Speed	Description	No. of pictures*1										
 	Approx. 2 pictures/sec.	<ul style="list-style-type: none"> When [] or [] is set, the focus is fixed to the first picture. When [] or [] is set, the focus is adjusted for each picture. The exposure and White Balance are adjusted for each picture. The burst speed may be reduced under certain recording conditions. 	100										
 	Approx. 5 pictures/sec.												
	Approx. 9 pictures/sec.	<ul style="list-style-type: none"> Focus, exposure and White Balance are fixed in the first picture. 	3										
 *2 ([Hi-Speed Burst])	Complies with recording conditions	Speed: Approx. 10 pictures/sec. (Maximum) <ul style="list-style-type: none"> Note on the available picture size settings. <table border="1" data-bbox="363 575 769 725"> <thead> <tr> <th>[Aspect Ratio]</th> <th>Picture size</th> </tr> </thead> <tbody> <tr> <td>4:3</td> <td>3M</td> </tr> <tr> <td>3:2</td> <td>2.5M</td> </tr> <tr> <td>16:9</td> <td>2M</td> </tr> <tr> <td>1:1</td> <td>2.5M</td> </tr> </tbody> </table> <ul style="list-style-type: none"> The number of Burst recording pictures may increase when you use a card with fast writing speed or card is formatted. The focus, exposure, White Balance, shutter speed, and ISO sensitivity are all fixed to the settings for the first picture. 	[Aspect Ratio]	Picture size	4:3	3M	3:2	2.5M	16:9	2M	1:1	2.5M	100
[Aspect Ratio]	Picture size												
4:3	3M												
3:2	2.5M												
16:9	2M												
1:1	2.5M												
 *2 ([Flash Burst])	Complies with recording conditions	<ul style="list-style-type: none"> The burst of still pictures can be recorded even in low light conditions as the flash is used. The focus, exposure, shutter speed, ISO sensitivity, and flash output are all fixed to the settings for the first picture. 	5										
[OFF]	—	The burst function is released.	—										

*1 The number of burst pictures is limited by the picture-taking conditions and the type and/or status of the card used.

*2 Only in [Program AE], [Aperture-Priority] and [Shutter-Priority] modes

- Depending on changes in the brightness of the subject, the second and subsequent pictures may be recorded brighter or darker when using the burst function at the [] setting.
- Burst speed may be reduced if shutter speed is reduced in darker locations.
- [Auto Bracket] or [WB Bracket] is released.
- The flash is set to []. (Except [])
- Settings will be stored even if the camera is turned off.
- When [Self Timer] is set, 3 pictures are taken. (When [] is set, 5 pictures are taken.)
- Depending on the operating conditions, it may take time to take the next picture if you repeat taking a picture.
- It may take a while to store still pictures that were taken using the burst function. If you continue to record while storing, the number of burst pictures that can be taken will be reduced.
- When [AF] or [AF] is set and if you try to take a picture of a subject that is moving fast, you may have trouble with focusing or it may take time to focus.
- You cannot use zoom during burst recording.
- Cannot be set in the following case.
 - [Handheld Night Shot] [HDR] [Starry Sky] [3D Photo Mode] ([Scene Mode])
 - [Toy Effect] [Miniature Effect] [Soft Focus] [Star Filter] ([Creative Control] Mode)
 - When the Self-timer is set to [10s / 3pictures]
- Cannot set to [] in the following cases.
 - When the [Quality] setting is set to [RAW], [RAW] or [RAW]

Taking pictures with self-timer



We recommend using a tripod. This is also effective for preventing jitter when pressing the shutter button or the motion picture button, by setting the self-timer.

1 Press [ON] (▼)

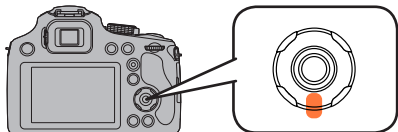

2 Press ▲ ▼ to select the item and then press [MENU/SET]

Item	Description of settings
[10sec.]	Picture is taken 10 seconds after shutter is pressed.
[10s / 3pictures]	After 10 seconds the camera takes 3 pictures at about 2 seconds intervals after shutter is pressed. (Only when taking still pictures)
[2sec.]	Picture is taken 2 seconds after shutter is pressed.
[Off]	—

3 Press the shutter button halfway to focus and then press it fully to take the picture

- The Self-timer indicator blinks and the shutter is activated after 10 seconds (or 2 seconds).
- When [10s / 3pictures] is selected, the Self-timer indicator blinks again after the first and the second pictures are taken and the shutter is activated 2 seconds after it blinks.

■ When taking motion pictures

When motion picture button is pressed, the Self-timer indicator blinks and motion picture recording is started after 10 seconds (or 2 seconds).

- To finish motion picture recording, press motion picture button again.
- When [10s / 3pictures] is set, motion picture recording is started after 10 seconds.



Self-timer indicator

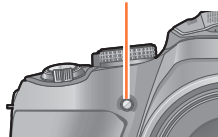

- When you press the shutter button once fully, the subject is automatically focused just before recording. In dark places, the Self-timer indicator will blink and then may turn on brightly operating as an AF Assist Lamp to allow the camera to focus on the subject.
- Depending on the recording conditions, the recording interval may become more than 2 seconds when [10s / 3pictures] is selected.
- It is not possible to set [10s / 3pictures] in the following cases.
 - [Intelligent Auto] Mode
 - [Panorama Shot] Mode
 - [3D Photo Mode] ([Scene Mode])
 - [Creative Video Mode]
 - When using Auto Bracket
 - When using White Balance Bracket
 - During the Burst Mode

Setting the Light Sensitivity



This allows the sensitivity to light (ISO sensitivity) to be set. Setting to a higher figure enables pictures to be taken even in dark places without the resulting pictures coming out dark.

1 Press [ISO] (▲)

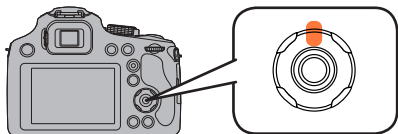

2 Press ▲▼ to select [Sensitivity] and press [MENU/SET]

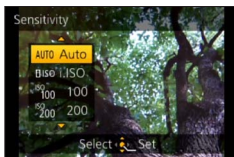

Settings	Description of settings
[AUTO]	The ISO sensitivity is automatically adjusted according to the brightness. • Maximum [1600]*
ISO	The ISO sensitivity is adjusted according to the movement of the subject and the brightness. • Maximum [1600]*
100/200/400/800/ 1600/3200	The ISO sensitivity is fixed to various settings. • When [ISO Increments] is set to [1/3 EV], more ISO Sensitivity settings can be selected. (→145)

	[100]	↔	[3200]
Recording location (recommended)	When it is light (outdoors)		When it is dark
Shutter speed	Slow		Fast
Noise	Less		Increased
Jitter of the subject	Increased		Less

* When the [ISO Limit Set] of [Rec] menu (→145) is set to anything except [AUTO], it is set automatically within the value set in [ISO Limit Set].

■ About [ISO] (Intelligent ISO sensitivity control)

The camera detects movement of the subject and then automatically sets the optimum ISO sensitivity and shutter speed to suit the movement of the subject and brightness of the scene to minimize the jitter of the subject.

- The shutter speed is not fixed when the shutter button is pressed halfway. It is continuously changing to match the movement of the subject until the shutter button is pressed fully.

- For the focus range of flash when [AUTO] is set, refer to (→81).
- The setting is fixed to [AUTO] in the following cases.
 - [Creative Control] Mode
- The setting is fixed to [ISO] in the following cases.
 - [Sports]/[Baby]/[Pet] ([Scene Mode])
- You cannot select [ISO] in Shutter-Priority AE Mode.
- You cannot select [AUTO] or [ISO] in Manual Exposure Mode.
- Setting items below will be selectable in Creative Video Mode.
[AUTO]/[100]/[200]/[400]/[800]/[1600]/[3200]/[6400]
- The shutter speed is determined by the [Sensitivity] setting as shown in the table below.

[Sensitivity] (When the [ISO Increments] (→145) is set to [1/3 EV])	Shutter speed (Sec.)
AUTO/[ISO]	The shutter speed changes automatically according to ISO sensitivity setting.
100/125/160/200/250/320/400	8 to 1/2000
500/640/800	4 to 1/2000
1000/1250/1600	2 to 1/2000
2000/2500/3200	1 to 1/2000

Setting coloring (White Balance)



In sunlight, under incandescent lights or in other such conditions where the color of white takes on a reddish or bluish tinge, this item adjusts to the color of white which is closest to what is seen by the eye in accordance with the light source.

1 Press [WB] (▶)

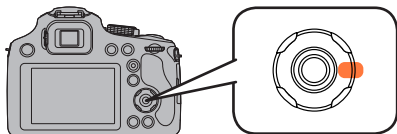

2 Press ▲ ▼ to select the white balance and press [MENU/SET]



■ Settings: [AWB] ([Auto White Balance]) / ☀ ([Daylight]) / ☁ ([Cloudy]) /
 🏠 ([Shade]) / [Flash] ([Flash]) / ☼ ([Incandescent]) /
 [White Set 1] [White Set 2] / [Color Temperature]

- When [AWB] (Automatic White Balance) is set, the coloring is adjusted in accordance with the light source. However, if the scene is too bright or too dark or if other extreme conditions apply, the pictures may appear reddish or bluish. The White Balance may not operate correctly if there is a multiple number of light sources.
- Under fluorescent lighting, LED lighting fixture etc., the appropriate White Balance will vary depending on the lighting type, so use [AWB] or [1] / [2].
- The White Balance might not be adjusted for the subject where the flash does not reach when the flash is used.
- [White Balance] setting is fixed to [AWB] in the following cases:
 - Scene Modes ([Scenery], [Panning], [Night Portrait], [Night Scenery], [Handheld Night Shot], [Food], [Sunset], [Starry Sky])
 - When the picture effect is set to other than [No Effect] in [Panorama Shot] Mode
- Even if the camera's power is off, the set White Balance is remembered. (If the Scene Mode is changed, the white balance setting returns automatically to [AWB].)

■ [AWB] operational range:

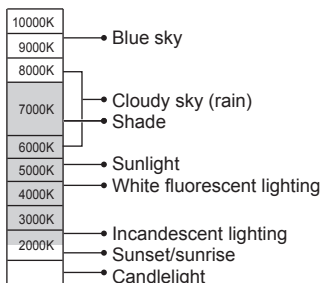

K=Kelvin Color Temperature

Setting the White Balance manually

Take a picture of a white object under the target light source to adjust colors.

1 Press [WB] (▶)

2 Press ▲ ▼ to select either [] or [] and press ▶

3 Point the camera at a white object such as a piece of paper, ensuring that it is inside the frame at the center of the screen, and press [MENU/SET]

• If you want to use a flash, open the flash and set [Flash] in the [Rec] menu to [].

- Even if the camera's power is off, the set White Balance is remembered.
- It may not be possible to set the correct White Balance if subjects are too bright or too dark. In this case, adjust the brightness and try to set the White Balance again.

Setting the White Balance using color temperature

You can set the color temperature manually for taking natural pictures in different lighting conditions.

- 1** Press [WB] (▶)
- 2** Press ▲ ▼ to select [K] and then press ▶
- 3** Press ▲ ▼ to select the color temperature value and press [MENU/SET]
 - You can set the color temperature from 2,500 K to 10,000 K.

Performing White Balance fine adjustments

White Balance settings can be individually fine-tuned if colors still do not appear as anticipated.

- 1** Press [WB] (▶)
- 2** Press ▲ ▼ to select the White Balance fine adjustment setting, and press ▶
 - When you select [1], [2] or [K], press ▶ again.
- 3** Use ▲ ▼ ◀ ▶ to perform fine adjustments and press [MENU/SET]

<ul style="list-style-type: none"> ◀: A (amber: orangish colors) ▲: G+ (green: greenish colors) 	<ul style="list-style-type: none"> ▶: B (blue: bluish colors) ▼: M- (magenta: reddish colors)
---	---

- When you perform fine adjustments of the White Balance toward the A (amber) or B (blue) side, the color of the White Balance icon displayed on the screen will change to the fine-tuned color.
- When you perform fine adjustments of the White Balance toward the G+ (green) or M- (magenta) side, [+] (green) or [-] (magenta) will be displayed in the White Balance icon on the screen.
- When fine adjustments of the White Balance are not performed, select the center point.
- Settings remain applied when using flash.
- You can perform fine adjustments of the White Balance independently for each White Balance setting item.
- Settings are remembered even if the camera is turned off.
- When you reset the White Balance in [1] or [2], or reset the color temperature in [K], the White Balance fine adjustment level will return to the standard setting (center point).

Bracket recording using White Balance

Bracket settings are performed based on the fine adjustment values for White Balance, and three pictures with different coloring are automatically recorded when the shutter button is pressed once.



1 Using the White Balance Fine Adjustment screen, set the White Balance, which is the reference for the bracket

- How to display the White Balance fine adjustment screen ([→92](#))

2 Press [DISP.] button

3 Press ▲ ▼ ◀ ▶ to set the bracket and press [MENU/SET]

- ▲ ▼: G+ (green: greenish colors) to M- (magenta: reddish colors)
- ◀ ▶: A (amber: orangish colors) to B (blue: bluish colors)
- If the bracket width is not set, [WB Bracket] is disabled.

- When [WB Bracket] is set, [BKT] appears on the White Balance icon.
- The position of the bracket cannot exceed the edge (limit value) of the White Balance fine adjustments.
- When White Balance fine adjustments are performed after the bracket is set, the bracket is used to take pictures with the changed adjustment value as the center value.
- When the camera is turned off, the White Balance Bracket setting is canceled. (Including when the camera is turned off by [Sleep Mode])
- The shutter sound will be emitted only once.
- When the White Balance Bracket is set, [Auto Bracket] and [Burst] will be canceled.
- The White Balance Bracket does not function in the following cases.
 - During motion picture recording
 - When the [Quality] setting is set to [RAW , [RAW , or [RAW]

Taking pictures with Auto Focus



When Auto Focus is enabled, press the shutter button halfway to focus. Focusing methods differ depending on recording mode and [AF Mode] setting.

1 Press [AF/AF/MF]

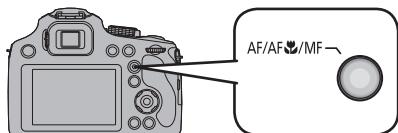

2 Press ▲ ▼ to select [AF] and press [MENU/SET]

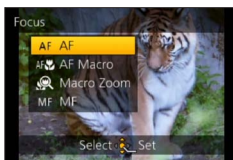

■ Switching [AF Mode]

1 Select [AF Mode] from the [Rec] menu

• For the setting procedures of the menu. (→57)

2 Press ▲ ▼ to select Auto Focus mode items and press [MENU/SET]

(Face Detection)	Taking front-on pictures of people (→96)
(AF Tracking)	Automatically locking the focus on a moving subject (→97)
(23-area-focusing)	Subject not centered in picture (→98)
(1-area-focusing)	Determined position for focus (→98)

Taking front-on pictures of people (Face Detection)

Recognizes faces (up to 15 people) and adjusts exposure and focus accordingly.



AF area

Yellow: When the shutter button is pressed halfway, the frame turns green when the camera is focused.

White: Displayed when more than one face is detected. Other faces that are the same distance away as faces within the yellow AF area are also focused.

- It will be fixed to [👤] (Face Detection) when the [Face Recog.] is set to [ON].
- Cannot set to [👤] (Face Detection) in the following cases:
 - Scene Modes ([Panning] [Night Scenery] [Handheld Night Shot] [Food] [Starry Sky])
 - [Creative Control] Mode ([Miniature Effect] [Soft Focus])
 - [Panorama Shot] Mode
- If the camera misinterprets a non-human subject as a face in [👤] (Face Detection) setting, switch to another setting.
- If conditions prevent the face from being recognized, such as when the movement of the subject is too rapid, the [AF Mode] setting switches to [📏] (23-area-focusing). ([📏] (1-area-focusing) while motion pictures are taken).

Automatically locking the focus on a moving subject (AF Tracking)

1 Bring the subject to the AF tracking frame, and press [AF/AE LOCK (Fn1)] to lock the subject

AF Tracking frame

When the subject is recognized, the AF Tracking frame changes from white to yellow, and the subject is automatically kept in focus.

If AF Lock fails, a red frame flashes.

- To release AF Tracking → Press [AF/AE LOCK (Fn1)].
- Focus range: same as macro recording

- Focus is fixed to [□] (1-area-focusing) during motion picture recording.
- Under certain recording conditions, such as when the subject is small or dark, [AF-ON] (AF Tracking) may not operate correctly.
- Cannot set to [AF-ON] (AF Tracking) in the following cases.
 - [Starry Sky] Scene Mode
 - [Creative Control] Mode ([Sepia] [Dynamic Monochrome] [High Dynamic] [Toy Effect] [Miniature Effect] [Soft Focus])
 - [Creative Video Mode]
 - [Panorama Shot] Mode

Subject not centered in picture (23-area-focusing)

Focuses on the subject in the wide range area (up to 23-area-focusing) on the recording screen.



- Focus is fixed to [1-area] (1-area-focusing) during motion picture recording.
- Cannot set to [23-area] (23-area-focusing) in the following cases.
 - [Creative Video Mode]
 - [Starry Sky] Scene Mode
 - [Miniature Effect] in [Creative Control] Mode

Determined position for focus (1-area-focusing)

Focuses on AF area in center of picture. (Recommended when focus is difficult to align)



- You can adjust the position of the AF area.

- Focus is fixed to [1-area] (1-area-focusing) in the following cases:
 - [Starry Sky] Scene Mode
 - [Miniature Effect] in [Creative Control] Mode

■ Changing the position and size of the AF area

When [AF Mode] is set to [□] (1-area-focusing), you can change the position or size of the AF area at the center.

If you performing any of the following operations, the screen will switch to the settings menu.

- When [□] is selected, press [FOCUS].
- From the menu screen, select [□], and press ►.

1 To change the AF area

To move the AF area: Press ▲▼◀▶

To change the size of the AF area: Rotate the rear dial

- To restore the AF area to its initial state (position and size) → Press [DISP.] button

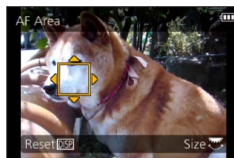

2 Press [MENU/SET]

- The AF area position and size are stored in the memory even when the camera is turned off.
- AF area cannot be moved during motion picture recording.
- When the AF area is small, it may be difficult to adjust the focus.
- When [Metering Mode] is set to [□] (spot-focusing), the new position of the AF area will be measured.
- The position and size cannot be changed in [Miniature Effect] of [Creative Control] mode.

Taking close-up pictures (Macro recording)



When you want to enlarge the subject, setting to [AF Macro] (AF \updownarrow) enables you to take pictures at an even closer distance than the normal focus range (up to 1 cm (0.033 feet) for max. Wide).

1 Press [AF/AF \updownarrow /MF]

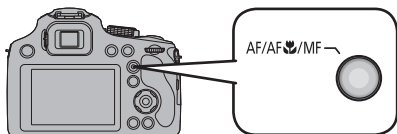

2 Press \blacktriangle \blacktriangledown to select [AF Macro] (AF \updownarrow) and press [MENU/SET]



\updownarrow display

- It may take some time until distant subjects come into focus.
- Using a tripod and [Self Timer] is recommended. Also, when recording a subject that is close to the camera, we recommend that you close the flash to set to [ⓧ].
- If the distance between the camera and the subject is beyond the focus range of the camera, the picture may not be properly focused even if the focus indication lights.
- If the lens becomes dirty with fingerprints or dust, the lens may not be able to focus on the subject correctly.
- Moving the camera after aligning the focus is likely to result in poorly focused pictures if subject is close to the camera, due to the margin for focus alignment being severely reduced.
- Resolution may be reduced around the edges of the picture.
- Cannot be set in the following case.
 - In all Scene Modes except [3D Photo Mode]

Focus range

When a subject is too close to the camera, the picture may not be properly focused. The shortest recording distance differs depending on the zoom ratio and [Focus] setting.

■ Shortest recording distance

The shortest recording distance is the distance from the lens front to the subject. This distance changes gradually depending on the zoom position.

Zoom	[Focus]		
	[AF]	[AF Macro] (AF) (👁)	[Macro Zoom] (👁)
Max. W	30 cm (0.98 feet)	1 cm (0.033 feet)	1 cm (0.033 feet)
Max. T	150 cm (4.9 feet)	150 cm (4.9 feet)	—

- Focus range is displayed when operating the zoom, etc.



[Macro Zoom]



To take even larger images of the subject, setting to [Macro Zoom] (🔍) enables the subject to appear even larger than when using [AF Macro] (AF🌸).

1 Press [AF/AF🌸/MF]

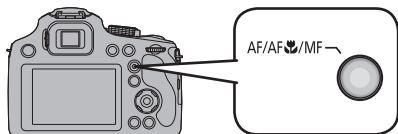

2 Press ▲ ▼ to select [Macro Zoom] (🔍) and press [MENU/SET]

3 Adjust the magnification with the zoom lever

- The zoom position is fixed at the Wide end. Focus range is 1 cm (0.033 feet) - ∞.

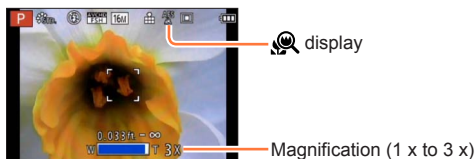
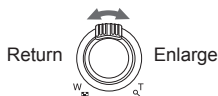

- In [Macro Zoom], higher magnification results in lower picture quality.
- When [Macro Zoom] is set, Extended optical zoom or [i.ZOOM] does not work.
- When [AF Tracking] is set, zoom macro is canceled.
- Cannot be set in the following case.
 - [Impressive Art] [Toy Effect] [Miniature Effect] ([Creative Control] Mode)
- When [Conversion] is set, the [Macro Zoom] cannot be set.

Taking pictures with Manual Focus



Manual Focus is convenient when you want to lock the focus to take pictures or when it is difficult to adjust focus using Auto Focus.

1 Press [AF/AF/MF]

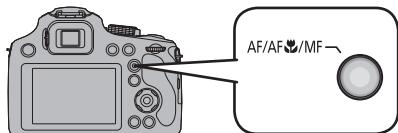

2 Press ▲ ▼ to select [MF] and press [MENU/SET]

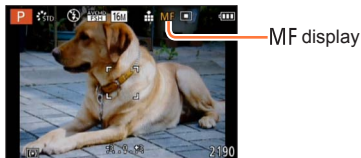

3 Press the rear dial to set [MF] to a selected state

- Enabled operation will switch every time the rear dial is pressed.

4 Rotate the rear dial to focus on the subject

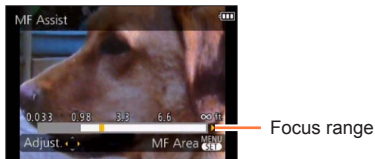

- Using the cursor button is recommended when making slight adjustments.
- When you stop operating the focus adjustment, the focus range will disappear after a few seconds.

- After you use the zoom function or cancel [Sleep Mode], adjust the focus again.
- The focus range displayed by Manual Focus is a reference value. Confirm the focus on the screen ([MF Assist] screen).

MF assist

When [MF Assist] in the [Setup] menu is [ON] and you perform the Manual Focus operation, an enlarged display appears.

- Shortly after you stop operating Manual Focus, the display switches to normal.
- To change the position of an enlarged display
 - ① Press [MENU/SET] while MF assist is displayed
 - ② Press ▲▼◀▶ to move the enlarged display
 - The magnification of the enlarged area can be changed by pressing the rear dial when MF Assist is activated or the MF area is moving.
 - To return to the original position → Press [DISP.] button
 - ③ Press [MENU/SET]

- The MF Assist is disabled in the Digital Zoom range or when recording motion pictures.
- The MF Area position is retained even after the unit is turned off.

Technique for Manual Focus

- ① Focus by rotating the rear dial
- ② Press the cursor button a few times furthermore in the same direction
- ③ Finely focus on the subject by pressing the cursor button in reverse



Prefocus

This is a technique for focusing in advance on the point the pictures will be taken when it is difficult to focus on the subject with Auto Focus due to its quick motion. (e.g. [Panning] in Scene Mode)

This function is suitable when the distance between the camera and the subject is certain.

One shot AF

You can focus on the subject with Auto Focus by pressing [FOCUS] button during Manual Focus. This is convenient for prefocus.

Taking pictures by locking the focus and/or exposure [AF/AE LOCK]



The AF/AE Lock function is convenient, for example, when there is too much contrast with the subject and you cannot get appropriate exposure (AE Lock) or when you want to take a still picture composed with the subject outside the AF area (AF Lock).

1 Align the AF area with the subject

2 Press [AF/AE LOCK (Fn1)] button to lock the focus and/or exposure

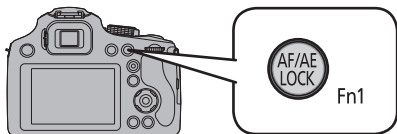

- To cancel AF/AE Lock → Press [AF/AE LOCK (Fn1)] button

3 Move the camera to compose the still picture you want to take, and press the shutter button fully

- When AE is set, press the shutter button halfway to focus, then press it fully.

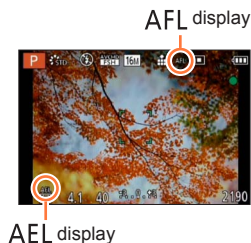

■ AF/AE Lock switching

By using [AF/AE Lock] in the recording menu, you can set whether to lock focus and/or exposure.

[AF]	Only the focus is locked. • [AFL] is displayed when the subject comes into focus.
[AE]	Only the exposure is locked. • [AEL], aperture value, and shutter speed are displayed when the exposure is adjusted.
[AF/AE]	Both focus and exposure are locked. • [AFL], [AEL], aperture value and shutter speed are displayed when the focus and the exposure are optimized.

- To use as the [AF/AE LOCK] button, set [AF/AE LOCK / Fn1] in the [Setup] menu to [AF/AE LOCK]. (→62)
- AF Lock only is effective in the following cases.
 - [Manual Exposure] Mode
 - [Panorama Shot] Mode
 - [Scene Mode]
- During Manual Focus, only AE Lock can be used.
- Lock is canceled when zooming is performed after locking.
- When AE lock is performed, the brightness of the recording screen that appears on the LCD monitor/Viewfinder is fixed.
- Under [Program AE] Mode, program shift can be operated even after AE Lock is set.
- About recording motion pictures
 - Lock is released when recording motion picture is started except when recording in [Creative Video Mode].
 - Under [Creative Video Mode], lock is also effective during motion picture recording. (However, lock is released when zoom operation is performed).
 - Lock operations cannot be performed during motion picture recording.

Using the function button

You can assign the recording function, etc. to the function buttons. Press the buttons to instantly access assigned functions.

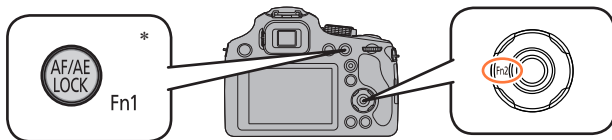

* To use as the function button, set [AF/AE LOCK / Fn1] in the [Setup] menu to [Fn1]. (→62)

- 1** Select [Fn Button Set] from the [Setup] menu (→57)
- 2** Press ▲ ▼ to select the button to assign and then press [MENU/SET]
- 3** Press ▲ ▼ to select the function to assign and then press [MENU/SET]

■ Settings: [Fn1 Button Set] / [Fn2 Button Set]

■ Functions that can be registered

[Photo Style] (→142)	[Guide Line] (→64)
[Aspect Ratio] (→143)	[Video Rec Area] (→66)
[Quality] (→144)	[Remaining Disp.] (→66)
[Metering Mode] (→148)	[Flash] (→79)
[AF Mode] (→95)	[Flash Adjust.] (→153)
Focus [AF Style] (→146)	[Auto Bracket] (→155)
[i.Dynamic] (→148)	

- The function assigned to the [Fn2] button will not work in the following cases.
 - [Miniature Effect] [One Point Color] ([Creative Control] Mode)
- When [AF Mode] is [Tracking] ([AF Tracking]), the [AF/AE LOCK (Fn1)] button will not work as a function button. (It will work as a selection switch for AF Tracking lock/cancel.)

Taking pictures by setting the aperture value

[Aperture-Priority] Mode



When recording, you can control the aperture value to meet your recording purposes. Shutter speed is automatically adjusted to be appropriate for the set aperture value.

1 Set mode dial to [A]

2 Rotate the rear dial to set the aperture value

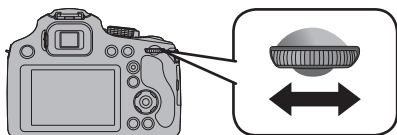

About the exposure meter

Shutter speed
(Automatic adjustment)

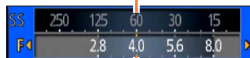

Set aperture value

- Proper exposure is not possible in the range indicated in red.

- When the aperture value is increased, the range of depth in focus expands, and the picture shows up clearly from the position of the camera to the background.
- When the aperture value is reduced, the range of depth in focus shrinks, and the background can get blurry.

Aperture values that can be set* (Per 1/3 EV)	Shutter speed set (seconds)
F2.8 - F8.0	8 - 1/2000

* Some aperture values are not selectable when using conversion lens. Depending on the zoom position, some of the values cannot be selected.

- When the picture is too bright or too dark or there is incorrect exposure, the numbers for the aperture value and shutter speed are shown in red.
- The brightness of the LCD monitor/Viewfinder and the recorded pictures may differ. Check the pictures on the playback screen.
- Set the aperture value to a higher number when the subject is too bright. Set the aperture value to a lower number when the subject is too dim.
- The lower limit of shutter speed differs depending on ISO Sensitivity.

Taking pictures by setting the shutter speed

[Shutter-Priority] Mode



When recording, you can control the shutter speed to meet your recording purposes. Aperture is automatically adjusted to be appropriate for the set shutter speed.

1 Set mode dial to [S]

2 Rotate the rear dial to set the shutter speed

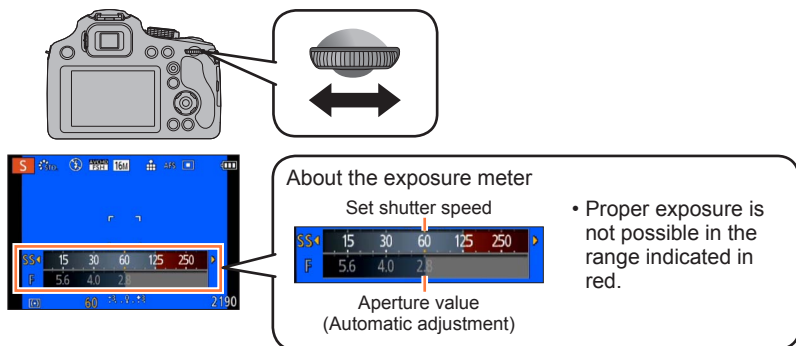

- When you increase the shutter speed, you can reduce jitter when recording a subject.
- When you decrease the shutter speed, the subject's movement is shown.

Shutter speeds that can be set (seconds) (Per 1/3 EV)	Aperture value set
8* - 1/2000	F2.8 - F8.0

* ISO Sensitivity may be changed depending on the shutter speed that you set. (→89)

- When the picture is too bright or too dark or there is incorrect exposure, the numbers for the aperture value and shutter speed are shown in red.
- The brightness of the LCD monitor/Viewfinder and the recorded pictures may differ. Check the pictures on the playback screen.
- Display of the shutter speed will count down when the shutter speed is set to slow and the shutter button is pressed all the way. (Depending on shutter speed settings, count down for processing may be displayed again after this.)
- We recommend using a tripod when the shutter speed is slow.
- The [Sensitivity] is automatically set to [AUTO] when you switch the Recording Mode to Shutter-Priority AE Mode while the [Sensitivity] is set to [ISO].

Taking pictures by setting the aperture value and shutter speed [Manual Exposure] Mode



You can use this recording mode to set the desired shutter speed and aperture value when you want to take pictures using the same exposure (same combination of shutter speed and aperture value) or when you cannot obtain pictures at the desired brightness even after compensating the exposure.

1 Set mode dial to [M]

- Manual exposure assist is displayed.

2 Rotate the rear dial to set the aperture and shutter speed

- It will switch between aperture setting operation and shutter speed setting operation every time the rear dial is pressed.

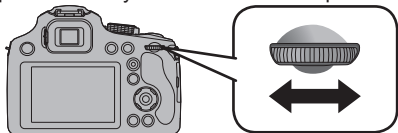

Manual exposure assist
(→111)

About the exposure meter

Set shutter speed



Set aperture value

- Proper exposure is not possible in the range indicated in red.

Aperture values that can be set*1 (Per 1/3 EV)	Shutter speeds that can be set (seconds) (Per 1/3 EV)
F2.8 - F8.0	8*2 - 1/2000

*1 Some aperture values are not selectable when using conversion lens. You may not be able to select some values depending on zoom position.

*2 ISO Sensitivity may be changed depending on the shutter speed that you set. (→89)

Taking pictures by setting the aperture value and shutter speed [Manual Exposure] Mode

■ Manual exposure assist (estimate)



	Shows pictures with standard brightness.
	Shows brighter pictures. For standard brightness, either use a faster shutter speed or increase aperture value.
	Shows darker pictures. For standard brightness, either use a slower shutter speed or reduce aperture value.

- When the picture is too bright or too dark or there is incorrect exposure, the numbers for the aperture value and shutter speed are shown in red.
- The brightness of the LCD monitor/Viewfinder and the recorded pictures may differ. Check the pictures on the playback screen.
- Display of the shutter speed will count down when the shutter speed is set to slow and the shutter button is pressed all the way. (Depending on shutter speed settings, count down for processing may be displayed again after this.)
- We recommend using a tripod when the shutter speed is slow.
- The [Sensitivity] is automatically set to [100] when you switch the recording mode to [Manual Exposure] Mode while the [Sensitivity] is set to [AUTO] or [iiso].

Taking pictures with different picture effects

[Creative Control] mode



You can select your own settings from various effects and take pictures while confirming these effects on the LCD monitor.

1 Set mode dial to [Creative Control]

2 Press ▲ ▼ to select an effect, and then press [MENU/SET]

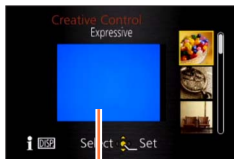

Preview screen

- If you press the [DISP.] button, an explanation of the effect appears.
- When you select [Creative Control] by rotating the mode dial, the menu appears automatically.
- You can display the [Creative Control] menu by pressing [MENU/SET]. For the setting procedures of the menu. (→57)

- The flash is set to [Flash Off].
- The display of a picture reflecting a selected effect in the preview screen or recording screen may differ from the actual recorded pictures.
- A setting that was selected in [Creative Control] mode is retained even after the camera is turned off.
- The following menu settings are fixed.
 - [White Balance]: [AWB]
 - [Sensitivity]: [AUTO]

■ Adjusting the brightness, background defocusing condition, setting conditions of a selected effect, etc.

1 Press the rear dial

- The adjustment screen is displayed.

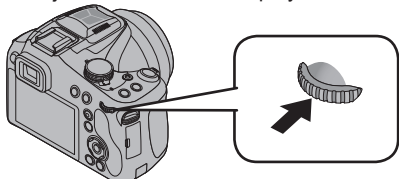

2 Press ▲▼ to select an item to adjust

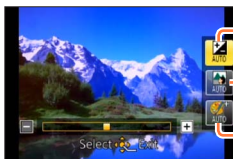

Adjusts the brightness.

Adjusts background defocusing.

Adjusts the setting conditions of the selected effect, etc. (The settings to be adjusted vary depending on the selected effect.)

- [AUTO] is displayed in the icon during automatic adjustment.
- The items that can be adjusted differ depending on the selected effect.

3 Press ◀▶ to make adjustments

- You can also rotate the rear dial to make adjustments.
- To return to automatic adjustment → Press [Q.MENU] button.

4 Press [MENU/SET]

- You can also press the rear dial to finalize the setting.

- When you record motion pictures, the camera performs aperture control within the appropriate exposure range, and the background defocusing may not change for some subject brightness levels.
- The adjustment range of the background defocusing condition will change according to the zoom position.

For the [Creative Control] menu setting procedures. (→112)

[Expressive]

This picture effect creates a pop art style picture that enhances the color.

■ Items that can be set (→113)

Brightness	Underexposure (darker)	↔	Overexposure (brighter)
Degree of background defocusing	Defocuses the background	↔	The background is in focus as well
Vividness	Subdued coloring	↔	Gaudy coloring

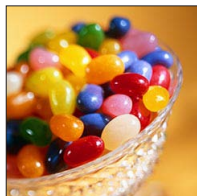

[Retro]

This picture effect creates the soft appearance of a tarnished picture.

■ Items that can be set (→113)

Brightness	Underexposure (darker)	↔	Overexposure (brighter)
Degree of background defocusing	Defocuses the background	↔	The background is in focus as well
Coloring	Yellowish coloring	↔	Reddish coloring

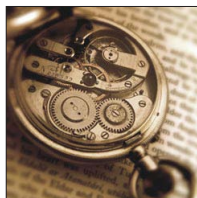

[Old Days]

This effect adds a bright, soft and nostalgic feel to the overall image.

■ Items that can be set (→113)

Brightness	Underexposure (darker)	↔	Overexposure (brighter)
Degree of background defocusing	Defocuses the background	↔	The background is in focus as well
Contrast	Low contrast	↔	High contrast



For the [Creative Control] menu setting procedures. (→112)

[High Key]

This picture effect creates a brighter and lighter toned appearance for the entire picture.

■ Items that can be set (→113)

Brightness	Underexposure (darker)	↔	Overexposure (brighter)
Degree of background defocusing	Defocuses the background	↔	The background is in focus as well
Coloring	Pinkish coloring	↔	Light-bluish coloring

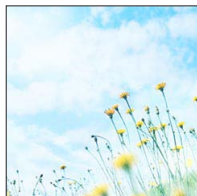

[Low Key]

This picture effect creates a darker somber appearance for the entire picture to emphasize the bright portions.

■ Items that can be set (→113)

Brightness	Underexposure (darker)	↔	Overexposure (brighter)
Degree of background defocusing	Defocuses the background	↔	The background is in focus as well
Coloring	Reddish coloring	↔	Bluish coloring

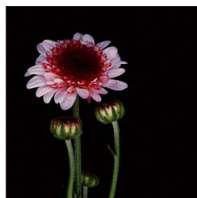

[Sepia]

This picture effect creates a picture with sepia tone.

■ Items that can be set (→113)

Brightness	Underexposure (darker)	↔	Overexposure (brighter)
Degree of background defocusing	Defocuses the background	↔	The background is in focus as well
Contrast	Low contrast	↔	High contrast



For the [Creative Control] menu setting procedures. (→112)

[Dynamic Monochrome]

This picture effect creates a monochromatic picture with a higher contrast and more dramatic atmosphere.

■ Items that can be set (→113)

Brightness	Underexposure (darker)	↔	Overexposure (brighter)
Degree of background defocusing	Defocuses the background	↔	The background is in focus as well
Contrast	Low contrast	↔	High contrast



[Impressive Art]

A picture effect with strong contrast that illustrates a surreal and dramatic atmosphere.

■ Items that can be set (→113)

Brightness	Underexposure (darker)	↔	Overexposure (brighter)
Degree of background defocusing	Defocuses the background	↔	The background is in focus as well
Vividness	Black & white	↔	Gaudy coloring



[High Dynamic]

This picture effect creates a picture with a well-balanced brightness for the entire picture (from dark areas to bright areas).

■ Items that can be set (→113)

Brightness	Underexposure (darker)	↔	Overexposure (brighter)
Degree of background defocusing	Defocuses the background	↔	The background is in focus as well
Vividness	Black & white	↔	Gaudy coloring



For the [Creative Control] menu setting procedures. (→112)

[Cross Process]

This picture effect creates a unique atmosphere with surprising colors.

■ Items that can be set (→113)

Brightness	Underexposure (darker)	↔	Overexposure (brighter)
Degree of background defocusing	Defocuses the background	↔	The background is in focus as well
Coloring	Greenish coloring / Bluish coloring / Yellowish coloring / Reddish coloring		



[Toy Effect]

This picture effect creates a picture that resembles pictures taken by a toy camera with a reduced amount of peripheral light.

■ Items that can be set (→113)

Brightness	Underexposure (darker)	↔	Overexposure (brighter)
Degree of background defocusing	Defocuses the background	↔	The background is in focus as well
Coloring	Orangish coloring	↔	Bluish coloring



For the [Creative Control] menu setting procedures. (→112)

[Miniature Effect]

This effect blurs peripheral areas to give the impression of a diorama.

■ Items that can be set (→113)

Brightness	Underexposure (darker)	↔	Overexposure (brighter)
Vividness	Subdued coloring	↔	Gaudy coloring



■ Defocusing a picture

- ① Press [Fn2] button (◀)
- ② Press ▲ ▼ or ◀ ▶ to move the focusing area (frame)
- ③ Rotate the rear dial to select the size of the focusing area (frame)
- ④ Press [MENU/SET]
 - When you press [DISP.] button, the initial setting condition is restored.

- The recording screen is displayed like a frame dropping with a slight delay compared to normal recording.
- Portrait orientation recording does not affect the blurred part. (The left and right edges will be blurred.)
- No audio is recorded for motion pictures.
- When a motion picture is recorded, the finished recording will be approximately 1/10th of the actual recorded time period. (If you record a motion picture for 10 minutes, the resulting motion picture recording time will be approximately 1 minute.) The recordable time displayed on the camera is approx. 10x longer than actual time needed for recording. When the recording mode is changed, be sure to check the recordable time.
- If you stop recording motion pictures too soon, the camera may continue recording until a certain time. Hold the camera until the camera stops recording.
- When you take a picture using a large picture size setting, the screen will become dark for a certain period of time after the picture is taken. However, this occurs due to signal processing and is not a defect.

For the [Creative Control] menu setting procedures. (→112)

[Soft Focus]

This picture effect creates a soft appearance by intentionally blurring the entire picture.

■ Items that can be set (→113)

Brightness	Underexposure (darker)	↔	Overexposure (brighter)
Degree of background defocusing	Defocuses the background	↔	The background is in focus as well
Degree of defocusing	Slight defocusing	↔	Strong defocusing



- The recording screen is displayed like a frame dropping with a slight delay compared to normal recording.

[Star Filter]

This picture effect creates a picture with the light from the light source that shines in the shape of a cross, creating a gorgeous atmosphere.

■ Items that can be set (→113)

Brightness	Underexposure (darker)	↔	Overexposure (brighter)
Degree of background defocusing	Defocuses the background	↔	The background is in focus as well
Length of the rays of light	Rays of light is short	↔	Rays of light is long



- The recording screen is displayed like a frame dropping with a slight delay compared to normal recording.

For the [Creative Control] menu setting procedures. (→112)

[One Point Color]

This picture effect creates a monochromatic picture by retaining the color you selected only, and adds memorable emphasis to it.

■ Items that can be set (→113)

Brightness	Underexposure (darker)	↔	Overexposure (brighter)
Degree of background defocusing	Defocuses the background	↔	The background is in focus as well
Amount of color retained	Leaves a small amount of color	↔	Leaves a large amount of color



■ Selecting color

- ① Press [Fn2] button (◀)
- ② Select the color to be retained using the frame in the center of the screen and press [MENU/SET]

- The selected color may not be retained for some subjects.

Recording panorama pictures [Panorama Shot] Mode



You can easily record a panorama picture by panning the camera towards the direction you want to record, and automatically combining the burst of pictures taken during that time.

1 Set mode dial to []

- The recording direction is set as “left → right” and the picture effect is set to [No Effect] at the time of purchase.

2 Press the shutter button halfway to focus

3 Press the shutter button fully and pan the camera in a small circular motion to the recording direction to start recording

- Taking pictures from left to right

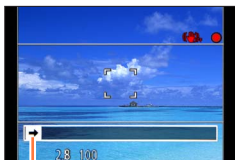

Recording direction and progress status (approximate)

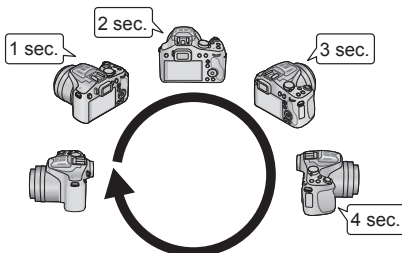

- Pan the camera so that you make a complete circuit in approx. 8 seconds
 - Pan the camera at a constant speed.
 - You may not be able to take pictures successfully if you move the camera too quickly or too slowly.
 - Pan the camera in a small circular motion.

4 Press the shutter button fully again to end recording

- You can also end recording if you stop panning the camera while taking pictures.

■ Tips

- Pan the camera in the recording direction as steadily as possible. If the camera shakes too much, it may not be able to take pictures or may end up creating a narrow (small) panorama picture.



Pan the camera to a point slightly ahead of the point that you want to take. (However, the last frame is not recorded to the end.)

Setting the recording direction and picture effect

You can change the recording direction, or add picture effect same as in [Creative Control] mode to take panorama pictures.

1 Press ▲ (in [Panorama Shot] Mode)

2 Press ▲ ▼ to select the recording direction and then press [MENU/SET]



3 Press ▲ ▼ to select the picture effect and press [MENU/SET]

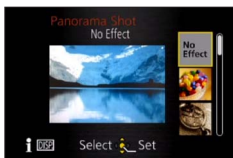

- Use the same operations as in [Creative Control] Mode to add picture effects. (you cannot select [Toy Effect] or [Miniature Effect]) For details on effects (→114 - 120)
- If you do not want to add picture effects, please select [No Effect].

■ Adjusting the brightness, background defocusing condition, setting conditions of a selected effect, etc.

Press the rear dial to display the adjustment screen. (→113)

- The zoom position is fixed to the W end.
- [Stabilizer] does not work.
- The focus, exposure and White Balance are all fixed to optimal values for the first picture.
If the focusing or brightness of pictures recorded as part of a Panorama picture after the first picture are significantly different from those of the first picture, the Panorama picture as a whole (when all pictures are stitched together) may not have consistent focus and brightness.
- [White Balance] cannot be set when applying picture effects.
- Since several pictures are stitched together to create a Panorama picture, some subjects may be distorted or the joining portions of successively taken pictures that are stitched may be noticeable.
- The number of recording pixels per horizontal line and vertical line of a Panorama picture varies depending on the recording direction and number of stitched pictures. The maximum number of recording pixels is as follows:
 - Taking pictures in landscape orientation: Approx. 8000 x 1080
 - Taking pictures in portrait orientation: Approx. 1440 x 8000
- Panorama pictures may not be created or pictures may not be recorded properly when taking pictures of the following subjects or when taking pictures in the following recording conditions:
 - Subjects that have a continuous monotone or pattern (sky, beach, etc.)
 - Moving subjects (person, pet, vehicle, waves, or flowers swaying in the wind, etc.)
 - Subjects whose colors or patterns change quickly (such as an image appearing on a display)
 - Dark locations
 - Locations with a flickering light source (fluorescent lamp, candle light, etc.)
- When set to [High Key], the effect may be difficult to see, depending on the brightness of the subject.
- When set to [Impressive Art], stitches may stand out.
- While recording with [Soft Focus] [Star Filter], you cannot see the effects on the LCD monitor or viewfinder.
- Settings will be stored even if the camera is turned off.

■ About panorama playback

Panorama pictures can be enlarged by operating the zoom lever the same way as with other still pictures. (→50) If you play back panorama pictures in the same way as playing back a motion picture, the panorama pictures are scrolled automatically. (→53)

- Unlike motion picture playback, you cannot perform fast forward or fast rewind while the panorama pictures are scrolling automatically. (You can perform single-frame forward or rewind while the automatic scrolling operation is paused.)

Taking pictures according to the scene [Scene Mode]



Using [Scene Mode] enables you to take pictures with optimum settings (exposure, coloring, etc.) for given scenes.

1 Set mode dial to [SCN]

2 Press ▲▼◀▶ to select the Scene Mode and then press [MENU/SET]



- If you press the [DISP.] button, an explanation of the scene mode appears.
- When you select [SCN] by rotating the mode dial, the menu appears automatically. (When [Scene Menu] in the [Setup] menu is [AUTO])
- You can display the [Scene Mode] menu by pressing [MENU/SET]. For the setting procedures of the menu. (→57)

- Selecting a Scene Mode inappropriate for the actual scene may affect the coloring of your picture.
- When [Conversion] of [Rec] menu is set to [D₇] or [0_□], [Handheld Night Shot] and [3D Photo Mode] Scene Mode cannot be selected.

- How to select a scene (→124)

[Portrait]

Improves the skin tone of subjects for a healthier appearance in bright daylight conditions.

■ Tips

- The more the zoom is drawn towards T side and a distant background is selected, the greater the effect will be.

[Soft Skin]

Smooths skin colors in bright, outdoor daylight conditions (portraits from chest upwards).

■ Tips

- The more the zoom is drawn towards T side and a distant background is selected, the greater the effect will be.

- If a part of the background etc. is a color close to skin color, this part is also smoothed.
- This mode may not be effective when there is insufficient brightness.

[Scenery]

Takes clear pictures of wide, distant subjects.

[Sports]

Takes pictures of scenes with fast movement, e.g. sports.

■ Tips

- Stand at least 5 m (16 feet) away.
- Shutter speed may slow down up to 1 second.

- How to select a scene (→124)

[Panning]

When you move the camera to follow a subject moving in one direction such as a runner or car, the background becomes a blur and the subject stays focused. This effect is called “panning”. This mode allows you to obtain this effect easier.

1 Press ▲▼ to select shutter speed setting, and then press [MENU/SET]

■ Settings

[Auto]	The shutter speed is set automatically.
[Shutter-Priority]	As in [Shutter-Priority] mode (→109), you can rotate the rear dial to set the shutter speed at which to record pictures. Note, however, that you can set the shutter speed only within the range in which a panning technique will have an effect.

■ Technique for Panning Mode

To obtain good pictures in Panning Mode, move the camera in a horizontal plane as you take the pictures.

- We recommend that you do not follow the subject with the camera alone, but stand facing the subject with shoulders squared, and follow it using your entire body, while twisting at the waist.
- Once the subject is in front of you, press the shutter button. Do not stop moving the camera even after you press the shutter button.

- ① Move the camera smoothly while following the subject in the viewfinder
- ② Press the shutter button while you are moving the camera
- ③ Move the camera continuously

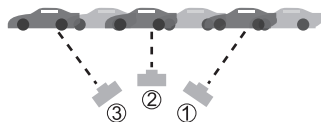

- We recommend the following:
 - Using the Viewfinder.
 - Selecting a subject with quick motion.
 - Using autofocus.
 - Use this mode with Burst Mode. (You can then select the best pictures from all the pictures taken.)

- The shutter speed in Panning Mode becomes slower to achieve the panning effect. As a result, jitter can easily occur.

- How to select a scene (→124)

[Night Portrait]

Takes pictures of people and nightscapes with close to actual brightness.

■ Tips

- Use flash.
 - Ask the subject not to move while taking a picture.
 - Tripod, self-timer recommended.
- Shutter speed may slow down up to 8 seconds.
 - After recording, the shutter may stay closed (up to 8 seconds) to process the signal. This is not a malfunction.
 - Noise may become visible when you take pictures in dark places.

[Night Scenery]

Takes clear pictures of night scenes.

■ Tips

- Tripod, self-timer recommended.
- Shutter speed may slow down up to 8 seconds.
 - After recording, the shutter may stay closed (up to 8 seconds) to process the signal. This is not a malfunction.
 - Noise may become visible when you take pictures in dark places.

- How to select a scene (→124)

[Handheld Night Shot]

Takes clear still pictures of night scenes with less jitter and less noise by combining a burst of still pictures.

■ Tips

- After the shutter button has been pressed, do not move the camera during the burst operation.
- Stand at least 5 m (16 feet) away.

- Noise may become visible when you take pictures in dark places or take pictures of moving subjects.

[HDR]

The camera can combine several still pictures taken with different exposures into a single properly exposed picture with rich gradation. The individual pictures used to create the HDR picture are not saved. You can minimize the loss of gradations in bright areas and dark areas when, for example, the contrast between the background and the subject is large.

■ What is HDR?

HDR stands for High Dynamic Range and refers to a technique for expressing a wide contrast range.

■ Tips

- After the shutter button has been pressed, do not move the camera during the burst operation.

- Since a burst of still pictures are combined after they have been recorded, it will be a few moments before you will be able to record another picture.
- A subject that was in motion when it was recorded may be recorded as an afterimage.
- The camera may take a single still picture instead of several pictures under certain recording conditions.

[Food]

Takes natural-looking pictures of food.

- How to select a scene (→124)

[Baby]

This takes pictures of a baby with a healthy complexion. When you use the flash, the light from it is weaker than usual.

■To record age and name

[Baby1] and [Baby2] can be set separately.

1 Press ▲ ▼ to select [Age] or [Name] and then press ►

2 Press ▲ ▼ to select [SET] and then press [MENU/SET]

3 Set the birthday and name

Age: Press ▲ ▼ ◀ ▶ to set birthday, and press [MENU/SET].

Name: (See "Entering Text": (→139))

4 Press [MENU/SET]

■Tips

- Make sure [Age] and [Name] are [ON] before taking a picture.
- Still pictures recorded during motion picture recording will not record age or name.
- Age display format depends on [Language] setting.
- Shutter speed may slow down up to 1 second.
- [Age] and [Name] print setting can be made on your computer using "PHOTOfunSTUDIO" on the supplied CD-ROM. Text may also be stamped onto the still picture using [Text Stamp].

[Pet]

Records pet's age and name when taking pictures.

- Refer to [Baby] for other tips etc.

[Sunset]

Takes clear pictures of scenes such as sunsets.

Taking pictures according to the scene [Scene Mode]

- How to select a scene (→124)

[High Sens.]

Prevents blurring of subject in dark, indoor conditions.

1 Press ▲ ▼ to select the aspect ratio and the picture size and press [MENU/SET]

■ Settings: 4:3 3 M / 3:2 2.5 M / 16:9 2 M / 1:1 2.5 M

[Starry Sky]

Records starry skies and dark subjects.

1 Press ▲ ▼ to select shutter speed, and then press [MENU/SET]

■ Settings: [15 sec.] / [30 sec.] / [60 sec.]

■ Tips

- Tripod, self-timer recommended.
- Do not move the camera until the countdown is finished. After taking the picture, the countdown is displayed again while the signal is processed.

[Glass Through]

The camera prioritizes focusing on distant subjects. Most suitable for taking pictures such as a landscapes through the transparent glass of a train/vehicle or building.

- If there are stains such as dust or a reflection on the glass, the camera may focus on the glass instead of a subject.
- The color of pictures may appear unnatural due to the color of the glass. (You may be able to reproduce the appropriate color by adjusting the White Balance.) (→90)

- How to select a scene (→124)

[3D Photo Mode]

Pictures are recorded continuously while moving the camera horizontally, and two pictures selected automatically are combined to make a single 3D picture.

To view 3D pictures, a television that supports 3D is required (This unit will play back in 2D). For the procedure for playing back a 3D still picture (→187).

- 3D still pictures are recorded in MPO format (3D).
- The picture size is fixed to 2M 16:9.

1 Start the recording and then pan the camera horizontally straight from left to right

- A guide is displayed while recording.
- Move the camera approximately 10 cm (0.33 feet) within approximately 4 seconds using the guide.

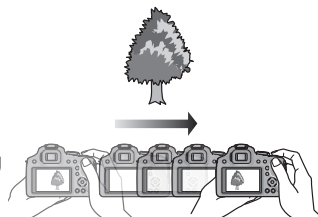

Tips for recording pictures

- Record a stationary subject.
- Record a picture outdoors or in other bright locations.
- Press the shutter button halfway to fix the focus and the exposure, press the shutter button fully, and then pan the camera.
- Hold the camera so that the subject is slightly to the right of the center on the display at the start of the recording. This makes it easier to position the subject in the center of the recorded picture.

- **3D still pictures cannot be recorded by holding this camera vertically.**
- The zoom position is fixed to the W end.
- ISO Sensitivity is automatically adjusted. However, ISO Sensitivity is increased to make the shutter speed faster.
- Motion pictures cannot be recorded.
- [Stabilizer] does not work.
- When any of the recording conditions listed below exists, it may be impossible to record any images at all. Or there may be no 3D effect, or the image may be distorted even if a picture is recorded.
 - When the subject is too dark or too bright
 - When the subject's brightness changes
 - When the subject is moving
 - When the subject lacks contrast

Recording motion pictures with manual operation [Creative Video Mode]



It is possible to manually change the aperture and shutter speed and record motion pictures. Switching the [Creative Video] setting allows you to use settings such as those when mode dial is switched to [P], [A], [S] and [M].

1 Set mode dial to [M]

2 Press ▲▼ to select the setting and press [MENU/SET]

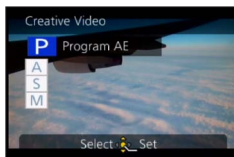

- When you select [M] by rotating the mode dial, the menu appears automatically.
- You can display the [Creative Video] menu by pressing [MENU/SET]. For the setting procedures of the menu. (→57)

3 Rotate the rear dial to set the aperture and shutter speed

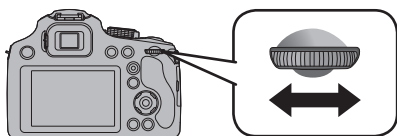

Item	Aperture values that can be set	Shutter speeds that can be set (seconds)
P	—	—
A	F2.8 - F8.0 (Wide)/ F5.9 - F8.0 (Tele)	—
S	—	1/30 to 1/20000th
M*1	F2.8 - F8.0 (Wide)/ F5.9 - F8.0 (Tele)	1/30 to 1/20000th (When using Manual Focus, the shutter speed can be set from 1/8 to 1/20000th.*2)

*1 Aperture value setting and shutter speed setting will switch every time the rear dial is pressed.

*2 If you record with the shutter speed set to slower than 1/30th of a second and [Rec Format] set to [AVCHD], the exposure time per frame will increase. Depending on the movement of the subject, this may result in blurring in the frames.

- About aperture value

To record motion pictures with a sharp focus on both subject and background, set the aperture value to a higher number. To record motion pictures with a defocused background, set a lower number.

- About the shutter speed

To record a sharp motion picture of a fast-moving subject, set a faster shutter speed. To record a motion picture with a trailing effect for a subject's movements, set a slower shutter speed.

- Press the shutter button to start and stop recording motion pictures.

- Although you can change camera settings such as shutter speed and aperture value even when a motion picture recording is in progress, the beeps and camera operation sounds may be recorded in some cases.

- When you set a faster shutter speed, the screen noise may increase due to the higher sensitivity.

- When you take a picture under a fluorescent lamp, LED, mercury arc lamp or sodium lamp, for example, the coloring and the brightness of the screen may change.

Register your own settings and record

[Custom] Mode

Registering your preferred recording mode, [Rec] menu settings, etc. to [Cust.Set Mem.] and setting the mode dial to [C] allows you to switch quickly to those settings.

[Cust.Set Mem.]

Up to 3 current camera settings can be registered.

- 1 Select the recording mode you wish to register and set the [Rec] menu, [Motion Picture] menu, [Setup] menu, etc.**
 - For the setting procedures of the menu. (→57)
- 2 Select [Cust.Set Mem.] from the [Setup] menu**
- 3 Press ▲ ▼ to select the custom set to register and then press [MENU/SET]**
 - A confirmation screen is displayed. If you select [Yes], the operation is executed.

● Some menu items are not saved, such as [Clock Set] and [Beep].

[Custom]



Settings registered in [Cust.Set Mem.] can be quickly called up by setting the mode dial to [C].

1 Set mode dial to [C] ([Custom] mode)

2 Press ▲ ▼ to select custom set and press [MENU/SET]



The camera switches to the recording mode and settings of the selected custom set.

■ When changing the menu settings

Even if the menu settings are changed temporarily when [Set1], [Set2] or [Set3] is selected for using the custom set, the currently registered settings will remain unchanged.

To change the currently registered settings, overwrite the registered data using [Cust. Set Mem.] (→134) on the [Setup] menu.

Recording with the Face Recognition function

[Face Recog.]



Default [Face Recog.] setting is [OFF].

When the face pictures are registered, the setting will be [ON] automatically.

■How the Face Recognition function works

During recording

(When [AF Mode] is [] (Face Detection))

- The camera recognizes a registered face and adjusts focus and exposure.
- When registered faces that have set names are recognized, the names are displayed (up to 3 people).



During playback

- The name and age are displayed (if information is registered).
- The names that have been set for the recognized faces are displayed (up to 3 people). ([→181](#))
- Only pictures of the selected registered people are played back ([Category Selection] in [Filtering Play] or [Slide Show]).

- When Burst is performed, recording information relating to Face Recognition is only added to the first picture.
- If you press the shutter button halfway, then point the camera at a different subject and record, recording information for a different person may be added to the picture.
- Face Recognition searches for faces similar to those registered, but there is no guarantee it will always recognize these faces. In some cases, the camera cannot recognize or incorrectly recognizes even registered people depending on their expression or the environment.
- Face Recognition may take more time to select and recognize distinctive facial features than regular face detection.
- Face recognition does not work during motion picture recording.
- Even if Face Recognition information is registered, pictures recorded when the name is [OFF] are not categorized for Face Recognition in [Category Selection].
- **Even if Face Recognition information is changed, Face Recognition information for previously recorded pictures is not changed.**
For example, if a name is changed, pictures recorded before the change are not categorized for Face Recognition in [Category Selection].
- To change name information for pictures already recorded, perform a [REPLACE] ([→181](#)) in [Face Rec Edit].
- Cannot be set in the following case.
 - [Panning] [Night Scenery] [Handheld Night Shot] [Food] [Starry Sky] [3D Photo Mode] ([Scene Mode])
 - [Miniature Effect] [Soft Focus] ([Creative Control] Mode)

Registering face pictures

Up to 6 people's face pictures can be registered along with such information as name and birthdate.

You can facilitate Face Recognition by the way you register faces: for example, register multiple face pictures of the same person (up to 3 pictures in one registration).

1 Select [Face Recog.] from the [Rec] menu (→57)

2 Press ▲ ▼ to select [MEMORY] and then press [MENU/SET]

3 Press ▲ ▼ ◀▶ to select [New] and then press [MENU/SET]
 • If 6 people are already registered, first delete a registered person. (→138)

4 Record the face picture

① Align the face with the guide and record.

② Press ▲ ▼ to select [Yes] and then press [MENU/SET].

• If re-recording, select [No]

• Faces of subjects other than people (e.g. pets) cannot be registered.

• When [DISP.] button is pressed, an explanation is displayed.



5 Press ▲ ▼ to select the item for editing and press ▶

[Name]	① Press ▲ ▼ to select [SET] and then press [MENU/SET] ② Enter the name (See "Entering Text": (→139))
[Age]	Set the birthdate. ① Press ▲ ▼ to select [SET] and then press [MENU/SET] ② Use ◀▶ to select year, month and day, set with ▲ ▼, and press [MENU/SET]
[Focus Icon]	Change the icon that is displayed when the subject is in focus. ① Select the focus icon with ▲ ▼ and then press [MENU/SET]
[Add Images]	Up to 3 face pictures of the person can be registered. ① Press ▲ ▼ to select [Add Images] and press [MENU/SET] • When a registered face picture is selected with ▲ ▼ ◀▶, a screen to confirm deletion is displayed. Select [Yes] to delete the face picture. (If only one picture is registered, it cannot be deleted.) ② Record the picture (Step 4 above) ③ Press [DISP.] (Q.MENU) button

■ Recording tips when registering face pictures

- Make sure the subject's eyes are open and mouth closed; have the subject face the camera directly, and make sure the outline of the face, the eyes and eyebrows are not hidden by hair.
- Make sure there are no heavy shadows on the face. (During registration, the flash is not used.)

■ If the camera seems to have difficulty recognizing faces when recording

- Register additional pictures of the same person's face, indoors and outdoors or with different expressions or angles.
- Register additional pictures at the place you are recording.
- If a registered person is no longer recognized, re-register that person.

Editing or deleting information about registered persons

Information about registered people can be edited or deleted.

- 1** Select [Face Recog.] from the [Rec] menu (→57)
- 2** Press ▲ ▼ to select [MEMORY] and then press [MENU/SET]
- 3** Press ▲ ▼ ◀ ▶ to select the face image to edit or delete and then press [MENU/SET]
- 4** Press ▲ ▼ to select the item and then press [MENU/SET]

[Info Edit]	Edit name or other registered information. (→137)
[Priority]	Set priority order for focus and exposure. ① Select the registration order with ▲ ▼ ◀ ▶ and then press [MENU/SET]
[Delete]	Delete information and face pictures of registered persons.

Entering Text

Use the cursor button to enter names with the Face Recognition function and in Scene Modes [Baby] and [Pet], or to register locations in [Travel Date] etc.

1 Press ▲ ▼ ◀ ▶ to select characters

2 Press [MENU/SET] several times until the desired character is displayed



Cursor position

Text is inserted at the cursor position.

- To change the character type
→ Select , and press [MENU/SET].

■ To continue entering characters

- Press ▲ ▼ ◀ ▶ to select  and then press [MENU/SET]
- Move the zoom lever toward T side
- Turn the rear dial to the right

■ Editing text

- ① Press ▲ ▼ ◀ ▶ to select  and then press [MENU/SET]. Then, move the cursor to the text to edit
 - You can also move the cursor position by rotating the zoom lever or rear dial.
- ② Press ▲ ▼ ◀ ▶ to select [Delete] and then press [MENU/SET]
- ③ Press ▲ ▼ ◀ ▶ to select the correct text, and then press [MENU/SET]

3 When you are finished entering text, press ▲ ▼ ◀ ▶ to select [Set] and press [MENU/SET]

● A maximum of 30 characters can be entered. (Maximum of 9 characters when setting names in [Face Recog.])

* A maximum of 15 characters can be entered for [\], [[], []], [•] and [—] (Maximum of 6 characters when setting names in [Face Recog.]).

Useful features for travel

[Travel Date]

If you set your travel schedule and record pictures, the day of your trip on which the picture was taken will be recorded.

- 1** Select [Travel Date] from the [Setup] menu (→57)
- 2** Press ▲ ▼ to select [Travel Setup] and then press ►
- 3** Press ▲ ▼ to select [SET] and then press [MENU/SET]
- 4** Press ▲ ▼ ◀▶ to select the departure date and press [MENU/SET]
- 5** Press ▲ ▼ ◀▶ to select the return date and press [MENU/SET]

■To record [Location]

Once the [Travel Setup] is set, you can set the location.

- ①Select [Location] in step **2** above and press ►
- ②Press ▲ ▼ to select [SET] and then press [MENU/SET]
- ③Enter your location (Entering text (→139))

- The travel date is calculated from the set departure date and the date set in the camera's clock. When destination is set in [World Time], days elapsed are calculated based on local destination time.
- When [Travel Setup] is set to [OFF], the number of days elapsed is not recorded. It is not displayed even if [Travel Setup] is set to [SET] after recording.
- If settings are made before departure date, number of days to departure are not recorded.
- To print [Location] or the number of days that have passed, either use [Text Stamp] or print using the "PHOTOfunSTUDIO" software on the supplied CD-ROM.
- [Travel Date] cannot be recorded for AVCHD motion pictures.
- [Location] cannot be recorded when taking motion pictures.
- Cannot be set when using [Intelligent Auto] Mode. The settings in other Recording Mode are applied.

[World Time]

Set the recording date and time with the local time at your destination.

1 Select [World Time] from the [Setup] menu (→57)

2 Press ▲ ▼ to select [Home] or [Destination] and then press [MENU/SET]

- Set [Home] first thing after purchasing. [Destination] can be set after setting up [Home].

3 Press ◀ ▶ to select area and press [MENU/SET]

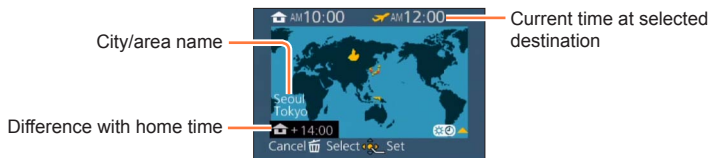

When [Destination] has been selected

■ To set daylight savings

Press ▲ in step **3**. (Press again to release the setting)

- When daylight savings is set, the current time is advanced by 1 hour. If the setting is canceled, the time automatically returns to the current time.

■ When you come back from your travel destination

Select [Home] and press [MENU/SET] twice in step **2**

- If you cannot find your destination in the area displayed on the screen, set based on difference with home time.
- [📷] is displayed on the screen for pictures recorded at the destination when they are played back.

Using the [Rec] menu

You can perform settings such as Aspect Ratio and Picture Size.

- For the setting procedures of the menu. (→57)

[Photo Style]



You can adjust the colors and picture quality according to the concept of the picture that you want to create.

■ Settings

STD. [Standard]	This is the standard setting.
VIVID [Vivid]	Brilliant effect with high saturation and contrast.
NAT [Natural]	Soft effect with low contrast.
MONO [Monochrome]	Monochrome effect with no color shades.
SCENY [Scenery]	An effect appropriate for scenes with vivid blue skies and greens.
PORT [Portrait]	An effect appropriate for portrait picture with a healthy and beautiful skin tone.
CUST [Custom]	Use the setting registered in advance.

■ Adjusting the picture quality and registering a custom setting

- ① Press ◀▶ to select the photo style to be adjusted, and press ▼
- ② Press ▲▼ to select an item and press ◀▶ to adjust
- ③ Press [MENU/SET]

Settings	Settings and results	-	+
[Contrast]	Difference between light and dark in a picture	Low	High
[Sharpness]	Picture contour	Soft	Sharp
[Saturation]*	Color change	Quiet impression	Vivid impression
NR [Noise Reduction]	Noise reduction	Priority on resolution	Priority on noise reduction
[Custom setting]	You can register the setting for the adjusted picture quality to [Custom]. ① Select [Custom setting] and press [MENU/SET] ② Select [Yes] and press [MENU/SET]		

*When [Monochrome] is selected, the color tone is changed.

- The settings of the adjusted picture quality will be stored in memory even when the camera is turned off.
- When the picture quality is adjusted, [+] will be displayed in the icon.

- For the setting procedures of the menu. (→57)

[Aspect Ratio]



Set the aspect ratio of still pictures.

- Settings: **4:3** / **3:2** / **16:9** / **1:1**

- Edges may be cut off when printing – be sure to check in advance. (→218)
- Cannot be set in the following case.
 - [3D Photo Mode] ([Scene Mode])

[Picture Size]



The higher the numbers of pixels, the finer the detail of the pictures will appear even when they are printed onto large sheets.

- Settings

[Aspect Ratio]	4:3	3:2	16:9	1:1
Picture Size	16M 4608×3456	14M 4608×3072	12M 4608×2592	12M 3456×3456
	10M * 3648×2736	9M * 3648×2432	7.5M * 3648×2056	7.5M * 2736×2736
	7M * 3072×2304	6M * 3072×2048	5.5M * 3072×1728	5.5M * 2304×2304
	5M * 2560×1920	4.5M * 2560×1712	3.5M * 2560×1440	3.5M * 1920×1920
	3M * 2048×1536	2.5M * 2048×1360	2M * 1920×1080	2.5M * 1536×1536
	0.3M * 640×480	0.3M * 640×424	0.2M * 640×360	0.2M * 480×480

*This setting is not available in [IA] ([Intelligent Auto] Mode).

Setting guide

Larger picture size	←→	Smaller picture size
Sharper		Less detailed
Lower recording capacity		Higher recording capacity

- If you change the aspect ratio, set the picture size again.
- Mosaic effect may appear depending on subject and recording conditions.
- Cannot be set in the following case.
 - [High Sens.] [3D Photo Mode] ([Scene Mode])
 - When [Quality] is set to [RAW]

- For the setting procedures of the menu. (→57)

[Quality]



Set quality of picture.

■ Settings

[Fine]	Gives priority to picture quality and saves pictures in JPEG file format.
[Standard]	Saves pictures in JPEG file format using standard picture quality.
RAW [RAW+Fine]	Saves pictures in JPEG file format in addition to the RAW file format.*1
RAW [RAW+Standard]	
RAW [RAW]	Saves pictures in the RAW file format.*2
[3D+Fine]	Simultaneously saves 3D still picture data (MPO) and pictures in JPEG file format. (Only when [3D Photo Mode] Scene Mode is set.)
[3D+Standard]	

*1 If you delete a RAW file from the camera, the corresponding JPEG file is also deleted.

*2 You cannot set the picture size. (The pictures are saved using the maximum recordable pixels for each image aspect ratio.)

■ About RAW file

You can use Ichikawa Soft Laboratory's "SILKYPIX Developer Studio" to save RAW pictures in JPEG or other file formats that can be displayed on a PC, etc., in order to perform advanced editing.

Download "SILKYPIX Developer Studio" from website and install it on your computer to use. For details on how to download the software, etc., refer to (→192).

- [Quality] is fixed to [] in [High Sens.] Scene Mode.
- You cannot set to [], [], or [RAW] in the following cases.
 - [Panorama Shot] Mode
 - [Panning] [Handheld Night Shot] [HDR] ([Scene Mode])
 - When [Burst] is set to []

- For the setting procedures of the menu. (→57)

[ISO Limit Set]



You can set the upper limit of ISO Sensitivity when [Sensitivity] is set to [AUTO] or [Auto].

■ Settings: [AUTO] / [200] / [400] / [800] / [1600] / [3200]

- This function is disabled during motion picture recording. (Except [Creative Video Mode])
- Setting items below will be selectable in Creative Video Mode.
[AUTO] / [200] / [400] / [800] / [1600] / [3200] / [6400]

[ISO Increments]



You can adjust the ISO sensitivity settings for every 1/3 EV.

■ Settings

Settings	Description of settings
[1/3EV]	[100], [125], [160], [200], [250], [320], [400], [500], [640], [800], [1000], [1250], [1600], [2000], [2500], [3200], [4000]*, [5000]*, [6400]*
[1EV]	[100], [200], [400], [800], [1600], [3200], [6400]*

*Only in [Creative Video Mode]

- When the setting is changed from [1/3EV] to [1EV], ISO sensitivity will be set to value closest to the value set during the [1/3EV]. (Set value will not restore when the setting is changed back to [1/3EV]. It will stay as the setting selected for [1EV].)

- For the setting procedures of the menu. (→57)

[Face Recog.]

For details (→136).

[AF Mode]

For details (→95).

[AF Style]



Select how the focus is adjusted when taking a still picture. You can set whether or not to lock the focus on a moving subject.

■ Settings

Settings	The movement of the subject and the scene (recommended)	Description of settings
[AFS]	Subject is still (Scenery, anniversary photograph, etc.)	"AFS" is an abbreviation of "Auto Focus Single". Focus is set automatically when the shutter button is pressed halfway. Focus will be fixed while it is pressed halfway.
[AFF]	Movement cannot be predicted (Children, pets, etc.)	"AFF" is an abbreviation of "Auto Focus Flexible". In this mode, focusing is performed automatically when the shutter button is pressed halfway. If the subject moves while the shutter button is pressed halfway, the focus is corrected to match the movement automatically.
[AFC]	Subject is moving (Sport, trains, etc.)	"AFC" is an abbreviation of "Auto Focus Continuous". In this mode, while the shutter button is pressed halfway, focusing is constantly performed to match the movement of the subject. When the subject is moving, the focusing is performed by predicting the subject position at the time of recording.

- When recording using [AFF], [AFC]
 - Press the shutter button halfway again when it is difficult to focus on the subject.
 - While the shutter button pressed halfway, shake may be seen on the screen.
 - The battery will be consumed faster than usual.

- For the setting procedures of the menu. (→57)

[Quick AF]



As long as the camera is held steady, the camera will automatically adjust the focus and focus adjustment will then be quicker when the shutter is pressed. This is useful when you do not want to miss a picture-taking opportunity.

■ Settings: [ON] / [OFF]

- The battery will be consumed faster than usual.
- Focus alignment may take time if zoom is suddenly changed from max. W to max. T, or if suddenly moving closer to subject.
- Press shutter button halfway if focus is difficult to align.
- [Quick AF] will not work while AF Tracking is operating.
- Cannot be set in the following case.
 - [Panning] [Night Portrait] [Night Scenery] [Handheld Night Shot] [Starry Sky] ([Scene Mode])
 - [Soft Focus] ([Creative Control] Mode)

[AF/AE Lock]

For details (→106).

- For the setting procedures of the menu. (→57)

[Metering Mode]



Type of optical measurement to measure brightness can be changed.

■ Settings

[Metering Mode]	Brightness measurement position	Conditions
 [Multi Metering]	Whole screen	Normal usage (produces balanced pictures)
 [Center Weighted]	Center and surrounding area	Subject in center
 [Spot]	Center and close surrounding area	Great difference between brightness of subject and background (e.g. person in spotlight on stage, backlighting)

[i.Dynamic]



This function automatically adjusts contrast and exposure to produce pictures with closer-to-actual colors when there is a significant difference between light and dark in the background and the subject.

■ Settings: [HIGH] / [STANDARD] / [LOW] / [OFF]

- If [i.Dynamic] is activated even when [Sensitivity] is set to [100], pictures may be recorded with an ISO Sensitivity higher than [100].
- Compensation effect may not be achieved depending on the conditions.
- Cannot be set in the following case.
 - When the [Quality] setting is set to [RAW:16:1], [RAW:12:1] or [RAW]

- For the setting procedures of the menu. (→57)

[Min. Shtr Speed]



Sets the minimum value for the shutter speed. We recommend using slower shutter speeds to take brighter pictures in dark locations. Also, you can set it faster to reduce the blur of the subject.

■ Settings: [AUTO] [1/250] [1/125] [1/60] [1/30] [1/15] [1/8] [1/4] [1/2] [1]

- Slower shutter speeds allow for brighter pictures but increase risk of jitter, so we recommend using a tripod and the self-timer.
- As still pictures may become dark when using faster values, we recommend that still pictures are taken in bright locations ([MIN] flashes red when shutter button is pressed halfway if still picture will be dark).
- [MIN] displayed on screen for settings other than [AUTO].

[i.Resolution]



You can use the camera's Intelligent Resolution technology to record still pictures with sharper outlines and clearer resolution.

■ Settings: [i.ZOOM] / [ON] / [OFF]

- About [i.ZOOM] (→76)

[Digital Zoom]



Zoom 5 times further than Optical/Extended optical zoom. Note that enlarging will decrease picture quality with Digital Zoom.

For details (→77).

■ Settings: [ON] / [OFF]

- For the setting procedures of the menu. (→57)

[Stabilizer]



Automatically detects and prevents jitter.

■ Settings: [ON] / [OFF]

■ Active Mode

When recording motion pictures, "Active Mode" (stabilizer for motion pictures) will automatically function. This decreases the jitter of the image when recording motion pictures while walking, etc.

- In "Active Mode", stronger effect of the correction can be achieved at the wide end.
- In the following case, "Active Mode" will not function even when recording motion pictures.
 - When [Rec Quality] is set to [VGA] in [MP4]
 - When [Conversion] is set
 - When [Stabilizer] is set to [OFF] in [Creative Video Mode]

- Cases where the stabilizer function may be ineffective:
 - When there is a lot of jitter
 - When the zoom magnification is high (also in the Digital Zoom range)
 - When taking pictures while following a moving subject
 - When the shutter speed becomes slower to take pictures indoors or in dark places
- The setting is fixed to [ON] in [Handheld Night Shot] Scene Mode.
- The setting is fixed to [OFF] in the following Scene Modes: [Starry Sky], [3D Photo Mode]
- Even if you set to [ON], only jitter in the vertical direction will be corrected in [Panning] Scene Mode.

- For the setting procedures of the menu. (→57)

[AF Assist Lamp]



Illuminates lamp when dark to facilitate focus alignment.

- The AF Assist Lamp has an effective distance of 1.5 m (4.9 feet).

■ Settings

[ON]	Lamp illuminated with halfway press of shutter button ([AF*] appears)
[OFF]	Lamp is not illuminated. (taking pictures of animals in the dark, etc.)

- Do not block the lamp with your fingers or look at it from close range.
- A vignetting effect may appear on the circumference of the AF Assist Lamp because the AF Assist Lamp may be obscured by the lens, however, this does not cause a problem with the performance of the camera.
- The setting is fixed to [OFF] in the following cases.
 - [Scenery] [Panning] [Night Scenery] [Handheld Night Shot] [Sunset] [Glass Through] ([Scene Mode])
 - When [Conversion] is set

[Flash]

For details (→79).

- For the setting procedures of the menu. (→57)

[Flash Synchro]



You can set the timing for firing the flash depending on the picture that you want to create.

■ Settings: [1ST] / [2ND]

Flash firing timing chart

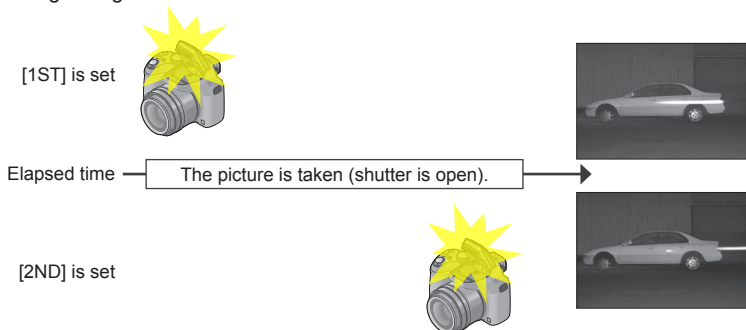

- Normally, set to [1ST].
- If you set to [2ND], [2nd] will be displayed in the flash icon on the screen.
- When a fast shutter speed is set, the Flash Synchro effect may not be sufficiently achieved.
- [Flash Synchro] can be used even when you use an external flash.

- For the setting procedures of the menu. (→57)

[Flash Adjust.]



You can adjust the intensity of the flash when you take a picture of a small subject, or when the flash reflectance is extremely high or low.

■ Settings: -2 EV to +2 EV (unit: 1/3 EV)

When you do not want to adjust the intensity of the flash, select [0 EV].

- When the intensity of the flash is adjusted, [+] or [-] is displayed on the flash icon.
- The flash intensity setting will be stored in memory even when the camera is turned off.
- [Flash Adjust.] can be used even when you use an external flash.

[Red-Eye Removal]



Automatically detects red-eye and corrects still picture data when recording with flash red-eye reduction ([A] [S]).

■ Settings: [ON] / [OFF]

- Depending on the circumstance, it may not be possible to correct red-eye.
- When this function is set to [ON], the flash icon changes to [A] [S].
- This function only works when the camera detects a subject as a face.
- It will be fixed to [ON] during the Intelligent Auto Mode.
- [Red-Eye Removal] does not function in [Scene Mode] except [Portrait], [Soft Skin], [Night Portrait] and [Baby].

- For the setting procedures of the menu. (→57)

[Color Mode]

For details (→39).

[Motion Deblur]

For details (→40).

[iHandheld Nite Shot]

For details (→40).

[iHDR]



For details (→41).

[Conversion]



With the optional conversion lenses, you can record even more faraway pictures and take close-up pictures of smaller subjects.

■ Settings

	When you attach the tele conversion lens.
	When you attach the close-up lens.
[OFF]	—

- Refer to (→202) for details about attaching the lens.
- Ensure that [Conversion] is set to [OFF] when not using a conversion lens.
- [Conversion] is set to [OFF] in [Handheld Night Shot] [3D Photo Mode] Scene Mode.
- Read the operating instructions of the conversion lens for details.

- For the setting procedures of the menu. (→57)

[Auto Bracket]



Records 3 pictures in continuous succession while exposure is changed automatically. After exposure adjustment, the adjustment value is set as the standard.

1 Press ◀▶ to set the compensation range of the exposure and then press [MENU/SET]

- When Auto Bracket is set, [Auto Bracket] is displayed on the screen.
- The first still picture is recorded without compensation, the second still picture is recorded with exposure adjusted in the “-” direction, and the third still picture is recorded with exposure adjusted in the “+” direction.
- When you do not use Auto Bracket, select “0”.



Value displayed after Exposure Compensation set

- In Shutter-Priority AE and Manual Exposure, if the shutter speed is set to more than 1 second, Auto Bracket is canceled.
- Cannot be used with flash.
- During motion picture recording, [Auto Bracket] cannot be set.
- Cannot be set in the following case.
 - [Handheld Night Shot] [HDR] [Starry Sky] [3D Photo Mode] ([Scene Mode])
 - [Miniature Effect] [Soft Focus] [Star Filter] ([Creative Control] Mode)

- For the setting procedures of the menu. (→57)

[Date Stamp]



Still pictures can be taken with the recording date and time stamped on the still picture.

■ Settings: [W/O TIME] / [WITH TIME] / [OFF]

- Do not request date printing in store or make date printing on printer for still pictures with date stamps. (Date printing may be overlapped.)
- Date stamps on still pictures cannot be erased.
- The setting is fixed to [OFF] in the following cases.
 - [3D Photo Mode] ([Scene Mode])
 - When recording motion pictures
 - When using Auto Bracket
 - When using [Burst]
- Cannot change the setting in [Intelligent Auto] Mode. The setting in other recording mode is applied.
- [Text Stamp], [Resize], [Cropping] and [Leveling] cannot be set for pictures recorded with [Date Stamp] set.
- Even if you take a picture with [Date Stamp] set to [OFF], it is possible to stamp dates onto the recorded pictures using [Text Stamp] (→171) or setup the Date print (→179, 199).

[Clock Set]



Set the clock. Same function as that in [Setup] menu. (→27)

Using the [Motion Picture] menu

You can select the recording mode and picture quality and other settings.

- In Creative Video Mode, the settable [Rec] menu will be displayed in the [Motion Picture] menu.
- The [Motion Picture] menu is not displayed in the following cases.
 - [3D Photo Mode] ([Scene Mode])
 - [Panorama Shot] Mode
 - [Soft Focus]/[Star Filter] ([Creative Control] Mode)

- For the setting procedures of the menu. ([→57](#))

[Rec Format]



Sets the data format of the motion picture that is recorded.

■ Settings

[AVCHD]	Select this format to record HD (high definition) motion pictures for playback on your HDTV using an HDMI connection.
[MP4]	This data format is suited for playing back motion pictures on a computer and other such devices.

- For details ([→46](#))

- For the setting procedures of the menu. (→57)

[Rec Quality]



Sets the picture quality of the motion picture that is recorded.

■ Settings

[AVCHD] in [Rec Format]

Item	Picture size	fps*	Bit rate
[FSH]	1920×1080	60i	Approx. 17 Mbps
[SH]	1280×720	60p	Approx. 17 Mbps

*The sensor output rate is 30 fps.

[MP4] in [Rec Format]

Item	Picture size	fps	Bit rate
[FHD]	1920×1080	30p	Approx. 20 Mbps
[HD]	1280×720	30p	Approx. 10 Mbps
[VGA]	640×480	30p	Approx. 4 Mbps

■ About motion picture icon

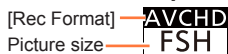

● What is bit rate

This is the volume of data for a definite period of time, and the quality becomes higher when the number gets bigger. This unit is using the “VBR” recording method. “VBR” is an abbreviation of “Variable Bit Rate”, and the bit rate (volume of data for definite period of time) is changed automatically depending on the subject to record. Therefore, the recording time is shortened when a subject with fast movement is recorded.

- For the setting procedures of the menu. (→57)

[Continuous AF]



Either allow the focus to be constantly adjusted during motion picture recording, or fix the focus position at the start of recording.

■ Settings

[ON]

[OFF]: Fix focus position at the start of motion picture recording.

- The setting is fixed to [OFF] in the following case.
 - [Starry Sky] ([Scene Mode])

[Wind Cut]



Automatically detects wind sounds (wind noise) captured by the microphones and suppresses the sound if the wind is blowing too strongly.

■ Settings

[AUTO]: Wind noise is automatically suppressed depending on volume

[OFF]

- When [Wind Cut] is set to [AUTO], the sound quality may differ from that of normal recordings.
- It is fixed to [OFF] in the following cases.
 - [Miniature Effect] ([Creative Control] Mode)
 - When the [Zoom Mic] is set to [ON]

- For the setting procedures of the menu. (→57)

[Zoom Mic]



Coupled to the zoom operation, it will clearly record far sounds with tele, and surrounding sounds with wide.

■ Settings: [ON] / [OFF]

- When set to [ON] and performing zoom, the operation sound may be recorded enhanced in accordance with the surrounding sounds. Also, audio recording level will be lower compared to when [OFF].
- The stereo effect of the audio is reduced when the picture is enlarged.
- The setting is fixed to [OFF] in the following case.
 - [Miniature Effect] ([Creative Control] Mode)

Changing the picture information display, etc.

You can disable the display of picture information (file number, etc.) and recording information (settings used for recording, etc.) when a picture is played back.

1 Press [DISP.] button to change display

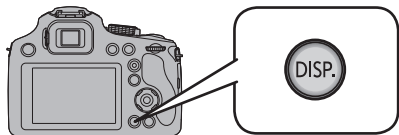

Has picture information
(recording date and time, etc.)

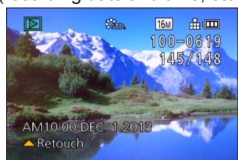

Has recording information*1
([Flash], [Sensitivity] etc.)



No display*2



*1 If the [Histogram] in [Setup] menu is set to [ON], Histogram will be displayed.

*2 Name of the registered person in [Face Recog.] is displayed when [DISP.] is pressed.

- During Playback Zoom, Motion Picture Playback, automatic scrolling playback of panorama pictures, and Slide Show:
You can only turn the display on or off.
- During Multi Playback or calendar screen: Display cannot be changed.

Different playback methods [Playback Mode]

Recorded pictures can be played back in a variety of ways.
To change the Playback Mode, refer to and perform the following steps.

1 Press [MENU/SET] in playback mode

2 Press ►

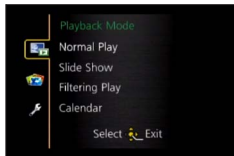

3 Press ▲ ▼ to select the Playback Mode and press [MENU/SET]

[2D/3D Settings]	Switches the output format between 2D and 3D pictures. (Only available during HDMI output.) (→187)
[Normal Play]	Plays back all pictures. (→49)
[Slide Show]	Automatically plays back recorded pictures, one after another. (→163)
[Filtering Play]	Plays back the pictures after narrowing them down according to various conditions. (→165)
[Calendar]	Displays pictures by date of recording. (→52, 166)

[2D/3D Settings]

The playback method for the 3D pictures can be switched. This menu is only displayed during HDMI output. For the procedure for playing back a 3D still picture (→187).

- For the setting procedures of the menu. (→57)

[Slide Show]

Automatically play pictures in order. Recommended when viewing on TV screen.

1 Press ▲ ▼ to select the playback method and press [MENU/SET]

[All]	Play all.
[Picture Only]	Plays back still pictures.
[Video Only]	Plays back motion pictures.
[3D Play]	Plays back 3D still pictures recorded using [3D Photo Mode] Scene Mode only.
[Category Selection]	Select category and play back motion or still pictures. (Select category with ▲ ▼ ◀ ▶ and press [MENU/SET].) (→165)
[Favorite]	Play back pictures set as [Favorite]. (→178)

2 Press ▲ ▼ to select [Start] and press [MENU/SET]

■ Operations during Slide Show

The operation guide appears on the bottom right of the LCD monitor.

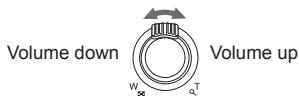
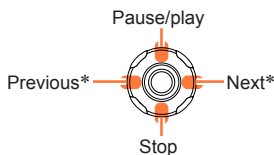

*Operable only in the following cases.

- in the Pause Mode
- during motion picture playback
- during panorama picture playback

- When [URBAN] has been selected, the picture may appear in black and white as a screen effect.
- Part of [Effect] cannot be used when displaying pictures on television using an HDMI mini cable or when displaying pictures recorded in portrait position.
- Screen effects do not operate during a [3D Play] slide show.
- Music effects cannot be added.

■ Changing the slide show settings

You can change the settings for slide show playback by selecting [Effect] or [Setup] on the slide show menu screen.

[Effect] (Select music and effects according to picture atmosphere)	
[AUTO] (only available with [Category Selection] setting) / [NATURAL] / [SLOW] / [SWING] / [URBAN] / [OFF]*1	
[Setup]	
[Duration]*2	[1 SEC.] / [2 SEC.] / [3 SEC.] / [5 SEC.]
[Repeat]	[ON] / [OFF]
[Sound]	[AUTO]: With still pictures, music will play back, and with motion pictures, audio will play back. [Music]: Music effect will play back. [Audio]: Audio is played back from motion pictures. [OFF]: Music and audio will not play back.

*1 When [Video Only] is selected in Step **1** (→163), playback effects are fixed to [OFF].

*2 This effect can be set only when [Effect] is set to [OFF]. Note, however, that the [Duration] setting will not be effective in the following cases.

- Motion pictures
- Panorama pictures

- For the setting procedures of the menu. (→57)

[Filtering Play]

You can select and display pictures that you want to play back, for example, pictures in any category or your favorite pictures.

1 Press ▲▼ to select the playback method and press [MENU/SET]

[Picture Only]	Play back still pictures.																		
[Video Only]	Play back motion pictures.																		
[3D Play]	Play back only pictures that were recorded using [3D Photo Mode] Scene Mode.																		
[Category Selection]	Press ▲▼◀▶ to select the category and then press [MENU/SET] to set <table border="1" data-bbox="291 569 966 1093"> <tr> <td>[Face Recog.]</td> <td>Select a person registered to Face Recognition and display the pictures ① Press ▲▼◀▶ to select the person to play back and then press [MENU/SET]</td> </tr> <tr> <td>[Portrait etc.]</td> <td>Only display pictures recorded with [Portrait], [Soft Skin], [Night Portrait], [Baby] from Scene Mode*</td> </tr> <tr> <td>[Scenery etc.]</td> <td>Only display pictures recorded with Panorama Mode, and [Scenery], [Sunset], [Glass Through] from Scene Mode*</td> </tr> <tr> <td>[Night Scenery etc.]</td> <td>Only display pictures recorded with [Night Portrait], [Night Scenery], [Handheld Night Shot], [Starry Sky] from Scene Mode*</td> </tr> <tr> <td>[Events]</td> <td>Only display pictures recorded with [Sports], [Panning] from Scene Mode</td> </tr> <tr> <td>[Baby]</td> <td>Only display pictures recorded with [Baby] from Scene Mode*</td> </tr> <tr> <td>[Pet]</td> <td>Only display pictures recorded with [Pet] from Scene Mode</td> </tr> <tr> <td>[Food]</td> <td>Only display pictures recorded with [Food] from Scene Mode</td> </tr> <tr> <td>[Travel Date]</td> <td>Only display pictures recorded when [Travel Date] is set</td> </tr> </table> <p>* Even if the scene is auto-detected with [Intelligent Auto] Mode, it will be categorized in the same way.</p>	[Face Recog.]	Select a person registered to Face Recognition and display the pictures ① Press ▲▼◀▶ to select the person to play back and then press [MENU/SET]	[Portrait etc.]	Only display pictures recorded with [Portrait], [Soft Skin], [Night Portrait], [Baby] from Scene Mode*	[Scenery etc.]	Only display pictures recorded with Panorama Mode, and [Scenery], [Sunset], [Glass Through] from Scene Mode*	[Night Scenery etc.]	Only display pictures recorded with [Night Portrait], [Night Scenery], [Handheld Night Shot], [Starry Sky] from Scene Mode*	[Events]	Only display pictures recorded with [Sports], [Panning] from Scene Mode	[Baby]	Only display pictures recorded with [Baby] from Scene Mode*	[Pet]	Only display pictures recorded with [Pet] from Scene Mode	[Food]	Only display pictures recorded with [Food] from Scene Mode	[Travel Date]	Only display pictures recorded when [Travel Date] is set
[Face Recog.]	Select a person registered to Face Recognition and display the pictures ① Press ▲▼◀▶ to select the person to play back and then press [MENU/SET]																		
[Portrait etc.]	Only display pictures recorded with [Portrait], [Soft Skin], [Night Portrait], [Baby] from Scene Mode*																		
[Scenery etc.]	Only display pictures recorded with Panorama Mode, and [Scenery], [Sunset], [Glass Through] from Scene Mode*																		
[Night Scenery etc.]	Only display pictures recorded with [Night Portrait], [Night Scenery], [Handheld Night Shot], [Starry Sky] from Scene Mode*																		
[Events]	Only display pictures recorded with [Sports], [Panning] from Scene Mode																		
[Baby]	Only display pictures recorded with [Baby] from Scene Mode*																		
[Pet]	Only display pictures recorded with [Pet] from Scene Mode																		
[Food]	Only display pictures recorded with [Food] from Scene Mode																		
[Travel Date]	Only display pictures recorded when [Travel Date] is set																		
[Favorite]	Play back pictures set as [Favorite].																		

- When the camera is turned off or when the camera is switched to a recording mode, normal playback is resumed.

- For the setting procedures of the menu. ([→57](#))

[Calendar]

Select the date from the calendar screen to view only the pictures taken on that day. ([→52](#))

Retouching pictures

[Auto Retouch]

You can adjust the color and brightness of a still picture to bring them into balance.

- New pictures are created after editing pictures with [Auto Retouch]. Before starting to edit, make sure that there is enough free space in the built-in memory or memory card.



• Example picture

1 Select a still picture to retouch during playback and press **▲**

2 Press **▲ ▼** to select [Auto Retouch] and press [MENU/SET]

3 Press **▲ ▼** to select [ON] and press [MENU/SET]

- A confirmation screen is displayed. If you select [Yes], the new retouched still picture is saved.
- When [OFF] is selected, you can restore a picture to its original condition (before retouching).

■ Operation from the [Playback] menu

- ① Select [Retouch] in the [Playback] menu, and then press **▶**
 - ② Press **▲ ▼** to select [Auto Retouch] and press [MENU/SET]
 - ③ Press **◀ ▶** to select picture and press [MENU/SET]
- Read Step **3** above to perform further steps.

- The retouch effect may be less apparent in some still pictures.
- Some still pictures may have higher noise levels after retouching.
- It may not be possible to use [Auto Retouch] with still pictures that have already been retouched.
- [Auto Retouch] is unable to perform in the following cases:
 - Motion pictures
 - Panorama pictures
 - 3D still pictures
 - Still pictures recorded with the [Quality] setting [RAW:iii], [RAW:ii] or [RAW]

[Creative Retouch]

You can retouch recorded still pictures by selecting the effect that you want to apply.

- New pictures are created after editing pictures with [Creative Retouch]. Before starting to edit, make sure that there is enough free space in the built-in memory or memory card.

1 Select a still picture to retouch during playback and press **▲**

2 Press **▲ ▼** to select [Creative Retouch] and press [MENU/SET]

3 Press **▲ ▼** to select effect

- The picture retouched with the selected effect is displayed.
- When [No Effect] is selected, you can restore a picture to its original condition (before retouching).

Setting	Effect
[Expressive]	This picture effect creates a pop art style picture that enhances the color.
[Retro]	This picture effect creates the soft appearance of a tarnished picture.
[Old Days]	This effect adds a bright, soft and nostalgic feel to the overall image.
[High Key]	This picture effect creates a brighter and lighter toned appearance for the entire picture.
[Low Key]	This picture effect creates a darker somber appearance for the entire picture to emphasize the bright portions.
[Sepia]	This picture effect creates a picture with sepia tone.
[Dynamic Monochrome]	This picture effect creates a monochromatic picture with a higher contrast and more dramatic atmosphere.
[Impressive Art]	A picture effect with strong contrast that illustrates a surreal and dramatic atmosphere.
[High Dynamic]	This picture effect creates a picture with a well-balanced brightness for the entire picture (from dark areas to bright areas).
[Cross Process]	This picture effect creates a unique atmosphere with surprising colors.
[Toy Effect]	This picture effect creates a picture that resembles pictures taken by a toy camera with a reduced amount of peripheral light.

(Continued on the next page)

Setting	Effect
[Miniature Effect]	This effect blurs peripheral areas to give the impression of a diorama.
[Soft Focus]	This picture effect creates a soft appearance by intentionally blurring the entire picture.
[Star Filter]	This picture effect creates a picture with the light from the light source that shines in the shape of a cross, creating a gorgeous atmosphere.
[One Point Color]	This picture effect creates a monochromatic picture by retaining the color you selected only, and adds memorable emphasis to it.

- For more information about picture effects (→114 - 120)

4 Press [MENU/SET]

- A confirmation screen is displayed. If you select [Yes], the new retouched still picture is saved.
- Set the effect in the following cases.

[Cross Process]	Press ◀▶ to adjust coloring, then press [MENU/SET].
[Toy Effect]	
[Miniature Effect]	① Press ▲▼ or ◀▶ to move the focusing area (frame) ② Rotate the rear dial to select the size of the focusing area (frame) ③ Press [MENU/SET]
[One Point Color]	Select the color to be retained with ▲▼◀▶ and press [MENU/SET].

■ Operation from the [Playback] menu

- ① Select [Retouch] in the [Playback] menu, and then press ▶
 - ② Press ▲▼ to select [Creative Retouch] and press [MENU/SET]
 - ③ Press ◀▶ to select picture and press [MENU/SET]
- Read Step 3 (→168) to perform further steps.

- The retouch effect may be less apparent in some still pictures.
- The image effect may appear weak compared to the effect given by the [Creative Control] Mode.
- [Creative Retouch] is unable to be performed in the following cases:
 - Motion pictures
 - Panorama pictures
 - 3D still pictures
 - Still pictures recorded with the [Quality] setting [RAW:📷], [RAW:📷] or [RAW]

Using the [Playback] menu

You can specify picture protection, resizing, print settings, and other settings for pictures you have taken.

- For the setting procedures of the menu. (→57)
- The setting methods vary depending on the menu item.

● In the following cases, new pictures are created after they have been edited. Before starting to edit, make sure that there is enough free space in the built-in memory or memory card.

- [Text Stamp]
- [Leveling]
- [Retouch]
- [Cropping]

[Title Edit]

You can give titles, etc. to your favorite still pictures.

1 Press ▲ ▼ to select [Single] or [Multi] and then press [MENU/SET]

2 Select a still picture

● [Single]

Press ◀ ▶ to select a still picture and press [MENU/SET]



● [Multi] (up to 50 pictures with the same text)

Press ▲ ▼ ◀ ▶ to select a still picture and press [DISP.] button

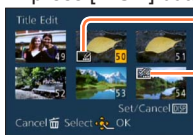

[Title Edit] setting

[Title Edit] already set

- To cancel
→ Press [DISP.] button again.
- To execute
→ Press [MENU/SET].

3 Enter characters (Entering text (→139))

- To delete a title, delete all the characters in the character input screen.

● Cannot be used in the following cases:

- Motion pictures
- 3D still pictures
- Still pictures recorded with the [Quality] setting [RAW], [RAW] or [RAW]
- To print text, use [Text Stamp] or "PHOTOfunSTUDIO" on the supplied CD-ROM.

- For the setting procedures of the menu. (→57)

[Text Stamp]

You can stamp the recording date/time, name, location, Travel Date or title onto the recorded pictures.

1 Press ▲▼ to select [Single] or [Multi] and then press [MENU/SET]

2 Select a still picture

- [Single]

Press ◀▶ to select a still picture and press [MENU/SET]

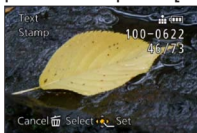

- [Multi] (up to 50 pictures)

Press ▲▼◀▶ to select a still picture and press [DISP.] button

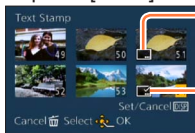

[Text Stamp] setting

[Text Stamp] already set

- To cancel
→ Press [DISP.] button again.
- To execute
→ Press [MENU/SET].



3 Press ▲▼ to select items and press ▶ (→172)

4 Press ▲▼ to select the setting and press [MENU/SET] (→172)



5 Press [MENU/SET]

- Confirmation screen is displayed. If you select [Yes], the operation is executed.

■ Items that can be stamped

[Shooting Date]	[W/O TIME]: Stamp recording date [WITH TIME]: Stamp recording date and time
[Name]	 : Stamp name registered in Face Recognition  : Stamp name registered in [Baby] or [Pet]
[Location]	Stamp location registered in [Setup] menu's [Travel Date]
[Travel Date]	Stamp Travel Date set in [Setup] menu's [Travel Date]
[Title]	Stamp text registered in [Title Edit]

- Items set to [OFF] are not stamped.

- **Do not request date printing in store or make date printing on printer for still pictures with date stamps. (Date printing may be overlapping.)**
- Cannot stamp texts on the following pictures.
 - Motion pictures
 - 3D still pictures
 - Panorama pictures
 - Still pictures that date or other texts had already been stamped
 - Still pictures taken without setting clock
 - Still pictures recorded with the [Quality] setting [RAW , [RAW ] or [RAW]
- Characters may be cut off on certain printers.
- Text is difficult to read when stamped on pictures of 0.3M or less.

[Retouch]

- [Auto Retouch]: For details ([→167](#))
- [Creative Retouch]: For details ([→168](#))

- For the setting procedures of the menu. (→57)

[Video Divide]

A single motion picture can be split into 2 parts. This is convenient when you want to keep just the necessary scenes, or if you wish to delete unnecessary scenes to increase free space on your card, such as when traveling.

1 Press ◀▶ to select the motion picture to divide, and then press [MENU/SET]

2 Press ▲ at where you want to split a motion picture to pause it

- You can finely adjust the location for division by pressing ◀▶ while the motion picture is paused.

3 Press ▼



- A confirmation screen is displayed. It is executed when [Yes] is selected.
- **The original motion picture that was split does not remain.**
(There will only be the 2 motion pictures that were created after the split.)

- During splitting, do not turn off the camera or remove the card or battery. If you do so, the motion picture may be deleted.
- Splitting a motion picture recorded in [MP4] changes the order of pictures. It is recommended to display with [Video Only] in [Filtering Play] or [Calendar].
- Motion pictures cannot be divided at a location close to the start or end of the motion picture.
- Motion pictures with a short recording time cannot be divided.

- For the setting procedures of the menu. (→57)

[Resize]

Picture size can be reduced to facilitate e-mail attachment and use in web pages, etc. (Still pictures recorded at the smallest recording pixel level cannot be further reduced.)

■[Single]

- 1** Press ▲ ▼ to select [Single] and press [MENU/SET]
- 2** Press ◀ ▶ to select the picture, and then press [MENU/SET]
- 3** Press ◀ ▶ to select the size, and then press [MENU/SET]

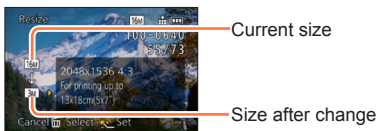

- Confirmation screen is displayed. If you select [Yes], the operation is executed.

(Continued on the next page)

■ [Multi]

- 1 Press ▲ ▼ to select [Multi] and press [MENU/SET]
- 2 Press ▲ ▼ to select the size, and then press [MENU/SET]
- 3 Press ▲ ▼ ◀ ▶ to select a still picture and press [DISP.] button
(up to 50 pictures)

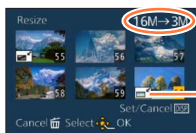

Number of pixels before/after resizing

Resize setting

- To cancel
→ Press [DISP.] button again.
- To execute
→ Press [MENU/SET].

• Confirmation screen is displayed. If you select [Yes], the operation is executed.

- Picture quality is reduced after resizing.
- Cannot resize the following pictures.
 - Motion pictures
 - 3D still pictures
 - Panorama pictures
 - Still pictures that date or other texts had already been stamped
 - Still pictures recorded with the [Quality] setting [RAW₁], [RAW₂] or [RAW]

- For the setting procedures of the menu. (→57)

[Cropping]

Enlarge your still pictures and crop unwanted areas.

1 Press ◀▶ to select the picture, and then press [MENU/SET]

2 Select area to crop and press [MENU/SET]



Change position

- Confirmation screen is displayed. If you select [Yes], the operation is executed.

- Original Face Recognition information will not be copied when still pictures are cropped.
- Picture quality is reduced after cropping.
- Cannot crop the following pictures.
 - Motion pictures
 - 3D still pictures
 - Panorama pictures
 - Still pictures that date or other texts had already been stamped
 - Still pictures recorded with the [Quality] setting [RAW:iii], [RAW:ii] or [RAW]

- For the setting procedures of the menu. (→57)

[Leveling]

Slight slanting in the still picture can be corrected.

- 1** Press ◀▶ to select the picture, and then press [MENU/SET]
- 2** Press ◀▶ to adjust the skewed angle of view and then press [MENU/SET]



- Confirmation screen is displayed. If you select [Yes], the operation is executed.

- The personal information related to Face Recognition recorded in an original still picture will not be copied to the pictures after their skewed angle of view is corrected.
- Picture quality is reduced when leveling is performed.
- A skewed angle of view for the following pictures cannot be corrected.
 - Motion pictures
 - 3D still pictures
 - Panorama pictures
 - Still pictures that date or other texts had already been stamped
 - Still pictures recorded with the [Quality] setting [RAW_{Hi}], [RAW_{Lo}] or [RAW]

- For the setting procedures of the menu. (→57)

[Favorite]

By labeling your favorite pictures with a star (★), you can play back your favorite pictures only, or you can delete all pictures except your favorites. Up to 999 pictures can be set as favorites.

1 Press ▲▼ to select [Single] or [Multi] and then press [MENU/SET]

2 Press ▲▼◀▶ to select picture and press [MENU/SET]

● [Single]

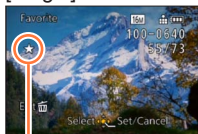

Favorite picture setting

● [Multi]

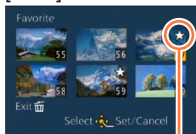

Favorite picture setting

- To cancel → Press [MENU/SET] again.

■ To clear all

Select [Cancel] in step **1** and select [Yes].

- You cannot select the [Favorite] setting for still pictures recorded with the [Quality] setting [RAW].

- For the setting procedures of the menu. (→57)

[Print Set]

Picture/picture no./date printing settings can be made for when printing with DPOF print-compatible shops or printers. (Ask at the shop to check for compatibility.)

When you want to use a photo printing store to print pictures recorded on the built-in memory, copy them to a card (→182) and then set the print setting.

For more information visit:

http://panasonic.jp/dc/dpof_110/white_e.htm

- 1** Press ▲ ▼ to select [Single] or [Multi] and then press [MENU/SET]
- 2** Press ▲ ▼ ◀ ▶ to select picture and press [MENU/SET]
- 3** Press ▲ ▼ to set the number of prints, and then press [MENU/SET] to set

(repeat steps 2 and 3 when using [Multi] (up to 999 pictures))

● [Single]



Date print set

No. to print

● [Multi]



Date print set

No. to print

- Date print setting/release → Press [DISP.] button

■ To clear all

Select [Cancel] in step 1 and select [Yes].

- Date print setting cannot be made for still pictures that have been taken with [Date Stamp] and pictures with a [Text Stamp] applied.
- Depending on the type of printer, the printer settings may take priority over camera settings.
- Cannot be set for files that are not compliant with the DCF standard.
- Some DPOF information set by other equipment cannot be used. In such cases, delete all of the DPOF information and then set it again with this camera.
- Print setting cannot be made for motion pictures.
- You cannot select the [Print Set] setting for still pictures recorded with the [Quality] setting [RAW].

- For the setting procedures of the menu. (→57)

[Protect]

You can set protection for pictures you do not want to be deleted by mistake.

1 Press ▲▼ to select [Single] or [Multi] and then press [MENU/SET]

2 Press ▲▼◀▶ to select picture and press [MENU/SET]

● [Single]



Picture protected

● [Multi]

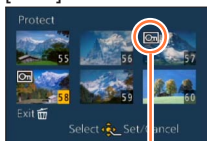

Picture protected

- To cancel → Press [MENU/SET] again.

■ To clear all

Select [Cancel] in step **1** and select [Yes].

- The picture is erased when formatting, even if it is protected.
- May not be effective when using other devices.
- When you set the write-protect switch on the card to the "LOCK" position, the picture is not erased.

- For the setting procedures of the menu. (→57)

[Face Rec Edit]

Edit or delete the recognition information for pictures with mistaken Face Recognition.

- 1 Press ▲▼ to select [REPLACE] or [DELETE] and then press [MENU/SET]**
- 2 Press ◀▶ to select the picture and then press [MENU/SET]**
- 3 Press ◀▶ to select the person and then press [MENU/SET]**
 - People whose Face Recognition information has not been registered cannot be selected.
- 4 (When [REPLACE] is selected) Press ▲▼◀▶ to select the person to replace and then press [MENU/SET]**
 - Confirmation screen is displayed. If you select [Yes], the operation is executed.

- When Face Recognition information is deleted, it cannot be restored.
- Pictures for which all Face Recognition information has been deleted are not categorized in Face Recognition during [Category Selection].
- Recognition information cannot be edited in protected pictures.

- For the setting procedures of the menu. (→57)

[Copy]

You can copy pictures between built-in memory and memory card.

1 Press ▲▼ to select the copy destination and then press [MENU/SET]



Copy all pictures from built-in memory to card.



Copy 1 picture at a time from card to built-in memory.

2 (When [SD→IN] is selected) Press ◀▶ to select the picture and then press [MENU/SET]

- Confirmation screen is displayed. If you select [Yes], the operation is executed.

- Copying pictures may take several minutes. Do not turn off the camera or perform other operations during copying.
- If identical names (folder/file numbers) are present in the copy destination, a new folder for copying will be created when copying from built-in memory to card (IN→SD). Identically-named files will not be copied from card to built-in memory (SD→IN).
- The following settings are not copied. Set them again after copying.
 - [Print Set] - [Protect] - [Favorite]
- Only pictures from Panasonic digital cameras (LUMIX) may be copied.
- Motion pictures recorded in [AVCHD] format cannot be copied.

Viewing on TV screen

You can view pictures on a TV screen by connecting your camera to your TV with the HDMI mini cable or AV cable (optional).

- Also consult TV operating manual.

Preparation:

- Set [TV Aspect] to connect your camera to a TV using the AV cable (optional) (→71).
- Turn off both camera and TV.

1 Connect camera to TV (→184)

2 Turn on TV

- Set to auxiliary input.

3 Turn on the camera and press the Playback button

- Input of the TV will switch automatically and playback screen is displayed when connected to a VIERA Link compatible TV using an HDMI mini cable with the [VIERA Link] (→71) set to [ON]. (→185)

- Depending on the [Aspect Ratio], black bands may be displayed on the top and bottom or the left and right of the pictures.
- Change the screen mode on your TV if the picture is displayed with the top or bottom cut off.
- Output from the HDMI mini cable has priority when both AV cable and HDMI mini cable are connected.
- The connection with the USB connection cable will take priority when you connect the USB connection cable simultaneously with the HDMI mini cable.
- When you play back a picture vertically, it may be blurry.
- When pictures are displayed, they may not be displayed properly depending on the type of TV.
- No sound is output from the camera speakers.

The recorded pictures can be played back on a TV with an SD Memory Card slot.

- Proper playback (aspect ratio) will be dependent on the TV used for viewing.
- The file format of the motion pictures that can be played back differs depending on the TV model.
- You may not be able to play back panorama pictures. Also you cannot perform automatic scrolling playback of panorama pictures.
- For cards compatible with playback, refer to the operating instructions of the TV.

■ To connect with an HDMI mini cable

An HDMI mini cable can be used to enable viewing of still and motion pictures in high resolution.

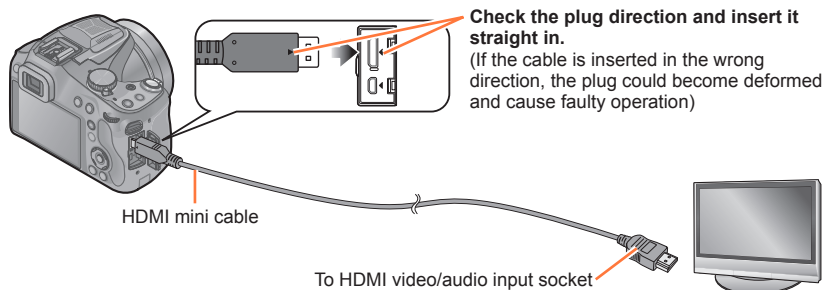

- Use a "High Speed HDMI mini cable" with the HDMI logo. Cables that do not comply with the HDMI standards will not work. "High Speed HDMI mini cable" (Type C-Type A plug, up to 3 m (9.8 feet) long)
- Audio will be played back as stereo (2ch).
- No picture is displayed on the camera screen.
- For more details about VIERA Link (HDMI) playback, refer to (→185).

■ To connect with an AV cable (optional)

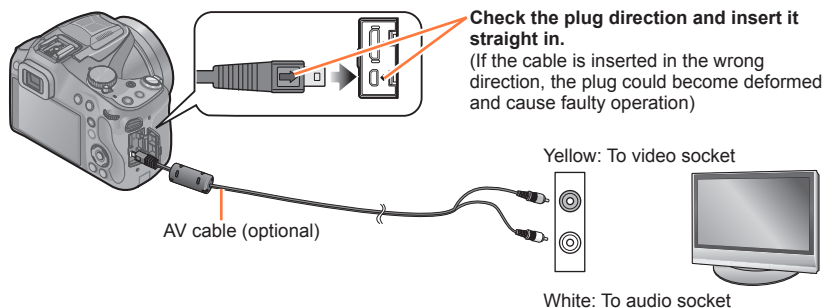

- Always use a genuine Panasonic AV cable (DMW-AVC1: optional).
- Check the [TV Aspect]. (→71)
- Audio will be played back in monaural.

VIERA Link (HDMI) (HDAVI Control™)

What is VIERA Link (HDMI)?

- VIERA Link is a function that automatically links this camera to VIERA Link-compatible devices by connecting HDMI mini cables for enabling easy operation with the VIERA remote control. (Some operations are not available.)
- VIERA Link (HDMI) is an exclusive Panasonic function added to the industry-standard HDMI control functions known as HDMI CEC (Consumer Electronics Control). Operation is not guaranteed when connecting with non-Panasonic HDMI CEC-compatible devices. Refer to your product manual to verify compatibility with VIERA Link (HDMI).
- This camera supports VIERA Link (HDMI) Version 5. This is the Panasonic standard that also supports previous Panasonic VIERA Link devices.

Preparation: Set [VIERA Link] to [ON] (→71).

1 **Connect the camera to a VIERA Link (HDMI)-compatible Panasonic television (VIERA) with an HDMI mini cable (→184)**

2 **Turn on the camera and press the Playback button**

3 **Operate with the remote control for the TV**
• Operate with reference to the operation icons displayed on the screen.

- Use a “High Speed HDMI mini cable” with the HDMI logo. Cables that do not comply with the HDMI standards will not work. “High Speed HDMI mini cable” (Type C-Type A plug, up to 3 m (9.8 feet) long)
- If you do not know if your TV is VIERA Link (HDMI) compatible, see the TV’s operating instructions.
- Cables that do not comply with HDMI standards will not work.
- To play back the audio of the motion pictures, set the [Sound] in the Slide Show setting screen to [AUTO] or [Audio].
- It is recommended to connect this unit to an HDMI terminal other than the HDMI1 if there are 2 or more HDMI input terminals on the TV.
- Operation using the button on this unit will be limited.

■ Other related operations

● Turning the unit OFF

The camera can also be turned off when the television is turned off with the remote control.

● Automatic input select

- Television input automatically switches to the camera screen if you press the Playback button while the camera is connected via the HDMI mini cable and turned on. The television can also be switched on via the camera from Standby Mode (if "Power on link" on the television is set to "on").
- Depending on the HDMI terminal on the TV, the input channel may not switch automatically. In this case, use the remote control for the TV to switch the input channel. (For details on how to switch input, please read the operating instructions for the TV.)
- If VIERA Link (HDMI) does not function correctly ([→218](#))

Viewing 3D still pictures

If you connect this camera to a 3D-capable TV, and play back still pictures that you recorded in 3D, you can enjoy impressive 3D still pictures on the TV. If a 3D-capable TV has an SD card slot, you can play back 3D still pictures that you recorded by inserting the card into the slot.

Preparation: Set [3D Playback] to [3D] (→71).

1 Connect the camera to a 3D-capable TV by use of an HDMI mini cable to display the playback screen (→184)**2** Display still pictures recorded in 3D

- When the [VIERA Link] setting on the camera is set to [ON] and the camera is connected to a VIERA Link (HDMI)-compatible Panasonic television (VIERA), the television automatically switches its input and the playback screen is displayed.
- [3D] appears on the thumbnail of the 3D still pictures.

■ To perform Slide Show playback of only still pictures recorded in 3D

Select [3D Play] in [Slide Show] of the [Playback Mode] menu (→163)

■ To select and play back only still pictures recorded in 3D

Select [3D Play] in [Filtering Play] of the [Playback Mode] menu (→165)

■ To switch the playback method for the still pictures recorded in 3D

① Select the picture recorded in 3D

② Select [2D/3D Settings] on the [Playback Mode] menu and then press [MENU/SET] (→162)

- Playback method will switch to 3D if it is playing back in 2D (conventional image), or it will switch to 2D if it is playing back in 3D.
- If you feel tired, uncomfortable or otherwise strange when playing back pictures recorded in 3D, set to 2D.

- Viewing 3D still pictures too close to a TV may cause eyestrain.
- When an image is not suitable for 3D viewing (due to excessive parallax, etc.)
 - During Slide Show playback: The image is displayed in 2D.
 - During [Filtering Play]: A message appears confirming whether to display the image in 3D or not.
- When a 3D image is played back on a TV that is not 3D-capable, 2 pictures may appear side-by-side on the screen.
- On the LCD monitor of this camera, 3D still pictures will be played back in 2D (conventional pictures).
- If you switch between 3D still pictures and normal still pictures while playing back pictures, a black screen will be displayed for a few seconds.
- If you select a thumbnail of 3D still pictures or display a thumbnail after playing back 3D still pictures, it may take a few seconds to start playing back or displaying the pictures.
- When a TV has not been converted for viewing 3D still pictures, do necessary preparation on the TV. (For details about the necessary preparation of the TV, read the manual for the TV.)
- During 3D playback, [Setup] menu, [Playback] menu, Playback Zoom, and delete operation cannot be used.
- You can store 3D still pictures on a computer or Panasonic recorder. (→189, 196)

Keeping the still pictures and motion pictures on your PC

Still/motion pictures can be copied from the camera to your computer by connecting the two together.

- Some computers can read directly from the camera's memory card.
For details, see the manual for your computer.
- If your computer does not support SDXC Memory Cards a message will be displayed requesting you to format the card. (Do not format the card. This will erase recorded pictures.) If the card is not recognized, refer to the following support website.
<http://panasonic.net/avc/sdcard/information/SDXC.html>

■ Computer specifications

You can connect the camera to a computer that can detect a mass storage device (device that stores a large volume of data).

- Windows: Windows 8 / Windows 7 / Windows Vista / Windows XP
- Mac: OS X (10.1 - 10.8)

Some motion pictures recorded in [AVCHD] may not be scanned correctly by copying a file or folder.

- When using Windows, be sure to use the "PHOTOfunSTUDIO" software on the supplied CD-ROM to copy motion pictures recorded in [AVCHD].
- When using Mac, you can copy motion pictures recorded in [AVCHD] using "iMovie '11". (For details about iMovie '11, please contact Apple Inc.)

About supplied software

The supplied CD-ROM contains the following software.
Install the software on your computer before using.

■ PHOTOfunSTUDIO 9.2 AE

You can capture still pictures or motion pictures to your PC, or organize captured pictures by categorizing by recording date, model name of the digital camera used to record, etc. You can also correct still pictures, edit motion pictures, or write to DVD.

• Operating environment

Supported OS	Windows® 8 (32-bit/64-bit) Windows® 7 (32-bit/64-bit) and SP1 Windows Vista® (32-bit) SP2 Windows® XP (32-bit) SP3	
CPU	Windows® 8	Pentium® III 1 GHz or higher
	Windows® 7	
	Windows Vista®	Pentium® III 800 MHz or higher
	Windows® XP	Pentium® III 500 MHz or higher
Display	1024×768 pixels or more (1920×1080 pixels or more recommended)	
RAM	Windows® 8	1 GB or more (32-bit) / 2 GB or more (64-bit)
	Windows® 7	
	Windows Vista®	512 MB or more
	Windows® XP	
Free hard disk space	450 MB or more for installing software	

Refer to the Operating Instructions of "PHOTOfunSTUDIO" (PDF) for further information about the operating environment.

Keeping the still pictures and motion pictures on your PC

■ **LoiLoScope 30 day full trial version (Windows 8 / 7 / Vista / XP)**

LoiLoScope is a video editing software that draws out the full power of your PC. Creating videos is as easy as organizing cards on top of a desk. Use your music, picture and video files to create videos to share with your friends and family by burning it to a DVD, uploading it to websites, or simply share your videos with your friends via e-mail.

- This will only install a shortcut to the trial version download site.

For more information on how to use LoiLoScope, read the LoiLoScope manual available for download at the link below.

Manual URL: <http://loilo.tv/product/20>

Installing supplied software

The software compatible with your PC will be installed.

Preparation:

- Check your PC's specifications and operating environment for each software.
- Before inserting the CD-ROM (supplied), close all running applications.

1 Insert the CD-ROM with the supplied software

- The installation menu runs.

2 Click [Applications]

3 Click [Recommended Installation]

- Continue the installation procedure following the instructions displayed on the screen.

● PHOTOfunSTUDIO / LoiLoScope are not compatible with Mac.

Keeping the still pictures and motion pictures on your PC

Downloading SILKYPIX Developer Studio

This software develops and edits RAW file pictures. Edited pictures can be saved in a file format such as JPEG or TIFF that can be displayed on a PC, etc.

■ Download procedure

Download SILKYPIX Developer Studio from the following site and install it on your computer to use. (This software is not provided on the supplied CD-ROM.)

<http://www.isl.co.jp/SILKYPIX/english/p/>

• Operating environment

Supported OS	Windows® 8 Windows® 7 Windows Vista® Windows® XP Mac® OS X (10.4 - 10.8)
---------------------	--

- For details on how to use the SILKYPIX Developer Studio, refer to the “Help” or the Ichikawa Soft Laboratory’s support website.

- To download the software, the unit must be connected to the Internet.
- It may take time to download the software in some communication environments.

Copying still pictures and motion pictures

Preparation:

- When importing pictures from the built-in memory, remove any memory cards.
- Install "PHOTOfunSTUDIO" on your computer before starting the copying procedure. (→191)
- Turn on the camera and computer.

Check the plug direction and insert it straight in.
(If the cable is inserted in the wrong direction, the plug could become deformed and cause faulty operation)

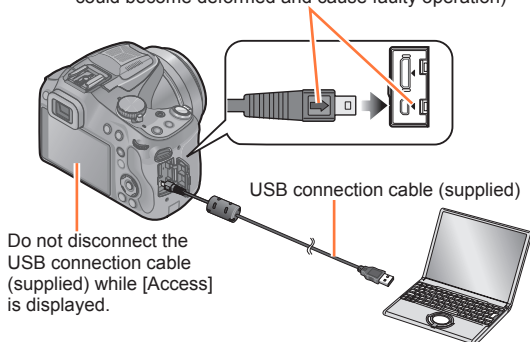
**1 Connect camera to computer**

- Do not use any other USB connection cables except the supplied one or a genuine Panasonic USB connection cable (DMW-USBC1: optional). Using cables other than the above may cause a malfunction.

2 Press ▲▼ on the camera to select [PC], and press [MENU/SET]**3 Use "PHOTOfunSTUDIO" to copy pictures to your computer**

- For details on how to use "PHOTOfunSTUDIO", see the "PHOTOfunSTUDIO" manual (PDF).

- Files and folders containing copied AVCHD motion pictures cannot be played back or edited if they have been deleted, modified, or moved using Windows Explorer or similar methods. Always use "PHOTOfunSTUDIO" when handling AVCHD motion pictures.

To cancel connection

- Windows: Execute "Safely Remove Hardware" on the taskbar
- Mac: Open the Finder and click the eject icon that appears on the sidebar

■ Copying to your computer without using “PHOTOfunSTUDIO” (except AVCHD motion pictures)

You can save pictures to use on your computer by dragging and dropping folders and files into separate folders on your computer.

Directory structure of built-in memory/card of this unit

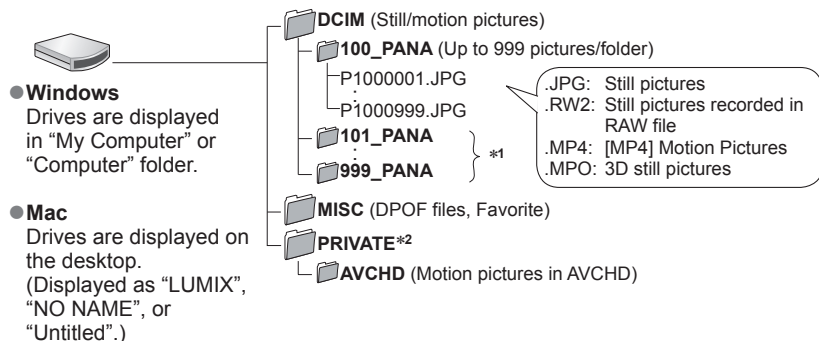

*1 New folders are created in the following cases:

- When there is a picture with file number 999 inside the folder
- When using cards already containing the same folder number (for example, pictures taken with other cameras, etc.).
- When recording after performing [No.Reset].

*2 This folder is not created in the built-in memory.

- Before inserting or removing a card, turn the camera off and disconnect the USB connection cable. Otherwise, data may be destroyed.
- Use a battery with sufficient battery power or the AC adaptor (optional).
- When the battery begins to run out during communication, a warning beep sounds. Cancel communication via your computer immediately. (→193) Otherwise, data may be destroyed.
- Before connecting or disconnecting the AC adaptor (optional), turn the camera off.
- Setting the [USB Mode] to [PC] removes the need to make the setting each time the camera is connected to the computer.
- For more details, consult your computer operating manual.

■ For PTP mode

The camera can be connected to your computer even if [USB Mode] (→70) is set to [PictBridge(PTP)].

- Only picture output can be performed.
- If you cannot connect to your PC in PTP mode, set [USB Mode] to [PC] and reconnect.
- It may not be possible to import if there are 1000 or more pictures on the card.
- Motion pictures, 3D still pictures or RAW pictures cannot be read.

Keeping the still pictures and motion pictures in the recorder

Follow the correct method for your device.

Copy by inserting the SD card into the recorder

You can copy pictures using Panasonic equipment (such as Blu-ray disc recorders) with support for each file format.

- See the instruction manual for the recorder for details for copying and playing back.



Dubbing playback pictures via AV cables (optional)

You can dub the content played back using this unit to non-compatible equipment such as recorders and video players by connecting this unit to the non-compatible equipment using an AV cable (optional). Non-compatible equipment will be able to play back the content. This is convenient if you wish to pass around dubbed content. In this case, the content will be played back in standard rather than high-definition picture quality.

1 Connect camera to recorder

2 Start playback on camera

3 Start recording on recorder

- To stop recording (dubbing), stop the recording on your recorder first before stopping the playback on the camera.

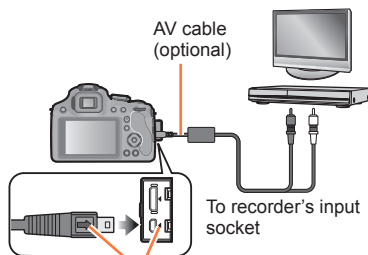

Check the plug direction and insert it straight in.
(If the cable is inserted in the wrong direction, the plug could become deformed and cause faulty operation)

- Always use a genuine Panasonic AV cable (optional).
- When using a TV with a 4:3 aspect ratio, always change the camera's [TV Aspect] setting (→71) to [4:3] before dubbing. Motion pictures copied in the [16:9] setting will appear vertically stretched when viewed on a 4:3 TV screen.
- For details on dubbing and playback methods, refer to your recorder's operating instructions.

Printing

You can connect directly to a PictBridge-compatible printer for printing.

- Some printers can print directly from the camera's memory card.
For details, see the manual for your printer.

Preparation:

- When printing pictures from the built-in memory, remove any memory cards.
- Adjust the print quality or other settings on your printer, as needed.
- Turn on the camera and printer.

Check the plug direction and insert it straight in.
(If the cable is inserted in the wrong direction, the plug could become deformed and cause faulty operation)

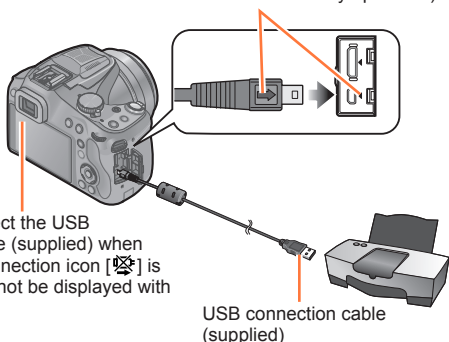

- Do not disconnect the USB connection cable (supplied) when the cable disconnection icon [⊗] is displayed (may not be displayed with some printers).

USB connection cable (supplied)

1 Connect camera to printer

- Do not use any other USB connection cables except the supplied one or a genuine Panasonic USB connection cable (DMW-USBC1: optional). Using cables other than the above may cause a malfunction.

2 Press ▲ ▼ on the camera to select [PictBridge(PTP)], and press [MENU/SET]

- Disconnect USB connection cable (supplied) after printing.
- Use a battery with sufficient battery power or the AC adaptor (optional). When the battery begins to run out during communication, a warning beep sounds. Cancel printing and disconnect USB connection cable (supplied).
- Before connecting or disconnecting the AC adaptor (optional), turn the camera off.
- Before inserting or removing a card, turn the camera off and disconnect the USB connection cable.
- Still pictures recorded in a RAW file cannot be printed. (The still pictures recorded in JPEG file format at the same time as the RAW file can be printed.)
- Motion pictures cannot be printed.

Selecting a single picture and printing it

- 1** Press ◀▶ to select the picture and then press [MENU/SET]
- 2** Press ▲ to select [Print start] and then press [MENU/SET]
(Print settings (→199))

Selecting multiple pictures and printing them

- 1** Press ▲ to select [Multi Print]
- 2** Press ▲ ▼ to select an item and then press [MENU/SET]

Item	Description of settings
[Multi Select]	① Scroll between pictures with ▲ ▼ ◀ ▶, select pictures to print with the [DISP.] button. (Press [DISP.] button again to release selection.) ② Press [MENU/SET] when selection is complete.
[Select All]	Print all pictures.
[Print Set (DPOF)]	Print pictures selected in [Print Set]. (→179)
[Favorite]	Print pictures selected as [Favorite]. (→178)

- 3** Press ▲ to select [Print start] and then press [MENU/SET]
(Print settings (→199))
 - Select [Yes] if print confirmation screen is displayed.

- An orange “●” displayed during printing indicates an error message.
- Print may be divided into several pictures if printing a large amount of pictures.
(Remaining sheets display may differ from the number of pictures set for printing.)

Print Settings

Setting options include the number of printed pictures and their size. Make settings before selecting [Print start].

1 Press ▲ ▼ to select the item and press ►

2 Press ▲ ▼ to select setting and press [MENU/SET]

- To print to paper sizes/layouts not supported by this camera, set to [] and make settings on the printer. (Consult your printer's operating manual.)
- Items may not be displayed if incompatible with printer.
- When [Print Set (DPOF)] has been selected, the [Print with Date] and [Num.of prints] items are not displayed.

■ [Print with Date]

[ON]	Date is printed.
[OFF]	Date is not printed.

- If the printer does not support date printing, the date cannot be printed on the picture.
- When setting [Print with Date] to [ON], check the date printing settings on the printer (printer settings may be prioritized).
- To print a picture on which text or a date has been stamped, set [Print with Date] to [OFF]. (The still picture is printed with the date superimposed on it.)

■ [Num.of prints]



You can set the number of prints up to 999.



■ [Paper Size]



	Settings on the printer are prioritized.
[L/3.5"×5"]	89 mm×127 mm
[2L/5"×7"]	127 mm×178 mm
[POSTCARD]	100 mm×148 mm
[16:9]	101.6 mm×180.6 mm
[A4]	210 mm×297 mm

[A3]	297 mm×420 mm
[10×15cm]	100 mm×150 mm
[4"×6"]	101.6 mm×152.4 mm
[8"×10"]	203.2 mm×254 mm
[LETTER]	216 mm×279.4 mm
[CARD SIZE]	54 mm×85.6 mm

■ [Page Layout] (Layouts for printing that can be set with this unit)

	Settings on the printer are prioritized.
	1 picture with no frame on 1 page
	1 picture with a frame on 1 page

	2 pictures on 1 page
	4 pictures on 1 page

- To arrange  "2 pictures" or  "4 pictures" in the same still picture, set the number of prints for the still picture to 2 or 4.

Print with date and text

■ Printing date without [Text Stamp]

- Printing in store: Only recording date can be printed. Request date printing in store.
 - Making [Print Set] (→179) settings on the camera in advance allows settings for numbers of copies and date printing to be designated before giving the card to the store.
 - When printing still pictures of 16:9 Aspect Ratio, check in advance that the store can accept this size.
 - You cannot request a store to print the characters entered for [Age] or [Name] of [Baby] and [Pet] in [Scene Mode] or [Face Recog.], [Travel Date], [Location], and [Title Edit].
 - Using computer: Print settings for recording date and text information can be made using "PHOTOfunSTUDIO" software on the supplied CD-ROM.
 - Using printer: Recording date can be printed by setting [Print Set] on the camera, or by setting [Print with Date] (→199) to [ON] when connecting to a printer compatible with date printing.
-
- Time and date can be set to be printed on the picture when taking the picture by activating the [Date Stamp] function in the [Rec] menu. (→156)

Optional accessories

Conversion Lens (optional)

With the optional conversion lenses, you can record even more faraway pictures and take close-up pictures of smaller subjects.

Preparations: Remove the lens cap.

1 Attach the lens adaptor

- Rotate the lens adaptor slowly and carefully.

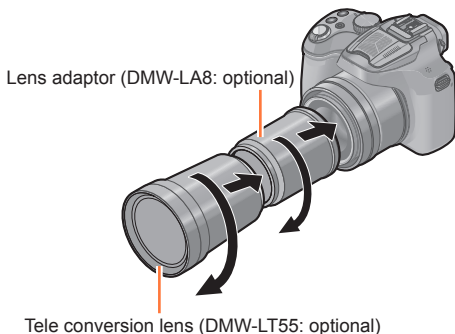

2 Attach the tele conversion lens

- Close-up lens (DMW-LC55: optional) can be attached in a similar manner.

		Tele conversion lens	Close-up lens
Zoom magnification (Max. number of pixels)		35x to 60x*	7x to 60x
Recordable range	Wide	5.5 m (18 feet) to ∞	18 cm (0.59 feet) to 50 cm (1.6 feet)
	Tele		37 cm (1.2 feet) to 50 cm (1.6 feet)

* The actual magnification when the zoom is used will be 1.7 times the display.

3 Select [Conversion] on the [Rec] menu (→57)

- Refer to (→154) for [Conversion].

4 Press ▲ ▼ to select [D₁], and press [MENU/SET] to set

- Set in same way to select [D₂] too.
- Always set to [OFF] when the conversion lens is taken off.

- **Lens adaptor (optional) is needed to use the conversion lens.**
- MC protector (optional) or ND filters (optional) cannot be used together with the conversion lens. Remove them before attaching the conversion lens.
- **Do not use with anything other than DMW-LC55 or DMW-LT55.**
- When there is dirt (water, oil, and fingerprints, etc.) on the surface of the lens, the image may be affected. Lightly wipe the surface of the lens with a soft, dry cloth before and after taking pictures.
- When using the tele conversion lens:
 - We recommend using a tripod.
 - The Stabilizer function may not work sufficiently.
 - The focus indication may light due to the jitter even if the subject is not focused.
 - The time required for focusing may become longer than usual.

Protector/Filter (optional)

The MC protector (DMW-LMCH55: optional) is a transparent filter which affects neither the colors nor the amount of light, so it can always be used to protect the camera's lens. The ND filter (DMW-LNDH55: optional) reduces the amount of light to approximately 1/8th (equal to adjusting the aperture value 3 increments) without affecting the color balance. PL filter (DMW-LPL55: optional) will suppress the reflected light from a metal or non spherical surfaces (flat non-metallic surfaces, water vapor or invisible particles in the air), making it possible to take a picture with enhanced contrast.

- Do not attach multiple filters at the same time.
- If the filter is tightened too much, you may not be able to remove it. Do not tighten it too much.
- If the filter is dropped, it may be destroyed. Be careful not to drop it when attaching it to the camera.
- Be careful not to get a fingerprint, dirt, etc., on the filter when it is attached, otherwise the focus may be adjusted to the lens, resulting in the subject being out of focus.
- Refer to the operating instructions for each filter for details.

External Flash (optional)

After attaching the external flash (DMW-FL220, DMW-FL360, DMW-FL360L, DMW-FL500: optional), the effective range will be increased when compared to the camera's built in flash.

Preparations: Turn off the camera and close the built-in flash.

1 Attach the dedicated flash to the hot shoe and then turn on the camera and the dedicated flash





- Be sure to firmly secure to the dedicated flash with the lock ring.

2 Select [Flash] on the [Rec] menu (→57)

3 Press ▲ ▼ to select the mode and then press [MENU/SET]

4 Press [MENU/SET] to close the menu

- While the external flash is connected, the following icons are displayed.

	AUTO
	AUTO/Red-Eye Reduction
	Forced flash on
	Slow sync./Red-Eye Reduction
	Forced flash off

■When using other commercially available external flashes without communication functions with the camera

- It is necessary to set the exposure on the external flash. If you want to use the external flash in Auto Mode, use an external flash that allows you to set the aperture value and the ISO sensitivity to match the settings on the camera.
- Set to Aperture-Priority AE Mode or Manual Exposure Mode on the camera and then set the same aperture value and ISO sensitivity on the external flash. (The exposure cannot be compensated adequately due to the change on the aperture value in Shutter-Priority AE Mode and the external flash cannot control the light adequately in Program AE Mode because the aperture value cannot be fixed.)

- You can set the aperture value, the shutter speed and the ISO sensitivity on the camera even when attaching the external flash.
- Some commercial external flashes have synchro terminals with high-voltage or reversed polarity. Using such extra flashes may cause a malfunction or the camera may not operate normally.
- If you use commercially available external flashes with communication functions other than the dedicated one, they may not operate normally or they may be damaged. Do not use them.
- Even if the external flash is turned off, the camera may enter the External Flash Mode when the external flash is attached. When you are not using the external flash, detach it.
- When attaching the external flash, the built-in flash cannot be activated.
- Do not open the built-in flash when an external flash is attached.
- The camera will become unstable when attaching the external flash, it is recommended to use a tripod when taking picture.
- Turn off the camera when removing the external flash.
- Detach the external flash when carrying the camera.
- When attaching the external flash, do not hold only the external flash because it may detach from the camera.
- If you use the external flash when the White Balance is set to [☐] finely adjust the White Balance depending on the picture quality. (→92)
- If you take pictures close to the subject in Wide, the vignetting effect may appear on the bottom of the recorded picture.
- This unit does not support wireless mode and is not capable of recording using the DMW-FL360L wireless external flash.
- Read the operating instructions of the external flash for details.

AC adaptor (optional)/DC coupler (optional)

The AC adaptor (optional) can only be used with the designated Panasonic DC coupler (optional). The AC adaptor (optional) cannot be used by itself.

Preparations: Turn this unit off and confirm that the lens barrel is retracted.

- 1** Pull open the card/battery door and the DC coupler cover
- 2** Insert the DC coupler into this unit
 - Insert by pushing the center of the DC coupler.
 - Press on the DC coupler until it is locked by lever.
- 3** Pull out the cable through the opening as shown in the illustration and then close the card/battery door
 - Be careful not to catch the cable when closing the card/battery door.
- 4** Plug the AC adaptor into an electrical outlet
- 5** Connect the AC adaptor to the [DC IN] socket of the DC coupler

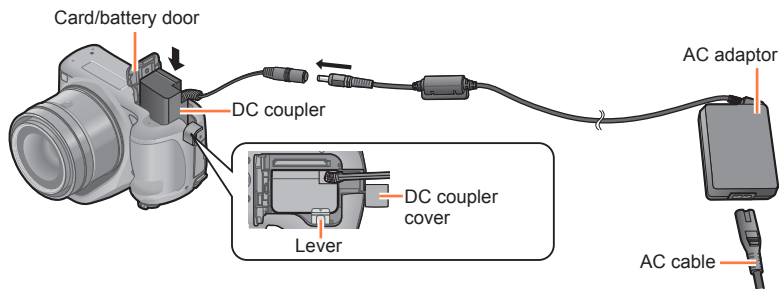

- Always use a genuine Panasonic AC adaptor (optional).
- When using an AC adaptor, use the AC cable supplied with the AC adaptor.
- If the AC adaptor and DC coupler are not necessary, then remove them from the digital camera. Also, please keep the DC coupler cover closed.
- Also read the operating instructions for the AC adaptor and DC coupler.

List of LCD monitor/Viewfinder displays

Screens shown here are only examples. The actual display may vary.

In recording

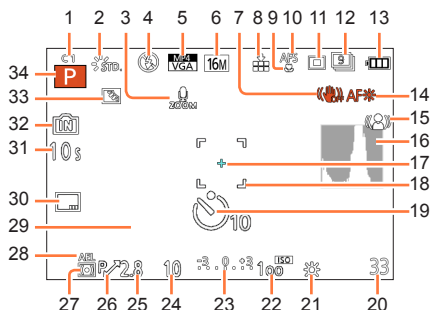

- 1 Custom Settings (→134)
- 2 Photo style (→142)
Color Mode (→39)
☞ : Creative control adjustment display (→113)
- 3 Zoom Microphone (→160)
- 4 Flash Mode (→79)
Flash output adjustment (→153)
- 5 Recording format (→157)
Recording quality (→158)
- 6 Picture Size (→143)
- 7 Stabilizer Off (→150)
((Ⓜ)) : Jitter alert (→28)
- 8 Quality (→144)
- 9 AF Macro Mode (→100)
🔍 : Macro Zoom Mode (→102)
- 10 AF Style (→146)
MF : MF (→103)
AFL: AF lock (→105)
- 11 AF Mode (→95)
- 12 Burst (→83)
📷 : Auto Bracket (→155)
- 13 Battery Indication (→18)
- 14 AF Assist Lamp (→151)
Focus (→35)
- 15 Motion Deblur (→40)
- 16 Histogram (→65)
- 17 Spot Metering Target (→148)
- 18 AF area (→35)
- 19 Self-timer Mode (→86)
- 20 Number of Recordable Pictures (→24)
Available recording time (→45): RXXmXXs*
- 21 White Balance (→90)
White Balance Fine Adjustment (→92, 93)
BKT : White Balance Bracket (→93)
- 22 ISO Sensitivity (→88)
ISO Limit Set (→145)
- 23 Exposure compensation value (→82)
Manual Exposure Assistance (→111)
Zoom (→75):
EZ W [] T 1 X
- 24 Shutter speed (→32, 109, 110)
MIN : Minimum Shutter Speed (→149)
- 25 Aperture value (→32, 108, 110)
- 26 Program Shift (→33)
- 27 Metering Mode (→148)
- 28 AE lock (→105)
- 29 Current date and time/
🌐 : World Time (→141)
Number of days that have passed since the departure date (→140)
Location (→140)
Name (→129, 137)
Age (→129, 137)
Exposure meter (→33, 67)
- 30 Date Stamp (→156)
- 31 Elapsed Recording Time (→45):
XXhXXmXXs*
- 32 Built-in Memory (→23)
📄 : Card (→23)
(displayed only during recording)
- 33 Backlight Compensation (→37, 41)
- 34 Recording Mode (→29)

* "h" is an abbreviation for hour, "m" for minute and "s" for second.

Screens shown here are only examples. The actual display may vary.

In playback

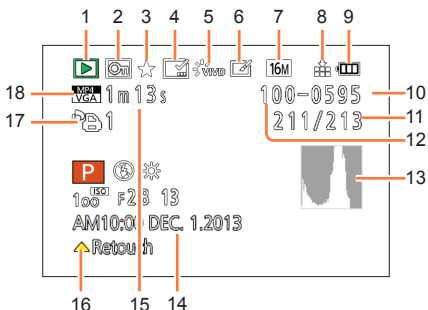

- 16 Auto Retouch (→167)
- Creative Retouch (→168)
- Motion picture playback (→53)
- Play panorama (→123)
- 17 Number of Prints (→179)
- 18 Recording format (→157)
- Recording quality (→158)
- ☒ : Cable disconnection warning icon (→197)

* "h" is an abbreviation for hour, "m" for minute and "s" for second.

- 1 Playback Mode (→162)
- 2 Protected picture (→180)
- 3 Favorites (→178)
- 4 Date/Text stamped display (→156, 171)
- 5 Photo style (→142)
- Color Mode (→39)
- 6 After Auto Retouch (→167)
- After Creative Retouch (→168)
- 7 Picture Size (→143)
- 8 Quality (→144)
- 9 Battery Indication (→18)
- 10 : Built-in Memory (→23)
- Elapsed playback time (→53): XXhXXmXXs*
- 11 Picture Number/Total Pictures
- 12 Folder/File Number (→49, 194)
- 13 Histogram (→65)
- 14 Location (→140)
- Recording information (→161)
- Name (→129, 137)
- Age (→129, 137)
- Title (→170)
- Number of days that have passed since the departure date (→140)
- Recorded date and time
- : World Time (→141)
- 15 Motion picture recording time (→53): XXhXXmXXs*

Message displays

The following explains the meaning of major messages displayed on the LCD monitor or viewfinder, and how to respond to them.

[Some pictures cannot be deleted] [This picture cannot be deleted]

- Non-DCF pictures (→49) cannot be deleted.
→ Save needed data on a computer or other device, and then use [Format] on the camera. (→73)

[Cannot be set on this picture]

- [Print Set], [Title Edit], or [Text Stamp] cannot be made for non-DCF pictures (→49).

[Please turn camera off and then on again] [System Error]

- This is displayed when the lens has stopped operating normally due to being pressed on by a hand etc.
→ Turn the camera on again.
(Consult the dealer or your nearest Service Center if display still remains.)

[Some pictures cannot be copied] [Copy could not be completed]

- Pictures cannot be copied in following cases.
 - Picture of same name already exists in built-in memory when copying from card.
 - File is not of DCF standard (→49).
 - Picture taken or edited on a different device.

[Built-in memory full] [Memory card full] [Not enough space on built-in memory] [Not enough memory on the card]

- There is no space left on the built-in memory or the card. When you copy pictures from the built-in memory to the card (batch copy), the pictures are copied until the capacity of the card becomes full.

[Built-In Memory Error] [Format built-in memory?]

- Displayed when formatting built-in memory via computer, etc.
→ Reformat directly using camera. Data will be deleted. (→73)

[Memory card error. This card cannot be used in this camera. Format this card?]

- The card format cannot be used with this camera.
→ Try with a different card.
→ Save needed data on a computer or other device, and then use [Format] on the camera. (→73)

[Insert SD card again] [Try another card]

- Access to card has failed.
→ Insert card again.
- Try with a different card.

**[Memory Card Error] [Memory card parameter error]
[This memory card cannot be used]**

- Use a card compatible with this unit.
 - SD Memory Card (8 MB to 2 GB)
 - SDHC Memory Card (4 GB to 32 GB)
 - SDXC Memory Card (48 GB, 64 GB)

[Read Error] / [Write Error] [Please check the card]

- It has failed to read or write data. Remove the card after turning this unit off. Insert the card again, turn this unit on, and try to read or write the data again.
- Card may possibly be damaged.
- Try with a different card.

[Cannot record due to incompatible format(NTSC/PAL) data on this card.]

- Format the card after saving necessary data on a PC etc. (→73)
→ Insert a different card.

[Motion recording was cancelled due to the limitation of the writing speed of the card]

- Motion picture recording may be automatically terminated with certain cards.
→ If recording stops even when using a card of the recommended speed class (→23), the data writing speed has dropped. If this happens, we recommend backing up the data on the memory card and formatting it (→73).

[A folder cannot be created]

- Folder numbers in use have reached 999.
→ Save needed data on a computer or other device, and then use [Format] on the camera. (→73)
Folder number is reset to 100 when performing [No.Reset] (→69).

[Picture is displayed for 16:9 TV] [Picture is displayed for 4:3 TV]

- Select [TV Aspect] in the [Setup] menu if you want to change the TV aspect. (→71)
- USB connection cable (supplied) is only connected to camera.
→ Message disappears when cable is also connected to another device.

[This battery cannot be used]

- Use a genuine Panasonic battery. If this message is displayed even when a genuine Panasonic battery is used, contact the dealer or Panasonic.
- Battery cannot be recognized as terminal is dirty.
→ Wipe any dirt away from the battery terminal.

[Recording failed.]

- Recording may be impossible if the recording location for a 3D image is too dark/too bright, or if the subject lacks contrast.

Q&A Troubleshooting

Try checking these items (→212 - 220) first.

If the problem persists, performing [Reset] in the [Setup] menu may resolve the issue (→70). (Note that except for some items such as [Clock Set], all settings are returned to their values at the time of purchase.)

Battery, power

Camera does not work even if the camera is turned on.

Camera switches off as soon as the camera is turned on.

- Battery is not inserted correctly (→17), or needs recharging.
- If you leave the camera on, the battery will be exhausted.
→ Turn the camera off frequently by using the [Economy] etc. (→68)

This unit is turned off automatically.

- If you connect to a TV compatible with VIERA Link (HDMI) with an HDMI mini cable and turn off the TV with the remote control for the TV, this unit also turns off.
→ If you are not using VIERA Link (HDMI), set [VIERA Link] to [OFF]. (→71)

Card/battery door does not close.

- Insert the battery securely all the way in.

Recording

Cannot record pictures.

- Built-in memory/card is full.
→ Free space by deleting unwanted pictures (→55).
- You may not be able to record for a short while after turning this unit on when using a large capacity card.

Recorded pictures look white.

- Lens is dirty (fingerprints, etc.).
→ Turn the camera off, retract the lens barrel and gently wipe the lens surface with a soft dry cloth.
- Lens is foggy (→7).

Recorded pictures are too bright/too dark.

- Adjust the exposure (→82).
- [Min. Shtr Speed] is set to fast speed. Check the setting (→149).

Some pictures are taken when I press the shutter button just once.

- Camera is set to use [WB Adjust.], [Auto Bracket] or [Burst].
- Is the Self-Timer (→86) set to [10s / 3pictures]?

Focus not aligned correctly.

- Not set to mode appropriate for distance to subject. (Focus range varies according to recording mode.)
- Subject outside of focus range. (→101)
- Caused by jitter or subject movement. (→28)

Recorded pictures are blurred. The stabilizer function ineffective.

- Shutter speed is slower in dark locations and the stabilizer function is less effective.
→ Hold camera firmly with both hands, keeping arms close to body.
- When taking pictures at a slow shutter speed, use a tripod and a self-timer (→86).
- When you record pictures using the zoom, jitter often occurs. Record pictures using the following methods to reduce jitter.
→ Use a tripod and self-timer to record pictures.
→ Hold the unit in a stable position and use a viewfinder to record pictures.
→ Increase ISO Sensitivity or use [Shutter-Priority] Mode to record pictures with a faster shutter speed.

Cannot use [Auto Bracket].

- Only enough memory for 2 pictures or fewer.

Recorded pictures appear coarse, or there is interference.

- ISO Sensitivity is high, or shutter speed is low.
(Default [Sensitivity] setting is [AUTO] – interference may appear with indoor pictures.)
→ Lower Sensitivity (→88).
→ Increase the setting for [Noise Reduction] in [Photo Style] or lower the setting for each of the items other than [Noise Reduction] (→142).
→ Take pictures in brighter locations.
- Has [High Sens.] in the Scene Mode been set? If so, the resolution of the recorded picture decreases slightly because of high sensitivity processing, but this is not a malfunction.

Striping or flicker may appear under lighting such as fluorescent lighting and LED lighting fixture.

- This is characteristic of MOS sensors which serve as the camera's pickup sensors.
This is not a malfunction.



Recording (continued)

Brightness or coloring of recorded picture different from real life.

- When recording under fluorescent or LED lighting fixture etc., increasing the shutter speed may introduce slight changes to brightness and color. These are a result of the characteristics of the light source and do not indicate a malfunction.
- When recording subjects in extremely bright locations or recording under fluorescent lighting, LED lighting fixture, mercury lamp, sodium lighting etc., the colors and screen brightness may change or horizontal striping may appear on the screen.

Horizontal streaks appear on the LCD monitor during recording.

- This is characteristic of MOS sensors which serve as the camera's pickup sensors. It appears when the subject has a bright part. Some unevenness may occur in the surrounding areas, but this is not a malfunction. It is recorded in pictures or motion pictures.
- It is recommended that you take pictures while taking care not to expose the screen to sunlight or any other source of strong light.

Motion picture recording stops midway.

- Depending on the type of the card, recording may stop in the middle.
- If recording stops even when using a card of the recommended speed class (→23), the data writing speed has dropped. If this happens, we recommend backing up the data on the memory card and formatting it (→73).

Panorama picture recording stops before finishing.

- If the pan motion of the camera is too slow, the camera assumes that the operation has been aborted and stops recording.
- If the pan motion of the camera is too shaky when it is moved toward the recording direction, the camera stops recording.
→ To record panorama pictures, pan the camera in a small circular motion parallel to the recording direction at a speed of approx. 8 seconds per revolution (guideline).

Object seems to be warped.

- Object seems to be warped slightly when the object moves across the image very fast, but this is because the unit is using MOS for the image sensor. This is not a malfunction.

The subject seems to be shaking.

- The subject may seem to be shaking when you record motion pictures using high zoom magnification because the unit is using MOS for the image sensor. This is not a malfunction. We recommend using a tripod and self-timer when you record motion pictures using high zoom magnification.

Zoom does not operate properly.

- Is the [Conversion] (→154) set to [D₇] or [0_□]?

Subject cannot be locked. (AF tracking not possible)

- Set the AF area to the distinctive color of the subject if there is a part that is different from the surrounding color.

Lens

Recorded image may be warped, or nonexistent color is surrounding the subject.

- It is possible that the subject may be warped slightly, or the borders get colored, depending on the zoom magnification, due to the characteristics of the lens. Also, the peripherals of the image might look warped because the perspective is enhanced when the wide angle is used. This is not a malfunction.

LCD monitor/Viewfinder

Pictures do not show on the LCD monitor.

- The camera is set for viewfinder display.
→ Press [LVF] button and switch to LCD monitor display.

Brightness is unstable.

- Aperture value is set while shutter button is pressed halfway. (Does not affect recorded picture.) This symptom may also occur when the brightness changes because the zoom is operated or the camera is moved. This is the automatic aperture operation of the camera and is not a malfunction.

Monitor flickers indoors.

- The LCD monitor may flicker for a few seconds after turning on. This is an operation to correct flicker caused by lighting such as fluorescent lights, LED lights etc. and is not a malfunction.

Monitor is too bright/too dark.

- [Monitor Luminance] is activated. (→63)
- Use [Monitor Display] / [Viewfinder] to adjust the brightness of the LCD monitor. (→63)

Black, red, blue and green dots appear on the LCD monitor.

- This is not a fault, and will not be recorded on the actual pictures.

Noise appears on the LCD monitor.

- In dark places, noise may appear to maintain the brightness of the LCD monitor. This does not affect the pictures you are recording.

Cannot switch between the LCD monitor and viewfinder when pressing [LVF] button.

- When it is connected to a computer or printer, the camera can display pictures on the LCD monitor only.

Flash

No flash emitted.

- Is the flash closed? (→78)
- The flash becomes unavailable in the following cases:
 - [Auto Bracket]
 - [Burst] (Excluding [Flash Burst])
 - Scene Modes ([Scenery], [Night Scenery], [Handheld Night Shot], [HDR], [Sunset], [Starry Sky], [Glass Through], [3D Photo Mode])
 - [Creative Control] Mode
 - [Panorama Shot] Mode

Multiple flashes are emitted.

- Red-eye reduction is active (→79). (Flashes twice to prevent eyes appearing red.)
- [Burst] is set to [Flash Burst].

Playback

Pictures have been rotated.

- [Rotate Disp.] (→72) is set to [Portrait] or [Landscape].

Cannot view pictures. There are no recorded pictures.

- No pictures in built-in memory or card (pictures played from card if inserted, from built-in memory if not).
- Is this a folder or picture which was processed in the PC? If so, it cannot be played back on the camera.
- During [Filtering Play], only pictures under the set filters are displayed.
 - Cancel filtering (→165).

Folder/file number displayed as [-]. Picture is black.

- Is this a non-standard picture, a picture which has been edited using a PC or a picture which was taken by another device?
- Battery removed immediately after picture taken, or picture taken with low battery.
 - Save needed data on a computer or other device, and then use [Format] on the camera. (→73)

Picture display takes a lot of time during Multi Playback.

- When you have many pictures that were edited with [Resize], [Retouch], etc., it may take several minutes for all pictures to be displayed during Multi Playback.

Incorrect date displayed in Calendar Search.

- Picture edited on computer or taken on different device.
- [Clock Set] is incorrect (→27).
 - (Incorrect date may be displayed in Calendar Search on pictures copied to a computer and then back to this unit, if computer and camera dates differ.)

White round spots like soap bubbles appear on the recorded picture.

- If you take a picture with the flash in a dark place or indoors, white round spots may appear on the picture caused by the flash reflecting particles of dust in the air. This is not a fault. A characteristic of this is that the number of round spots and their position differ in every picture.



Playback (continued)

[Thumbnail is displayed] is shown on the screen.

- The pictures may have been recorded on another device. If so, they may be displayed with poor picture quality.

Blacken red areas of recorded pictures.

- When digital red-eye correction ([A], [S]) is operating, if a subject is recorded that has skin-colored areas with red areas inside, the digital red-eye correction function may blacken the red areas.
→ We recommend setting the flash to [A], [S] or [S], or [Red-Eye Removal] to [OFF] before recording.

A clicking sound is recorded in the motion pictures.

- Camera operation sounds may be recorded as camera automatically adjusts lens aperture during motion picture recording; this is not a fault.

Motion pictures taken by this camera cannot be played in other cameras.

- Even if a device is compatible with AVCHD and MP4, the motion pictures that were recorded on this unit may have bad picture quality or sound quality upon playback, or may be unable to be played back. Also, there might be a case that a recording information does not display correctly.

TV, computer, printer

No image appears on TV. Image blurred or not colored.

- Not connected correctly (→183).
- The television has not been switched to auxiliary input.

TV screen display different to LCD monitor.

- Aspect ratio may be incorrect or edges may be cut off with certain televisions.

Cannot play motion pictures on TV.

- Card is inserted into TV.
→ Connect with AV cable (optional) or HDMI mini cable and play on camera (→183).

Picture is not displayed on full TV screen.

- Check [TV Aspect] settings (→71).

No sound is output from the camera speaker.

- When the AV cable (optional) or HDMI mini cable is connected to the camera, no sound is output from the camera.

TV, computer, printer (continued)**VIERA Link (HDMI) is not working.**

- Is the HDMI mini cable connected correctly? (→184)
 - Check that the HDMI mini cable is fully inserted.
 - Press the Playback button of the camera.
- Is the camera's [VIERA Link] setting set to [ON]? (→71)
 - The input setting may not be able to be changed automatically with certain television HDMI sockets. In this case, please change the input setting with your television's remote control (consult your television's operating instructions for details).
 - Check the VIERA Link (HDMI) settings on the device you are connecting to.
 - Turn the camera off and on again.
 - Turn the "VIERA Link control (HDMI device control)" setting on your television (VIERA) to off and then to on again. (Consult your VIERA's operating instructions for details.)

Cannot communicate with the computer.

- Not connected correctly (→193).
- Check whether computer has recognized camera.
 - Set [USB Mode] to [PC] (→70).
 - Turn the unit off and then back on again.

Computer does not recognize card (only reads built-in memory).

- Disconnect USB connection cable (supplied) and reconnect with card in place.
- If there are two or more USB terminal on a single PC, try connecting the USB connection cable to another USB terminal.

Computer does not recognize card. (When using an SDXC Memory Cards)

- Check whether your computer is compatible with SDXC Memory Cards.
<http://panasonic.net/avc/sdcard/information/SDXC.html>
- A message prompting you to format the card may appear when you connect it. Do not format the card.
- If the [Access] displayed on the LCD monitor does not disappear, disconnect the USB connection cable after turning this unit off.

Cannot print when connecting to printer.

- Printer not compatible with PictBridge.
- Set [USB Mode] to [PictBridge(PTP)] (→70).

The edges of pictures are cut off when printing.

- Release any trimming or edgeless printing settings on printer before printing. (Consult printer operating manual.)
- The pictures were recorded in [16:9] aspect ratio.
 - If printing in shop, check if 16:9 sizes can be printed.

Cannot print panorama pictures properly.

- The aspect ratio of panorama pictures is different from that of regular still pictures, and some panorama pictures may not be printed correctly.
 - Use a printer with support for panorama pictures. (Refer to the instruction manual for the printer.)
 - We recommend adjusting the size of a picture in accordance with print paper using the "PHOTOfunSTUDIO" software on the CD-ROM (supplied).

Others**Menu not displayed in desired language.**

- Change [Language] setting ([→73](#)).

Camera rattles if shaken.

- In the following cases, there is no problem with the camera, so do not worry.
 - There is a rattling sound when the camera is shaken while this unit is turned off or during playback mode. (Sound of lens moving)
 - This unit makes a rattling sound etc., when this unit is turned on or off, or when switching from recording mode to playback mode. (Sound of the aperture)
 - Vibration is felt when zooming. (Movement of the lens barrel motor)
 - When you hear a clicking or snapping sound from the lens while taking pictures. (The sound of the aperture adjusting to changes in light levels)
When this occurs, the image on the LCD monitor may appear to change dramatically. However, the picture is not affected.

Red lamp illuminated when pressing shutter button halfway in dark locations.

- [AF Assist Lamp] is set to [ON] ([→151](#)).

Part of the picture is flashing in black and white.

- This is a highlight function showing the white saturated area. ([→66](#)) (Is the [Highlight] set to [ON]?)

AF Assist Lamp is not illuminated.

- [AF Assist Lamp] is set to [OFF] ([→151](#)).
- Not illuminated in bright locations.

Camera is hot.

- Camera may become a little warm during use, but this does not affect performance or quality.

Lens makes a clicking noise.

- When brightness changes, the lens may make a clicking noise and the LCD monitor or viewfinder brightness may also change, but this is due to aperture settings being made. (Does not affect recording.)

Clock is incorrect.

- Camera has been left for a long period.
 - Reset the clock ([→27](#)).

Others (continued)**Zooming stops instantaneously.**

- When using the Extended Optical Zoom, the zooming action will stop temporarily. This is not a malfunction.

Zoom does not reach the maximum ratio.

- If the zoom ratio stops at 3 x, [Macro Zoom] has been set. ([→102](#))

File numbers are not recorded in sequence.

- File numbers are reset when new folders are created ([→194](#)).

File numbers have jumped backwards.

- Battery was removed/inserted with the camera turned on.
(Numbers may jump backwards if folder/file numbers are not correctly recorded.)

Usage cautions and notes

When in use

- Camera may become warm if used for long periods of time, but this is not a fault.
- **Keep this unit as far away as possible from electromagnetic equipment (such as microwave ovens, TVs, video games etc.).**
 - If you use this unit on top of or near a TV, the pictures and/or sound on this unit may be disrupted by electromagnetic wave radiation.
 - Do not use this unit near cell phones because doing so may result in noise adversely affecting the pictures and/or sound.
 - Recorded data may be damaged, or pictures may be distorted, by strong magnetic fields created by speakers or large motors.
 - Electromagnetic wave radiation generated by microprocessors may adversely affect this unit, disturbing the pictures and/or sound.
 - If this unit is adversely affected by electromagnetic equipment and stops functioning properly, turn this unit off and remove the battery or disconnect AC adaptor (optional). Then reinsert the battery or reconnect AC adaptor and turn this unit on.

Do not use this unit near radio transmitters or high-voltage lines.

- If you record near radio transmitters or high-voltage lines, the recorded pictures and/or sound may be adversely affected.
- Do not extend the supplied cord or cable.
- Do not allow camera to come into contact with pesticides or volatile substances (can cause surface damage or coating to peel).
- Never leave the camera and the battery in a car or on a car hood in the summer. It may cause leakage of the battery electrolyte, a generation of heat, and may cause a fire and the battery to burst due to the high temperature.

Caring for your camera

Before cleaning the camera, remove the battery or the DC coupler, or disconnect the power plug from the outlet. Then wipe the camera with a dry, soft cloth.

- Use a damp cloth to remove stubborn stains, before wiping with a dry cloth.
- Do not use benzine, thinners, alcohol, or kitchen detergent, as these may damage the outer casing and finish of the camera.
- If using a chemically-treated cloth, read the supplied instructions carefully.

When not using for a while

- Always remove the battery and the card from the camera.
- If the battery is left inserted in the camera, it will discharge even if the camera is turned off. If the battery continues to be left in the camera, it will discharge excessively and may become unusable even if charged.
- Do not leave in contact with rubber or plastic bags.
- Store together with a drying agent (silica gel) if leaving in drawer, etc. Store batteries in cool (15 °C to 25 °C (59 °F to 77 °F)) places with low humidity (40%RH to 60%RH) and no major temperature changes.
- Charge battery once per year and use completely before storing again.

Memory cards/Data

- About the picture data
 - Recorded data may be damaged or lost if the camera breaks down due to inappropriate handling. Panasonic will not be liable for any damage suffered due to loss of recorded data.
 - Pictures recorded or edited using this unit may not be played back properly or the selected effect may not be reflected in these pictures when you use other devices. Similarly, pictures that were recorded using other devices may not be played back properly or may not be able to use the functions of this unit.
- To prevent damage to cards and data
 - Avoid high temperatures, direct sunlight, electromagnetic waves, and static electricity.
 - Do not bend, drop, or expose to strong impacts.
 - Do not touch terminals on reverse of card or allow them to become dirty or wet.
- When disposing of/transferring memory cards
 - If using the "format" or "delete" functions on your camera or computer, this only changes the file management information, and does not completely delete the data from within the memory card. When disposing of or transferring your memory cards, we recommend physically destroying the memory card itself, or using commercially available computer data erasing software to completely delete the data from the card. Data within memory cards should be managed responsibly.

LCD Monitor/Viewfinder

- Do not press hard on the LCD monitor. This may cause uneven display and damage the monitor.
- In cold climates or other situations when the camera becomes cold, the LCD monitor or the viewfinder may appear slightly darker than normal immediately after the camera is turned on. Normal brightness will return once the internal components have warmed up.

The LCD monitor and viewfinder are made with extremely high precision technology. However there may be some dark or bright spots (red, blue or green) on the screen. This is not a malfunction. The LCD monitor and viewfinder screens are controlled with extremely high precision (greater than 99.99%), but some pixels (under 0.01%) may be inactive. The spots will not be recorded on pictures on the built-in memory or a card.

About charging the battery

- The time required for charging varies depending on conditions of battery usage. Charging takes longer at high or low temperatures and when the battery has not been used in some time.
- Battery will be warm during charging and for some time thereafter.
- Battery will run out if not used for long periods of time, even after being charged.
- Do not leave any metal items (such as clips) near the contact areas of the power plug. Otherwise, a fire and/or electric shocks may be caused by short-circuiting or the resulting heat generated.
- Frequently charging up battery is not recommended.
(Frequently charging battery reduces maximum usage time and can cause battery to expand.)
- If available battery power is significantly reduced, battery is reaching end of lifespan. Please purchase a new battery.
- When charging:
 - Wipe dirt from the battery terminal with a dry cloth.
 - Keep at least 1 m (3.3 feet) away from AM radio (may cause radio interference).
- Do not use a damaged or dented battery (especially connectors), e.g. by dropping (can cause faults).

Charger

- Depending on the environment while charging, the charging light may flicker due to static electricity or electromagnetic radiation, etc. This has no effect on charging.
- Keep at least 1 m (3.3 feet) away from AM radio (may cause radio interference).
- The charger may generate whirring sounds when it is being used. This is not a malfunction.
- After use, be sure to disconnect the power supply device from the electrical outlet. (A very small amount of current is consumed if it is left connected.)

Lens

- Do not press the lens with excessive force.
- Do not leave the camera with the lens facing the sun as rays of light from the sun may cause it to malfunction. Also, be careful when placing the camera outside or near a window.
- Do not leave the lens exposed to direct sunlight.
- When there is dirt (water, oil, and fingerprints, etc.) on the surface of the lens, the picture may be affected. Lightly wipe the surface of the lens with a soft, dry cloth before and after taking pictures.
- Retract the lens when carrying the camera.

When using a tripod or unipod

- Do not apply excessive force or tighten screws when they are crooked. (This may damage the camera, screw hole, or label.)
- Ensure that the tripod is stable. (Refer to the tripod instructions.)
- You may not be able to remove the card or the battery when using a tripod or unipod.

About 3D viewing

- Anyone who is hypersensitive to light, suffers from heart disease or is otherwise unwell should avoid viewing 3D pictures.
 - Viewing 3D pictures may have an adverse effect to the individual.
- If you feel tired, uncomfortable or otherwise strange when viewing 3D pictures, stop viewing at once.
 - Continuing to view may cause illness.
 - After stopping viewing, please rest appropriately.
- When viewing 3D pictures, we recommend taking a break every 30 to 60 minutes.
 - Viewing for extended periods may cause eye-fatigue.
- Short-sighted or long-sighted persons, those with differences in the sight of their right and left eyes, and those with astigmatism are advised to correct their vision by wearing glasses etc. Stop viewing if you can clearly see a double image while viewing 3D pictures.
 - There are differences in the way that different people experience 3D pictures. Please correct your sight appropriately before viewing 3D pictures.
 - You can change the 3D setting of your television or 3D output setting of the unit to 2D.

Personal Information

If names or birthdays are set in [Baby] Mode or in the [Face Recog.] function, keep in mind that the camera and recorded pictures will contain personal information.

● Disclaimer

- Data containing personal information can be altered or lost due to malfunction, static electricity, accidents, breakdowns, repairs, or other operations. Panasonic will not be liable for any damage that occurs, direct or indirect, as a result of the alteration or loss of data containing personal information.
- **When ordering repairs or transferring/disposing of the camera**
 - To protect your personal information, please reset the settings. (→70)
 - If any pictures are contained in the built-in memory, copy (→182) them to a memory card if necessary, and then format (→73) the built-in memory.
 - Remove the memory card from the camera.
 - When ordering repairs, the built-in memory and other settings may be returned to the initial purchase state.
 - If the above operations cannot be performed because of a camera malfunction, consult with the dealer or nearest Service Center.
- **When transferring or disposing of your memory card, see “When disposing of/transferring memory cards” in the previous section (→222).**
- **Uploading pictures to Web services**
 - Pictures may contain personal information that can be used to identify the user, such as titles, recording dates and times, and location information. Before uploading the pictures to Web services, check the pictures carefully for information that should not be disclosed.



- SDXC Logo is a trademark of SD-3C, LLC.
- HDMI, the HDMI Logo, and High-Definition Multimedia Interface are trademarks or registered trademarks of HDMI Licensing LLC in the United States and other countries.
- HDAVI Control™ is a trademark of Panasonic Corporation.
- “AVCHD” and the “AVCHD” logo are trademarks of Panasonic Corporation and Sony Corporation.
- Manufactured under license from Dolby Laboratories. Dolby and the double-D symbol are trademarks of Dolby Laboratories.
- Windows and Windows Vista are either registered trademarks or trademarks of Microsoft Corporation in the United States and/or other countries.
- iMovie, Mac and Mac OS are trademarks of Apple Inc., registered in the U.S. and other countries.
- QuickTime and the QuickTime logo are trademarks or registered trademarks of Apple Inc., used under license therefrom.
- This product uses “DynaFont” from DynaComware Corporation. DynaFont is a registered trademark of DynaComware Taiwan Inc.
- Other names, company names, and product names mentioned in these instructions are trademarks or registered trademarks of the companies concerned.

This product is licensed under the AVC patent portfolio license for the personal and non-commercial use of a consumer to (i) encode video in compliance with the AVC Standard (“AVC Video”) and/or (ii) decode AVC Video that was encoded by a consumer engaged in a personal and non-commercial activity and/or was obtained from a video provider licensed to provide AVC Video. No license is granted or shall be implied for any other use. Additional information may be obtained from MPEG LA, LLC.
See <http://www.mpegla.com>.

This product incorporates the following software:

- (1) the software developed independently by or for Panasonic Corporation,
- (2) the software owned by third party and licensed to Panasonic Corporation, and/or
- (3) open source software

The software categorized as (3) is distributed in the hope that it will be useful, but WITHOUT ANY WARRANTY, without even the implied warranty of MERCHANTABILITY or FITNESS FOR A PARTICULAR PURPOSE. Please refer to the detailed terms and conditions thereof displayed by selecting [MENU/SET] → [Setup] → [Version Disp.] → [Software info].