

# Hamlin- 3 Doors Robe

Assembly Instructions - Please keep for future reference

152/4877

151/4203

152/9614

hygena

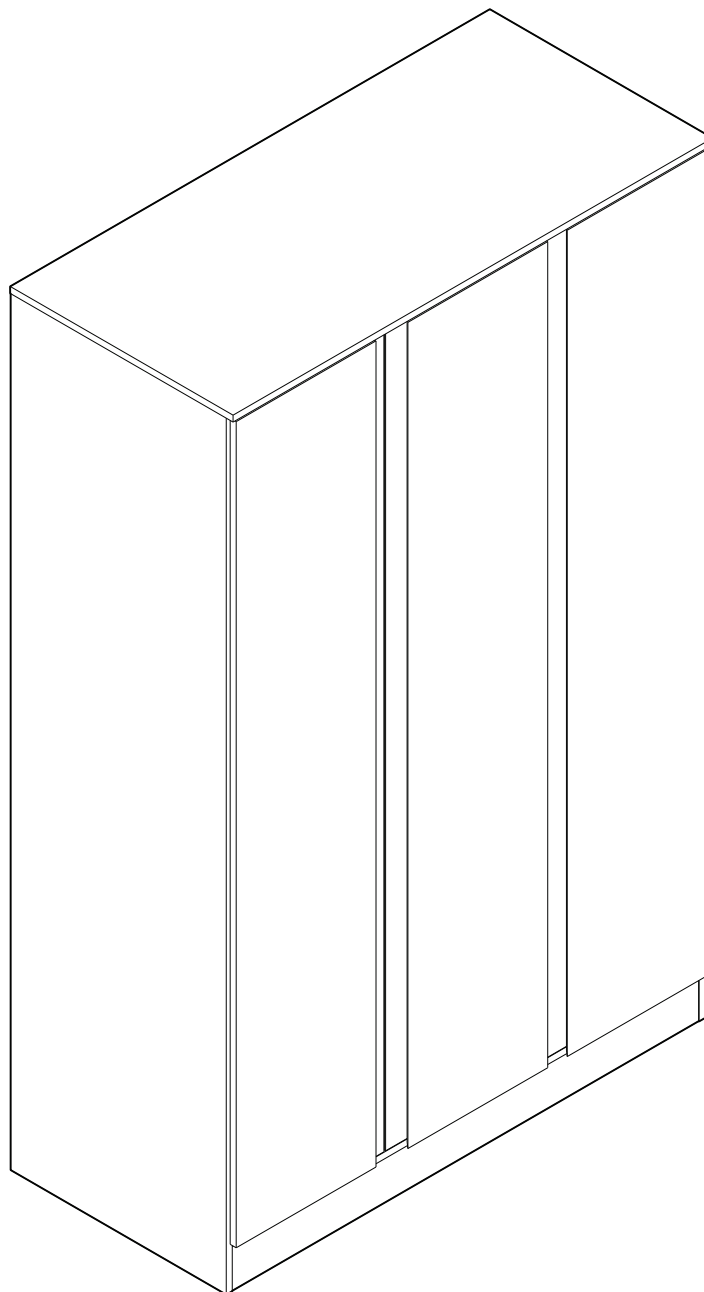

## Dimensions

Width - 120cm

Depth - 55,8cm

Height - 192cm

**Important – Please read these instructions fully before starting assembly**

If you need help or have damaged or missing parts, call the Customer Helpline: 08456 400 800



# Safety and Care Advice

**Important – Please read these instructions fully before starting assembly**

- Check you have all the components and tools listed on pages 2 and 3.
- Remove all fittings from the plastic bags and separate them into their groups.
- Keep children and animals away from the work area, small parts could choke if swallowed.
- Make sure you have enough space to layout the parts before starting.

- Do not stand or put weight on the product, this could cause damage.
- Assemble the item as close to its final position (in the same room) as possible.
- Assemble on a soft level surface to avoid damaging the unit or your floor.



• We do not recommend the use of power drill/drivers **for inserting screws**, as this could damage the unit. Only use hand screwdrivers.

- Parts of the assembly will be easier with 2 people.
- Dispose of all packaging carefully and responsibly.

## Care and maintenance

- Avoid placing the furniture in direct sunlight as this will cause the timber to prematurely age.
- Use a dry cloth to clean the product, furniture polish is not recommended.
- From time to time check that there are no loose screws on this unit.
- This product should not be discarded with household waste. Take to your local authority waste disposal centre.

**Note:** If required the next page can be cut out and used as reference throughout the assembly. Keep this page with these instructions for future reference.

# Components - Panels

Please check you have all the panels listed below

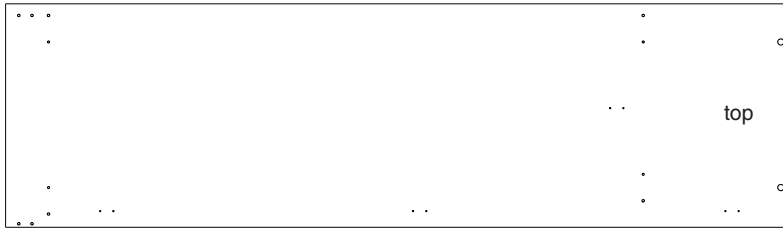

**1** Right side panel (190 x 54cm)

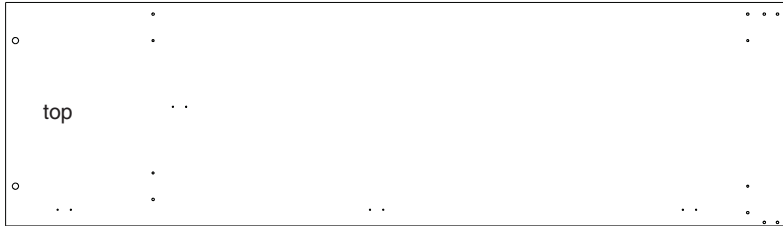

**2** Left side panel (190 x 54cm)



**3** Middle wall panel (178.8 x 54cm)

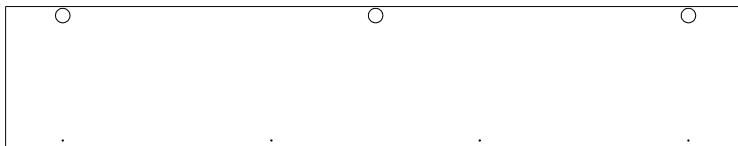

**4** Door x 3 (179 x 35cm)

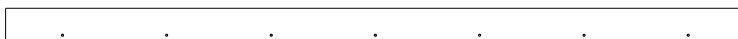

**5** Door knocker x 3 (178 x 8cm)



**6** Left back panel x 2 (180.8 x 39.1cm)



**7** Right back panel (180.8 x 40cm)



**8** H profile (179 x 1.8cm)

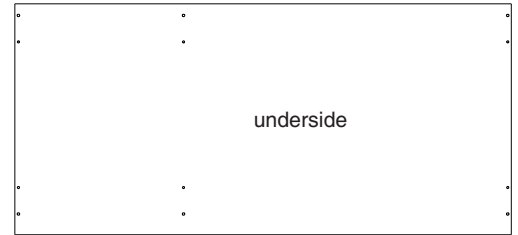

**9** Top panel (120 x 55.8cm)

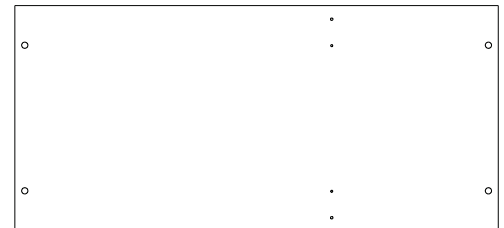

**10** Base panel (117 x 54cm)

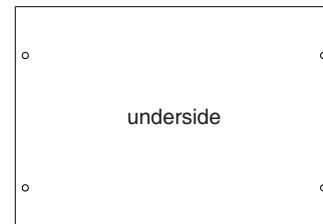

**11** Left shelf (77 x 52.7cm)

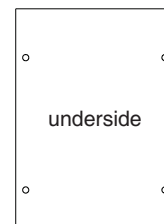

**12** Right shelf (38.5 x 52.7cm)



**13** Bottom frame (117 x 9.6cm)



**14** Unfinished bottom frame (117 x 9.6cm)

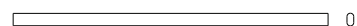

**15** Left hanging rail (76.2 x 3cm)











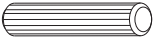
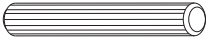
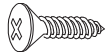

**16** Right hanging rail (37.7 x 3cm)

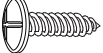
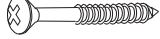
# Components - Fittings

If you have damaged or missing components, call the Customer Helpline: 08456 400 800

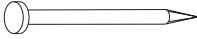
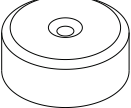
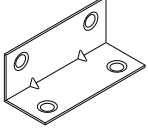
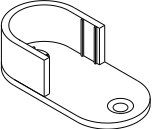
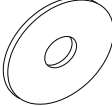
Please check you have all the fittings listed below

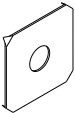
**Note:** The quantities below are the correct amount to complete the assembly. In some cases more fittings may be supplied than are required.

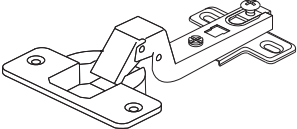
<b>A</b>  Ø 6X30 Wooden dowel x 24	<b>B</b>  Ø 6X50 Wooden dowel x 2	<b>C</b>  14mm Screw x 32
<b>D</b>  14mm Screw x 36	<b>E</b>  16mm Screw x 1	<b>F</b>  25mm Screw x 21
<b>G</b>  Metal dowel x 20	<b>H</b>  Locking nut x 20	<b>I</b>  Nail x 94
<b>J</b>  Nail x 6	<b>K</b>  Plastic feet x 6	<b>L</b>  L shaped bracket x 6
<b>M</b>  Hanging rail support x 4	<b>N</b>  Washer x 2	<b>O</b>  Plastic cap x 20
<b>P</b>  Bracket x 18	<b>Q</b>  Wall strap x 1	<b>R</b>  Door hinge x 9

## Tools required

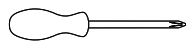

Phillips screwdriver  
(small & medium)

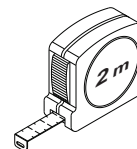

Ruler/tape  
measure

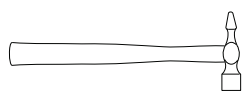

Small  
hammer

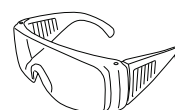

Eye protection  
(when using a  
hammer or glue)

Ruler - Use this ruler to help correctly identify the screws

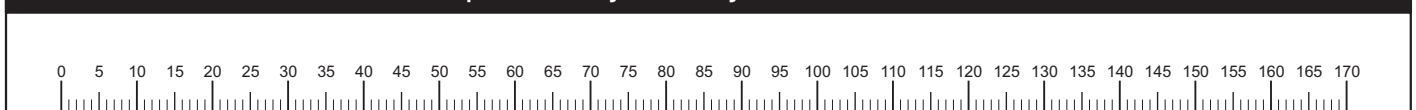

# Assembly Instructions

## Step 1

Insert dowels **A** into the indicated parts.

Fix hanging rail support **M** in the pre marked holes on right side panel **1** and left side panel **2** using screws **C**, as shown.

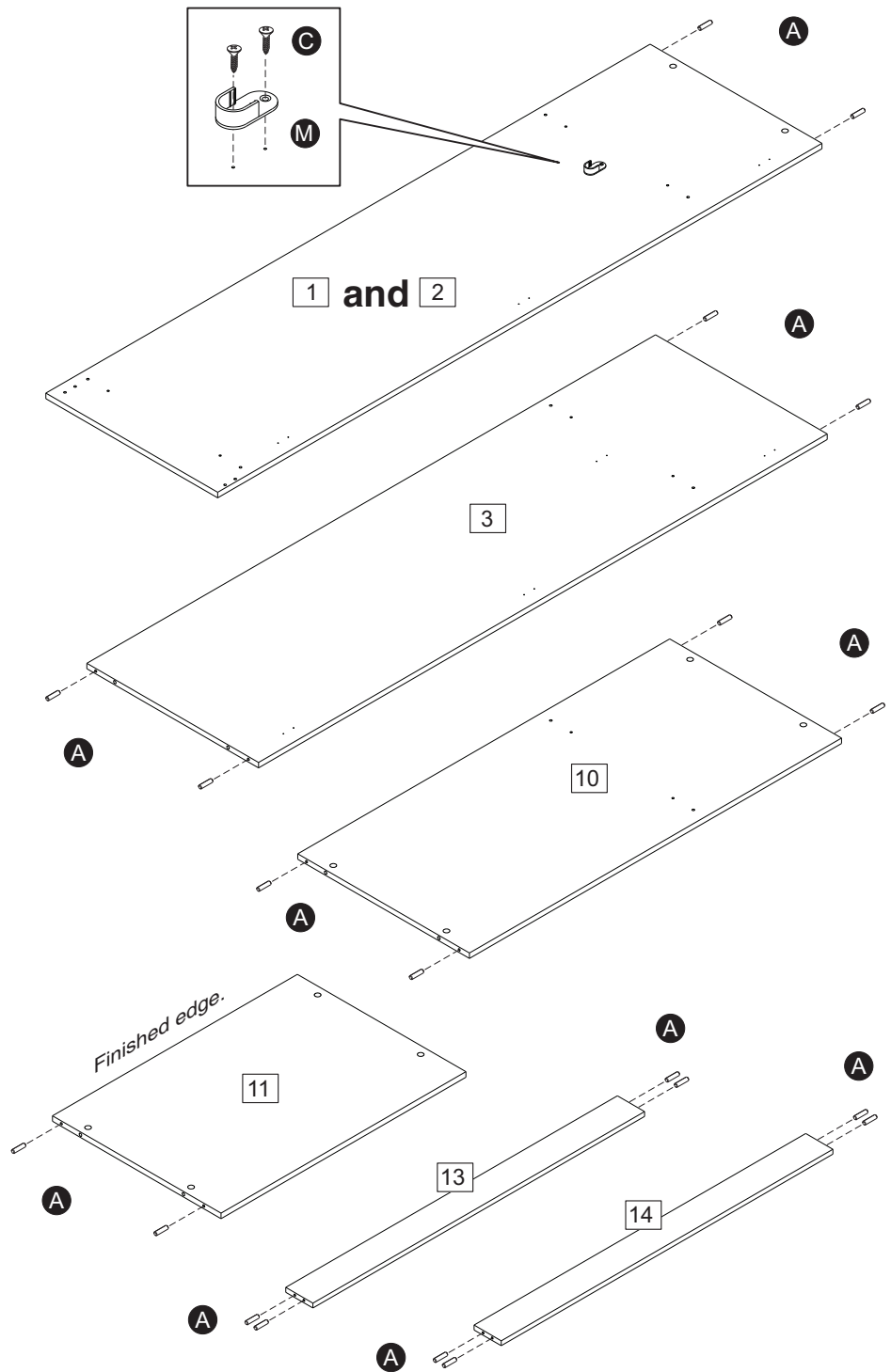

## Step 2

Insert dowels **A** and **B** into right shelf **12** as shown.

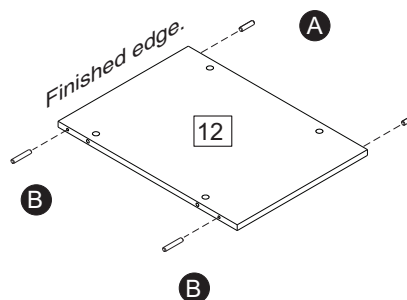

# Assembly Instructions

## Step 3

### Fitting hinges.

**a:** Loosen screw in door hinge **R** and separate the 'back plate'.

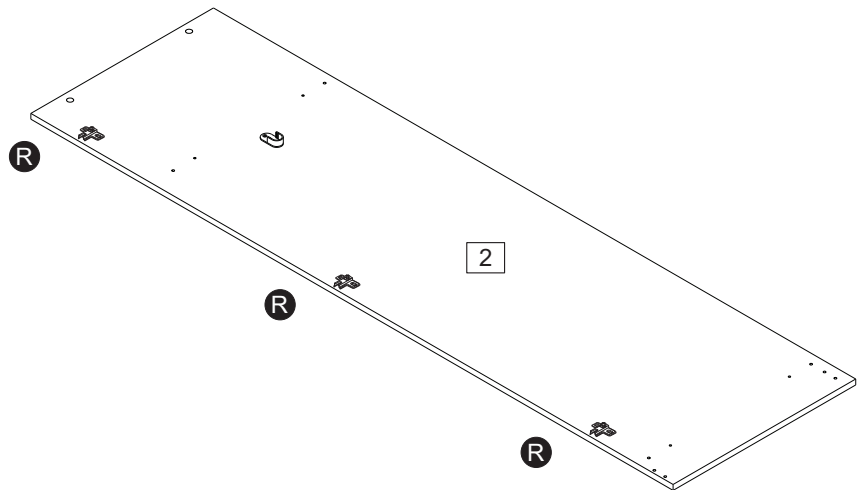
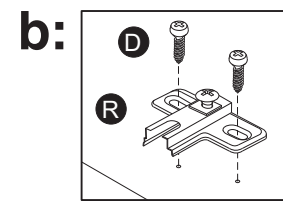
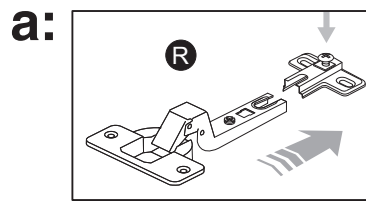

**b:** Attach 'back plates' **R** in the pre marked holes on right and left side panels **1** and **2** using screws **D**.

Attach 'back plates' **R** in the pre marked holes on middle wall panel **3** using screws **D**.

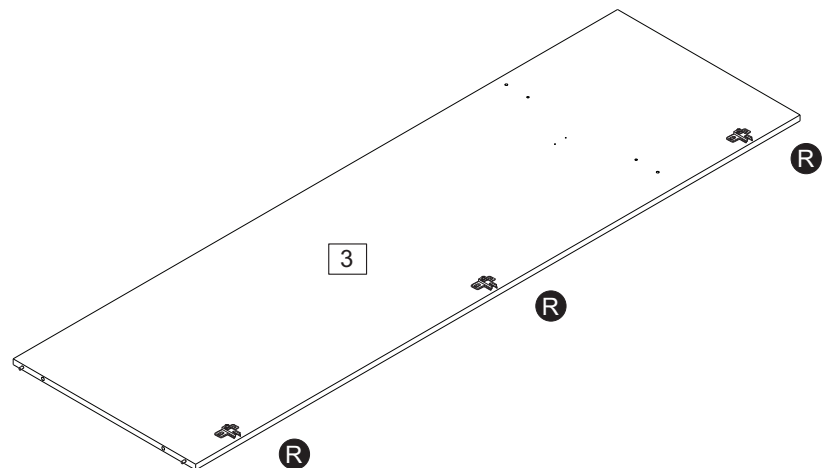
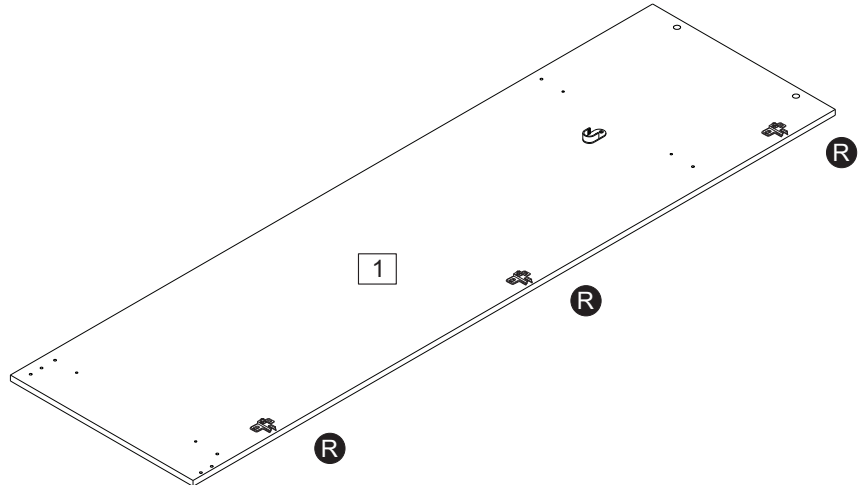

# Assembly Instructions

## Step4

### Fitting Metal dowels.

Screw metal dowels **G** into right side panel **1**, left side panel **2**, top panel **9** and base panel **10**.



**Note:** Insert metal dowels as far as shown.

**Do not over tighten.**

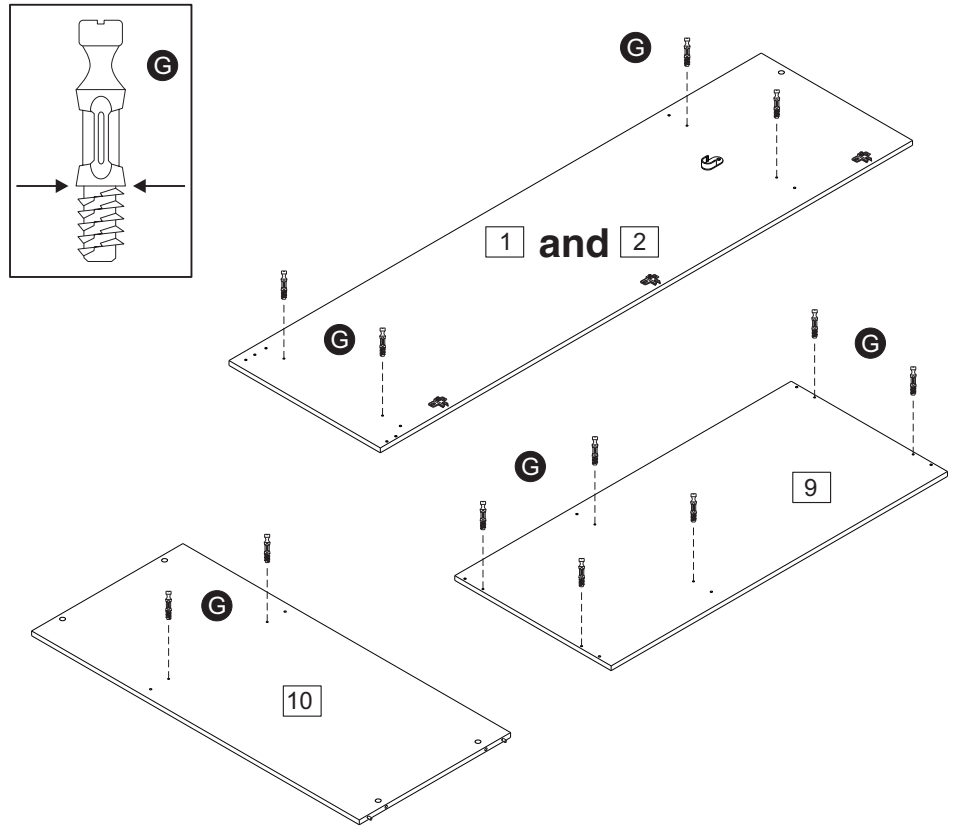

## Step5

### Fitting Metal dowels and hanging rail support.

Fix hanging rail support **M** in the pre marked holes on both sides of middle wall panel **3** using screws **C**, as shown.

Screw metal dowels **G** into both sides of middle wall panel **3**.



**Note:** Insert metal dowels as far as shown.

**Do not over tighten.**

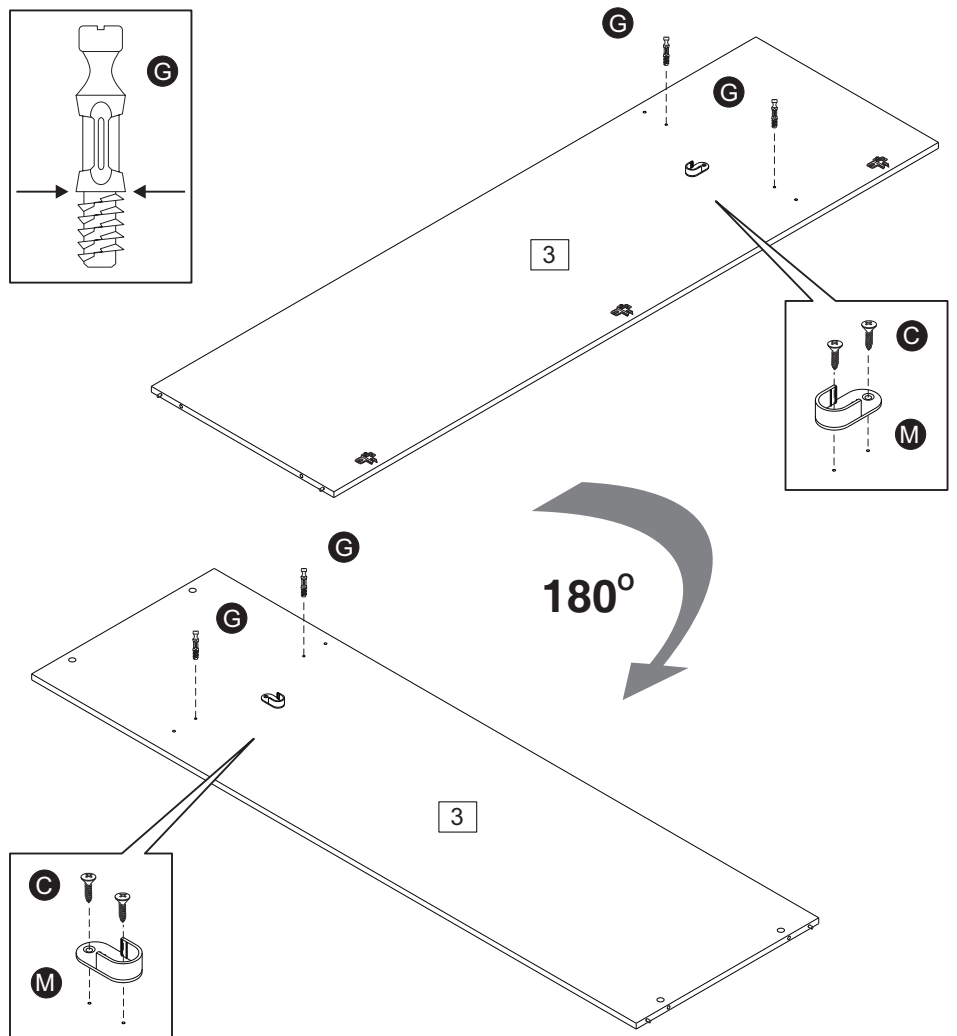

# Assembly Instructions

## Step 6

### Fixing L shaped brackets.

Fix L shaped brackets **L** in the bottom frame **13** and unfinished bottom frame **14** using screws **C**, as shown.

**Attention:** Leave **1mm** gap from the edge of the bars as shown. Fix L shaped brackets to the unfinished side in bottom frame **13**.

Unfinished side to face up.

**Attention:**

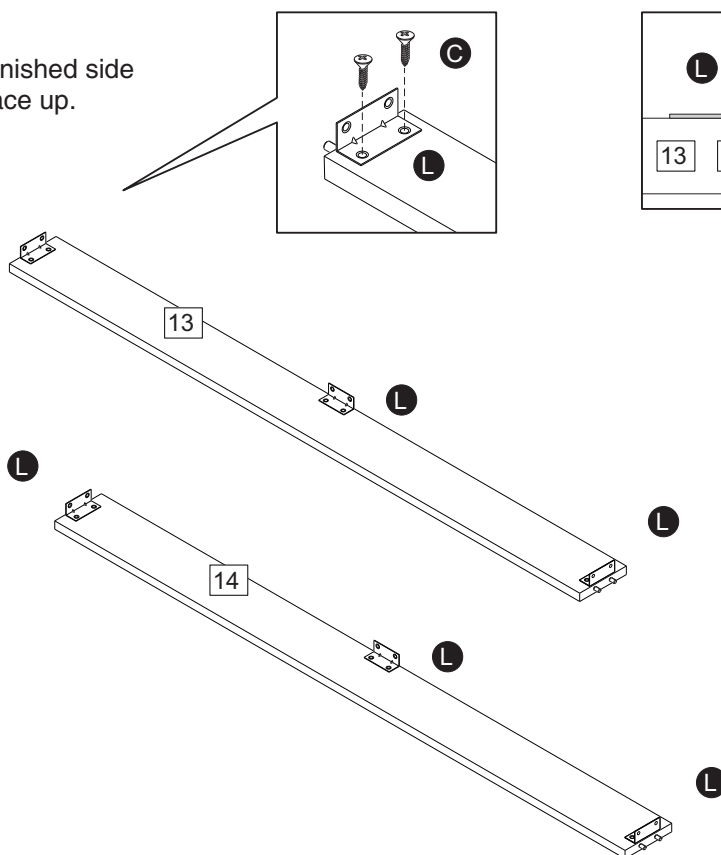
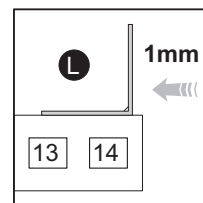

## Step 7

### Fixing base panel.

With help, fit base panel **10** to middle wall panel **3**.

Insert 2 locking nuts **H** into middle wall panel where shown.

Use a screwdriver to turn locking nuts **H** clockwise to lock.

**Do not over tighten.**

After screwing locking nuts, insert plastic caps **O**.

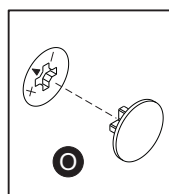
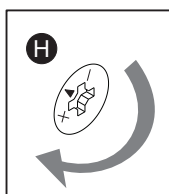
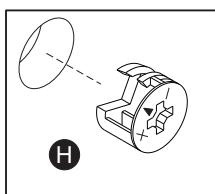
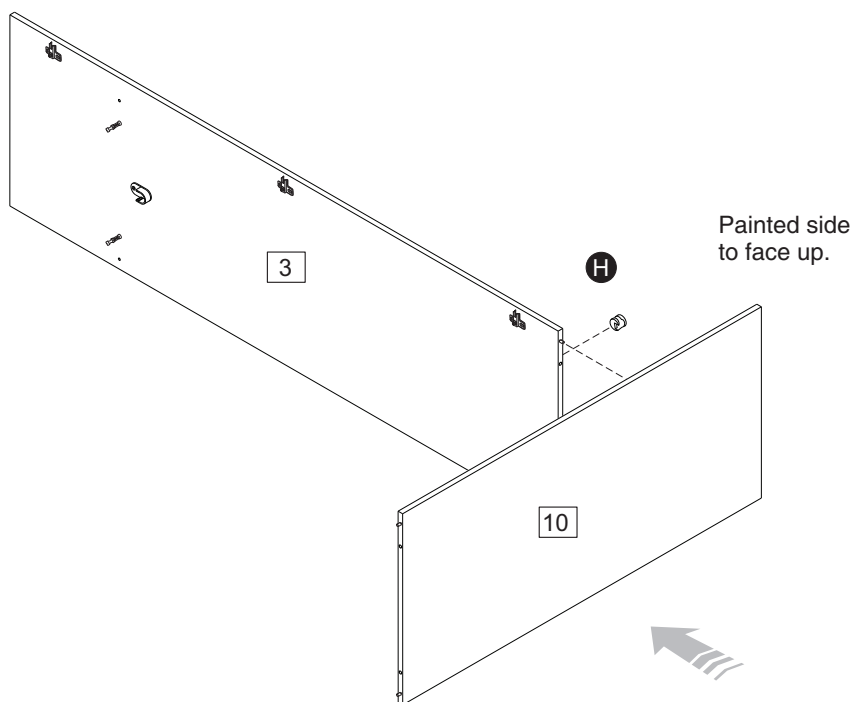



# Assembly Instructions

## Step 8

### Fixing shelves.

With help, fit left shelf **11** and right shelf **12** to middle wall panel **3**.



#### Attention!

Right shelf with longer wooden dowel should be fitted on the right side and painted edge on shelves to be facing up.

Insert 4 locking nuts **H** into shelves where shown

Use a screwdriver to turn locking nuts **H** clockwise to lock.

**Do not over tighten.**

After screwing locking nuts, insert plastic caps **O**.

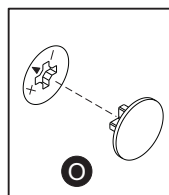
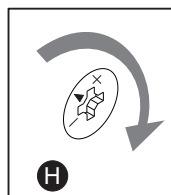
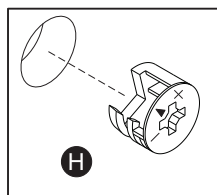
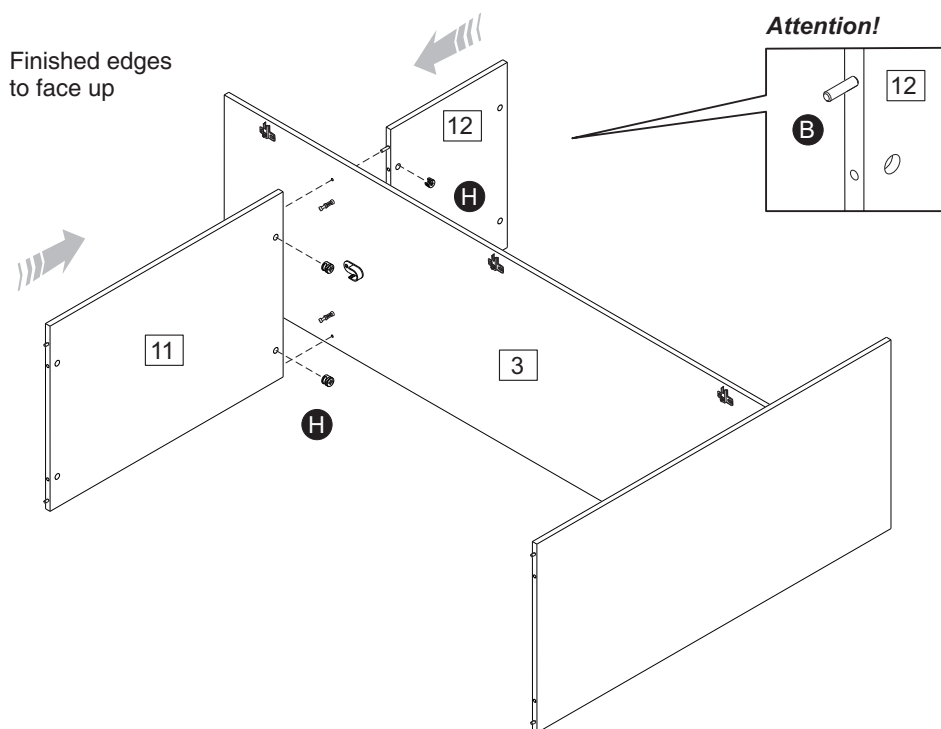

## Step 9

### Fixing right side panel.

Place right side panel **1** properly ensuring dowels are all fitted into their holes at the same time.

Insert 4 locking nuts **H** into base panel and right shelf where shown.

Use a screwdriver to turn locking nuts **H** clockwise to lock.

**Do not over tighten.**

After screwing locking nuts, insert plastic caps **O**.

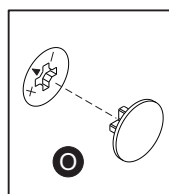
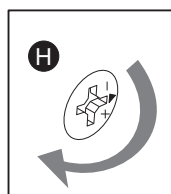
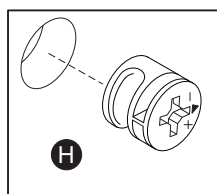
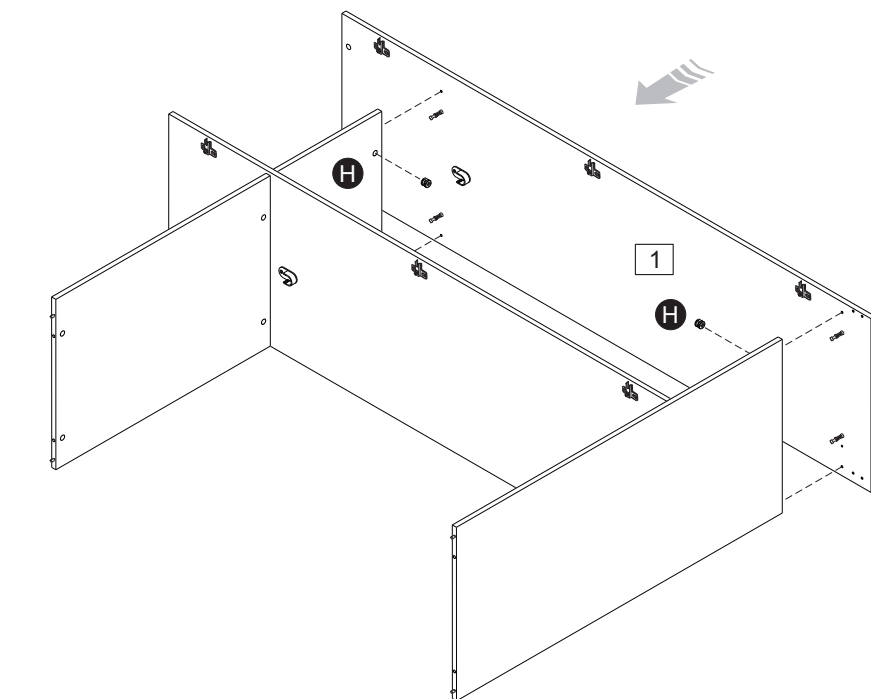

# Assembly Instructions

## Step 10

### Fixing left side panel.

Two people are required for an easier assembly.

Fit bottom frames **13** and **14** and then, place left side panel **2** properly ensuring dowels and bottom frames are all fitted into their holes at the same time.

Make sure bottom frames **13** and **14** are positioned as indicated in the picture.

Insert 4 locking nuts **H** into base panel and shelf where shown.

Use a screwdriver to turn locking nuts **H** clockwise to lock.

**Do not over tighten.**

After screwing locking nuts, insert plastic caps **O**.

Fix bottom frames **13** and **14** in the side panels and base panel through L shaped brackets **L** using screws **C**.

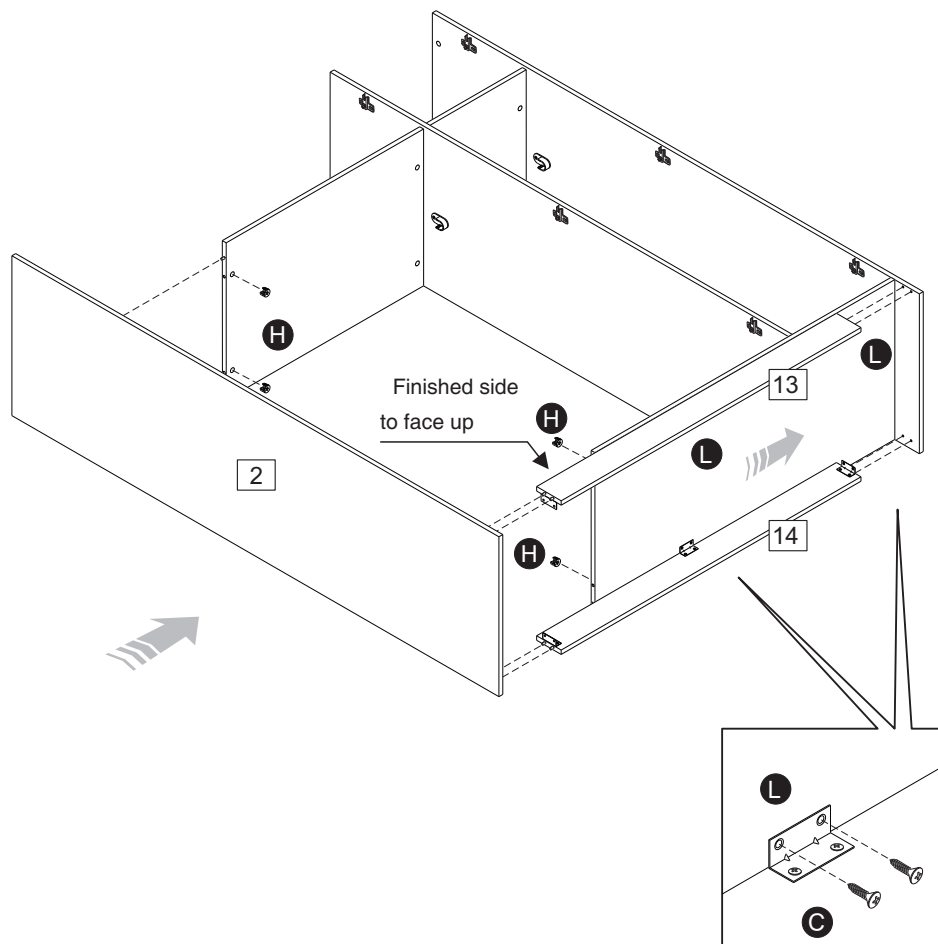
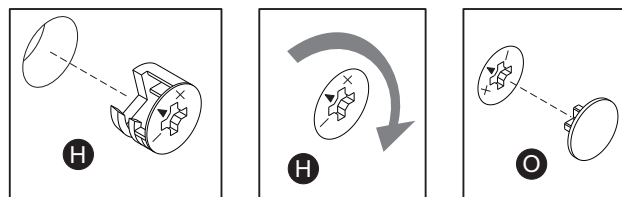

# Assembly Instructions

## Step 11

### Fixing top panel.

With help, fit top panel **9** to the cabinet.

Insert 6 locking nuts **H** into side panels and middle wall panel where shown.

Use a screwdriver to turn locking nuts **H** clockwise to lock.

**Do not over tighten.**

After screwing locking nuts, insert plastic caps **O**.

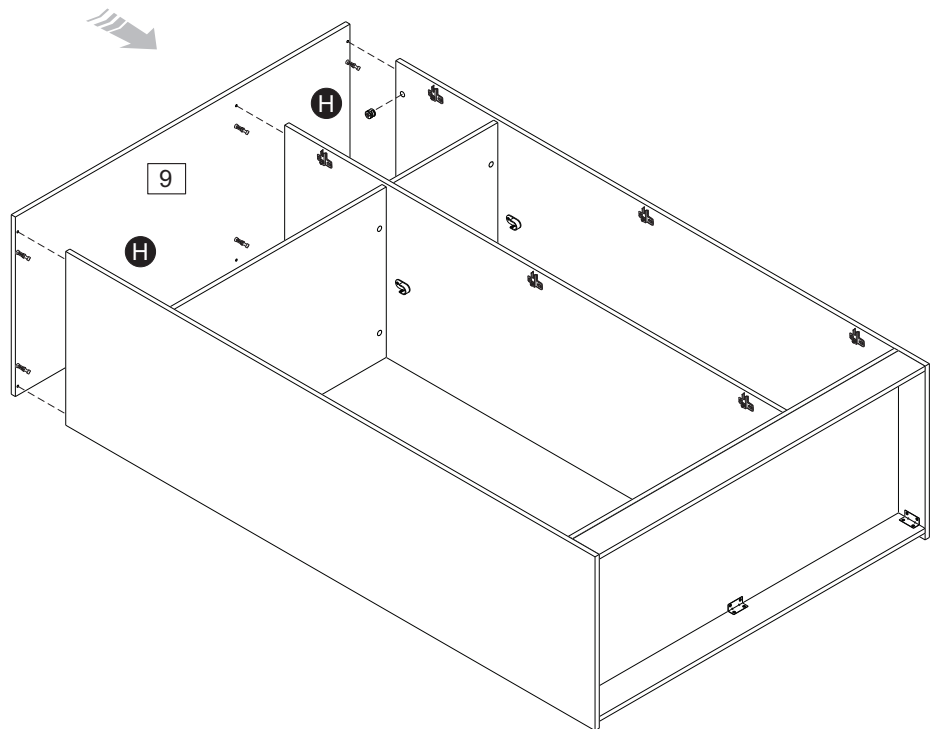
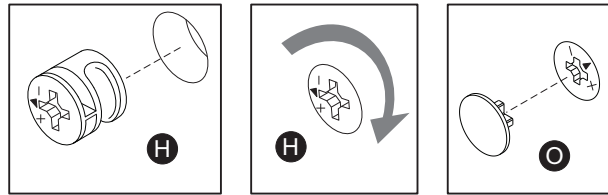

# Assembly Instructions

## Step 12

### Attach plastic feet.

Attach plastic feet **K** in the bottom edge of the side panels and bottom frames using nails **J**.



Make sure nails are fully nailed.

After attaching plastic feet, with help, carefully stand the product upright.

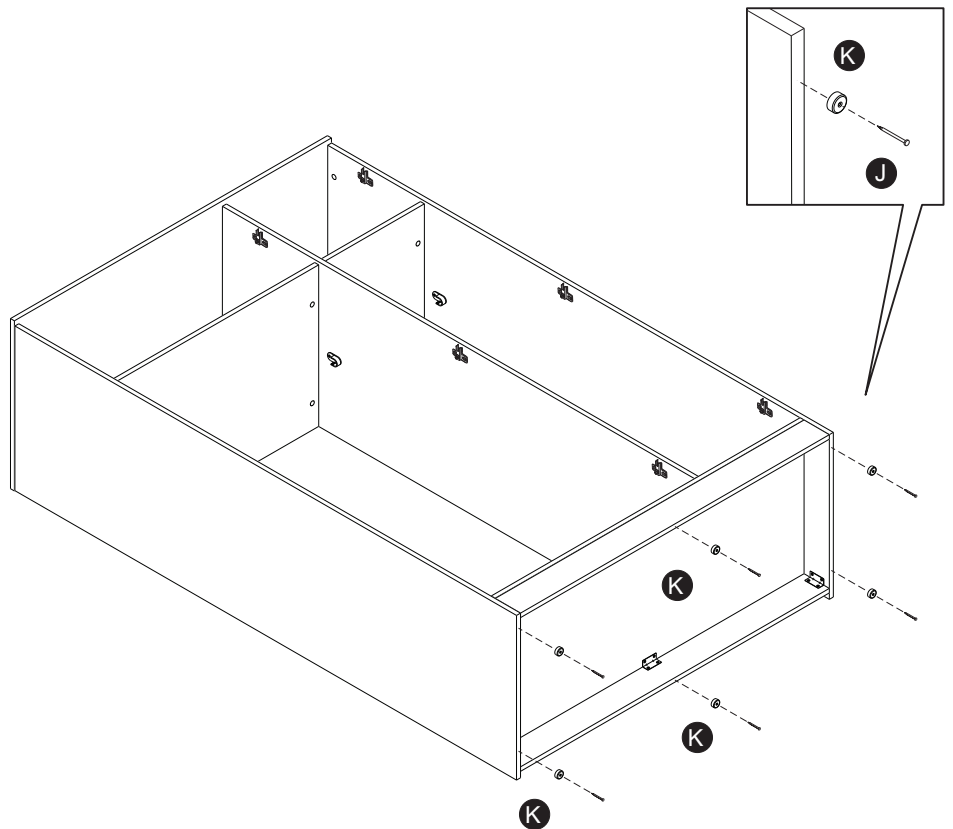

## Step 13

Insert hanging rails **15** and **16** into the supports **M**.

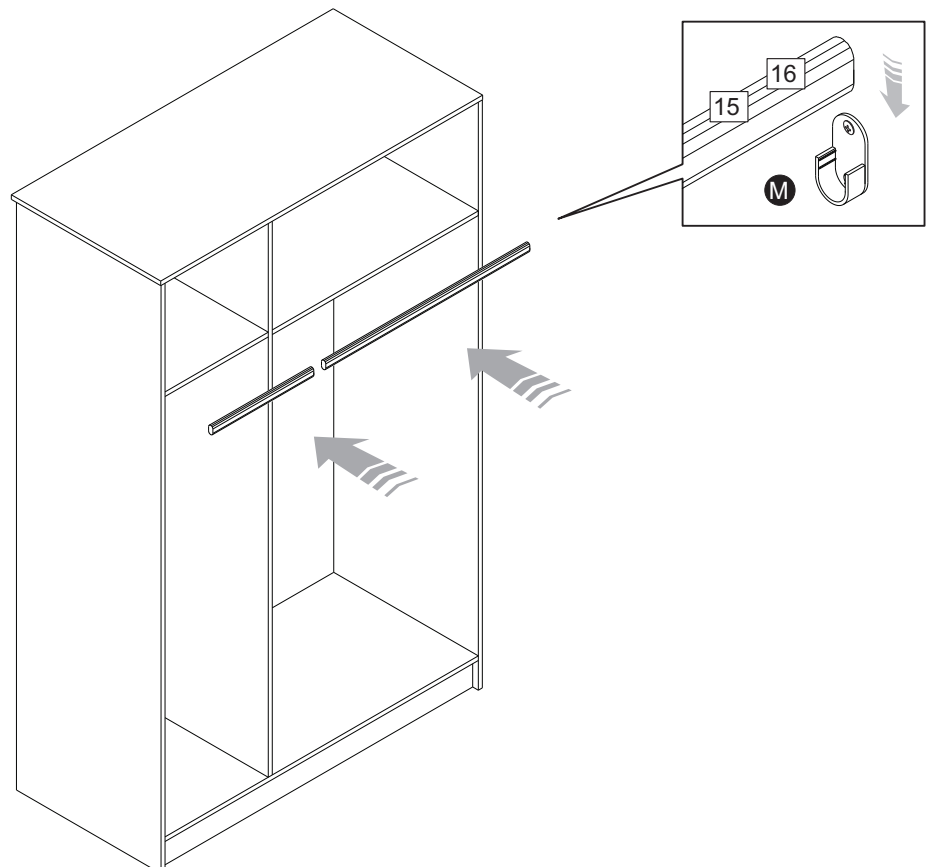

# Assembly Instructions

## Step 14

### Fixing back panels.



#### **Important:**

Cabinet **MUST** be 'square' when back panels are attached. Make sure back panels are in flush with the edge of the top panel prior to fixing.

**a:** Attach the left back panel **6** first using nails **1**.

#### **Note:**

Back panel's finished side to face inside.

**b:** Position profile **8** onto back panel (just attach).

**c:** Carefully slot the second back panel **6** into the profile and fix it to the cabinet using nails **1**.

**d:** Attach right back panel **7** using nails **1**.

**e:** Attach brackets **P**, ensuring it is placed part over panel **6** and part over base panel **7** using nails **1**.

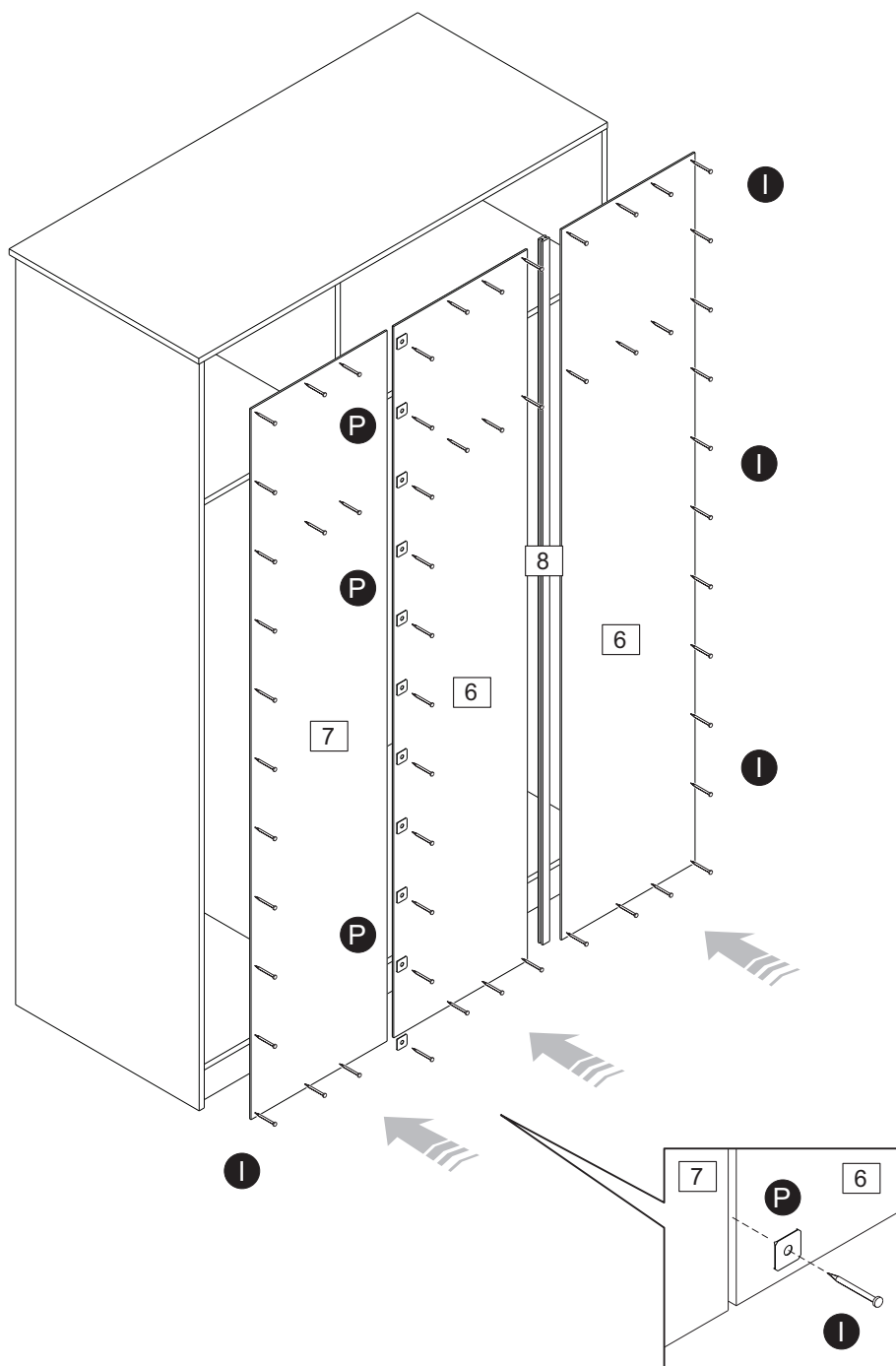
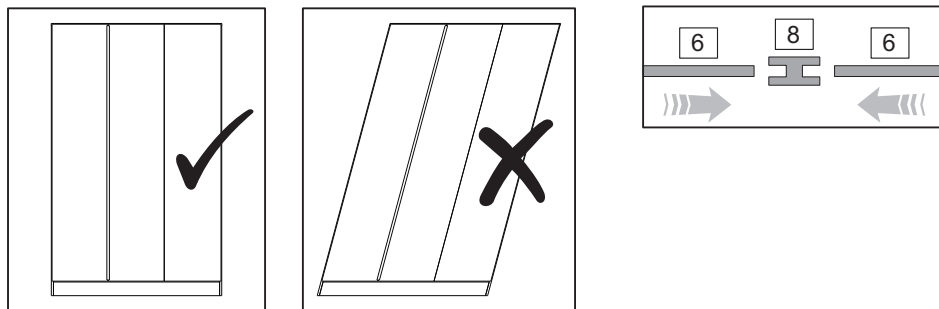

# Assembly Instructions

## Step 15

### Fitting hinges to doors.

**a:** Insert hinges **R** in the holes on door **4**, as shown.

**b:** Attach hinges **R** in the door using screws **D**, as shown.

Repeat step 15 for the other doors.

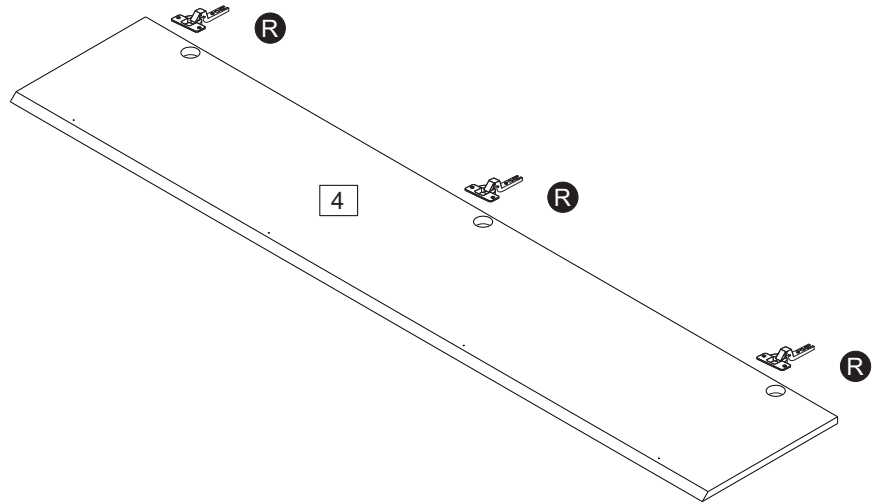
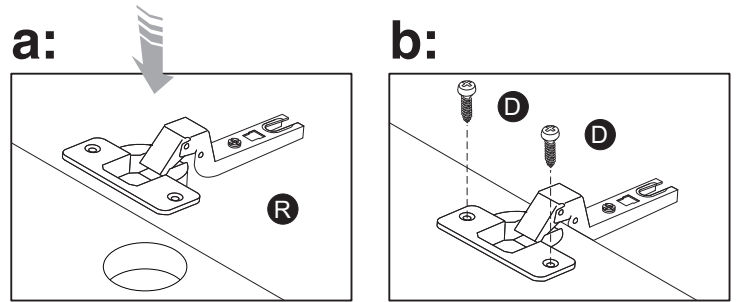

## Step 16

### Hanging doors.

**a:** With help, slot door hinges **R** onto 'hinge plates'.

**b:** Tighten screw shown to lock hinges in position.

Repeat **a** and **b** for other doors.

See 'hinge adjustment' in step 18 if the doors need adjusting.

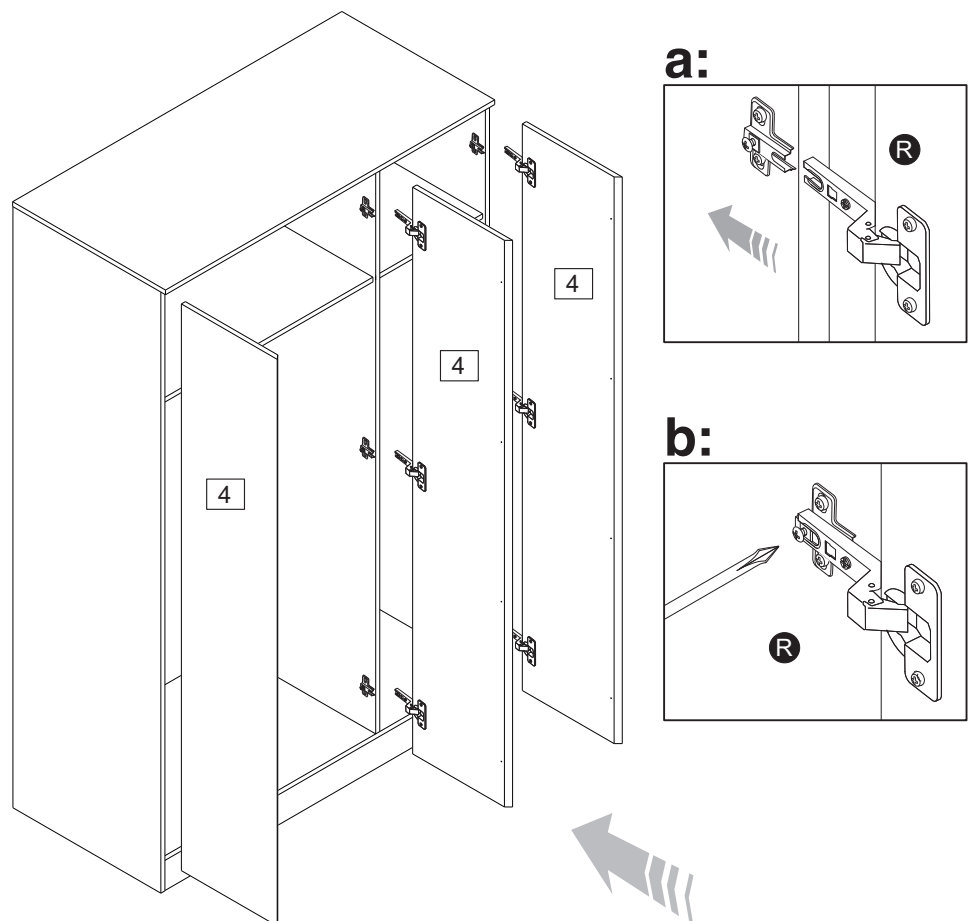

# Assembly Instructions

## Step 17

### Fixing door knocker.

Attach door knocker **5** in the pre marked holes on door using screws **F** as shown. Make sure knocker is aligned at top of door before fixing.

Repeat step 17 for the other doors.

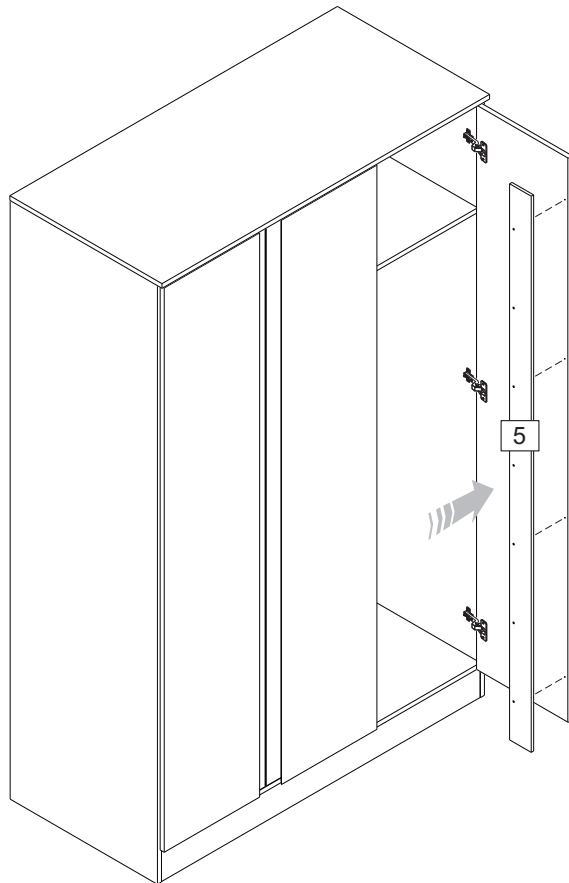

## Step 18

### Hinge adjustment.

**a:** To move doors up or down: loosen screws shown and move doors to suit.

Re-tighten screws.

**a:**

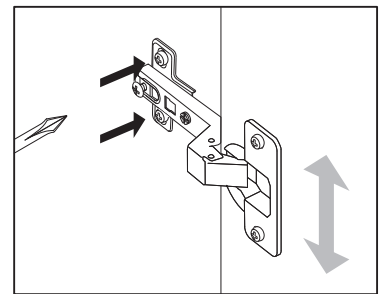
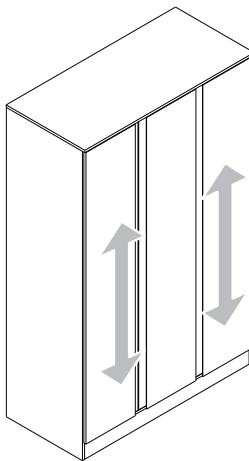

**b:** To move doors in or out: loosen screw shown and move doors to suit.

Re-tighten screws.

**b:**

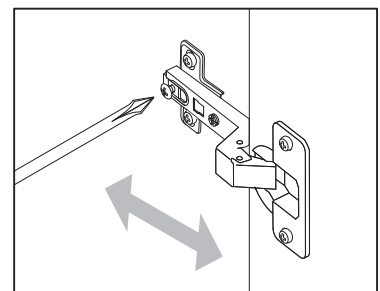
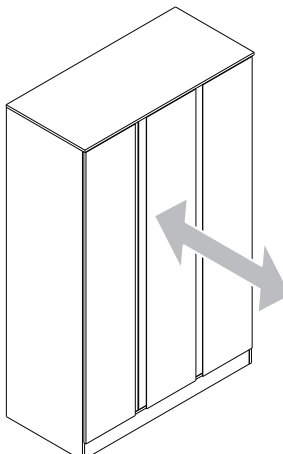

Continued on next page.

# Assembly Instructions

## Step 18 - continued

**C:** To move doors left or right: loosen screw shown and move doors to suit.

Re-tighten screws.

**C:**

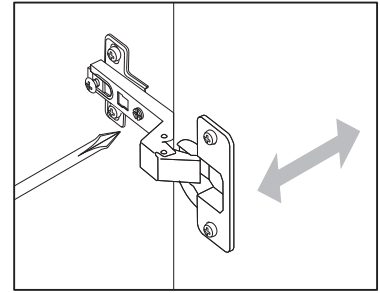
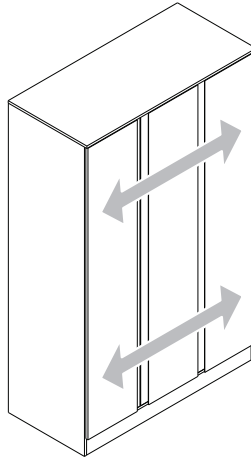

## Step 19

### Fixing to wall.

Furniture must be fixed to a wall. Fix wall strap **Q** to top of furniture using washer **N** and screw **E**. With help, move furniture into position.

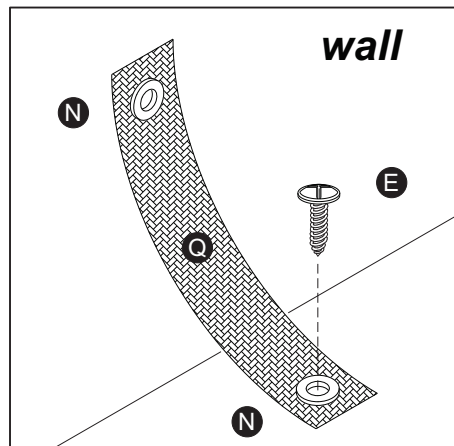

**Note:** Wall plugs not supplied. The correct type of fixing must be used for your wall, seek professional advice if in doubt.

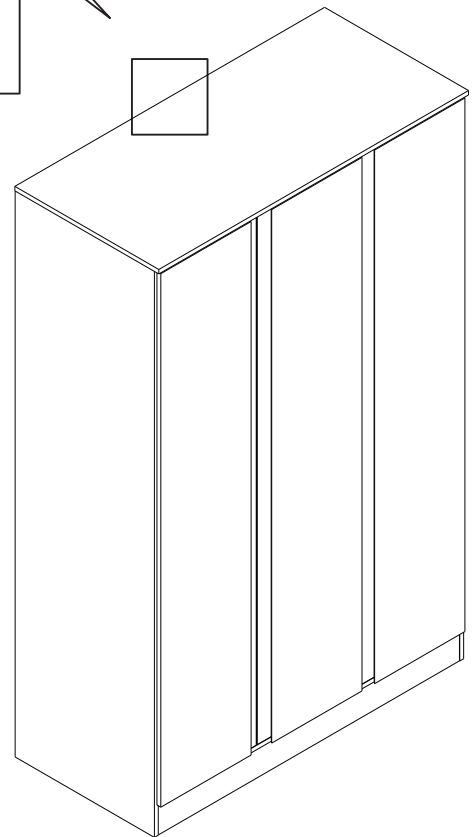

**Assembly is complete.**

If you need help or have damaged or missing parts, call the Customer Helpline: 08456 400 800



# A Guide to -Wall Mounting & Fixings

## Important note:

If plastic wall plugs are supplied with your product:



- these are only suitable for use in masonry walls.

If you are in any doubt about the correct wall plugs for your wall, seek professional advice.

Failure of the product due to using incorrect fixings is the responsibility of the installer.



**Important:** When drilling into walls always check that there are no hidden wires or pipes etc.

Make sure that the screws and wall plugs being used are suitable for supporting your unit. Consult a qualified tradesperson if you are unsure.

## Hints:

- 1: **General rule:**  Always use a larger screw and wall plug if you are not sure.
- 2: Ensure you use the recommended drill bit to match the wall plug and hole size.
- 3: Ensure you drill the hole horizontally, do not force the drill or enlarge the hole.
- 4: Take extra care when drilling high walls, ceilings and ceramic tiles. Ensure wall plugs are inserted beyond the thickness of the ceramic tiles to avoid the tiles splitting or cracking.
- 5: Ensure wall plugs are well fitted and are a tight fit in the drilled hole.

## Types of walls

You can use one of the following types of wall plug if your walls are made of brick, breeze block, concrete, stone or wood.

### No.1 "General Purpose" wall plug

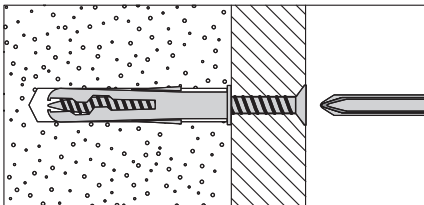

Generally aerated blocks should not be used to support heavy loads, use a specialist fitting in this case. For light loads, general purpose wall plugs can be used.

### No.2 "Plasterboard" wall plug

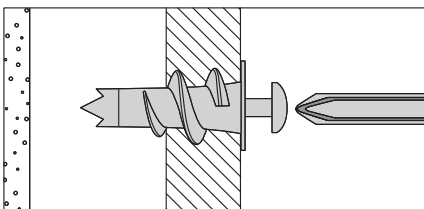

For use when attaching light loads on to plasterboard partitions.

### No.3 "Cavity Fixing" wall plug

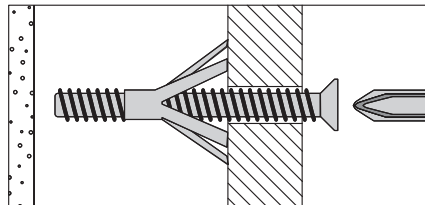

For use with plasterboard partitions or hollow wooden doors.

### No.4 "Cavity Fixing-Heavy Duty" wall plug

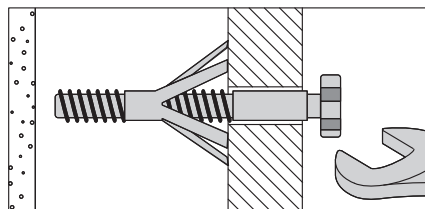

For use when fitting or supporting heavy loads such as shelving, wall cabinets and coat racks.

### No.5 "Hammer Fixing" wall plug

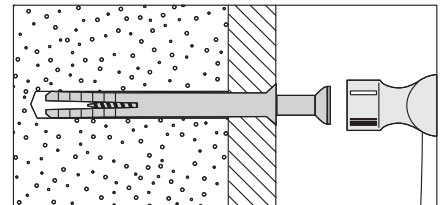

For use with walls stuck with plasterboard. The hammer fixing allows it to be fixed to the wall rather than the plasterboard. Always check the fixing is secure to the retaining wall.

### No.6 "Shield Anchor" wall plug Heavy loads

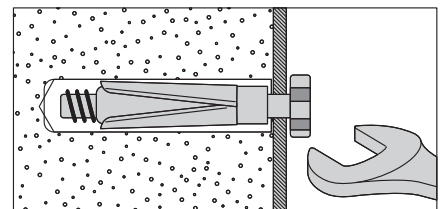

For use with heavier loads such as TV & HiFi speakers and satellite dishes etc.



**Care & Maintenance**

**Safety:** Always check the fitting and location to ensure your safety in and around the home.

**Fitting:** From time to time check the fitting to ensure the wall plugs or screws do not become loose.