

Atlas - Single Robe Carcass

Assembly Instructions - Please keep for future reference

152/9432

157/2537

157/9107

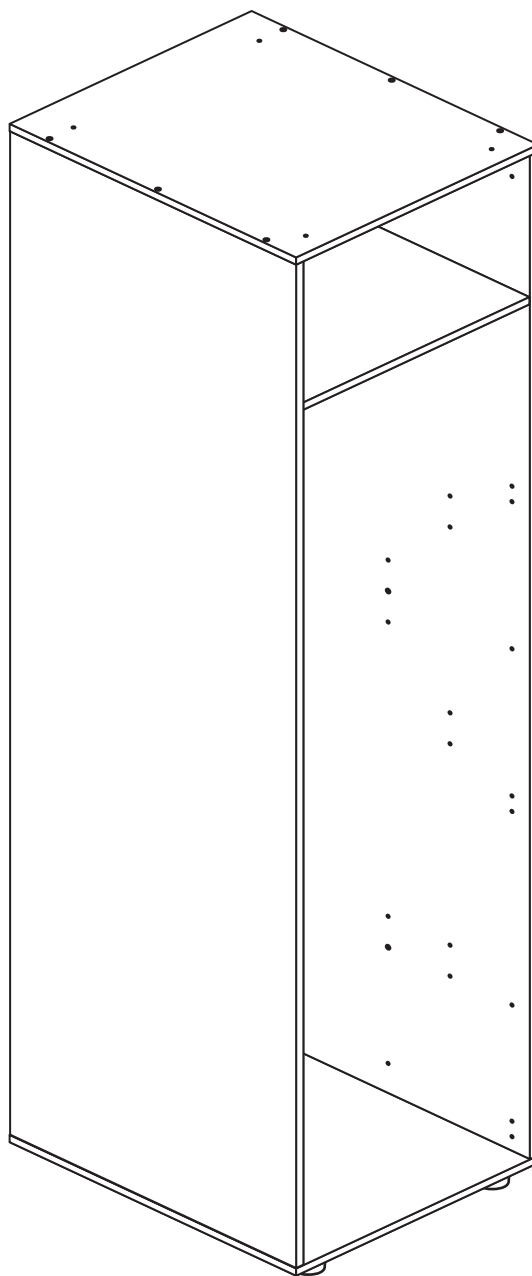

Dimensions

Width - 50cm

Depth - 59.5cm

Height - 212.5cm



**MADE IN
BRITAIN**

Important - Please read these instructions fully before starting assembly

If you need help or have damaged or missing parts, call the **Customer Helpline: 08456 400800**



Safety and Care Advice

Important - Please read these instructions fully before starting assembly

- **Warning:** This unit weighs approximately 34kgs. Please lift with care.

- Check you have all the components and tools listed on pages 2 and 3.

- Remove all fittings from the plastic bags and separate them into their groups.

- Keep children and animals away from the work area, small parts could choke if swallowed.

- Parts of the assembly will be easier with 2 people.

- Make sure you have enough space to layout the parts before starting.

- Do not stand or put weight on the product, this could cause damage.

- Assemble the item as close to its final position (in the same room) as possible.

- Assemble on a soft level surface to avoid damaging the unit or your floor (use opened out unit carton).



- We do not recommend the use of power drill/drivers **for inserting screws**, as this could damage the unit. Only use hand screwdrivers.

- **Safety note:** It is recommended that this unit is secured to a wall using the bracket supplied.

- Dispose of all packaging carefully and responsibly.

Care and maintenance

- Only clean using a damp cloth and mild detergent, do not use bleach or abrasive cleaners.

- From time to time check that there are no loose screws on this unit.

- This product should not be discarded with household waste. Take to your local authority waste disposal centre.

Note: If required the next page can be cut out and used as reference throughout the assembly. Keep this page with these instructions for future reference.

Components - Panels

If you have damaged or missing components, call the
Customer Helpline: 08456 400800 quoting the reference
numbers below

Please check you have all the panels listed below

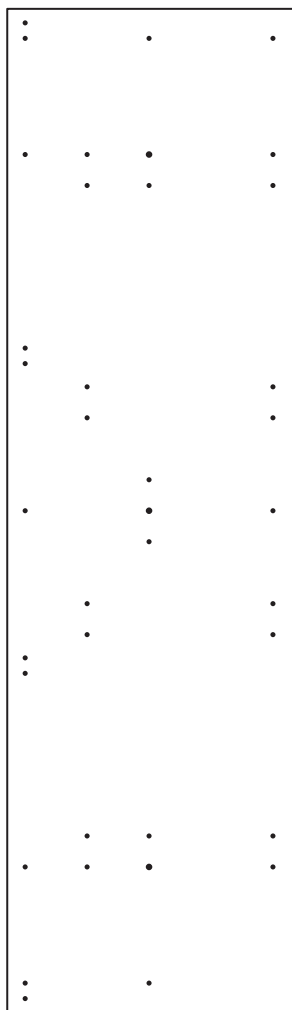

1 Universal End (D2396A)
(2074 x 591mm) x 2

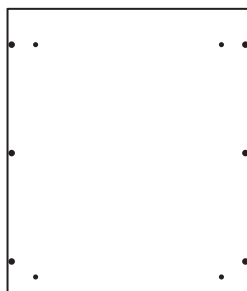

2 Top/Base (D2399A)
(500 x 592mm) x 2

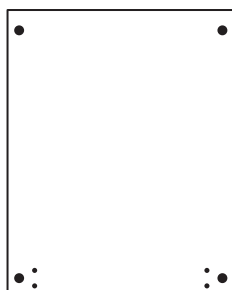

3 Fixed Shelf (D2401A)
(468 x 590mm)



4 Hanging Rail (FHR460)
(460mm long) x 2



5 Back (X2100-494)
(2100 x 494mm)









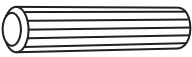
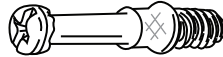

Components - Fittings

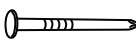



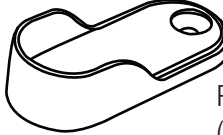
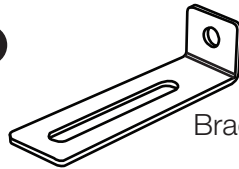
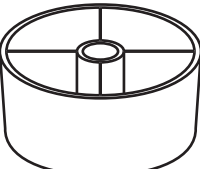
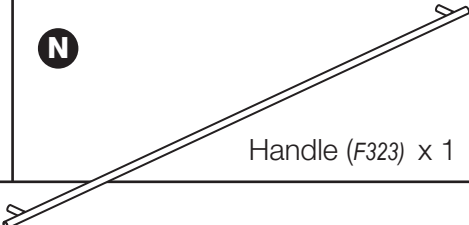
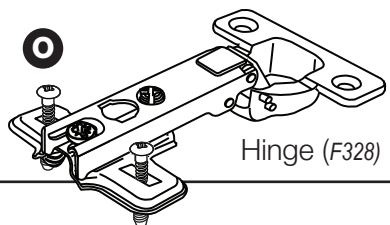

If you have damaged or missing components, call the **Customer Helpline: 08456 400800** quoting the reference numbers below

Please check you have all the fittings listed below

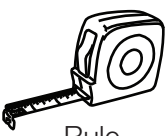
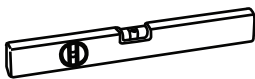
Note: The quantities below are the correct amount to complete the assembly. In some cases more fittings may be supplied than are required.

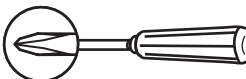
<p>A </p> <p>Wooden dowel (F22) x 2</p>	<p>B </p> <p>Metal dowel (F901) x 4</p>	<p>C </p> <p>Large locking nut (F900) x 4</p>
<p>D </p> <p>Nail (F51) x 33</p>	<p>E </p> <p>Allen Key (F36) x 1</p>	<p>F </p> <p>50mm Screw (F49) x 12</p>
<p>G </p> <p>25mm Screw (F50) x 4</p>	<p>H </p> <p>19mm Screw (F461) x 2</p>	<p>I </p> <p>13mm Screw (F79) x 1</p>
<p>J </p> <p>13mm Screw (F63) x 16</p>	<p>K </p> <p>Rail Holder (F891) x 4</p>	<p>L </p> <p>Bracket (F327) x 1</p>
<p>M </p> <p>Feet (F854) x 4</p>	<p>N </p> <p>Handle (F323) x 1</p>	<p>O </p> <p>Hinge (F328) x 4</p>

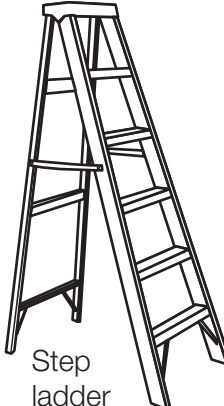
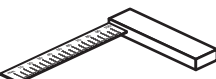
Tools required

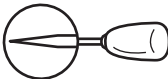
<p></p> <p>Rule</p>	<p></p> <p>Spirit level</p>	<p></p> <p>Eye protection (when using a hammer or drill)</p>	<p></p> <p>Cross-head screwdriver</p>	<p></p> <p>Electric drill (only use when drilling into walls)</p>	<p></p> <p>Step ladder</p>
<p></p> <p>Square</p>	<p></p> <p>Scissors</p>	<p></p> <p>Hammer</p>	<p></p> <p>Bradawl</p>		

Ruler - Use this ruler to help correctly identify the screws

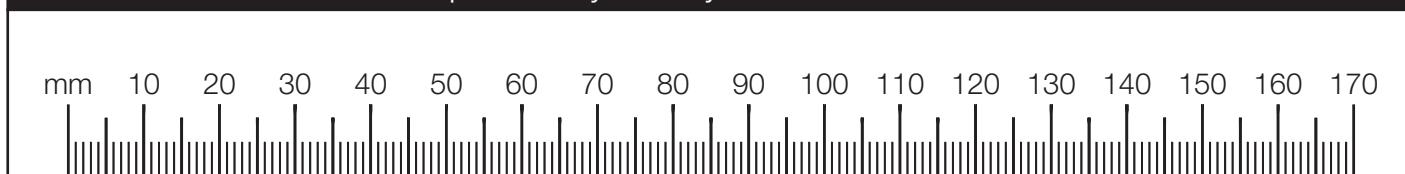

Assembly Instructions

If you have damaged or missing components, call the **Customer Helpline: 08456 400800** quoting the reference numbers below

Step 1

Are you fitting 1 or 2 Hanging Rails or, an Internal Chest or, a Shelf Pack?

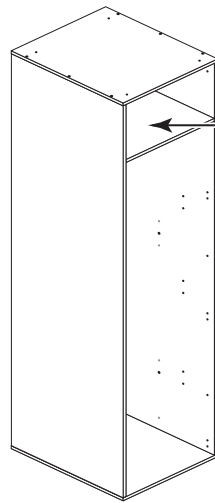

The fixed shelf will need to go here if you are fitting the following:-

Only 1 Hanging Rail
or
An Internal Chest
or
A Shelf Pack

Follow Steps 2 and 3.

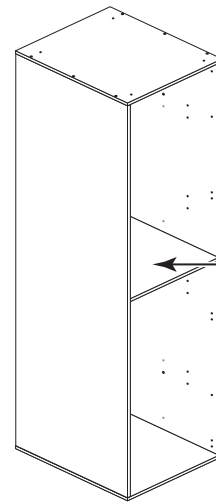

The fixed shelf will need to go here if you are fitting the following:-

2 Hanging Rails

Follow Steps 4 and 5.

Step 2

Prepare the left end

Refer to step 1 and, if you have chosen to fit 1 hanging rail or, an internal chest or, a shelf pack, screw 2 metal dowels **B** into the left end **1**.

Note: Tighten the metal dowels up fully against the panels.

Note: If you have purchased a shelf pack, do not fit the rail holder.

To fit the rail holder **K**, screw through its top hole with screw **J** and into the shallow mark hole drilled in the left end **1**. Make sure that it is fitted straight, in line with the panel edges and then fit another screw **J**

Only follow Steps 2 and 3 if you are only fitting 1 hanging rail or, an internal chest or, a shelf pack. If you are fitting 2 hanging rails, follow Step 4 and 5.

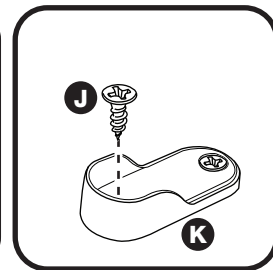
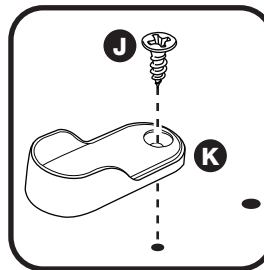
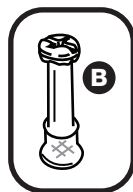

Note: If you have purchased a shelf pack, do not fit the rail holder.

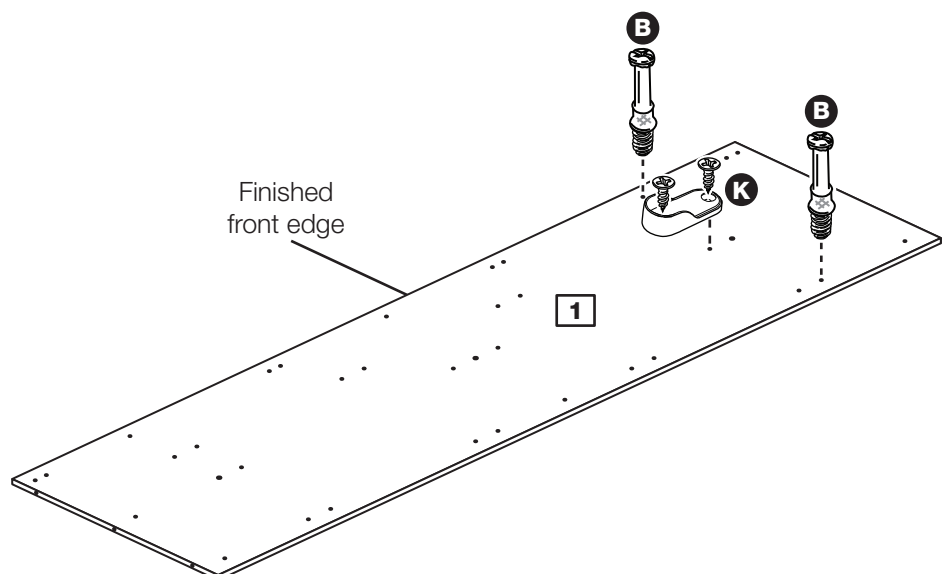

Assembly Instructions

Step 3

Prepare the right end

Refer to step 1 and, if you have chosen to fit 1 hanging rail or, an internal chest or, a shelf pack, screw 2 metal dowels **B** into the right end **1**.

Note: Tighten the metal dowels up fully against the panels.

To fit the rail holder **K**, screw through its top hole with screw **J** and into the shallow mark hole drilled in the right end **1**. Make sure that it is fitted straight, in line with the panel edges and then fit another screw **J** using the lower hole.

Only follow Steps 2 and 3 if you are only fitting 1 hanging rail or, an internal chest or, a shelf pack. If you are fitting 2 hanging rails, follow Step 4 and 5.

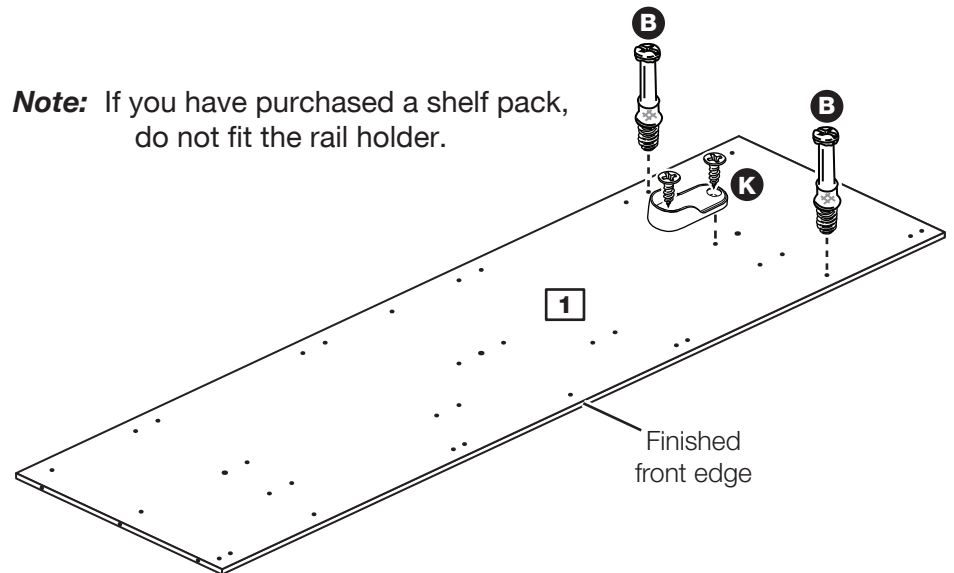

Step 4

Prepare the left end

Refer to step 1 and, if you have chosen to fit 2 hanging rails, screw 2 metal dowels **B** into the left end **1**.

Note: Tighten the metal dowels up fully against the panels.

To fit the 2 rail holders **K** screw through the top hole with screw **J** and into the shallow mark hole drilled in the left end **1**. Make sure that they are fitted straight, in line with the panel edges and then fit another screw **J** using the lower hole.

Only follow Steps 4 and 5 if you are fitting 2 hanging rails. If you are just fitting 1 rail, follow Step 2 and 3.

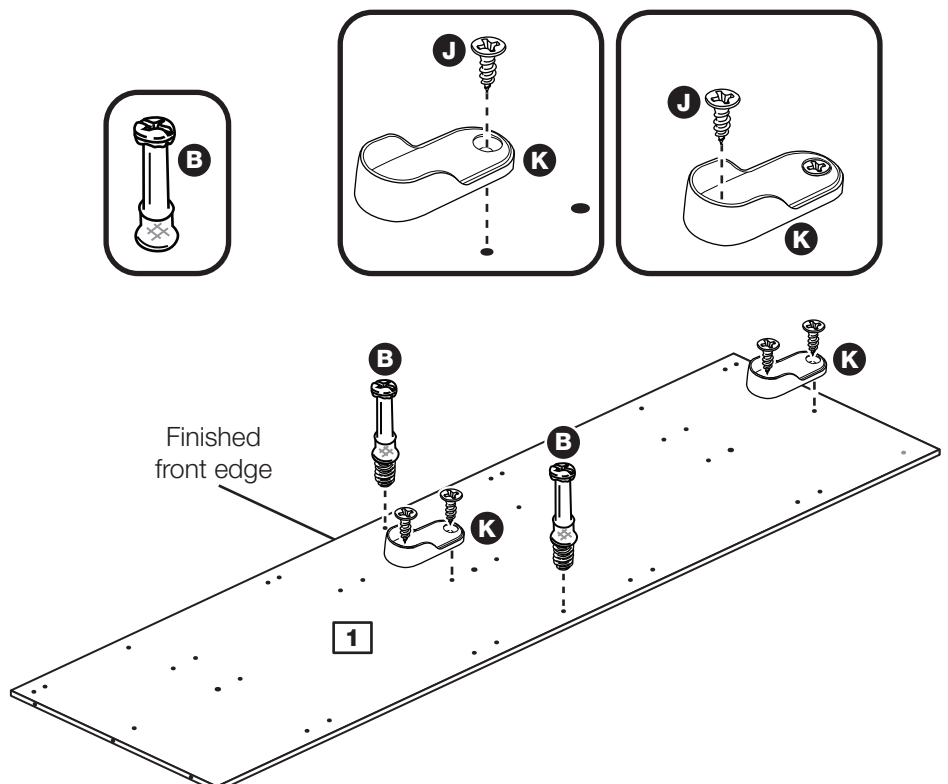

Assembly Instructions

Step 5

Prepare the right end

Refer to step 1 and, if you have chosen to fit 2 hanging rails, screw 2 metal dowels **B** into the right end **1**.

Note: Tighten the metal dowels up fully against the panels.

To fit the 2 rail holders **K** screw through the top hole with screw **J** and into the shallow mark hole drilled in the right end **1**. Make sure that they are fitted straight, in line with the panel edges and then fit another screw **J** using the lower hole.

Only follow Steps 4 and 5 if you are fitting 2 hanging rails.
If you are just fitting 1 rail, follow Step 2 and 3.

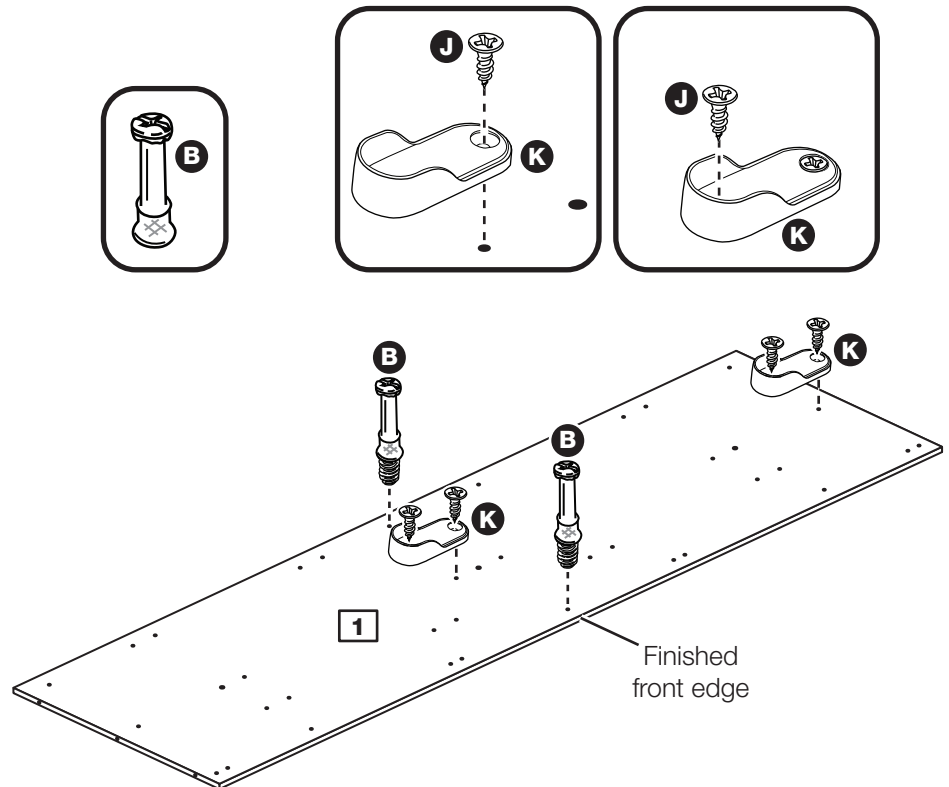

Step 6

Prepare the fixed shelf

Tap 2 wooden dowels **A** into the fixed shelf **3**.

Note: Wooden dowels **must not** stick out from the edge by more than 10mm or they may damage other panels.

Insert 4 large locking nuts **C** into the fixed shelf **3**.

Note: The arrow on the locking nut **must** point towards the hole in the edge of the panel.

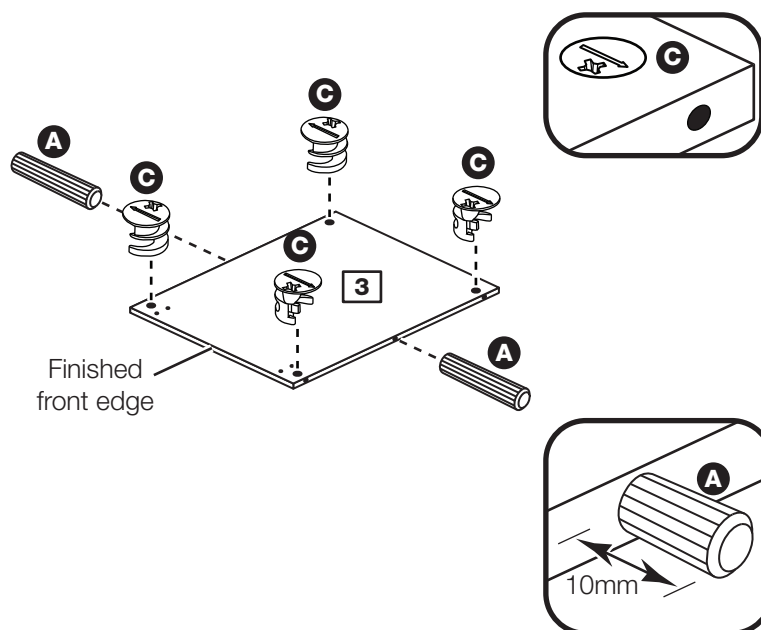

Assembly Instructions

Step 7

Join the fixed shelf to the right side

Push the fixed shelf **3** onto the right side **1**.

Use a screwdriver to tighten the 2 large locking nuts **C** fitted to the fixed shelf **3**.

Note: Turn the large locking nuts **C** as far as they will go - more than 1/2 a turn.

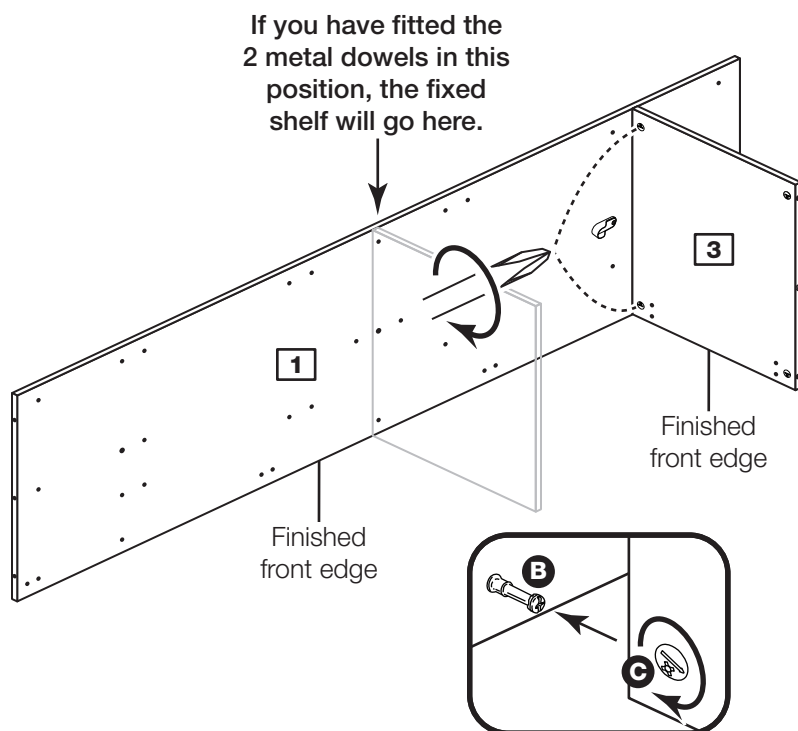

The following diagrams will show the fixed shelf at the top end of the unit. You may have fitted it in the middle of the unit.

Step 8

Fit the left side

Push the left side **1** onto the fixed shelf **3**.

Use a screwdriver to tighten the 2 large locking nuts **C** fitted to the fixed shelf **3**.

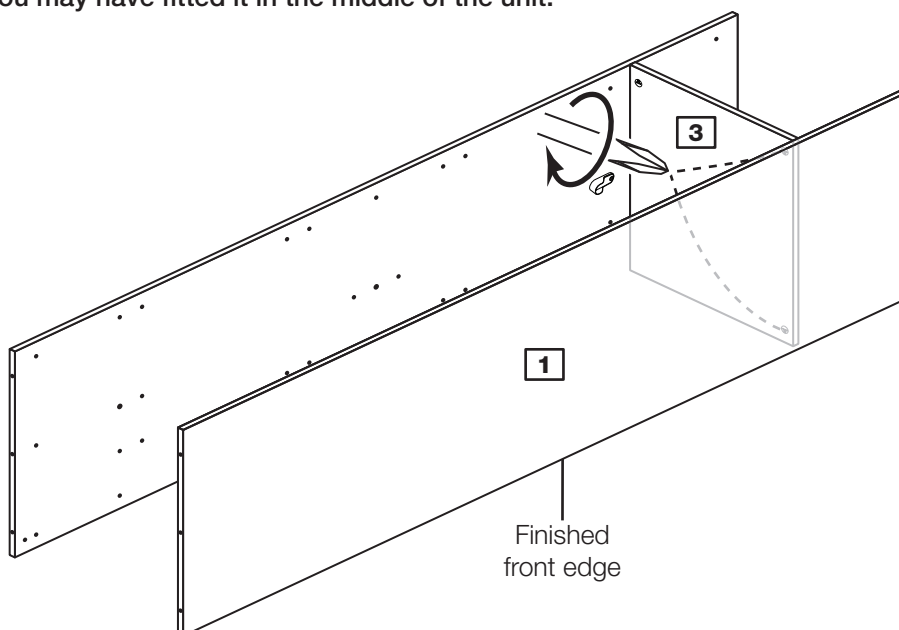

Assembly Instructions

Step 9

Prepare the base

Screw the 4 feet **M** into the shallow mark holes on the base **2** using screws **G**.

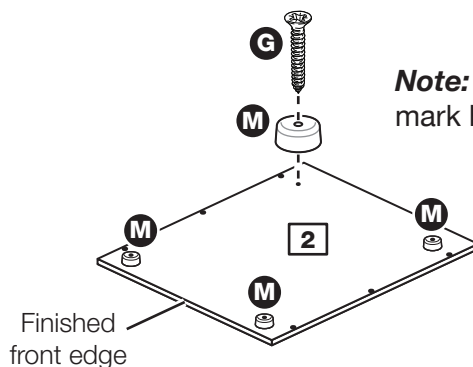

Step 10

Fit the base

Attach the base **2** to the ends **1** using 6 screws **F** and tighten them using the allen key **E**.

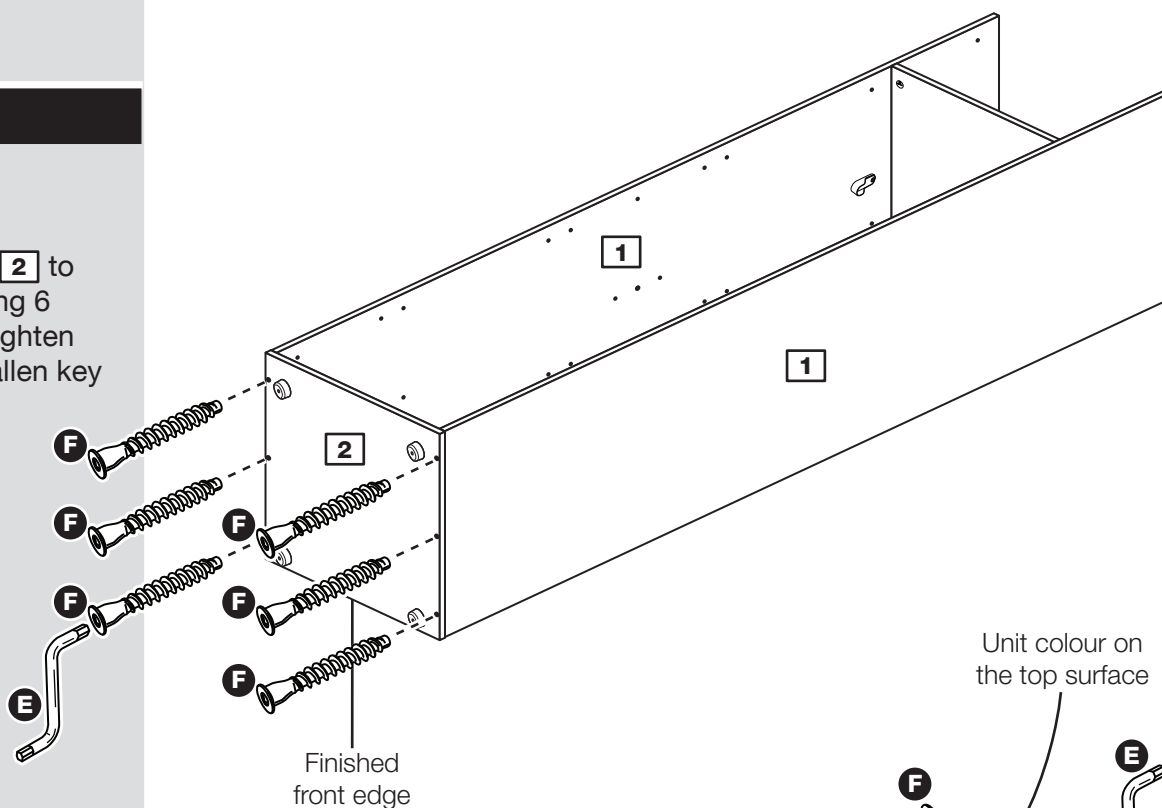

Step 11

Fit the top

Attach the top **2** to the ends **1** using 6 screws **F** and tighten them using the allen key **E**.

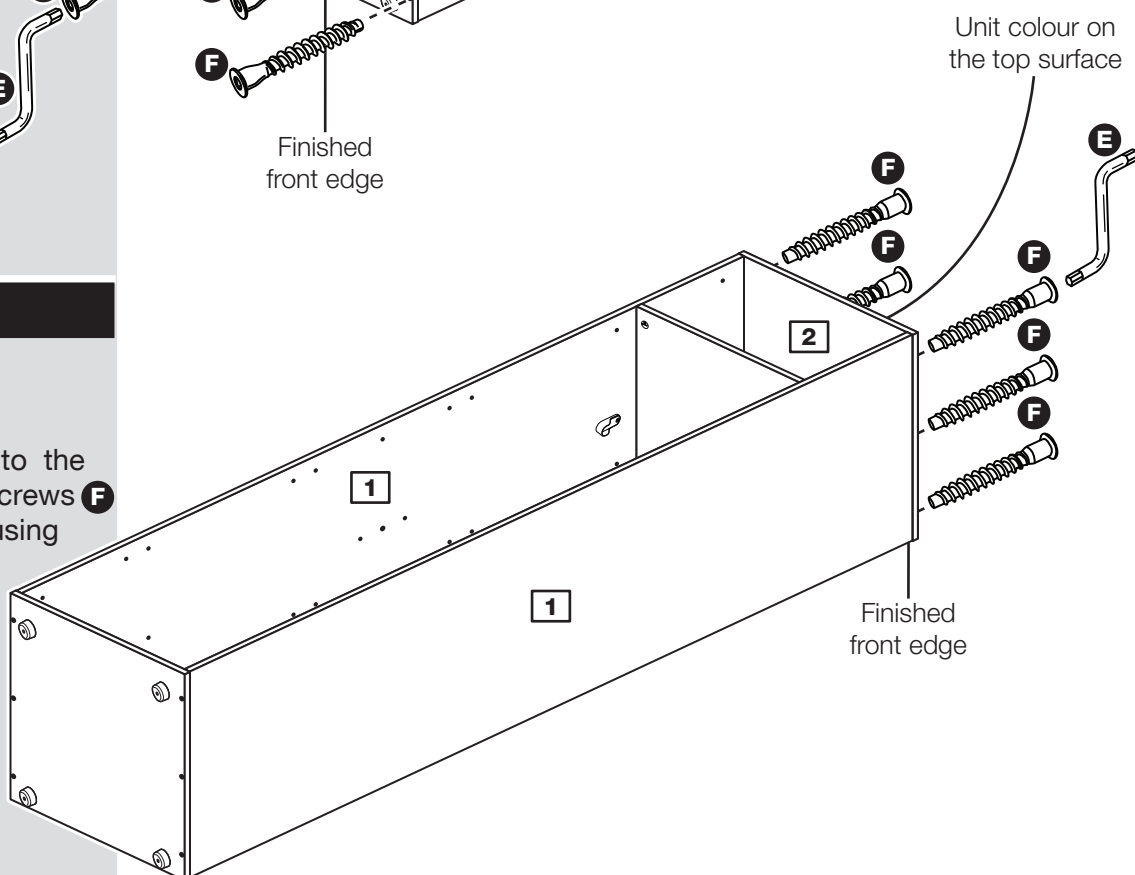

Assembly Instructions

Step 12

Fit the back

a: Square up the unit by making sure that measurement **x** to **x** equals **y** to **y**.

b: Place the back **5** onto the unit.

Nail **D** around the outside edges of the back **5**.

Note: Nails should be spaced about 150mm apart.

Stand the unit up for the next step.



Warning: The unit is heavy. Lift with care.

a: The measurement from top corner X to bottom corner X must be equal to the measurement from top corner Y to bottom corner Y

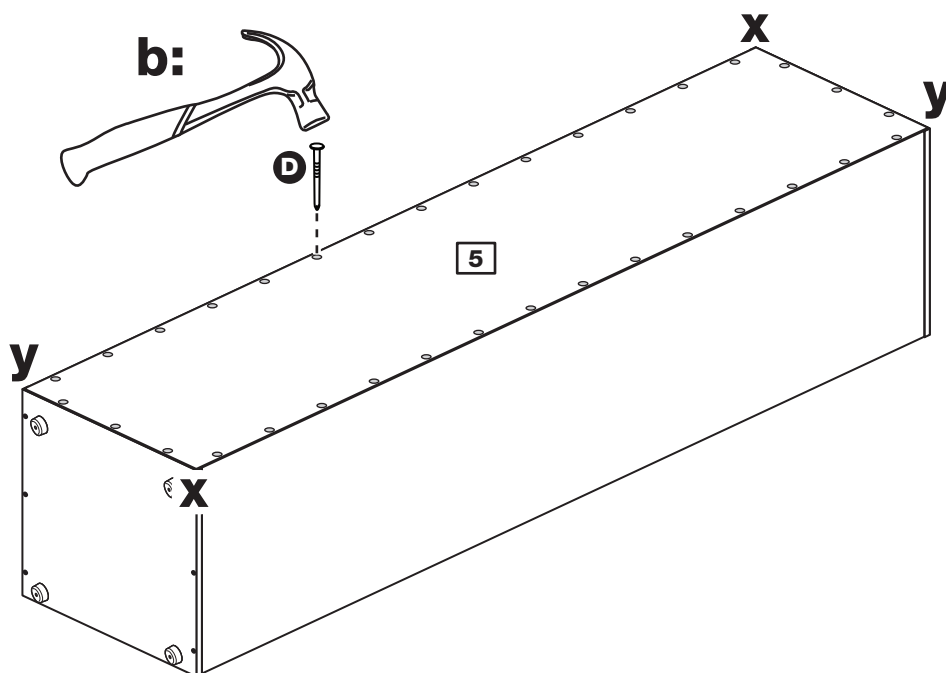

Step 13

Fit the hanging rail(s)

Push the hanging rail(s) **4** into the rail holders **K** fitted to the side panels.

Note: Do not fit the hanging rail(s) if you are fitting the shelf pack.

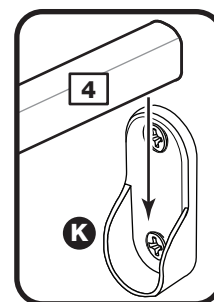
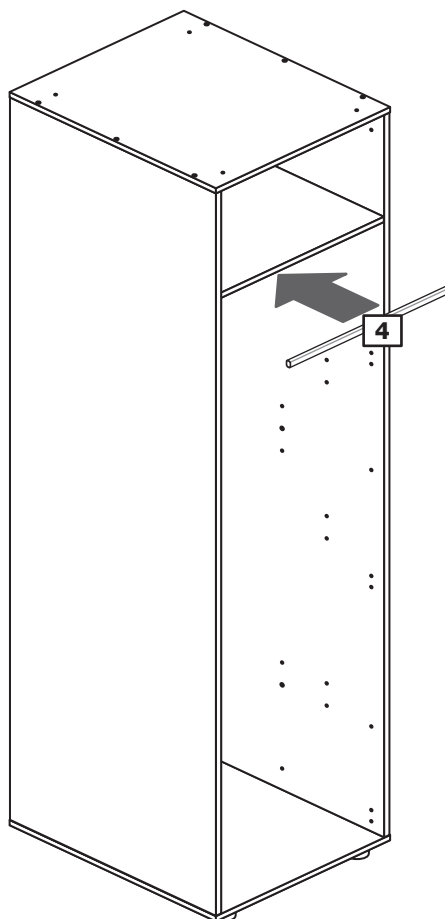

Assembly Instructions

Step 14

Fit the bracket

To prevent possible overbalancing, we recommend that this unit is secured to a suitable wall by use of the bracket **L** fitted to the top of the unit.

Fixings are not supplied, as they will need to suit the wall type and the length of screw will depend on the distance from the back of the unit to the wall.

Fix the bracket **L** loosely onto the top of the unit using screw **I** and mark the wall for the wall fixing.

Swivel the bracket **L** away from the wall and drill a hole in the wall using a suitable drill bit and fit your wall fixing.

Swivel the bracket **L** back and fix the bracket to the wall, then tighten screw **I**.

Note: Take care when drilling the wall that you do not drill into any pipes, wires etc. If in doubt, consult an expert.



Warning: The unit is heavy. Lift with care.

IMPORTANT

The unit **MUST** be fixed to a wall using the bracket supplied. The unit must be level and square before fitting the bracket.

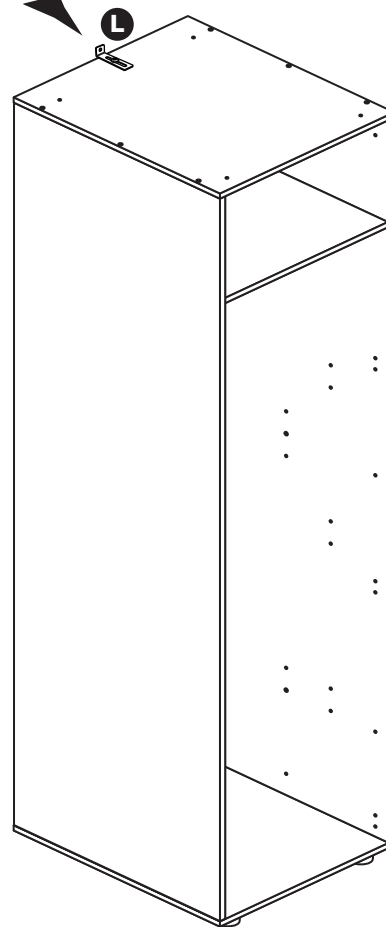
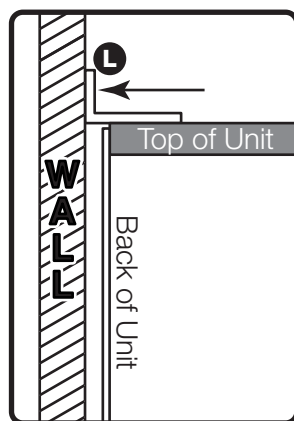
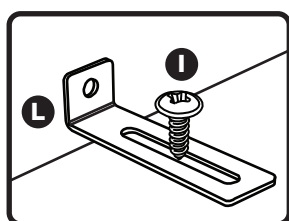

IMPORTANT

The unused fittings from this assembly are used to fit the door. Please refer to the instructions packed with the door.

Assembly Instructions

Step 15

Fit the door and, if required, the shelf pack and internal chest

Please refer to the instructions packed with the door, shelf pack or chest.

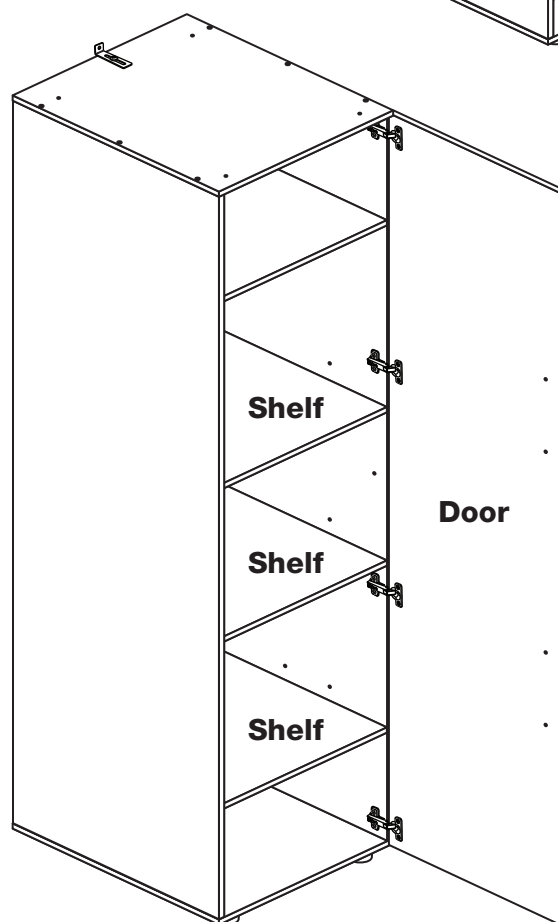
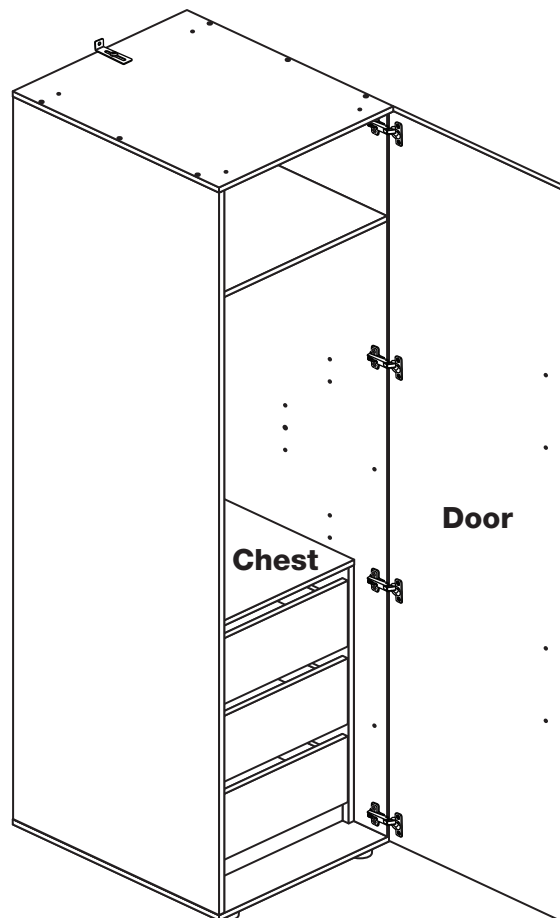

If you need help or have damaged or missing parts, call the **Customer Helpline: 08456 400800** and quote the reference numbers on the component pages.

Argos Ltd, 489-499 Avebury Boulevard, Central Milton Keynes, MK9 2NW

Atlas - Single Mirror Door

Assembly Instructions - Please keep for future reference

157/5709

IMPORTANT

Have you purchased a Single Robe
and an Internal 3 Drawer Chest?
The Chest must be placed into the
Robe **BEFORE** the Door is fitted.

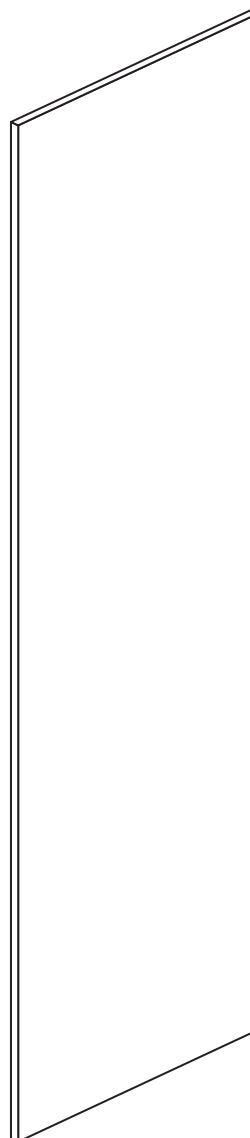

Dimensions

Width - 49.5cm

Depth - 1.5cm

Height - 210cm



**MADE IN
BRITAIN**

Important - Please read these instructions fully before starting assembly

If you need help or have damaged or missing parts, call the **Customer Helpline: 08456 400800**



Safety and Care Advice

Important - Please read these instructions fully before starting assembly

- **Warning:** This panel weighs approximately 22kgs. Please lift with care.
- Check you have all the components and tools listed on pages 2.
- Remove all fittings from the plastic bags and separate them into their groups.
- Keep children and animals away from the work area, small parts could choke if swallowed.
- Parts of the assembly will be easier with 2 people.

- Make sure you have enough space to layout the parts before starting.
- Do not stand or put weight on the product, this could cause damage.
- Assemble the item as close to its final position (in the same room) as possible.
- Assemble on a soft level surface to avoid damaging the unit or your floor (use opened out unit carton).



- We do not recommend the use of power drill/drivers **for inserting screws**, as this could damage the unit. Only use hand screwdrivers.
- **Safety note:** If there is any chance of this unit being pulled over by children etc. it is recommended that the unit is secured to a wall using suitable fixings (not supplied).
- Dispose of all packaging carefully and responsibly.

Care and maintenance

- Only clean using a damp cloth and mild detergent, do not use bleach or abrasive cleaners.
- From time to time check that there are no loose screws on this unit.
- This product should not be discarded with household waste. Take to your local authority waste disposal centre.

Component - Panel

If you have damaged or missing components, call the **Customer Helpline: 08456 400800** quoting the reference numbers below

Please check you have the panel listed below



Mirror Door (D2398MA)
(2100 x 495mm)

Mirror - SG23
2099 x 494mm
Safety Back SAR

Components - Fittings

If you have damaged or missing components, call the **Customer Helpline: 08456 400800** quoting the reference numbers below

These fittings are packed with the Single Mirror Door.



13mm Screw (F52) x 2

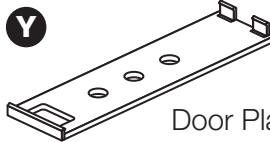

Door Plate (F259) x 1

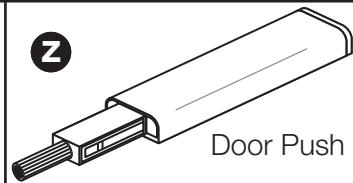

Door Push (F258) x 1

These fittings are packed with the Robe Carcass.
The quantities will depend on which robe you have bought.



13mm Screw (F63)

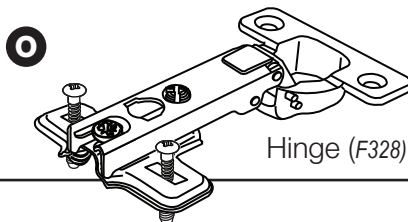

Hinge (F328)



Assembly Instructions

If you have damaged or missing components, call the
Customer Helpline: 08456 400800 quoting the reference
numbers below

Step 1

Do not drill the Mirror Door?

IMPORTANT

DO NOT drill any holes in the Mirror Door.

If you have purchased a Standard Door please use the instructions packed with it.

Step 2

Prepare the door(s)

Lay the door down onto a soft, smooth surface.

Push fit 4 hinges **O** into each door.

Secure each hinge with 2 screws **J**.

Note: Before securing with the screws, make sure that the hinges are positioned at 90 degrees with the edge of the door.



Warning: Glass! Handle with care



Warning: The door is heavy. Lift with care.

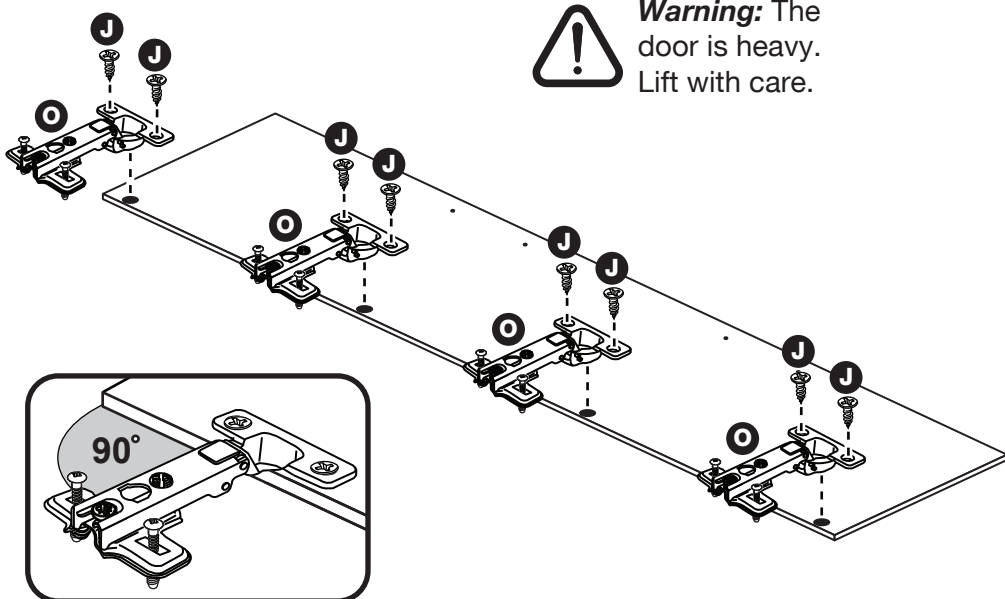

Assembly Instructions

Step 3

Fit the door(s)

2 people are needed here

Line up the 2 screws in the top hinge  with the 2 holes at the top of the panel and push them in.

Working down the door, push in the other hinges.

When all of the hinges have been pushed into place, tighten the 2 screws on each hinge.

Press the screws into the holes in the panels

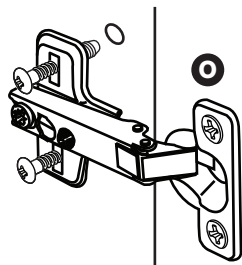

When the hinges have been pushed in, tighten up their screws

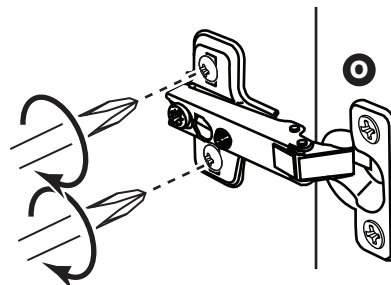

Choose where you would like your mirror door.
This shows a door being fitted onto the right side of a single robe.
The same assembly method applies to all doors and robes.

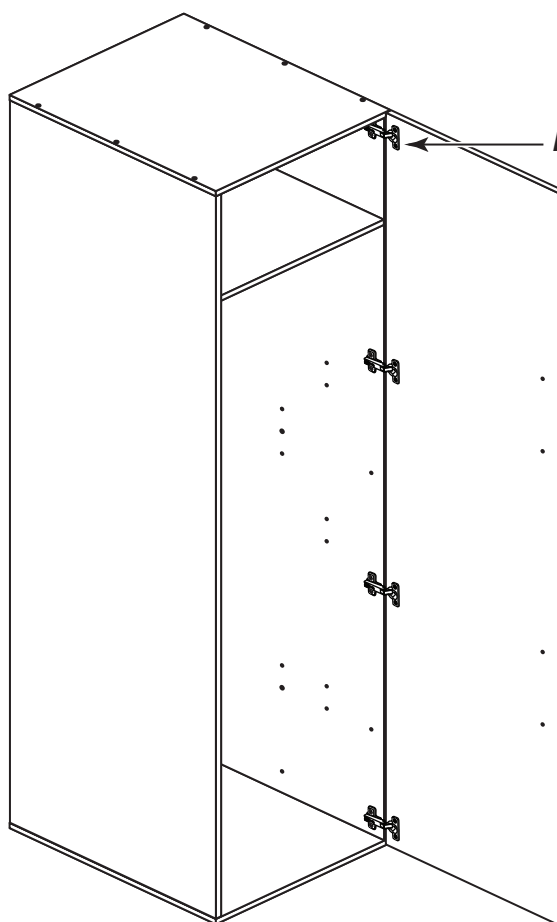

Note: Fit the top hinge 1st



Warning: Glass! Handle with care



Warning: The door is heavy. Lift with care.

Assembly Instructions

Step 4

Adjust the door if needed

a: Before adjusting the door, use a spirit level to check the top (or base) of the unit is level, front-to-back and side-to-side in the 3 positions shown. Use suitable packing pieces (not supplied) to make the unit level BEFORE making any adjustment to the hinges, as shown.

b: Height adjustment.

Loosen screws A on hinge plates and move door up or down as required. Retighten screw A.

c: Forward and Back adjustment.

Loosen screw B on hinge plate and move door in or out as required. Retighten screw B.

d: Sideways adjustment.

To move door 'out' loosen screw C. To move door 'in' tighten screw C.

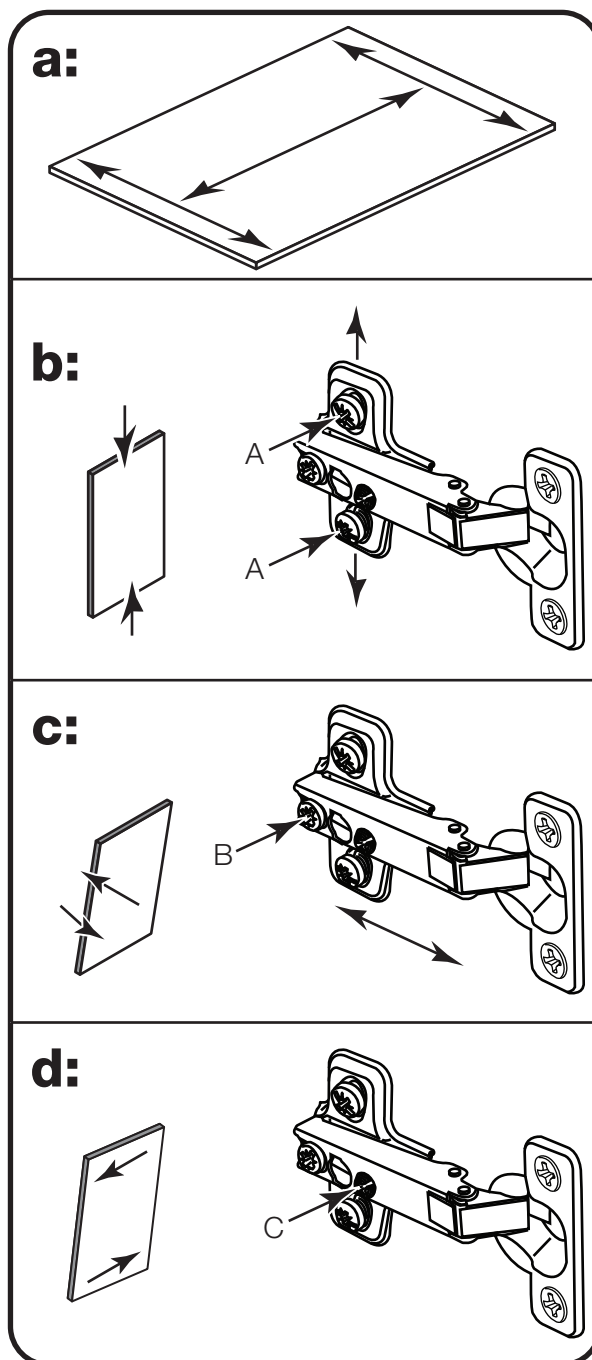

Assembly Instructions

Step 5

Fit the Door Push

a: The arrows show the Door Push fixing positions on each of the Atlas Robes.

These are pairs of holes on the underside of the Fixed Shelves.

Make sure you choose the correct position so that the Mirror Door closes onto the Door Push.

b: Fit a door plate **Y** for each mirror door to the fixed shelf using 2 screws **X**.

Press the door push **Z** into the door plate **Y**.

Press the back of the door push **Z** to click into place.

c: To open and close a mirror door, press it where the door push is located.

You can adjust the door push, in or out, by turning it clockwise or anti-clockwise to suit your requirements.

These diagrams show the fixed shelves at the top end of the units. You may have fitted them in the middle of the unit.

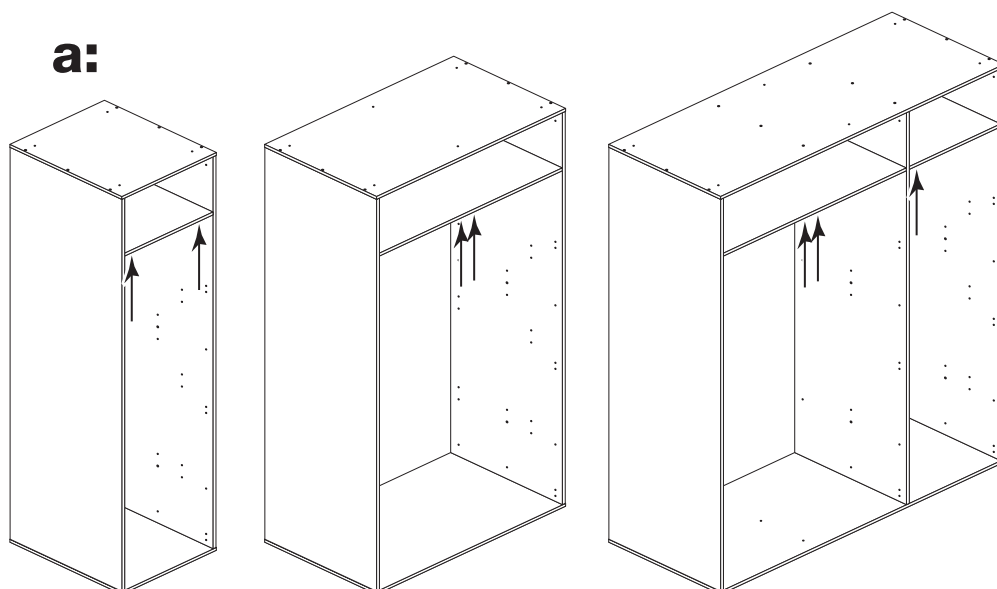

b:

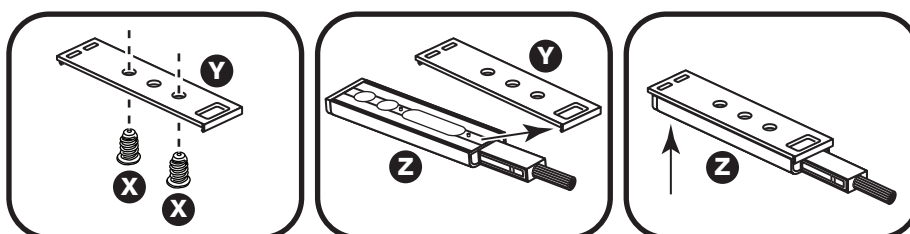

c:

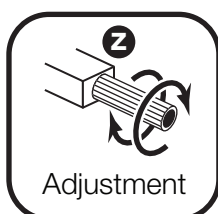

Assembly Instructions

Step 6

Important information

IMPORTANT INFORMATION ABOUT THIS PRODUCT

This product complies with the requirements of BS 7449:1991 and has been manufactured by DECORATIVE PANELS FURNITURE LTD, TEESIDE INDUSTRIAL ESTATE, THORNABY-ON-TEES, CLEVELAND, TS17 9LT.

The product code for this unit and the item code(s) for the glass components are listed in the Assembly Instructions along with a description of the type of glass used. All clear/tinted glass complies with the requirements of BS 6206 Class A. All mirrors comply with the requirements of BS 6206 Class C. If the glass component contained in this unit is chipped or broken consult the furniture manufacturer, retailer, or agent with regard to obtaining a manufacturing specification and shape for replacement glass quoting the unit description and batch number or date of manufacture.

Do not place very hot or very cold items against or in close proximity to glass surface(s) unless adequately thick insulating material is used to prevent such items coming in contact with the glass.

Do not strike the glass with hard or pointed items.

Do not sit or stand upon horizontal glass surfaces.

When cleaning glass panels use a damp cloth or leather with washing up liquid or soft soap if necessary - do not use washing powders or any other substance containing abrasives since these substances scratch glass.

If stated in the instruction leaflet, it is essential that this unit is fixed to a wall.

KEEP THESE INSTRUCTIONS FOR FUTURE USE

If you need help or have damaged or missing parts, call the **Customer Helpline: 08456 400800** and quote the reference numbers on the component pages.

Argos Ltd, 489-499 Avebury Boulevard, Central Milton Keynes, MK9 2NW