

# BUSH RETRO 22" TV/DVD COMBI

Installation & Operating Instructions - Please keep for future reference

143/5540

**BUSH**  
Real Life Technology

**LE-22GRT-A+DVD**

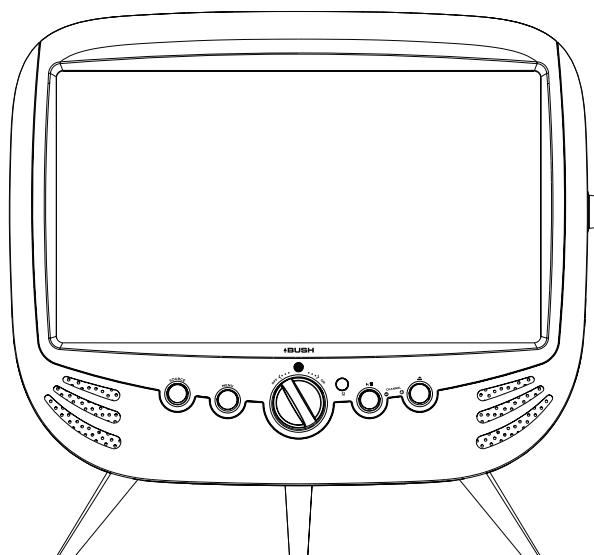

**Important - Please read these instructions fully before installing or operating**

These instructions contain important information which will help you get the best from your television and ensure safe and correct installation and operation.

**For any help concerning set up and use of your TV please call the  
Customer Helpline: 0845 604 0105**

**Lines open: 9am - 8pm Monday to Saturday and 10am - 4pm Sunday**

Issue 1 - 10/10/13



# Contents

## **Safety Information** 2 - 3

## **Getting Started** 4 - 15

Support	4
TV Features	5
Accessories included	5
Base Stand Assembly Instruction	6
Viewing remote control - TV	7-9
TV - Control buttons (Right side)	10
Aerial connection	10
Power connection	10
Remote control - Inserting batteries	11
Switching the TV On and Off	11
Operation using TV control buttons	12
Operation using remote control	12
How to watch a DVD	13
Notes on DVD playback	13
DVD Controls	14
Initial setup	15
General operation	15

## **Connections** 16 - 18

Left side connections explained	16-17
HDMI Connections	18
SCART Connections	18
VGA Connections	18

## **Basic Features** 19 - 34

How to navigate menus	19
Electronic programme guide (EPG) (DTV mode)	19
Teletext (ATV mode)	20
Digital Teletext (DTV mode)	21
Time Shift Function (DTV mode)	21-22
Recording DTV Programme onto a USB Storage Device	22
Timer Programming	23
Play Recorded Programme	24
Picture management	24-25
Sound management	25-26

Channel management (ATV / DTV Mode)	26-29
Lock System management	30
Setup management	30-34

## **Entertainment** 35 - 37

Viewing Photo	35-36
Listening to Music	36
Viewing Movies	36-37
My Text	37
Using the AUX IN Features	37

## **Using the DVD Features** 38 - 44

Using the Built-in DVD Player	38
Compatible Disc Types	38
Basic DVD Playback Functions	39-40
Playing Multimedia Discs	41
Using the DVD Language Setup Page	41-42
Using the DVD Screen Setup Page	42-43
Using the DVD Audio Setup Page	43
Using the DVD Custom Setup Page	43-44
Using the DVD Exit Setup Mode Page	44

## **Other information** 45 - 46

Specifications	45
Digital reception	45
Energy label	46
Trouble shooting	45
Supported file formats	47
Disposal information	49



# Safety Information

**Important - Please read these instructions fully before installing or operating**

	<b>CAUTION</b> RISK OF ELECTRIC SHOCK DO NOT OPEN	
<p><b>CAUTION:</b> TO REDUCE THE RISK OF ELECTRIC SHOCK, DO NOT REMOVE COVER (OR BACK). NO USER-SERVICEABLE PARTS INSIDE. REFER SERVICING TO QUALIFIED SERVICE PERSONNEL.</p>		



The lightning flash with arrowhead symbol, within an equilateral triangle, is intended to alert the user to the presence of uninsulated "dangerous voltage" within the product's enclosure that may be of sufficient magnitude to constitute a risk of electric shock of persons.



The exclamation point within an equilateral triangle is intended to alert the user to the presence of important operating and maintenance (servicing) instructions in the literature accompanying the appliance.

## Power source

- The TV should be operated only from a 100-240V AC, 50 Hz outlet.
- **Warning:** Do not leave your TV in standby or operating mode when you leave your house.

## Positioning the TV

- For ventilation, please leave a clear space of at least 10cm all around the TV.

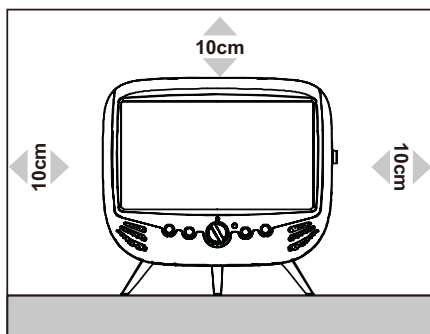

- **Do not** block the ventilation openings.
- Do not place the TV on sloping or unstable surfaces, the TV may tip over.
- To prevent damage to the TV, do not place any objects on top of the TV.
- Only use the TV in moderate climates.

## Power cord and plug

- The power cord plug should be easily accessible. In case of storms and lightning, when going on holiday, or when the TV is not used for a long period of time disconnect the power cord from the mains power socket.
- Mains plug is used as the disconnect device, shall be readily operable.
- **Do not** place the TV, furniture, etc. on the power cord or pinch the cord.
- Handle the power cord by the plug, do not unplug the

TV by pulling the power cord.

- Never touch the power cord/plug with wet hands as this could cause a short circuit or electric shock.
- Never make a knot in the power cord or tie it with other cords.
- Power cords should be placed in such away that they are not likely to be stepped on or driven over.
- A damaged power cord/plug can cause fire or give you an electric shock. When damaged it must be replaced, this should only be done by qualified personnel.

## Moisture and Water

- **Do not** use this TV in a humid or damp place (avoid bathrooms, the sink in the kitchen, and near the washing machine).
- **Do not** expose this TV to rain or water, as this may be dangerous.
- **Do not** place objects filled with liquids, such as flower vases, on top of the TV. Avoid from dripping or splashing.
- If any solid object or liquid falls into the cabinet, unplug the TV and have it checked by qualified personnel before operating it any further.

## Ventilation

- The slots and openings on the TV set are intended for ventilation and to ensure reliable operation.
- To prevent overheating, these openings must not be blocked or covered in anyway.

## Heat sources and Flames

- **Do not** expose the TV to direct sunlight or other heat sources.
- The TV should not be placed near to open flames and sources of intense heat such as an electric heater.
- Ensure that no open flame sources, such as lighted candles, are placed on top of the TV.



# Safety Information

**Important - Please read these instructions fully before installing or operating**

## Headphone volume

- Excessive sound pressure from earphones and headphones can cause hearing loss, please take care.

## Wall mounting (optional)

To prevent injury, this TV must be securely attached to the wall in accordance with the installation instructions (if the option is available).

## LCD Screen

- The LCD screen is a very high technology product with about a million thin film transistors, giving you fine picture details. Occasionally, a few non-active pixels may appear on the screen as a fixed blue, green or red point. Please note that this does not affect the performance of your product.
- Take care not to scratch the screen with fingernails or other hard objects.

## Cleaning

- Before cleaning, unplug the TV from the wall socket.
- **Do not** use liquid or aerosol cleaners. Only use a soft, dry cloth.

## Batteries

- **Warning:** Incorrect installation of batteries may cause battery leakage and corrosion, resulting in damage to the remote control.
- **WARNING:** the battery (battery or batteries or battery pack) shall not be exposed to excessive heat such as sunshine, fire or the like.
- **Do not** mix old and new batteries, or batteries of different types.
- **Do not** dispose of batteries in a fire.
- **Do not** dispose of batteries with normal household waste, take to a local recycling centre.



## Replacement parts

When replacement parts are required, make sure that the service technician has used replacement parts, which are specified by the manufacturer or have the same specifications as the original one. Unauthorised substitutions may result in fire, electrical shock or other hazards.

## Handling discs

- To keep the disc clean, only handle the disc by its edge. **Do not** touch the surface.



- **Do not** stick paper or tape on the disc.
- If the disc is contaminated with any substance like glue, remove before using it.
- **Do not** expose the disc to direct sunlight or heat sources such as hot air ducts, or leave it in a car parked in direct sunlight as the temperature can rise quickly and damage the disc.
- After playing, store the disc in its case.

## Cleaning discs

- Before playing, clean the disc with a cleaning cloth. Wipe the disc from the centre out.

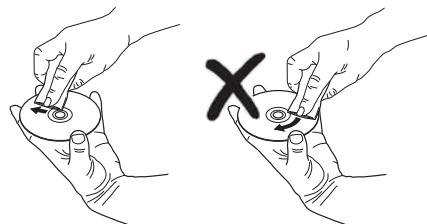

- **Do not** use solvents such as benzene, thinner, commercially available cleaners or anti-static spray intended for vinyl LPs.

## Servicing

- **Warning:** Risk of exposure to radiation from class 1/ class 3b visible and invisible laser beams. **Do not** open the TV and stare directly into beam.
- **Warning:** Risk of electric shock, do not attempt to repair, service or modify this TV yourself. Contact the manufacturer, their approved service agent or the **Customer Helpline: 0845 604 0105**.

- **Warning: To prevent the spread of fire, keep candles or other open flames away from this product at all times.**

# Getting Started

The Argos Technical Helpline is here to help

Technical experts are available 7 days a week

- **Simple help and advice on setting up your digital equipment (image).**
- **Guidance on connecting other devices to your television such as a DVD player, Sky, home cinema system or a games console.**
- **Order spare parts, including that lost remote control.**
- **Any other technical issues you may need assistance with.**

**Call us today: 0845 604 0105**

Local call rates applies\*

**Lines open 9am-8pm Monday to Saturday and 10am-4pm Sunday.**

\*Calls to Argos enquiry lines may attract a charge and set up fee from residential lines depending on your call plan/tariff. Mobile and other providers costs may vary, see [www.bt.com/pricing](http://www.bt.com/pricing) for details.

For Security and training purposes, telephone calls to and from customer service centres maybe recorded and monitored. Calls from Republic of Ireland will attract international call charges.

# Getting Started

## TV - Features

- Remote controlled colour LCD TV.
- Fully integrated digital TV (DVB-T).
- HDMI connectors for digital video and audio. This connection is also designed to accept high definition signals.
- USB input.
- AUX input connect to MP3 or smart-phone to play music
- 100 programmes from VHF, UHF (analogue).
- 400 programmes for digital mode (DTV).
- OSD menu system.
- Scart socket for external devices (such as video' video games, audio set, etc).
- Stereo sound system.
- Teletext, fasttext, TOP text.
- Automatic programming system.
- Forward or backward manual tuning.
- Sleep timer.
- Child lock.
- AVL (Automatic Volume Limiting).
- PLL (Frequency Search).
- PC input.
- Yamaha 2.1CH Digital Amplifier Built-in.

## DVD - Features

- DVD / CD / CD-R / CD-RW / MP3 / JPEG / MPEG playback.
- NTSC / PAL playback (according to disc content).
- LPCM audio via coaxial and optical digital audio outputs (optional).
- Multi-Audio (up to 8) support (according to disc content).
- Multi-Subtitle (up to 32) support (according to disc content).
- Multi-Angle (up to 9) support (according to disc content).
- 8 level parental control.
- Fast forward and rewind - 5 different speeds: 2x, 4x, 8x, 16x, 32x.
- Slow motion playback - 4 different speeds: 1/2x, 1/4x, 1/8x, 1/16x forward.
- Frame by frame forward playback.
- Search Mode.
- Repeat.
- Optical audio output.
- Copied disks may be incompatible.

## Accessories included

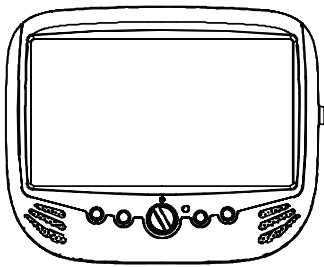

TV



Instruction Book



Remote Control  
Batteries: 2 x AAA



Stand Support



Screws (6PCS)

For any help concerning set up and use of your TV please call the **Customer Helpline: 0845 604 0105**

# Getting Started

## Installing / Removing the Base Stand

### Base Stand Assembly Instruction

1. Place the TV with the display side down on a flat surface. Use a cloth to protect. Locate the bottom at the stand.
2. Line up the stand support to the corresponding position on the stand, then rotate counterclockwise.
3. Fix the stand base with turning the screw (2PCS) tightly on the stand support.

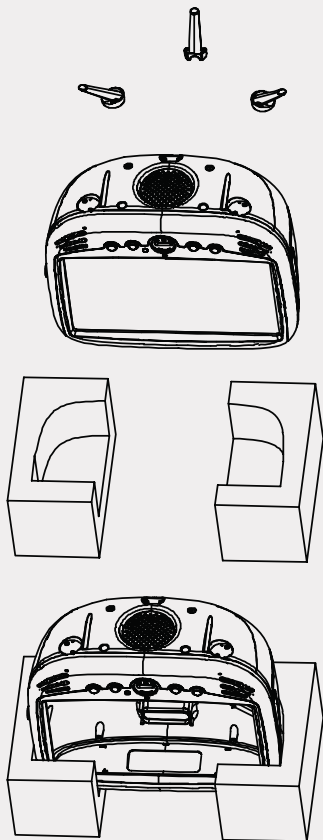

### INSTALLATION NOTES

This TV can be connected to an AC 100-240 Volts, 50/60 Hz power supply. Never connect straight to a DC power supply.

Locate the TV in a room where light does not strike the screen directly. Total darkness or a reflection on the screen can cause eyestrain. Soft and indirect lighting is recommended for comfortable viewing.

Allow enough space between the TV and the wall to permit ventilation.

Avoid excessively warm locations to prevent possible damage to the cabinet or premature component failure.



# Getting Started

## Viewing remote control - TV

### 1.

Switches the TV between on and standby mode.

### 2. **TV.RD**

Select TV program or Radio program. (DTV mode).

### 3. **P.MODE**

Select picture mode: Dynamic / Standard / Mild / Personal.

### 4. **S.MODE**

Select sound mode: Standard / Music / Movie / Personal.

### 5. **ASPECT**

Select from the following mode settings: 16:9 / Zoom1 / Zoom2 / Auto / 4:3.

### 6. **SLEEP**

Set the TV sleep timer.

### 7. **0-9 Number Button**

Press to select a programme. (ATV / DTV mode)

### 8. **CH.LIST**

Display channel list. (ATV / DTV mode)

### **10+**

Press to select a programme, used when the programme number is 10 or greater than 10.

### 9.

Return to the previous viewing channel. (ATV / DTV mode)

### 10. **MUTE**

Mutes and restores your TV sound.

### 11. **CH+/-**

Select a channel.

### 12. **SOURCE**

Select among the different input signal sources: DTV / ATV / AV / SCART / YPbPr / DVD / HDMI / PC / USB.

### 13. **VOL+/-**

Adjust the volume.

### 14. **NICAM**

Switch between different audio channels (only applicable when the TV programme has this feature).

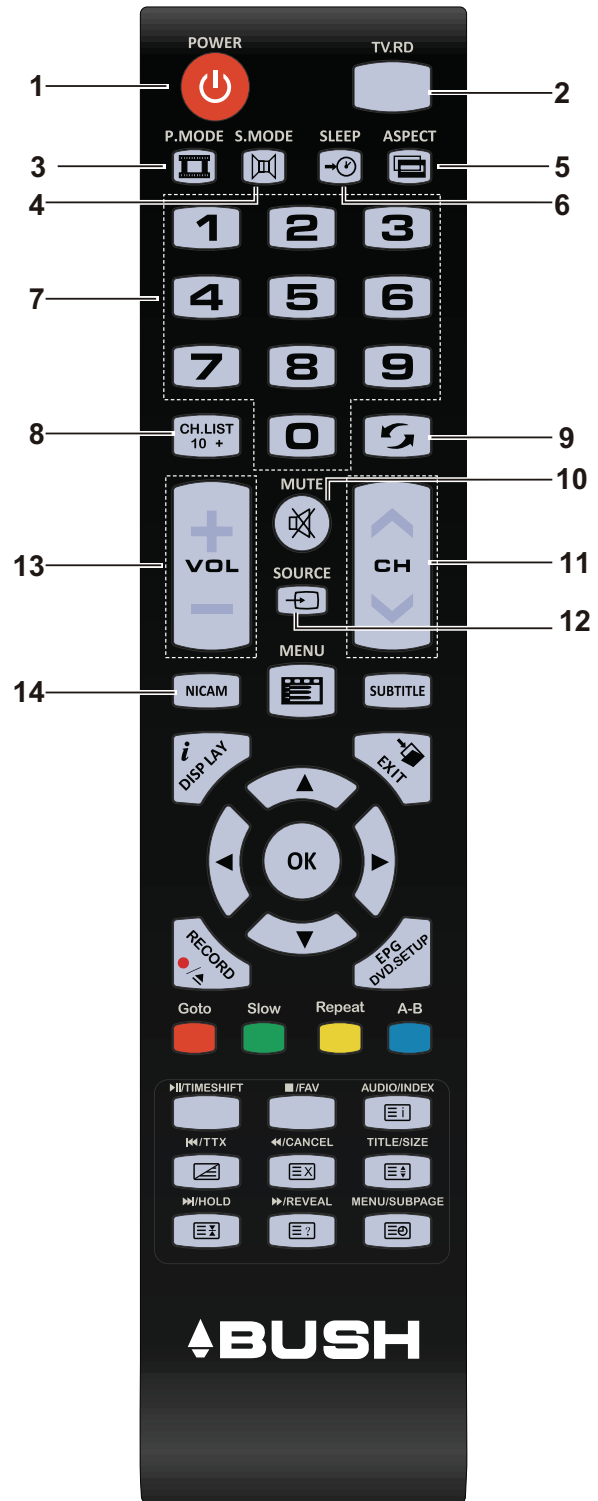

# Getting Started

## Viewing remote control - TV

### 15. SUBTITLE

Display the subtitle which is broadcast with the program. (DTV mode)

### 16. EXIT

Exit the OSD (On Screen Display) menu.

### 17.DISPLAY

Display the present screen information such as the current channel and the input source.

### 18. ◀▶▶▼

Allows you to navigate the OSD menus and adjust the system settings to your preference.

### OK

- Confirm the selection in the OSD menus.
- Display a list of channels saved in the TV tuner memory.

### 19. EPG

Display the EPG (Electronic Program Guide). (DTV mode)

### 20. ●

Record the current programme. (DTV mode)



Ejects a disc. (DVD mode)

### 21. GOTO (RED)

Skips to a specific location on a DVD / CD. (DVD mode)

### 22. SLOW (GREEN)

Plays video slow. (DVD mode)

### 23. A-B (BLUE)

Repeats a segment between A and B. (DVD mode)

### 24. REPEAT (YELLOW)

Selects between different repeat modes. (DVD mode)

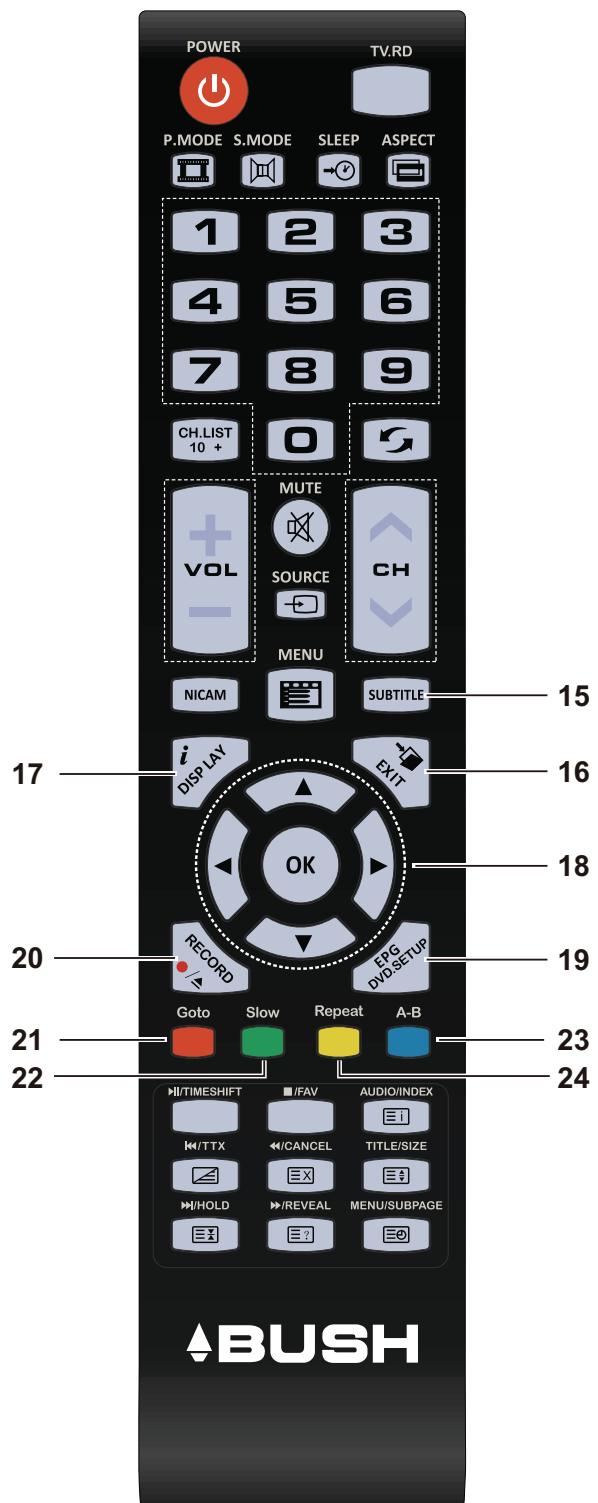

# Getting Started

## Viewing remote control - TV

### 25. INDEX

To select the page number of the index from teletext. (ATV / DTV mode)

#### AUDIO

Press repeatedly to switch among audio options (if available). (DVD mode)

### 26. ■

Press once to stop. (USB / DVD mode)

#### FAV

Display the Favourite Channel list. (ATV / DTV mode)

### 27. SIZE

To enlarge the picture on the TV in teletext. (ATV / DTV mode)

#### TITLE

Display disc menu (if available). (DVD mode)

### 28. TTX

Turn on and off the Teletext function. (ATV / DTV mode)



To skip to the beginning of the previous chapter / track / photo. (USB / DVD mode)

### 29. CANCEL

To exit the teletext mode. (ATV / DTV mode)



To reverse playback rapidly. (USB / DVD mode)

### 30. HOLD

Freezes a multi-page passage on screen in teletext. (ATV / DTV mode)



To skip to the beginning of the next chapter / track / photo. (USB / DVD mode)

### 31. SUBPAGE

Displays the subpage on the teletext screen. (ATV / DTV mode)

#### MENU

Return to the main menu of a loaded DVD (if available). (DVD Mode)

### 32. REVEAL

Reveals hidden information such as the answer to a quiz in teletext. (ATV / DTV mode).



To advance playback rapidly. (USB / DVD mode)



# Getting Started

## TV - Control buttons (front side)

### 1. CHANNEL $\wedge/\vee$

Press to select a channel.

### 2. IR (Infrared Receiver)

Receive IR signals from the remote control.

### 3. POWER Indicator

Illuminate blue when the TV is turned on.

Illuminate red when the TV is in standby mode.

### 4. POWER ON / OFF

Switch the TV between On / Standby mode.

### 5. MENU

Display the OSD (on screen display) menu.

### 6. SOURCE

Press to select among different input signal sources.

### 7. VOL +/-

Turn this knob to adjust the volume.

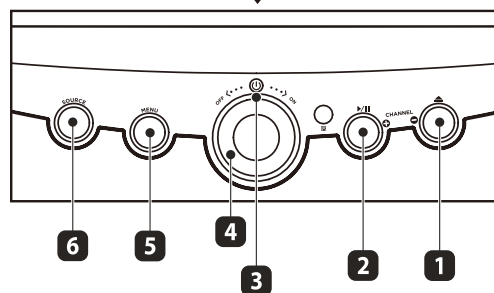
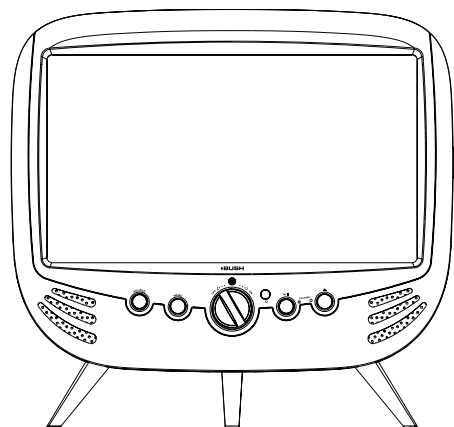

## Aerial connection

Connect the "aerial" or "cable TV" plug to AERIAL INPUT (ANT.) socket located on the back of the TV.

## Power connection

**Please note:** After unpacking, allow the TV to reach ambient room temperature before connecting the TV to the mains power socket.

Connect the power cord plug to the mains power socket.

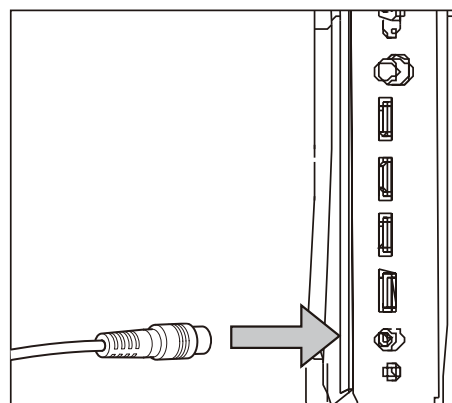

# Getting Started

## Remote control - Inserting batteries

Remove the battery cover on the back of the remote control, gently push down and pull backwards at the same time as shown.

Insert two AAA/R3 or equivalent type batteries. Ensure the batteries are inserted the correct way and replace the battery cover.

**Note:** *When the remote control is not going to be used for long periods of time, the batteries should be removed. Otherwise the remote control may be damaged, caused by battery leakage and corrosion.*

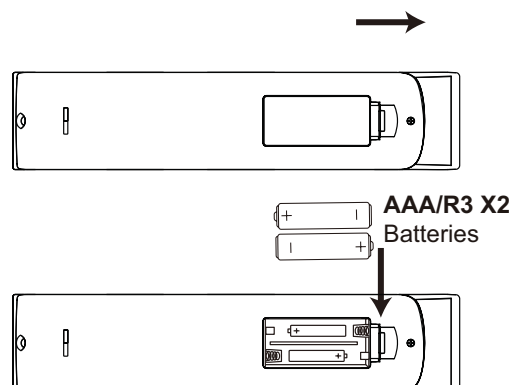

## Switching the TV On and Off

### Switching the TV On

With power cord plug connected to the mains power socket, Turn the "⏻" knob on the main unit, wait the moment, the TV will auto power on.

In 'Standby' Mode, press the "⏻" button on the remote control to switch the TV on.

### Switching the TV Off

press the "⏻" button on the remote control and the TV will then switch to standby mode.

# Getting Started

## Operation using TV control buttons

The **VOL+ / -** knob will function as volume up/down as default. Even if you set other functions for these buttons, the **VOL+ / -**knob buttons will return to volume control after a short while.

### Volume Setting

Turn **VOL+/-** knob to increase or decrease volume.

### Programme Selection

Press **CH+/CH-** buttons to select the next or previous programme.

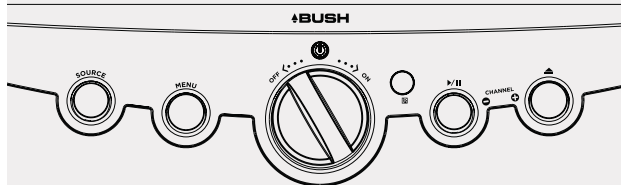

## Operation using remote control

The remote control is designed to control all the functions of the model you selected.

### Volume Setting

Press **VOL+** button to increase the volume. Press **VOL-** button to decrease the volume. A volume level scale (slider) will be displayed on the screen.

### Programme Selection (Previous or Next Programme)

Press **CH-** button to select the previous programme. Press **CH+** button to select the next programme.

### Programme Selection (Direct Access)

Press number buttons on the remote control to select programmes between 0 and 9. The TV will switch to the selected programme.



# Getting Started

## How to watch a DVD

1. Press the “**⏻**” button on the remote control.
2. Switch to DVD source using the “**SOURCE**” button on the remote control.
3. Insert a disc into the loader.  
The content side of the disc **MUST** be facing you when looking at the TV screen.

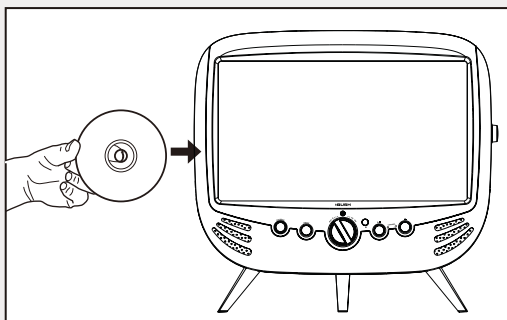

Most discs will be automatically loaded and play will start automatically if the disc does not have any menus recorded on it.

If play does not start automatically, press the “**▶||**” button on the remote control, or the “**▶||**” button on the front right side of the TV.

A menu may appear on the TV screen after a few moments or the film may start immediately after the Film/TV Company introduction. This will depend on the disc content and may differ on each disc.



Steps 4 and 5 are only available when a menu is recorded on the disc.

4. Press the navigation buttons “**◀**”, “**▶**”, “**▲**” or “**▼**” or the number button/s to select the required title.
5. Press the **OK** button. The selected item starts to play.

## Notes on DVD playback

- No sound will be heard during Rapid advance or Rapid reverse.
- No sound will be heard during Slow motion play.
- Reverse Slow motion play is not available.
- In some cases, the subtitle language will not be changed immediately to the selected one.
- When the preferred language will not select, even after pressing the button several times, it means the language is not available on the disc.
- When the DVD player is restarted or the disc is changed, the subtitle selection is automatically changed back to the initial settings.
- If a language is selected that is not supported by the disc, the subtitle language will automatically be set to the disc's priority (default) language.
- Usually a ‘circulation’ will happen while switching to another language, this means you can cancel the subtitle by pressing the same button a number of times until “Subtitle Off” appears on the screen.
- When the power is turned on or the disc is removed, the language heard will be the one selected at the initial settings.
- Some DVDs may not contain root and/or title menus.
- Reverse stepping is not available.
- For reference: If you attempt to enter a number greater than the total time of the current title, the time search box disappears and “Input Invalid **⊗**” message appears on top-left corner of screen.
- The slide show is disabled when the ZOOM mode is on.

# Getting Started

## DVD Controls

You can operate DVD, movie CD, music or picture CD's content by using the correct buttons on your remote control. Below are main functions of commonly used remote control buttons.

Buttons on Remote Control	DVD Playback	Movie Playback	Picture Playback	Music Playback
▶	Play/Pause	Play/Pause	Play/Pause	Play/Pause
■/FAV	Stop	Stop	Return to the picture list	Stop
▲	Open or close the discs tray	Open or close the discs tray	Open or close the discs tray	Open or close the discs tray
DVD.SETUP	Displays the DVD OSD menu	Displays the DVD OSD menu	Displays the DVD OSD menu	Displays the DVD OSD menu
⏮/TTX	Skip backward	Skip backward	Skip backward	Skip backward
⏪/CANCEL	Rapid reverse	Rapid reverse	X	Rapid reverse
TITLE/SIZE	Display disc menu (if available)	Display disc menu (if available)	X	X
SUBTITLE	Subtitle on-off. Press repeatedly to switch between subtitle option	Subtitle on-off. Press repeatedly to switch between subtitle option	X	X
⏭/HOLD	Skip forward	Skip forward	Skip forward	Skip forward
⏭/REVEAL	Rapid advance	Rapid advance	X	Rapid advance
MENU/SUBPAGE	Return to the main menu of a loaded DVD (if available)	Return to the main menu of a loaded DVD (if available)	Return to the main menu of a loaded DVD (if available)	X
AUDIO/INDEX	Press repeatedly to switch among audio options (if available)	Press repeatedly to switch among audio options (if available)	X	Press repeatedly to switch among audio options (if available)
GOTO	Go to a specified track or time on a loaded disc	Go to a specified track or time on a loaded disc	X	X
SLOW	Slow down playback speed	Slow down playback speed	X	X
REPEAT	Displays repeat options	Displays repeat options	Displays repeat options	Displays repeat options
A-B	Repeat a selected section	Repeat a selected section	X	Repeat a selected section



# Getting Started

## Initial setup

1. Connect one end of the RF coaxial cable to the aerial socket on the wall and the other end of the cable to the RF (75Ω) socket at the rear left side of your TV.
2. Connect the mains cable to the mains socket after you have completed all the connections.
3. In standby mode, press the **⏻** button on the remote control to turn the TV on. The red LED indicator will turn blue.
4. The first time you turn the TV on, it will go straight into **First Time Setup** menu. Press the **◀▶▲▼** buttons to navigate the menu and change the settings.

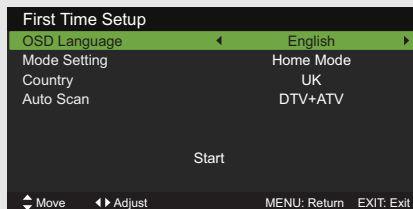

### OSD Language

Selects your desired language to be displayed on the menu. The default on-screen menu language is set as English.

### Mode Setting

Selects your desired mode setting.

- Home Mode: Viewing at home.
- Store Mode: For store demo, the brightness is higher than home mode.

### Country

Selects the country where you will operate the TV. The default country is set as UK.

### Auto Scan

Selects the auto scan type: DTV+ATV / DTV / ATV.

### Start

Press the **OK** button to start auto tuning. Auto Scan will commence. The display will show the progress of the tuning and the number of channels found.

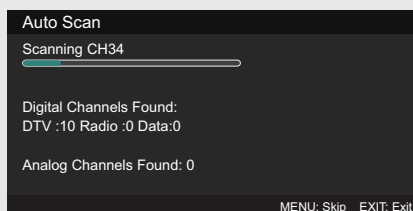

## Initial setup

5. If you want to skip the DTV tuning, press the **MENU** button to interrupt the tuning half way. You will then go straight to ATV tuning. You may repeat the above step if you also want to skip the ATV tuning.

## General operation

Press the **SOURCE** button on the remote control and select DTV to switch the TV to Digital Terrestrial Television Broadcasting.

### Information Banner

Whenever you change channel using the **CH+ / CH-** buttons or the number buttons, the TV displays the broadcast picture along with an information banner on the top left of the screen (available only in DTV/ATV mode).

The information banner can be displayed at any time while watching TV by pressing the **DISPLAY** button on the remote control.

# Connections

## Left side connections explained

### 1. CI Slot

Used to insert a CI card. A CI card allows you to view all the channels that you subscribe to. For more information, see "Conditional Access" section.

### 2.AUX IN

Connect to MP3 or smart-phone to play music.

### 3.OPTICAL

Connect a digital sound system to this jack.

### 4. USB Input

To connect devices to the TV, providing fast data exchange. USB will have function in Media/DTV mode.

### 5. HDMI Input

Connects a device that has an HDMI socket. The TV can display High Definition pictures from devices such as a High Definition Satellite Receiver or DVD Player. These devices must be connected via the HDMI sockets or Component Socket. No sound connection is needed for an HDMI to HDMI connection.

### 6. PC Input (VGA) / PC AUDIO

Connects a personal computer to the TV. Connect the PC cable between the PC INPUT on the TV and the PC output on the PC.

**Note:** If you connect a device to the TV via the PC cable, you should also use an audio cable to connect your device to the PC AUDIO INPUT to enable audio.

### 7. SCART socket

Inputs or outputs for external devices. Connect the SCART cable between the SCART socket on the TV and the SCART socket on the external device (decoder, VCR or DVD player).

**Note:** If an external device is connected via the SCART socket, the TV will automatically switch to SCART mode.

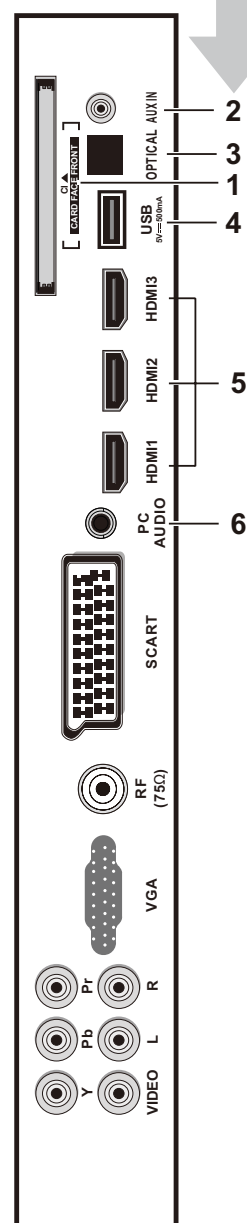
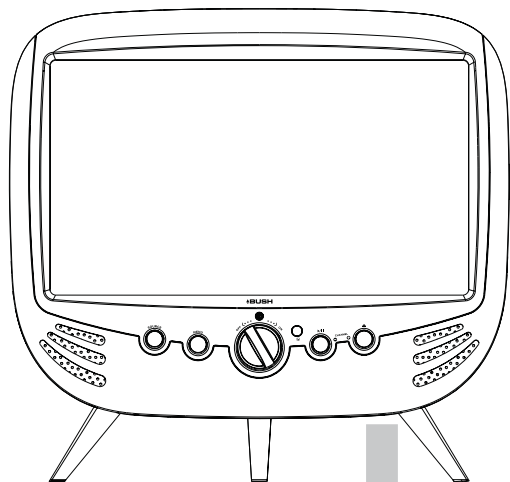

# Connections

## Left bottom connections explained

### 7. SCART socket

Inputs or outputs for external devices. Connect the SCART cable between the SCART socket on the TV and the SCART socket on the external device (decoder, VCR or DVD player).

**Note:** If an external device is connected via the SCART socket, the TV will automatically switch to SCART mode.

### 8.RF Input (ANT.)

Connects to aerial (antenna) or cable TV. If you use a decoder or a media recorder, you should connect the aerial cable through the device to the TV with an appropriate aerial cable.

### 9.VGA Input

Connect to a computer or other devices with a VGA interface.

### 10. Video Input

To connect video signals of external devices. Connect the video cable between the VIDEO IN socket on the TV and the VIDEO OUT jack on your device.

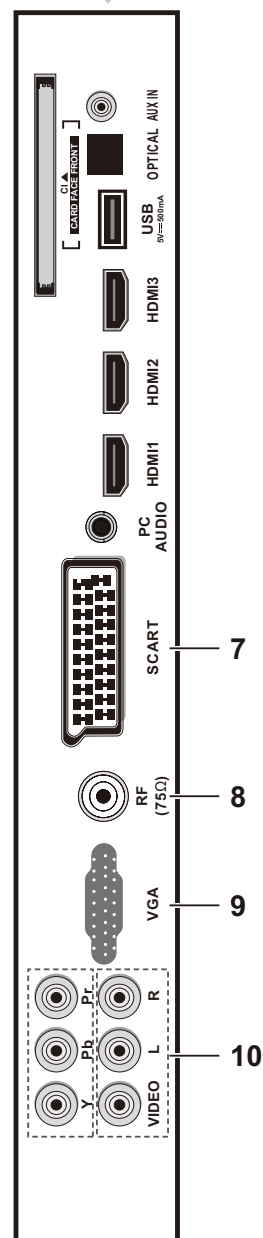
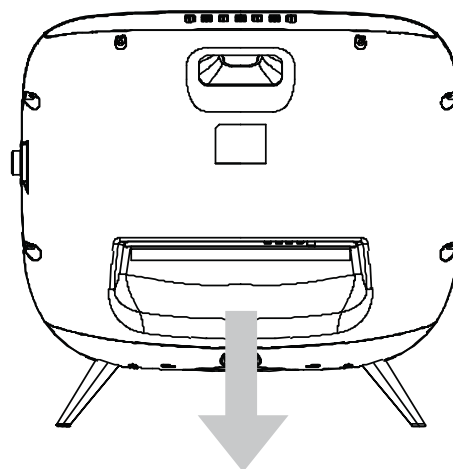

# Connections

## HDMI Connections

HDMI lets you enjoy high definition digital images and high quality sound by connecting the TV to external devices such as DVD players, set top boxes or gaming equipment.

Power off both the TV and the device before making any connections.

For more information, refer to your device's own instruction book.

When connecting, switch "Source" to "HDMI". See, "Input Selection" section.

**Note:** HDMI cable is not supplied.

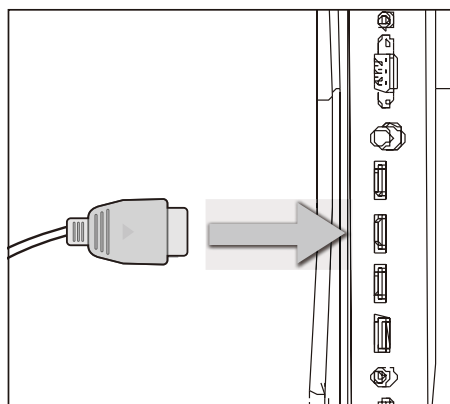

## SCART Connections

Most devices support SCART connection. You can connect a DVD recorder, VCR or decoder to the TV using the SCART socket.

Power off both the TV and the device before making any connections.

For more information, refer to your device's own instruction book.

**Note:** The Scart cable is not supplied.

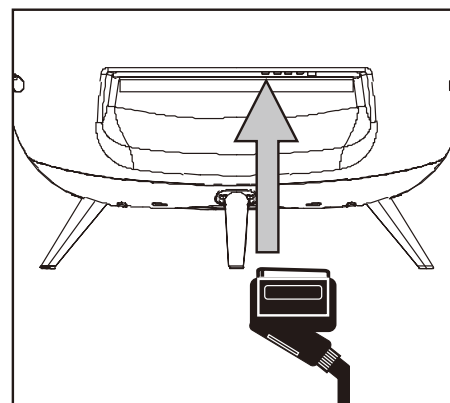

## VGA Connections

You can connect a computer (PC) to the TV to display your computer's screen image on the TV.

Power off both computer and TV **before** making any connections.

Use a 15-pin D-sub display cable to connect a PC to the TV. Use an audio cable between PC AUDIO inputs on the left side of the TV and audio output on your PC to enable sound connection.

When the connection is made, switch "Source" to "PC". See "Input selection" section.

Set the resolution that suits your viewing requirements. Resolution information can be found in the "Appendix parts".

**Note:** The VGA cable is not supplied.

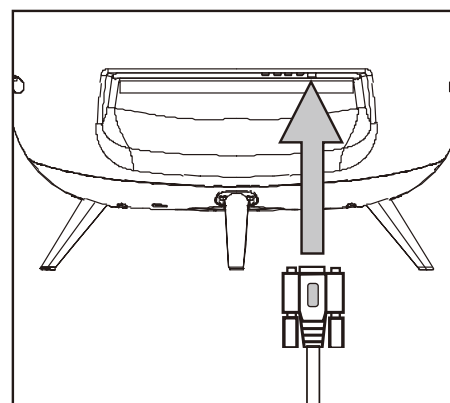

# Basic Features

## How to navigate menus - Selecting source

1. Press the **SOURCE** button on the front of the TV or the **SOURCE** button on the remote control to display the Input source list.
2. Press the **▲▼** buttons to select the input source that you want: DTV / ATV / SCART / AV / YPbPr / DVD / HDMI1 / HDMI2 / HDMI3/ PC / USB / AUX
3. Press **OK** button to confirm your selection.

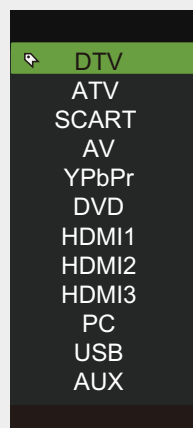

## Electronic programme guide (EPG) (DTV mode)

This system has an Electronic Programme Guide (EPG) to help you navigate through all the possible viewing options.

The EPG supplies information such as programme listings, start and end times for all available services. In addition, detailed information about the programme is often available in the EPG (the availability and amount of programme information will vary, depending on the particular broadcaster).

This function can be used only when the EPG information is broadcast by broadcasting companies.

The EPG displays the programme details for the next 7 days.

1. Press the **EPG** button to switch on EPG.



2. Press **EPG** button or **EXIT** button again to switch off EPG and return to normal TV viewing.

*Info bar commands:*

**RED** (Prev. Date)

Press the **RED** button to view the schedule of the previous day.

**GREEN** (Next Date)

Press the **GREEN** button to view the schedule of the next day.

**YELLOW** (Schedule)

Press the **YELLOW** button to view the preset reminders in the schedule list. Press the **YELLOW** button to return to the EPG.

**BLUE** (Reminder)

Press the **BLUE** button while on the selected programme, the Reminder setting menu will be displayed.

Press the **▲▼◀▶** buttons to adjust the settings and then press the Save button to confirm the settings. After confirmation, the EPG Schedule List will then be displayed with your preset reminders shown. Press the **YELLOW** button to return to the EPG. The TV will automatically tune to the selected programme when it starts.

**REC**

Timer Programming.

**OK**

Press to display detailed information of the selected programme (if available).

# Basic Features

## Teletext (ATV mode)

Teletext is a free service broadcast by some TV stations which gives up-to-the-minute information on news, weather, television programmes, share prices and many other topics. Using the Teletext control buttons you can view pages of information that are listed in the teletext index.

### To Turn on Teletext Function



Make sure the TV channel you are watching transmits teletext.  
"No Teletext" sign will show on the screen if teletext is not available.

In ATV mode, press the **TTX** button to enter Teletext mode. Press the **INDEX** button to display the index page.

Press the **TTX** button once to exit and the TV will return to the channel you were watching.

### To select a page of text

Find the number of the page in the index and enter it using the **0-9** buttons. The number of the page will appear on the top left corner of the screen.

The page counter will search for your page. When it finds it, the page will be displayed.

To move to the next page of text, press the button.

To move to the previous page, press the button.

To return to the index page, enter the "100" by using the **0-9** buttons or press the **INDEX** button.

### Mix

To view a page of text while watching a TV programme, press the **TTX** button twice. The text will be superimposed over the TV programme.

### Double height text

If you have difficulty reading the text on the TV you can double the height of the text.

Press the **SIZE** button. The top half of the page will be displayed in double height text.

Press the **SIZE** button again. The bottom half of the page will be displayed in double height text.

Press the **SIZE** button again to return to the full page.

### Page HOLD

If the page of text you have selected contains subpages, these subpages will automatically be displayed in order with a delay to allow you to have enough time to read the page.

To stop the movie to the next sub page, press the **HOLD** button.

To continue moving through the sub pages, press the **HOLD** button again.

*Alternative: Press the **SUBPAGE** button, and then use the 0-9 buttons to enter a 4-digit page number.*

### To Reveal Information

Press the **REVEAL** button to reveal concealed information (quiz answers etc.).

Press the **REVEAL** button again to conceal the information again.

### Fasttext

At the bottom of the teletext screen is a row of subject headings in red, green, yellow and blue.

The remote control has a row of colour buttons corresponding to the row of coloured subjects on the screen.

Pressing one of the colour buttons will take you directly to the page corresponding to the subject heading.

# Basic Features

## Digital Teletext (DTV mode)

Digital teletext can access special digital teletext services and specific services which broadcast digital teletext. You will need to turn off Subtitle Function before using teletext.

1. In DTV mode, press the  **TTX** button to display the teletext page.



2. Press the **0-9** buttons to select a page number.
3. Follow the instructions on digital teletext and move onto the next step by pressing **OK**, **▲▼**, **◀▶**, **RED**, **GREEN**, **YELLOW**, **BLUE** or **0-9** buttons etc.
4. To change digital teletext service, select a different service by pressing the **0-9** buttons or the **▲▼** buttons.

*Alternative: You may press the **RED** button to the  **TTX** button to display the teletext information when you see a ● red logo displayed on the screen (e.g. BBC).*

5. Press the  **TTX** button to exit.

## Time Shift Function (DTV mode)

This function allows the TV to virtually record the live viewing broadcast programme.

**Note:** If the transfer rate of the USB storage device is too slow for recording or time shift function, a warning statement will be shown on the screen. If this happens, please upgrade your USB storage device.



- Time Shift Mode and Recording functions may not work if the signal strength is weak.
- Stop the time-shift function before switching to another input source.

During normal TV viewing, you may press the **TIMESHIFT** button to virtually pause the live viewing broadcast programme if you want to go out for a while (e.g. going to the bathroom / kitchen). “**||**” will show on the screen.

When you have returned, press the **▶||** button to display the PVR Time Shift progress bar and then press the **◀▶** buttons to select “**▶**” on the bar. Press the **OK** button to play the missed broadcast programme. “**▶**” will show on the screen.

The video and sound may have a little bit of delay or be out-of-sync for a few seconds when the unit starts to playback the missed broadcast

programme. It will soon turn to normal.



### The ‘PVR Time Shift Progress Bar’

- 1 Indicates the status of the currently displayed video ( **▶** / **||** / **◀** / **▶** )
- 2 Indicates the time lagging behind the live broadcast (PVR reviewing)
- 3 Indicates the available recording time on your USB storage device



# Basic Features

## Time Shift Function (DTV mode)

### Using the Remote Control

You can shift playback to any point of the virtually recorded programme. Press the **TIMESHIFT** button to display the PVR Time Shift progress bar again.

#### TIMESHIFT

During playback, press the **TIMESHIFT** button to display a still screen.

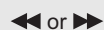

When playing,

- Press the **⏩** button repeatedly to speed up  $\lll \times 2 / \times 4 / \times 8 / \times 16$ .
- Press the **⏪** button repeatedly to speed up  $\ggg \times 2 / \times 4 / \times 8 / \times 16$ .
- During fast forward / fast backward state, press the **⏮** button to return to normal playback.

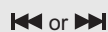

- Press the **⏩** button to jump about 10% forward.
- Press the **⏪** button to jump about 10% back.



- During playback, press the **⏮** button to display a still screen and then press the **⏮** button again to resume playback.

- During fast forward / fast backward state, press the **⏮** button to return to normal playback.



If you want to exit the PVR Time Shift progress bar and return to the current live broadcast, press the **OK / ■** button and then press the **⏪** button to confirm.

## Recording DTV Programme onto a USB Storage Device

Use this function to record the DTV programme you are watching on the main screen and save it for future viewing. The recording from timer programme or direct recording may have a little bit of delay when it starts to record the broadcast programme.

Please make sure the USB device is inserted. If not, a warning message will pop up.

1. Press the **● REC** button to record the programme that you are currently watching.



To display the recording information, press the **● REC** button.

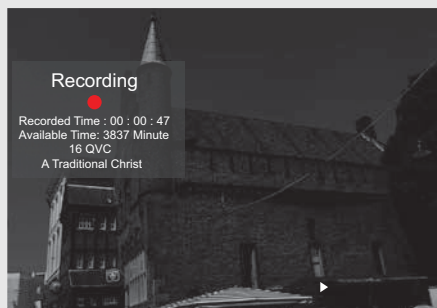

2. Press the **■ Stop** button to stop recording.



Recording will stop automatically when the disk is full.



- If a hard disk is used, make sure its mains adapter is connected to the mains supply.
- If a USB hub is used, make sure its mains adapter is connected to the mains supply as the total current consumption may exceed 500mA.
- The maximum supported storage space of the hard disk is 1 TB.
- The file system only supports FAT32 format.
- If you want to store the video streaming of a DTV programme, the transfer rate of the USB storage device must not be less than 5MB/s, otherwise the picture and sound of the programme will be affected and a warning statement will be shown on the screen. If this happens, please upgrade your USB storage device.
- The TV screen will be blank temporarily as it will take time to start up and stabilise the connected hard disk. This is normal and the starting time may vary depending on the brand and the memory size of the connected hard disk.
- Disconnect the USB storage device if it is not in use.



# Basic Features

## Timer Programming

This function is used for scheduled recording.

The recording from timer programme or direct recording may have a little bit of delay when it starts to record the broadcast programme.

Please make sure the USB device is inserted. If not, a warning message will pop up.

1. Press the **EPG** button on the remote control. The **EPG** menu will appear.



2. Press the **● (REC)** button on the remote control while on the selected programme, the **Scheduled Record** menu will be displayed. Press the **▲▼◀▶** buttons to select the settings in the **RECORD** menu for the Frequency, Channel, Start time, and End time.

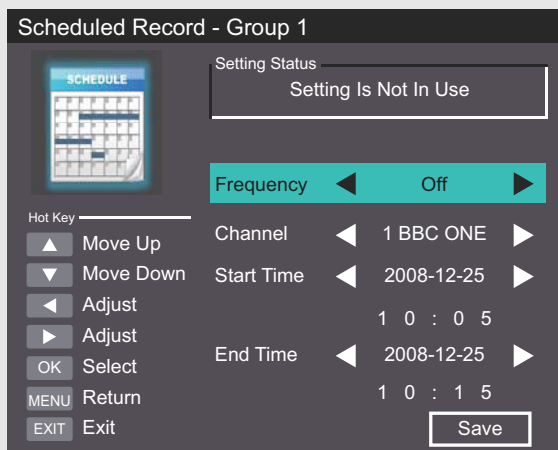

### Frequency

Press the **◀▶** buttons to select the frequency (Off/Once / Daily / Weekly / Weekday).

### Channel

Press the **OK** button and then press the **▲▼** buttons to select the channel that you want to record.

**Start time** (for Mode Once, Daily, Weekly, Weekday) Press the **▲▼◀▶** buttons to adjust the start time.

**End time** (for Mode Once, Daily, Weekly, Weekday) Press the **▲▼◀▶** buttons to adjust the end time.

3. After finishing all the recorder adjustments, press the Save button to confirm your settings.

4. The **Scheduled Record Setting List** will then be displayed with your preset reminders shown.

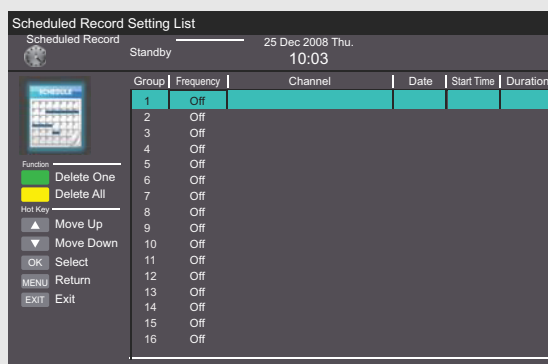

5. Press the **EXIT** button to exit EPG.



- When the preset time is reached, the TV will start recording automatically.
- If a programme recording starts when the TV is in standby mode, the LED indicator will alternatively flash red and blue.

# Basic Features

## Play Recorded Programme

You can play a recorded programme from the recorded programme list or from a USB Storage Device.

1. Press the **SOURCE** button on the front of the TV or the **SOURCE** button on the remote control then press the **▲▼** buttons to select the **USB** mode and then press the **OK** button.
2. Press the **◀▶** buttons to select **MOVIE** and then press the **OK** button.

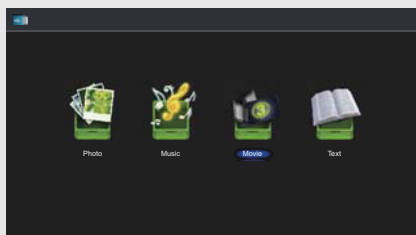

3. Press the **▲▼** buttons to select your storage device and then press the **OK** button.

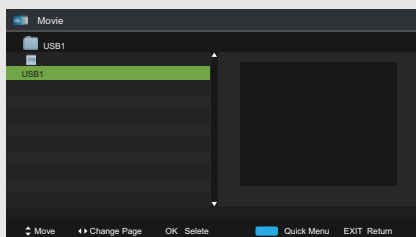

4. Press the **▲▼** buttons to select the “**usbrecord**” folder and then press the **OK** button.

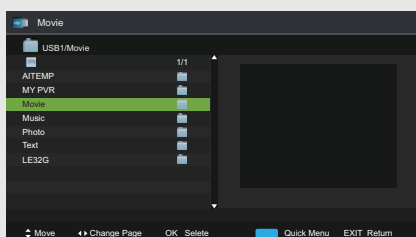

5. Press the **▲▼** buttons to select your recorded programme and then press the **▶||** button to view.

## Play Recorded Programme

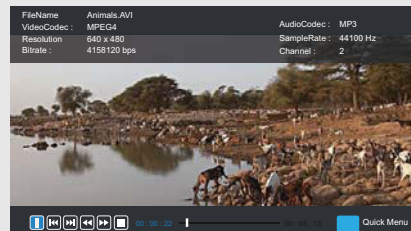

6. Press the **OK** button or the **DISPLAY** button to display the function bar. Press the **◀▶** buttons and then press the **OK** button to select the function: Pause / Next / Prev. / FB / FF / Stop / Quick Menu (Repeat / Encode Type).
7. Press the **EXIT** button to return to the previous menu.

## Picture management (ATV / DTV Mode)

1. Press the **MENU** button to display the main menu. Press the **◀▶** buttons to select **Picture** in the main menu, then press the **▼** or **OK** button, it will highlight the first option.
2. Press the **▲▼** buttons to select the option you want to adjust in Picture menu.
3. Press the **◀▶▲▼** buttons to change the following settings.

### TIPS:

- You can change the value of brightness, contrast, sharpness and saturation when the picture is in Personal mode.
- You can press **P.MODE** button on the remote control to change the Picture Mode directly.

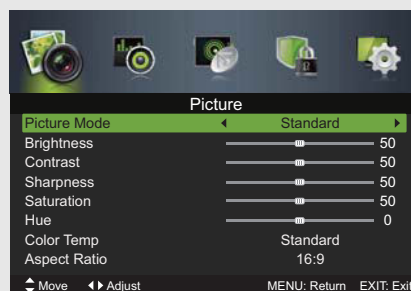

# Basic Features

## Picture management

### Picture Mode

Allows the selection of a picture-enhancement technical from among the following options: Dynamic / Standard / Mild / Personal.

### Brightness

This item can adjust the optical fiber output of the entire picture; it will affect the dark region of the picture.

### Contrast

This item can adjust the highlight intensity of the picture, but the shadow of the picture is invariable.

### Sharpness

This item can adjust the peaking in the detail of the picture.

### Saturation

This item can adjust the saturation of the color based on your own like.

### Hue

This item may use in compensating color changed with the transmission in the NTSC code.

### Color Temp

This item can increase or reduce warm color of the picture personally (red), and the cold color (blue) according to your like. The choice of Cold, that means it will increase the blue tone for the white. But choosing the Warm, it will increase the red color for the white.

### Aspect Ratio

Allows you to watch the screen in various picture formats: Auto / 4:3 / 16:9 / Zoom1 / Zoom2.

### Advanced Settings

- Noise Reduction: Reduces the noise level of the connected device (Medium / Strong / Off / Weak).
- Dynamic Contrast: Adjusts the dynamic contrast (Medium / Strong / Off / Weak).

4. Press the **EXIT** button to exit menu.

## Sound management

1. Press the **MENU** button to display the main menu. Press the ◀▶ buttons to select **Sound** in the main menu, then press the ▼ or **OK** button, it will highlight the first option.
2. Press the ▲▼ buttons to select the option you want to adjust in Sound menu.
3. Press the ◀▶▲▼ buttons to change the following settings.

### TIPS:

- You can change the value of treble and bass when the sound is in Personal mode.
- You can press the **S.MODE** button on the remote control to change the Sound Mode directly.

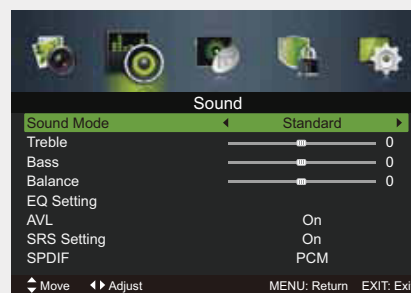

### Sound Mode:

Allows the selection of an audio-enhancement technical from among the following options: Standard, Music, Movie and Personal. You can change the value of Treble and Bass when the sound is in Personal mode.

### Treble

Controls the relative intensity of higher-pitched sounds.

### Bass

Controls the relative intensity of lower-pitched sounds.

### Balance

Adjusts the relative volume of the speakers in a multiple speaker system.

### EQ Setting

Allows the selection of an equalizer mode: Off / Rock / Pop / Jazz / User. You can change the EQ value under User mode.

### AVL

Selects to turn On/Off Audio Volume Leveler.

### SRS Setting

Selects to turn On/Off Surround Sound.

SRS TruSurround HD™ (TS HD) is a robust

# Basic Features

## Sound management (ATV / DTV Mode)

multichannel virtualisation technology developed by SRS Labs that provides an enhanced listening experience unlike any other technology that has been offered for a two speaker playback environment. TruSurround HD builds upon its predecessor, the industry leading surround sound virtualiser, SRS TruSurround XT®. Not only does TruSurround HD process up to 6.1 channels for playback over two speakers or headphones, but it also utilises additional proprietary algorithms from SRS Labs to optimise bass performance, for deep rich bass, dialogue clarity for better intelligibility of vocals, and definition control for maximum high-frequency clarity.

SRS TruSurround HD™ creates an immersive, feature-rich surround sound experience from two speakers, complete with rich bass, high frequency detail and clear dialogue.

TruSurround HD, SRS and the  symbol are trademarks of SRS Labs, Inc.

### SPDIF Mode

Select the digital audio output mode: Auto / Off / PCM.

### Audio Description

Selects to turn On/Off Audio Description.

### Stereo / Dual Sound Reception (ATV Mode)

When a programme is selected, press the **NICAM** button to display the sound information for the selected station.

Broadcast	On Screen Display
Mono	Mono
Stereo	STEREO
Dual	DUAL I, DUAL II, DUAL I+II

### Mono sound selection

If the stereo signal is weak in stereo reception, you can switch to mono by pressing the **NICAM** button. In mono reception, the clarity of sound is improved. To switch back to stereo, press the **NICAM** button again.

### Language selection for dual language broadcast

If a programme can be received in two languages (dual language), you can switch to DUAL I, DUAL II, DUAL I+II or Mono by pressing the **NICAM** button repeatedly.

DAUL I	Sends the primary broadcast language to the loudspeakers
DAUL II	Sends the secondary broadcast language to the loudspeakers
DAUL I+II	Sends the primary and secondary broadcast languages to the loudspeakers

## Channel management (ATV / DTV Mode)

### Auto Scan

Use this to automatically find and store all available channels. This is normally recommended if some channels have been added or removed by the broadcaster or you have moved house.

1. Press the **MENU** button to display the main menu. Press the **◀▶** buttons to select **Channel** in the main menu, then press the **▼** or **OK** button, it will highlight the first option.

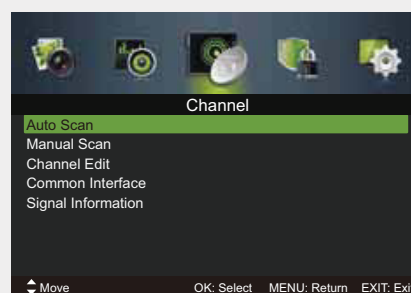

2. Press the **▲▼** buttons to select Auto Scan and then press the **OK** button to enter sub-menu.

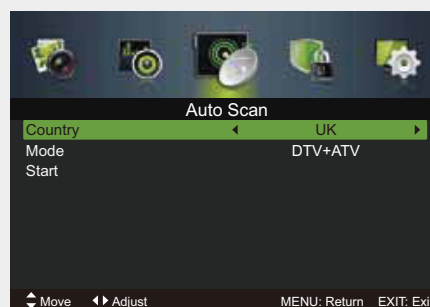

3. Press the **◀▶▲▼** buttons to navigate the menu and change the settings.

### Country

Selects the country where you will operate the TV.

### Mode

Selects the auto scan mode: DTV+ATV/DTV/ATV. (DTV mode)

### Start

Press the **OK** button to start auto tuning.

# Basic Features

## Channel management (ATV / DTV Mode)

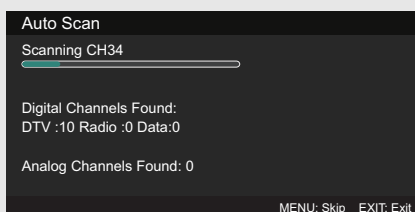

If you stop the tuning before it has finished, the TV will report a no signal error. This is normal because all previous channel memory has been cleared before tuning is carried out.

### Manual Scan (DTV Mode)

Allows you to make manual fine tuning adjustments to the channel under DTV mode.

1. Press the **MENU** button to display the main menu. Press the ◀▶ buttons to select **Channel** in the main menu, then press the ▼ or **OK** button, it will highlight the first option.

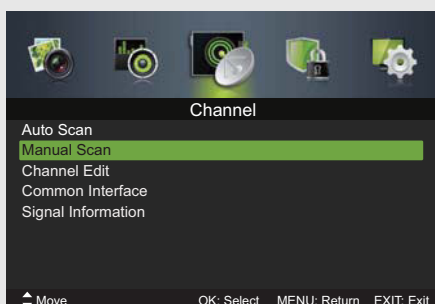

2. Press the ▲▼ buttons to select **Manual Scan** and then press the **OK** button. On the sub-menu, select Digital Manual Scan and then press the **OK** button.

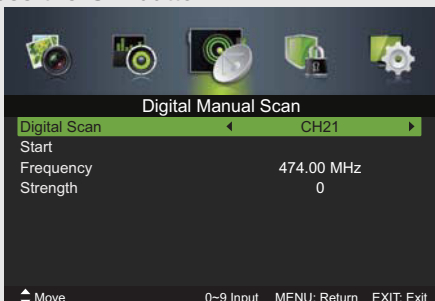

### Digital Scan

Press the ◀▶ buttons to select the desired channel.

### Start

Press the ▲▼ buttons to select Start and then press the **OK** button to start tuning.

### Manual Scan (ATV Mode)

Allows you to make manual fine tuning adjustments if the channel reception is poor under ATV mode.

1. Press the **MENU** button to display the main menu. Press the ◀▶ buttons to select **Channel** in the main menu, then press the ▼ or **OK** button, it will highlight the first option.

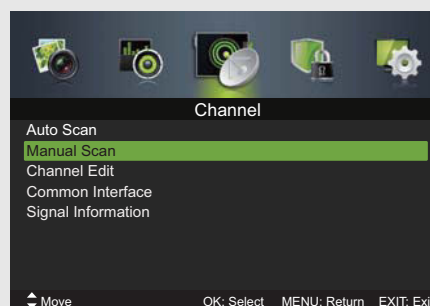

2. Press the ▲▼ buttons to select **Manual Scan** and then press the **OK** button. On the sub-menu, select Analog Manual Scan and then press the **OK** button.

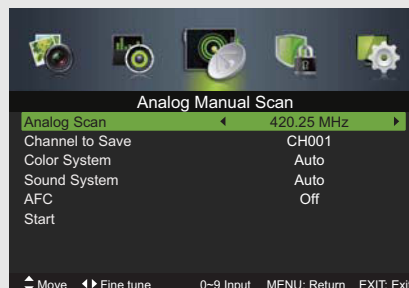

### Analog Scan

Displays the current frequency, press the ◀▶ buttons to change the frequency.

### Channel to Save

Press the ▲▼ buttons to select Channel to Save, press the ◀▶ buttons to select channel number you want to store.

### Color System

Press the ▲▼ buttons to select Color System, press the ◀▶ buttons to select: Auto / PAL.

### Sound System

Press the ▲▼ buttons to select Sound System, press the ◀▶ buttons to select: DK/I / BG.

### AFC

Press the ▲▼ buttons to select AFC, press the ◀▶ buttons to select On or Off.

### Start

Press the ▲▼ buttons to select Start, press the ◀▶ buttons to start tuning.

# Basic Features

## Channel management (ATV / DTV Mode)

### Channel Edit (DTV mode)

1. Press the **MENU** button to display the main menu. Press the **◀▶** buttons to select **Channel** in the main menu, then press the **▼** or **OK** button, it will highlight the first option.

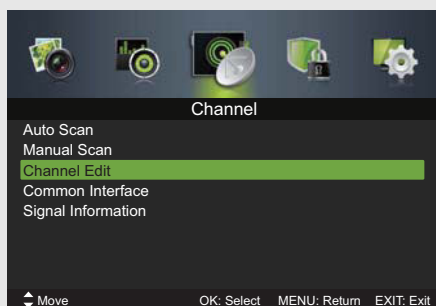

2. Press the **▲▼** buttons to select **Channel Edit** and then press the **OK** button to enter sub-menu.

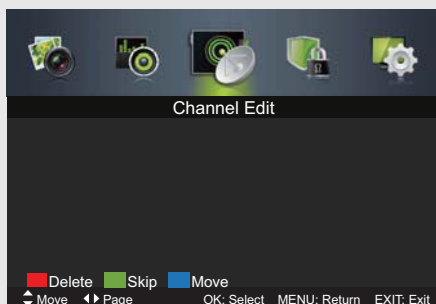

### Delete

Press the **RED** button to delete the selected channel.

### Skip

Press the **GREEN** button to select the channels that you want to skip when you are selecting channels. Press the **GREEN** button again to undo it.

### Move

Press the **BLUE** button and then press the **▲▼** buttons to move to the selected channel. Press the **BLUE** or the **OK** button to confirm.

### Channel Edit (ATV mode)

1. Press the **MENU** button to display the main menu. Press the **◀▶** buttons to select **Channel** in the main menu, then press the **▼** or **OK** button, it will highlight the first option.

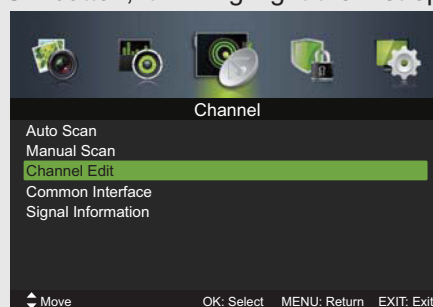

2. Press the **▲▼** buttons to select **Channel Edit** and then press the **OK** button to enter sub-menu.

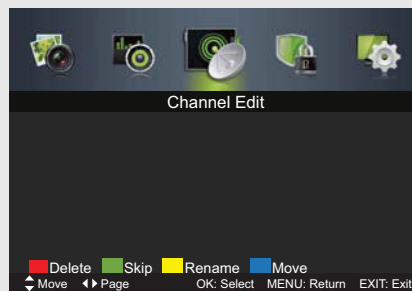

### Delete

Press the **RED** button to delete the selected channel.

### Skip

Press the **GREEN** button to select the channels that you want to skip when you are selecting channels. Press the **GREEN** button again to undo it.

### Rename

Press the **YELLOW** button to rename the selected channel. Press the **▲▼** buttons to select the characters to represent the station name. Press the **◀▶** buttons to move to the next character and then press the **OK** button again to confirm the new name.

### Move

Press the **BLUE** button and then press the **▲▼** buttons to move to the selected channel. Press the **BLUE** or the **OK** button to confirm. Press the **◀▶** buttons to select: Auto / PAL.

### Favorite List

Press the **FAV** button to display the Favorite List, press the **GREEN** button to set the channel that you are currently watching as one of the favorite programmes. Press the **RED** button to delete the selected channel.



# Basic Features

## Channel management (ATV / DTV Mode)

### Common Interface (DTV mode)

To view the module information.

1. Press the **MENU** button to display the main menu. Press the ◀▶ buttons to select **Channel** in the main menu, then press the ▼ or **OK** button.
2. Press the ▲▼ buttons to select **Common Interface** and then press the **OK** button.

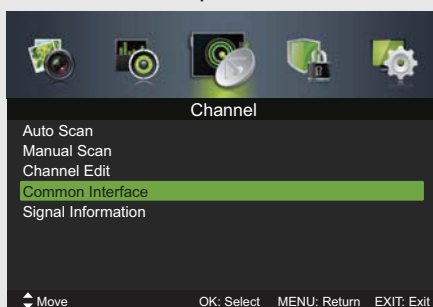

3. A Common Interface main menu will pop up. Press the ▲▼ buttons to select the items and press the **OK** button to confirm.

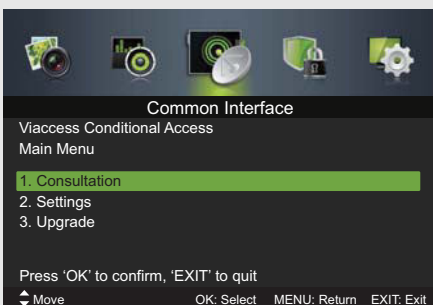

4. Press the **EXIT** button to exit the menu.

The common interface allows the use of a Common Access Module to enable you to view scrambled (pay to view) services. These services are provided by TopUp TV (UK only) and others. The Common Access Module and viewing card can be obtained from the service provider.



Do not repeatedly insert or remove the Common Access Module as this may damage the interface and cause a malfunction.

This feature is not available in all country.

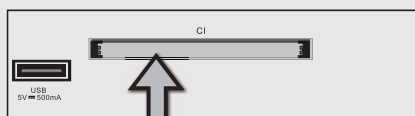

#### CI (Common Interface)

Allows the Common Access Module to be inserted and access the content that has been encrypted.

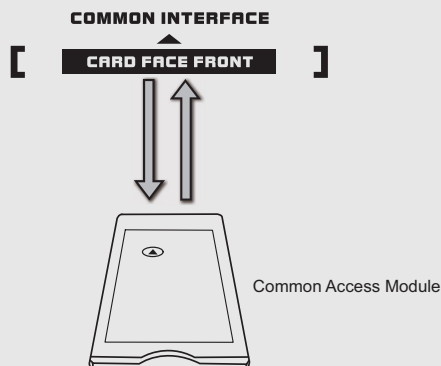

### To insert the Common Access Module

1. Before you insert the Common Access Module, ensure that the TV is switched off and the viewing card is inserted *in accordance with the Service Provider's instructions*.
2. Insert the Common Access Module into the slot. Flip the Common Access Module to another side and try again if you feel resistance.
3. Switch the TV on.

### To remove the Common Access Module

1. Before you remove the Common Access Module, ensure that the TV is switched off.
2. Pull the Common Access Module from the slot.
3. Switch the TV on.

### Signal Information (DTV mode)

1. Press the **MENU** button to display the main menu. Press the ◀▶ buttons to select **Channel** in the main menu, then press the ▼ or **OK** button.
2. Press the ▲▼ buttons to select **Signal Information** and then press the **OK** button to view the Signal Information..



3. Press the **EXIT** button to exit the menu.

# Basic Features

## Lock System management

1. Press the **MENU** button to display the main menu. Press the **◀▶** buttons to select **Lock System** in the main menu, then press the **▼** or the **OK** button, it will highlight the first option.
2. Use the **0-9** buttons to input a 4-digit password to enter the Lock System menu.
3. Press the **▲▼** buttons to select the option you want to adjust in Lock System menu.
4. Press the **▲▼◀▶** buttons to change the following settings.

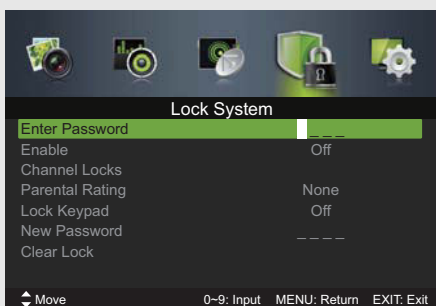

Default password "0000".

If you change the password, be sure to remember the new password! If you forget the new password, press the master password "8899".

### Enter Password

To access the Lock System menu, you must enter the password. Enter the default password "0000" for the first time use.

### Enable

The lock system is designed to prevent accidental returning of the TV/losing channels and prevent children watching unsuitable programme.

The Lock System must be set to On for this function to operate. If the Lock System is set to On, a valid password must be entered when you access Auto Scan / Manual Scan / Channel Edit / First Time Setup.

### Channel Locks

Channel Locks is designed to prevent children watching unsuitable programmes. When a channel is blocked, a valid password must be entered.

### Parental Rating

This function allows you to set up blocking schemes to block specific channels and ratings. Press the **◀▶** buttons to select an age rating: None, 4-18.

## Lock System management

### Lock Keypad

Key Lock is designed to prevent children from pressing the buttons on the TV. The Lock System must be set On for this function to operate.

### New Password

Use the **0-9** buttons to input the old password and then input the new 4-digit password. Re-enter new password for confirmation.

### Clear Lock

Reset all the lock settings to the factory defaults.

5. Press the **EXIT** button to exit the menu.

## Setup management

### OSD Language

1. Press the **MENU** button to display the main menu. Press the **◀▶** buttons to select **Setup** in the main menu, then press the **▼** or the **OK** button, it will highlight the first option.
2. Press the **▲▼** buttons to select **OSD Language** and then press the **◀▶** buttons to select your desired on-screen display language.

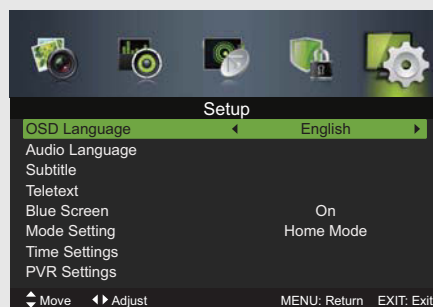

3. Press the **EXIT** button to exit the menu.



# Basic Features

## Setup management

### Audio Languages (DTV Mode)

1. Press the **MENU** button to display the main menu. Press the ◀▶ buttons to select **Setup** in the main menu, then press the ▼ or the **OK** button, it will highlight the first option.
2. Press the ▲▼ buttons to select **Audio Languages** and then press the **OK** button.

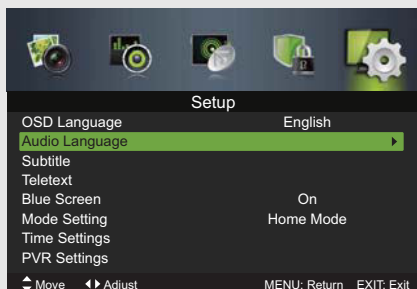

3. Press the ◀▶ buttons to select your desired Audio Primary Language. Press the ▼ button and then press the ◀▶ buttons to select your desired Audio Secondary Language.

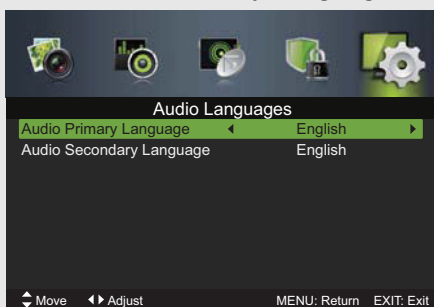

4. Press the **EXIT** button to exit the menu.

### Subtitle (DTV Mode)

1. Press the **MENU** button to display the main menu. Press the ◀▶ buttons to select **Setup** in the main menu, then press the ▼ or the **OK** button, it will highlight the first option.
2. Press the ▲▼ buttons to select **Subtitle** and then press the **OK** button to enter sub-menu.

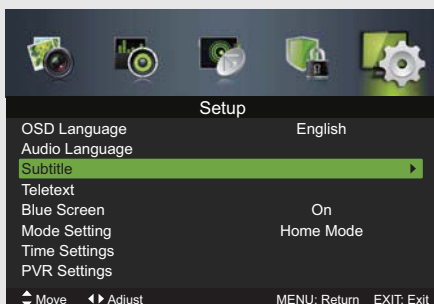

#### Mode:

Selects to turn On/Off subtitle language.

#### Subtitle Primary Language

Press the ◀▶ buttons to select your desired subtitle primary language.

#### Subtitle Secondary Language

Press the ◀▶ buttons to select your desired subtitle secondary language.

#### Hearing Impaired

Press the ◀▶ buttons to turn On/Off hearing impaired.

3. Press the **EXIT** button to exit the menu.

### Teletext

1. Press the **MENU** button to display the main menu. Press the ◀▶ buttons to select **Setup** in the main menu, then press the ▼ or the **OK** button, it will highlight the first option.
2. Press the ▲▼ buttons to select **Teletext** and then press the **OK** button.
3. Press the ◀▶ buttons to select your desired Digital Teletext Language. Press the ▼ button and then press the ◀▶ buttons to select your desired Decoding Page Language.

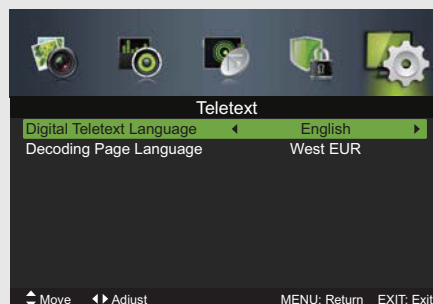

4. Press the **EXIT** button to exit the menu.

# Basic Features

## Setup management

### Blue Screen

1. Press the **MENU** button to display the main menu. Press the ◀▶ buttons to select **Setup** in the main menu, then press the ▼ or the **OK** button, it will highlight the first option.
2. Press the ▲▼ buttons to select **Blue Screen** and then press the ◀▶ buttons to select On / Off.

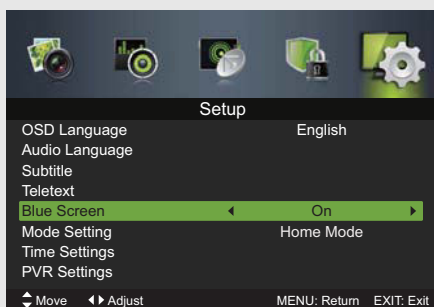

3. Press the **EXIT** button to exit the menu.

### Mode Setting

1. Press the **MENU** button to display the main menu. Press the ◀▶ buttons to select **Setup** in the main menu, then press the ▼ or the **OK** button, it will highlight the first option.
2. Press the ▲▼ buttons to select **Mode Setting** and then press the ◀▶ buttons to select your desired mode: Home Mode/Store Mode.
  - Home Mode: Viewing at home.
  - Store Mode: For store demo, the brightness is higher than home mode.

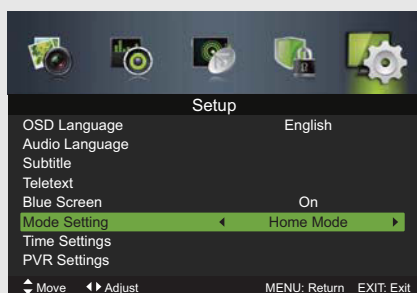

3. Press the **EXIT** button to exit the menu.

### Time Settings

1. Press the **MENU** button to display the main menu. Press the ◀▶ buttons to select **Setup** in the main menu, then press the ▼ or the **OK** button, it will highlight the first option.
2. Press the ▲▼ buttons to select **Time Settings** and then press the **OK** button.

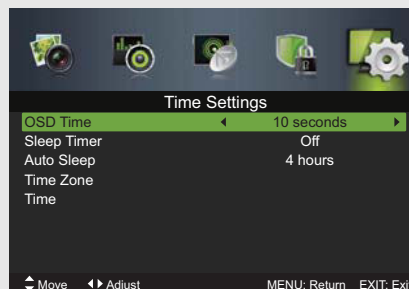

### OSD Time

Displays time of the on-screen menu: 10s/20s/30s/60s/Off.

### Sleep Timer

Press the ◀▶ buttons to select a period of time after which the TV automatically switches to standby mode: Off/5/15/.../120/240mins.

### Auto Sleep

The unit will automatically switch to standby mode 3/4/5 hours after the last time the remote control was used. If you want to operate the TV for a long period of time, turn off the auto standby function.

### Time Zone

Selects your desired Time Zone city.



# Basic Features

## Setup management

### Time

The clock is set automatically when receiving a digital signal or you can set it manually.

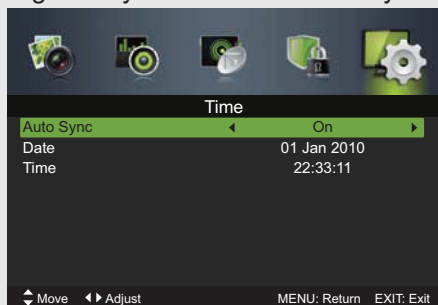

3. Press the **EXIT** button to exit the menu.

### PVR Settings

1. Press the **MENU** button to display the main menu. Press the **◀▶** buttons to select **Setup** in the main menu, then press the **▼** or the **OK** button, it will highlight the first option.
2. Press the **▲▼** buttons to select **PVR Settings** and then press the **OK** button.



3. Press the **◀▶** buttons to select the following PVR File System options and then press the **OK** button.

### File Manager

Select File Manager to display the recorded programme list, press the **▲▼** buttons to select the recorded programme and then press the **OK** or **▶||** button to view.

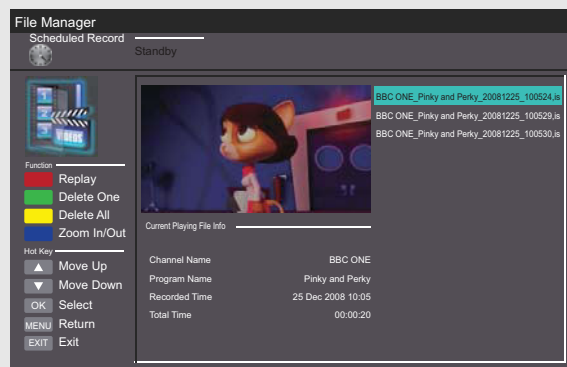

### Device List

Select Device List to check the information of the connected USB storage device for PVR. Press the **RED** button to format the selected USB device.

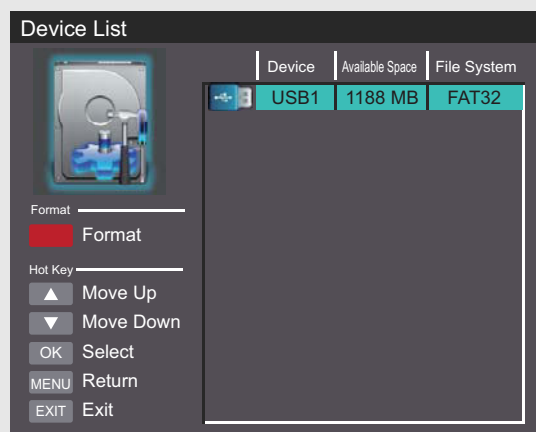

### Scheduled Record

Select Scheduled Record to view the scheduled recordings list.

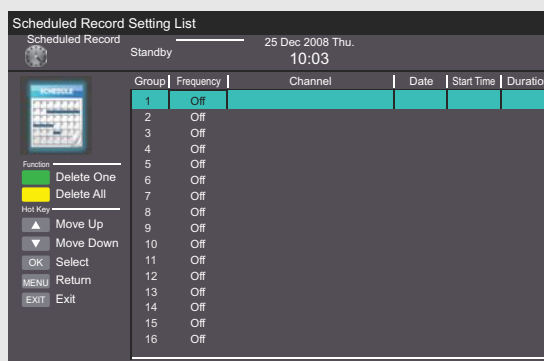

4. Press the **EXIT** button to exit the menu.

# Basic Features

## Setup management

### First Time Setup

1. Press the **MENU** button to display the main menu. Press the ◀▶ buttons to select **Setup** in the main menu, then press the ▼ or the **OK** button, it will highlight the first option.
2. Press the ▲▼ buttons to select **First Time Setup** and then press the **OK** button.

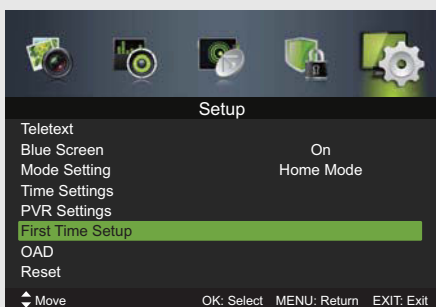

3. Press the ▲▼◀▶ buttons to navigate the menu and change the settings. Then it will search automatically for analog and digital TV programmes.
4. Press the **EXIT** button to exit the menu.

### OAD (Over Air Download)

1. Press the **MENU** button to display the main menu. Press the ◀▶ buttons to select **Setup** in the main menu, then press the ▼ or the **OK** button, it will highlight the first option.
2. Press the ▲▼ buttons to select **OAD** and then press the **OK** button.

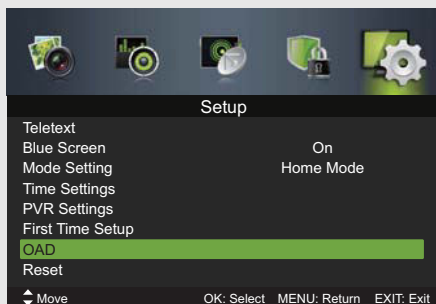

3. Press the ▲▼ buttons to select the over air download type.

### Manual OAD Download

The TV auto detects the latest firmware through the DTV signal and allows you to accept or refuse the firmware upgrade service.

### Auto Download

The TV auto detects the latest firmware through the DTV signal and upgrades the firmware automatically. Selects to turn On/Off auto OAD download.

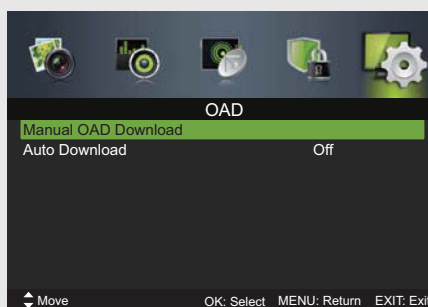

4. Press the **EXIT** button to exit the menu.

### Reset

1. Press the **MENU** button to display the main menu. Press the ◀▶ buttons to select **Setup** in the main menu, then press the ▼ or the **OK** button, it will highlight the first option.
2. Press the ▲▼ buttons to select **Reset** and then press the **OK** button.

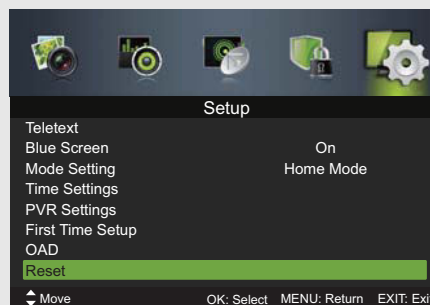

3. Press the ▲▼ buttons to select Yes or No on the screen. All settings will be reset to factory defaults and the Setup menu will disappear.

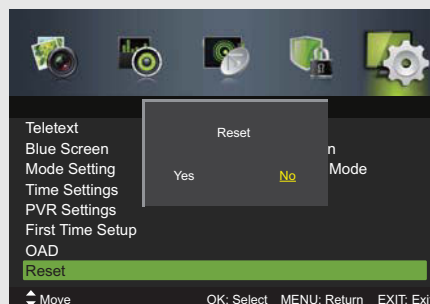

# Entertainment

## Entertainment

### Using the Features via USB Port

1. Switch off the TV before connecting any USB storage device.
2. Connect your USB storage device to the USB port of your TV.
3. Press the **⏻** button on the remote control to turn on your TV and your USB storage device.
4. Press the **SOURCE** button on the front of the TV or the **SOURCE** button on the remote control to display the Source List. Use the **▲** **▼** buttons to select USB and then press the **OK** button to confirm.

### Attention:

- Some versions of portable hard disk may require more power than the TV USB socket can provide. To ensure correct operation please use power adapter for that device.
- If a USB hub is used make sure its mains adapter is connected to the mains supply as the total current consumption exceed 500mA.
- The maximum supported storage space of the hard disk is 1 TB.
- The file system only support FAT32 format.
- If you want to store the video streaming of a DTV programme, the transfer rate of the USB storage device must not be less than 5MB/s, otherwise the picture and sound of the programme will be affected and a warning statement will be shown on the screen. If this happens, please upgrade your USB storage device.
- The TV screen will be blank temporarily as it will take time to start up and stabilize the connected hard disk. This is normal and the starting time may vary depending on the brand and the memory size of the connected hard disk.
- Disconnect the USB storage device if it is not in use.

### Viewing Photo

1. Press the **SOURCE** button on the front of the TV or the **SOURCE** button on the remote control then press the **▲▼** buttons to select the USB mode and then press the **OK** button.
2. Press the **◀▶** buttons to select **Photo** and then press the **OK** button.

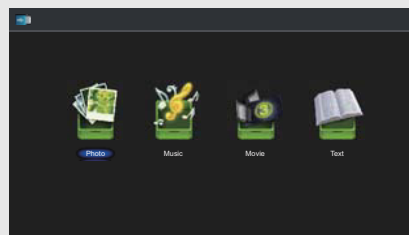

3. Press the **◀▶** buttons to select your storage device and then press the **OK** button.

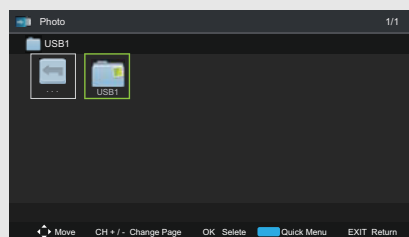

4. Press the **▲▼◀▶** buttons to navigate in the picture folder and then press the **OK** button. If you want to select the specified photos, press the **▲▼◀▶** buttons to select the picture file and then press the **OK** button.

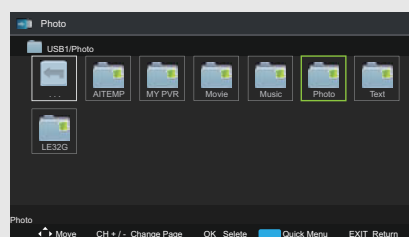
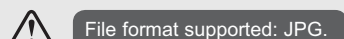

5. Press the **▶||** or **OK** button to view.

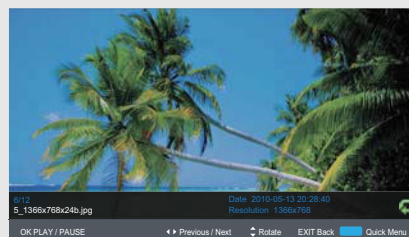

# Entertainment

## Entertainment

- Press the **OK** button or the **DISPLAY** button to display the function bar: Play / Pause / Previous / Next / Rotate / Quick Menu (Interval Time / Repeat / Slideshow Effect / Background Music).



If this folder also contains music files, you can select a music track to play at the same time you view your photos.

- Press the **EXIT** button to return to the previous menu.

### Listening to Music

- Press the **SOURCE** button on the front of the TV or the **SOURCE** button on the remote control then press the **▲▼** buttons to select the USB mode and then press the **OK** button.
- Press the **◀▶** buttons to select **Music** and then press the **OK** button.

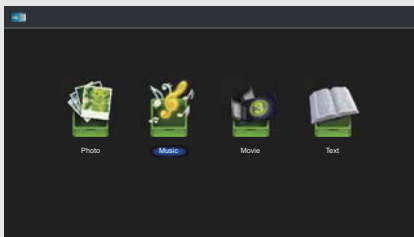

- Press the **▲▼** buttons to select your storage device and then press the **OK** button.

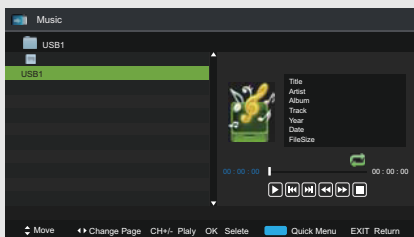

- Press the **▲▼** buttons to navigate in the music folder and then press the **OK** button. If you want to select the specified music, press the **▲▼** buttons to select the music file and then press the **OK** button.

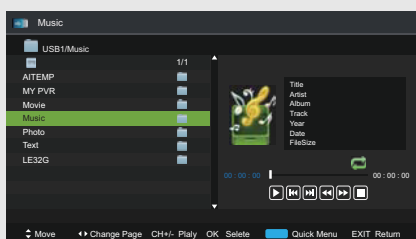

Some audio file formats will not be supported. Supported File format: MP3.

- Press the **▶||** or **OK** button to start to play.

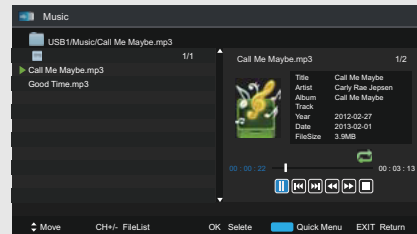

- Press the **◀▶** buttons and then press the **OK** button to select the function: Play / Previous / Next / FB / FF / Stop / Quick Menu (Repeat).
- Press the **EXIT** button to return to the previous menu.

### Viewing Movies

- Press the **SOURCE** button on the front of the TV or the **SOURCE** button on the remote control then press the **▲▼** buttons to select the USB mode and then press the **OK** button.
- Press the **◀▶** buttons to select **Movie** and then press the **OK** button.

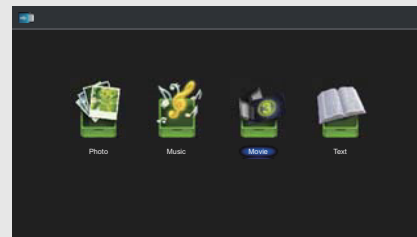

- Press the **▲▼** buttons to select your storage device and then press the **OK** button.

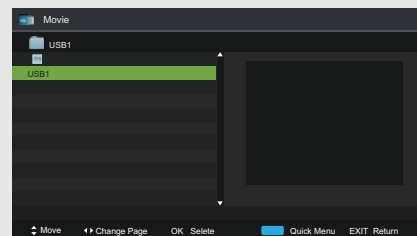

- Press the **▲▼** buttons to navigate in the movie folder and then press the **OK** button. If you want to select the specified movie, press the **▲▼** buttons to select the movie file and then press the **OK** button.



Some audio file formats will not be supported. Supported File format: MPEG 1/2.



# Entertainment

## Entertainment

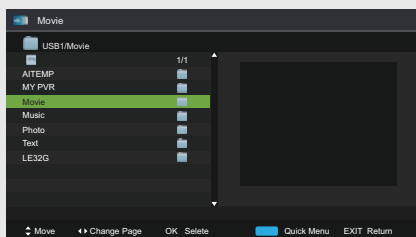

5. Press the **▶||** or **OK** button to view.

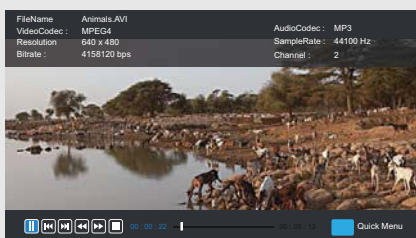

6. Press the **OK** button or the **DISPLAY** button to display the function bar. Press the **◀▶** buttons and then press the **OK** button to select the function: Pause / Previous / Next / FB / FF / Stop / Quick Menu (Repeat / Encode Type).

7. Press the **EXIT** button to return to the previous menu.

### My Text

1. Press the **SOURCE** button on the front of the TV or the **SOURCE** button on the remote control then press the **▲▼** buttons to select the USB mode and then press the **OK** button.
2. Press the **◀▶** buttons to select **Text** and then press the **OK** button.

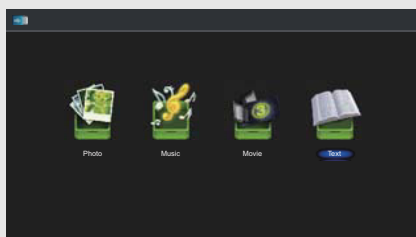

3. Press the **▲▼** buttons to select your storage device and then press the **OK** button.

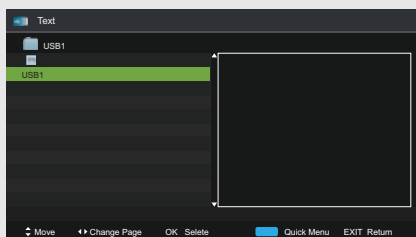

4. Press the **▲▼** buttons to navigate in the text folder and then press the **OK** button. If you want to select the specified text file, press the **▲▼** buttons to select the text file and then press the **OK** button.

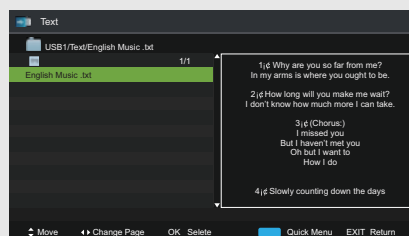
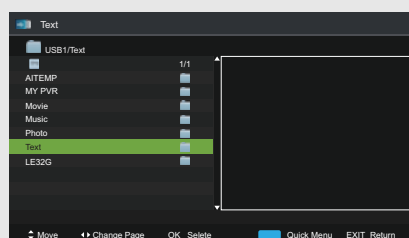

5. Press the **▶||** or **OK** button to view.

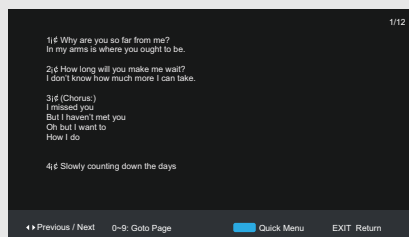

6. Press the **OK** button or the **DISPLAY** button to display the function bar. Press the **◀▶** buttons and then press the **OK** button to select the function: Previous / Next / Goto Page / Quick Menu (Repeat / Background Music / Encode Type).



If this folder also contains music files, you can select a music track to play at the same time you view your texts.

7. Press the **EXIT** button to return to the previous menu.

# Using the DVD Features

## Using the Built-in DVD Player

1. Insert a disc with the label side facing towards the rear of the TV. (CD-R, CD-RW, DVD-R, DVD-RW, CD, DVD+R, or DVD+RW) Allow 10 seconds for the player to load the disc. If you insert the disc wrongly, an error message will be displayed.

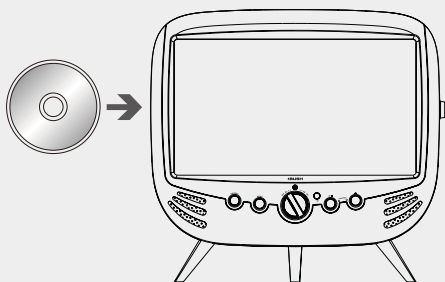

2. After the disc is inserted, the TV will change the input source to **DVD** automatically and Smart NAVI will show the content of the disc automatically.
3. If the DVD player does not automatically play the disc, press the **SOURCE** button on the front of the TV or the **SOURCE** button on the remote control to display the Source List. Use the **▲▼** buttons to select **DVD** and then press the **OK** button to confirm. Press the **▶▶** button on the unit or the **▶▶** button on the remote control to start playing.



4. Press the **▲** button if you want to remove the disc.



- Only insert 12cm discs. Do not insert or play 8cm discs; they will get stuck.
- Ensure disc is fully ejected before removing it, or else you risk damaging the DVD player.

## Compatible Disc Types

Disc Types	Disc Logo	Recorded Content
DVD-VIDEO (Digital Versatile Disc)		AUDIO + VIDEO
DVD±RW (Audio/Video format or JPEG files)		AUDIO + VIDEO + JPEG
DVD±R (DVD Recordable - Audio/Video format or JPEG files)		AUDIO + VIDEO + JPEG
CD-R (CD Recordable - Audio/Video format or JPEG files)		AUDIO + VIDEO + JPEG
CD-RW (CD-Rewritable - Audio/Video format or JPEG files)		AUDIO + VIDEO + JPEG
AUDIO-CD (Compact Disc Digital Audio)		AUDIO

### Supported Formats

#### JPEG

- The file extensions has to be .jpg and not .jpeg.
- Pictures encoding must comply with JPEG/ISO format.
- This DVD player can only display DCF-standard still pictures or JPEG pictures such as TIFF.

#### Region Code

Both the DVD player and the discs are coded by region. These regional codes must match in order to play the disc. If the codes do not match, the disc will not play.

The Region Number for this DVD player is described on the rear panel of the TV.

Disc Types	DVD-VIDEO
Region code	



# Using the DVD Features

## Basic DVD Playback Functions

### Playing the DVD

Depending on the disc, a menu may appear on the TV screen once the disc has loaded. When playing the disc, you may use the ►|| button to toggle between Play and Pause mode. This product also supports Menu / Title / Sequential / Programme Playback.

### Menu Playback (for DVD)

- For DVD discs, the screen will display the DVD Disc Menu (Root Menu).
- Press the ►|| button or the **OK** button to start from the highlighted content.
- Press the **DVD MENU** button to return to the Root Menu when playing the disc.
- For some DVD discs you may need to press the **DVD MENU** button or the **TITLE** button to display the Disc Menu.

### Stopping Playback

- Press the ■ button once to stop. Press the ►|| button to resume from where you stopped.
- Press the ■ button twice to stop. Press ►|| the button to start from the beginning.
- In order to protect the disc, press the ■ button twice and then press the ▲ button to eject the disc. When the disc is ejected, hold the disc edge slightly and remove it from the disc slot.
- When not using the DVD function (in stand-by-mode or using others modes for a long period of time), please take out the disc to protect the DVD loader and the disc.

### Previous / Next (for DVD / CD / Multimedia discs)

- Press the ◀◀ button to play the last Title / Chapter / Track.
- Press the ▶▶ button to play the next Title / Chapter / Track.



If the current track is the first one, pressing the ◀◀ button will restart the disc from the beginning.

If the current track is the last one, pressing the ▶▶ button will stop the playback.

- For DVD discs, the above functions may vary due to different DVD disc's structure.

### Forward / Backward (for DVD / CD / Multimedia discs)

- There are 4 speeds for forward. Press the ►► button to toggle between the different

forward options in sequence. (FORWARD x 2 / FORWARD x 4 / FORWARD x 8 / FORWARD x 20 / Play).

- Press the ►|| button to return to normal speed playback.
- For DVD discs, when selecting backward to first title / chapter, the disc will start from the beginning.



There will be no sound during forward or backward.

### Pause (for DVD / CD / Multimedia discs)

- For CD / JPEG discs, press the ►|| button to pause; press the ►|| button again to resume playback.
- For DVD discs, press the ►|| button to pause; press the ►|| button again to resume playback.

### Repeat (for DVD / CD / Multimedia discs)

Press the **REPEAT** button once to display the current repeat mode.

- For CD discs, while playing in sequence, you may use the repeat playback. There are 3 repeat modes, press the **REPEAT** button to toggle between the different repeat modes in sequence. (REPEAT (OFF) / REPEAT (1) / REPEAT (ALL)).
- For DVD discs, you may setup the repeat playback mode. There are 4 repeat modes, press the **REPEAT** button to toggle between the different repeat modes in sequence. (REP: (OFF) / REP: (CHAPTER) / REP: (TITLE) / REP:(ALL)).
- For MP3 / JPEG discs, while playing the disc, you may use the repeat playback. There are 4 repeat modes, press the **REPEAT** button to toggle between the different repeat modes in sequence. (REPEAT (OFF) / REPEAT (1) / REPEAT (DIR) / REPEAT (ALL)).

### Info (for DVD / CD / Multimedia discs)

Press the **DISPLAY** button to activate the on screen roll-down menu for the current Title, Chapter, Time and other information.

For DVD discs, press the button once to display the first page as shown below:

- For DVD discs, press the **DISPLAY** button once to display the first page as shown below:

2 / 23 1 / 1 Title Elapsed 00:02:56

# Using the DVD Features

## Basic DVD Playback Functions

- Press the **DISPLAY** button twice to display the second page as shown below:

: 2/23 : 1/1 Title Remain 00:01:42

- Press the **DISPLAY** button three times to display the three page as shown below:

: 2/23 : 1/1 Chapter Elapsed 00:03:05

- Press the **DISPLAY** button four times to display the four page as shown below:

: 2/23 : 1/1 Chapter Remain 00:01:33

### Aspect

Allows you to select the video size of programme stream.

- Press the **Aspect** button to select the size you want.

### Goto (for DVD / CD / Multimedia discs)

This function allows you to play your favourite Title / Chapter / Time. Press the **GOTO** button to activate the on screen scroll-down menu for selecting. Input your Title / Chapter / Time by pressing the **0-9** buttons or input the playback time. After editing, press the **OK** button to start. If the input is invalid, it will not function.



For some discs, only Time can be selected in the **GOTO** function

### Audio (for DVD / CD)

Press the **AUDIO** button to toggle between different audio modes in sequence.

- For CD discs: Stereo / MonoL / MonoR.



Some discs may contain multiple languages which can be selected by pressing the **AUDIO** button.

### Audio (for DVD / CD)

When playing DVD, CD disc, press the **A-B** button to repeat certain content. Press the **A-B** button on the start point (A) and the end point (B) to select the repeat part. Press the **A-B** button a third time to cancel the **A-B** button function and return to normal playback.

# Using the DVD Features

## Playing Multimedia Discs

After loading the multimedia disc, the disc contents will automatically be displayed and sorted by different file formats into Music / Picture / Video folders.

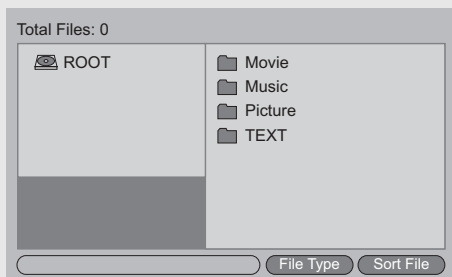

1. Press the ▲◀▶▼ buttons to navigate through the folders and files.
2. Press the 0-9 buttons to select the contents directly (for example, to select track 23, press the **LIST** button twice followed by 3).
3. When playing or pausing with picture playback, you may use the ▲◀▶▼ buttons to flip / rotate the picture.

## Using the DVD Language Setup Page

In the DVD mode, press the **SETUP** button on the remote control. Press the ▲▼ buttons to select the **Language Setup** menu, and then press the ◀▶ buttons to select the menu options. Press the **Setup** button to exit the menu.



In Setup mode, the disc playback function will not be available.

### OSD

Set the OSD language to your language of choice.



## Using the DVD Language Setup Page

### Menu

DISC MENU: Select the Disc Menu language.



The default language is English.



### Audio

Set the Audio language to your language of choice.



Not all DVD discs support multiple audio languages.



### Subtitle

Select the Subtitle language.



Not all DVD discs support multiple audio languages.



# Using the DVD Features

## Using the DVD Language Setup Page

### Encoding

Select the encoding of subtitle Western European or Central European.

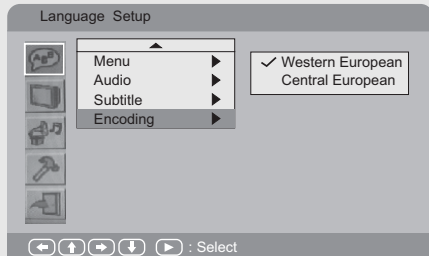

## Using the DVD Screen Setup Page

In the DVD mode, press the **SETUP** button on the remote control. Press the **▲▼** buttons to select the **Screen Setup** menu, and then press the **◀▶** buttons to select the menu options. Press the **Setup** button to exit the menu.



In Setup mode, the disc playback function will not be available.

### TV Type

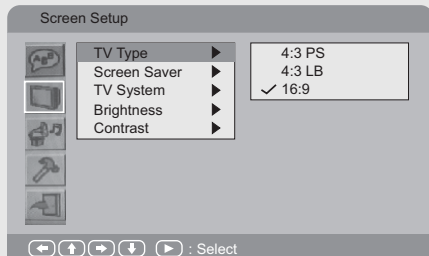

- **4:3 Pan Scan**

Widescreen picture shown in the full screen with some part cut.



- **4:3 Letter box**

Widescreen picture shown in the full screen with black bars on the top and bottom of the screen.

## Using the DVD Screen Setup Page



- **16:9**

Widescreen picture shown in the full screen.



### Screen Saver

When the player stops or the picture becomes motionless for a couple of minutes, there will be a screen saver to prevent damage to the display screen.

- **ON:** To activate screen saver.
- **OFF:** To disable screen saver.

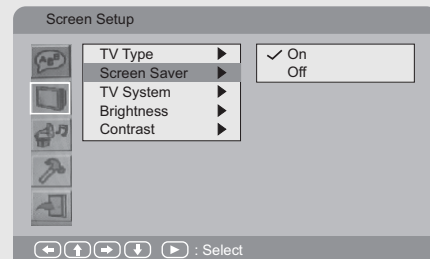

### TV System

In order for the disc to play, the colour system of the DVD player, disc and TV should match.

- **NTSC**  
This format is used by some other countries, e.g. USA.
- **PAL**  
This is the format used in UK.
- **AUTO**  
This format can be used if your TV / DVD is capable of both PAL and NTSC formats and this is the default setting.

# Using the DVD Features

## Using the DVD Screen Setup Page



PAL format is generally used for TV's in the UK. If NTSC is selected with a non-compatible television, you may experience interference or picture scrolling.

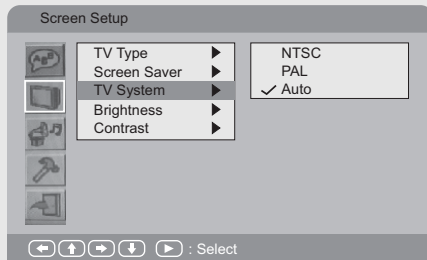

### Brightness

Select the Brightness of screen in DVD mode.

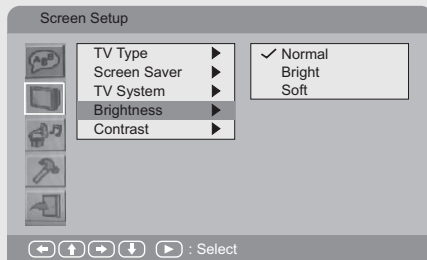

### Contrast

Select the Contrast of screen in DVD mode.

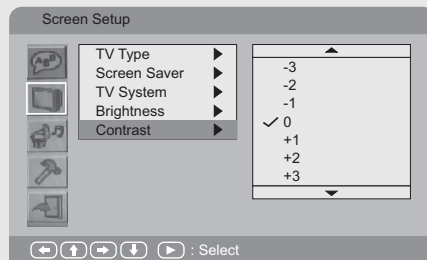

## Using the DVD Audio Setup Page

In the DVD mode, press the **SETUP** button on the remote control. Press the **▲▼** buttons to select the **Audio Setup** menu, and then press the **◀▶** buttons to select the menu options. Press the **Setup** button to exit the menu.



In Setup mode, the disc playback function will not be available.

### Downmix

- Lo/Ro: Mixed stereo surround output.
- Lt/Rt: Mixed stereo Lt/Rt output.



## Using the DVD Custom Setup Page

In the DVD mode, press the **SETUP** button on the remote control. Press the **▲▼** buttons to select the **Custom Setup** menu, and then press the **◀▶** buttons to select the menu options. Press the **Setup** button to exit the menu.



In Setup mode, the disc playback function will not be available.

### Parental Ctrl

Allows the user to set a maximum rating level for a movie that can be played (e.g. PG rating). Movies rated higher than the level set will not be played. The parental lock can only be changed after inputting the correct password.



This function is available only when the discs have ratings encoded on them.

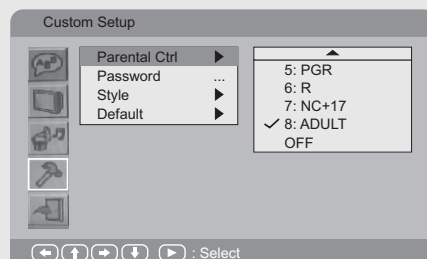

# Using the DVD Features

## Using the DVD Custom Setup Page

### Password

To change the password, you need to:

1. Input old password. (for initial use, please enter factory default password "8899")
2. Input a new 4 digit password and then press the **OK** button to confirm.



If you forget your DVD password, please enter the master password "8899".

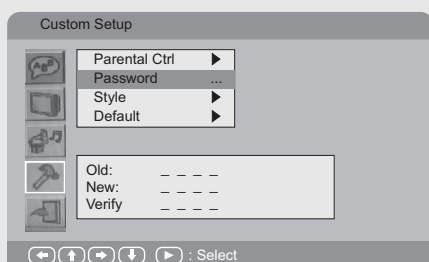

### Style

Select the Style of custom in DVD mode.

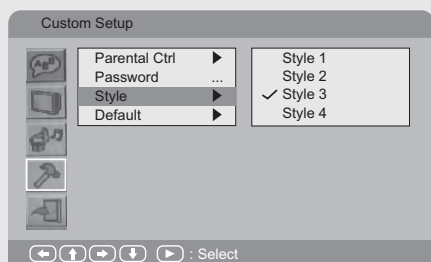

### Default

To restore all setup parameters to the factory settings EXCEPT the password.

This function is available in stop state or when the tray is opened.

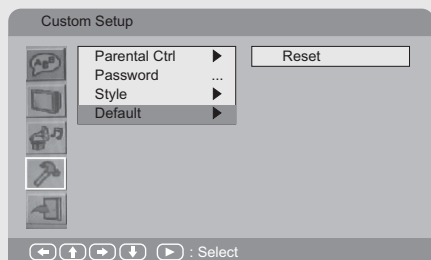

## Using the DVD Exit Setup Mode Page

In the DVD mode, press the **SETUP** button on the remote control. Press the **▲▼** buttons to select the **Exit Setup** menu, and then press the **◀▶** buttons to select the menu options. Press the **Setup** button to exit the menu.



In Setup mode, the disc playback function will not be available.

### Exit Setup Mode

Press the DVD Setup button to exit the menu.

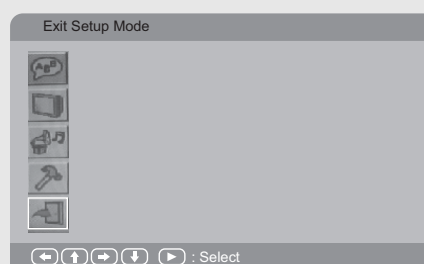

## Other Information

Specifications	
<b>TV Broadcasting</b>	PAL, B/G, D/K, I, SECAM, L/L'
<b>Receiving Channels</b>	VHF (BAND I/III) - UHF (BAND U) - HYPERBAND
<b>Number of Preset Channels</b>	100
<b>Channel Indicator</b>	On Screen Display
<b>RF Aerial Input</b>	75 Ohm (unbalanced)
<b>Operating Voltage</b>	AC 100-240V~ 50/60Hz
<b>Audio</b>	Nicam
<b>Audio Output Power (WRMS.) (10% THD)</b>	2 x 8 W + 15 W
<b>Dimensions DxLxH (with foot)</b>	289×584×541 mm
<b>Weight (with foot)</b>	8.5 kg
<b>Dimensions DxLxH (without foot)</b>	270×584×470 mm
<b>Weight (without foot)</b>	8.4 kg
<b>Energy Consumption Data</b>	EEI B
<b>On Mode Power Consumption (W)</b>	27W
<b>Standby Mode (W)</b>	0.35W
<b>Maximum Power (W)</b>	50W
<b>Standby Mode</b>	After 4 Hours

### Digital reception

MHEG-5 ENGINE compliant with ISO/IEC 13522-5 UK engine Profile 1 - for UK
Object carousel support compliant with ISO/IEC 135818-6 and UK DTT profile - for UK
Frequency range: 474-850 MHz for UK models
170-862 MHz for EU models
Transmission standard: DVB-T. MPEG-2
Demodulation: COFDM with 2K/8K FFT mode
FEC: all DVB modes
Video: MP@ML, PAL, 4:3/16:9
Audio: MPEG Layer I&II 32/44.148kHz.

We apologise for any inconvenience caused by any minor inconsistencies in these instructions, which may occur as a result of product improvements and development.



# Other Information

## Energy label

This is called the product Fiche – the information needs to be presented in the following order, also this maybe in the form of a copy of the label, in colour or black and white – the label however must display all the information below:

- Supplier's name or trade mark
- Supplier's model product model no.
- The energy efficiency class of the model
- The visible screen diagonal in centimetres and in inches
- The on-mode power consumption
- The annual energy consumption
- The screen resolution in physical horizontal and vertical pixel count

# Product Support

## Trouble shooting

### Image persistence - ghosting

Please note that ghosting may occur while displaying a persistent image (still or paused image). LCD TVs' image persistence may disappear after a short time. Try turning off the TV for a while. To avoid this, do not leave the screen in still picture mode for extended periods.

### No power

If your TV has no power, please check the power cord plug is connect to the mains power socket.

### Poor picture

1. Have you selected the correct TV system?
2. Is your TV or house aerial located too close to a non-earthed audio equipment or neon lights, etc.?
3. Mountains or high buildings can cause double pictures or ghost images. Sometimes you can improve the picture quality by changing the direction of the aerial. Is the picture or teletext unrecognisable?
4. Check if you have entered the correct frequency.
5. Please retune the channels.
6. The picture quality may degrade when two devices are connected to the TV at the same time. In such a case, disconnect one of the devices.

### No picture

1. No Picture means that your TV is not receiving a transmission. Have you selected the correct button on the remote control? Try once more. Also make sure the correct input source has been selected.
2. Is the aerial connected properly?
3. Are the plugs connected tightly to the aerial socket?
4. Is the aerial cable damaged?
5. Are suitable plugs used to connect the aerial?
6. If you are in doubt, consult your dealer.

### No sound

1. Has the TV been set to mute? To cancel mute, press the "M" button, or increase the volume level.
2. Sound is coming from only one speaker. Is the balance set to one extreme?

### Remote control - does not operate

Your TV no longer responds to the remote control. The batteries may be exhausted, if so you can still use the control buttons on the left side of the TV.

### Input sources - can not be selected

1. If you cannot select an input source, it is possible that no device is connected.
2. Check the AV cables and connections if you have tried to connect a device.

### The DVD picture quality is poor

1. Make sure the DVD disc surface is not damaged (no scratches, fingerprints etc.).
2. Clean the DVD disc and try again. See instructions in "Cleaning Discs" to clean your disc properly page 00.
3. Ensure that the DVD disc is in the loader with the label facing you when looking at the TV screen.
4. A damp DVD disc or condensation may effect the equipment. Wait for 1 to 2 hours in Stand-by mode to dry the equipment.

### The Disc does not play

1. No disc in the machine - Place a disc into the loader.
2. Disc is incorrectly loaded - Ensure that the DVD disc is in the loader with the label facing you when looking at the TV screen.
3. Wrong type of disc. The DVD player cannot play CD-ROMS etc.
4. The region code of the DVD disc must match the player.

### Wrong OSD language

1. Select the language in the setup menu.
2. The language for the sound or subtitles on a DVD disc cannot be changed.
3. Multilingual sound and/or subtitles are not recorded on the DVD disc.
4. Try to change the sound or subtitles using DVD's title menu. Some DVD's do not allow the user to change these settings without using the disc's menu.

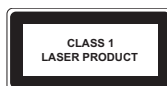

# Product Support

## Definition of terms

### Angle

Recorded onto some DVD discs are scenes, which have been simultaneously shot from a number of different angles (the same scene is shot from the front, from the left side, from the right side, etc.). With such discs, the ANGLE button can be used to view the scene from different angles.

### Chapter Number

These numbers are recorded on DVD discs. A title is subdivided into many sections, each of which are numbered, and specific parts of video presentations can be searched quickly using these numbers.

### Chapter Number

This refers to a high-density optical disc on which high-quality pictures and sound have been recorded by means of digital signals. Incorporating a new video compression technology (MPEG II) and high-density recording technology, DVD discs enable aesthetically pleasing full-motion video to be recorded over long periods of time (for instance, a whole movie can be recorded).

DVD discs have a structure consisting of two 0.6mm thin discs, which are adhered to each other. Since the thinner the disc, the higher the density at which the information can be recorded, a DVD disc has a greater capacity than a single 1.2mm thick disc. Since the two thin discs are adhered to each other, there is the potential to achieve double-sided play sometime in the future for even longer duration play.

### Subtitles

These are lines of text appearing at the bottom of the screen, which translate or transcribe the dialogue.

They are recorded on the DVD discs.

### Time Number

This indicates the playtime, which has elapsed from the start of a disc or a title. It can be used to find a specific scene quickly. (Not all discs permit the time search feature to be used. Availability is determined by the disc's manufacturer.)

### Title Number

These numbers are recorded on DVD discs. When a disc contains two or more movies, these movies are numbered as title 1, title 2, etc.

### Track Number

These numbers are assigned to the tracks, which are recorded on Audio CDs. They enable specific tracks to be located quickly.

### Dolby Digital

Many movie theatres are equipped with 5.1 channel surround systems. This same type of technology is available to you in your home. To enjoy full 5.1-channel surround, your DVD player must be connected to an external Dolby Digital decoder via the digital outputs (either coaxial or optical).

### Dolby Pro Logic

This is Dolby Laboratories' technology to decode Dolby Surround encoded programs actively. Dolby Surround programs have four channels of audio (Left, Centre, Right and Surround) encoded into a standard 2-channel stereo signal. The rear channel is monaural.

### LPCM

LPCM stands for Pulse Code Modulation and is digital audio.

### MPEG

Short for Moving Picture Experts Group. This is an international standard for compression of moving images. On some DVDs digital audio has been compressed and recorded in this format.

# Product Support

## Supported file formats

Media	File Extension	Format		Supported (Maximum resolution/Bit rate etc.)
		Video	Audio	
Movie	.mpg/.dat/.vob	MPEG1	MPEG Layer 1/2/3	
		MPEG2	MPEG2	
		MPEG2	MPEG2	
Music	-	-	PMC	Sample Rate: 8K ~ 48KHz
	.mp3	-	MPEG 1/2 Layer 1/2/3 MP3)	Sample Rate: 8K ~ 48KHz, Bit Rate: 64K ~ 320Kbps
Photo	.jpg	Baseline JPEG		W x H = 8192 x 8192 up to 77 Mega-pixel Support format: 444/ 440/ 422/ 420/ Grayscale
		Progressive JPEG		Up to 4 Mega-pixel Support format: 444/ 440/ 422/ 420/ Grayscale

## Disposal information

### Instructions for waste disposal:

Packaging and packaging aids are recyclable and should principally be recycled. Packaging materials, such as foil bag, must be kept away from children.

The cold cathode fluorescent lamp in LCD PANEL contains a small amount of mercury; please follow the local laws or regulations for disposal.

### Information for Users on Disposal of old Equipment and Batteries (European Union only)

These symbols indicate that equipment with these symbols should not be disposed of as general household waste. If you want to dispose of the product or battery, please consider the collection systems or facilities for appropriate recycling.

### Information for Users in European Union Countries

This symbol on the product or on its packaging means that your electrical and electronic device should be disposed of at the end of its service life separately from your household wastes. There are separate collection systems for recycling in EU.

**Notice:** The sign Pb below the symbol for batteries indicates that this battery contains lead.



Products



Battery

For more information, please contact the local authority or the dealer where you purchased the product.





## PRODUCT GUARANTEE

This product is guaranteed against manufacturing defects for a period of



Year

This product is guaranteed for twelve months from the date of original purchase. Any defect that arises due to faulty materials or workmanship will either be replaced, refunded or repaired free of charge where possible during this period by the dealer from whom you purchased the unit.

The guarantee is subject to the following provisions:

- The guarantee does not cover accidental damage, misuse, cabinet parts, knobs or consumable items.
- The product must be correctly installed and operated in accordance with the instructions contained in this manual.
- It must be used solely for domestic purpose.
- The guarantee will be rendered invalid if the product is re-sold or has been damaged by inexpert repair.
- Specifications are subject to change without notice.
- The manufacturer disclaims any liability for the incidental or consequential damages.
- The guarantee is in addition to, and does not diminish your statutory or legal rights.

Guarantor: Argos Ltd  
489 - 499 Avebury Boulevard  
Central Milton Keynes  
MK9 2NW